

JUNG



KNX[®]

The intelligent system
for smart buildings

The KNX bus system is a building management system with a control bus system tailored to suit the electrical installations. Leading European companies in electrical installation engineering – including JUNG – founded an organisation with the aim to achieve a standardisation of the system and widespread acceptance of the KNX in Europe and worldwide. KNX is a "Societe Coopérative" under Belgian law with its headquarters in Brussels. The trademark KNX visually underlines the system compatibility of the products.



The purpose of the organisation is to promote building management systems in a standardised form on the European market, to achieve fast, widespread market acceptance and develop the trademark to a seal of quality. Technical guidelines for the system and the products, together with quality regulations will be drawn up by the company accordingly. This will ensure that KNX bus equipment from various manufacturers within a system can communicate with each other.

The KNX system

The demands made on modern electrical installations in private homes and on business premises have changed considerably. More and more emphasis is being placed on safety, operational ease and flexible use. The limits for conventional-electrical installations with a confusing number of own functional networks for electrical power, heating, lighting and shutter control, burglar alarm system, smoke, gas and fire detectors, however, have long been reached.

Installation and power costs have risen. Subsequent upgrading, renovation and change of system operation is expensive and complicated. The KNX System offers a convincing perspective. The KNX System is an intelligent building management system for measuring, regulating, switching, controlling, signalling and monitoring. Laid additionally to the power supply network, information transmission is via a bus line suitable for all specific applications. This electronic control system does not require a central unit as it is located decentralized in every individual appliance. All consumers connected to this mutual bus line, such as switches, sensors, actuators, displays, control units etc. can exchange information via this communication line which can also be compiled logically for evaluation.

The bus line can be laid in line, star or tree structure. All devices can be selected freely and are interactive. The information transmission can contain analog functions (temperature, time, quantity etc.) and digital functions (yes/no, on/off, light/dark, warm/cold, long/short, more/less). Dimmer functions are of course also possible.

The advantages of the KNX System

1. Flexible planning and simple installation
2. Reduction of 230 V line lengths
3. Reduction of fire load
4. Power saving
5. Fast adaptation and high flexibility for change of usage
6. Problem-free enlargement
7. Intercommunication capabilities
8. No central unit required

JUNG



Backbone

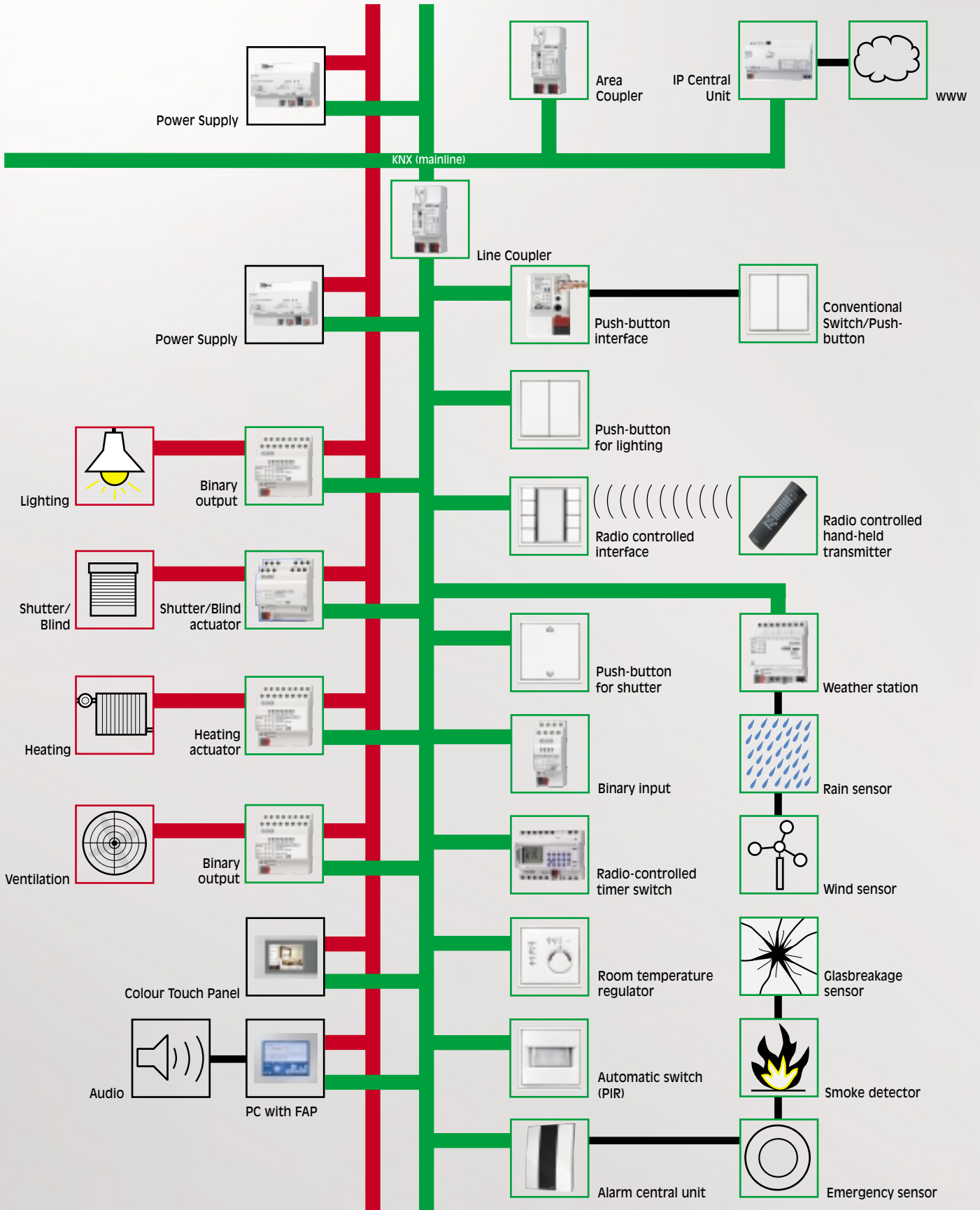

The JUNG KNX System

With KNX, all devices are linked to the system and can communicate with each other. The devices send telegrams along the bus line.

These are coupled with an address number and can only be processed by the specified recipients with this address number. More than one recipient can be addressed simultaneously with this address so that it is possible to form groups. The recipient(s) receive(s) the telegram and decode(s) the message which in the end contains a command – e.g. to switch on/off or dim. Once the command has been carried out, a variation of this can be sent back to the sensor by actuator as confirmation that the command has been carried out. The complete KNX system is split up into lines. A maximum of 64 devices can be connected to each line. Up to 12 lines are connected to the main line by line couplers. The maximum length per line is 1000 m. The lines can be laid in line, star or tree form. The bus management is designed on a multi-master principle, i.e. a central unit is not necessary. The decentralized access system CSMA/CA (carrier sense multiple access/collision avoidance) ensures fault-free operation of the bus system.

Important signals are assigned greater priority to ensure faster, preferential processing of the telegrams. Priorities, devices address, functions etc. are drawn up on a PC using planning software. The program is loaded into the system locally by personal computer. The use of an intelligent building installation system is recommended particularly in those areas where all demands on an optimised installation have to be fulfilled with a maximum degree of flexibility and comfort and a minimum of expenditure.

Heating, ventilation and air-conditioning systems, detection and alarm systems, light and blind/shutter control and load management can be combined and integrated. The same also applies for the "normal" installations which, with their multifunctional structure, can be designed with much greater flexibility and ease.

Recommendation: the prophylactic installation of a bus line. The decisive advantage of using an KNX System becomes very apparent at the latest when additional installations are required. Practically all required additional functions can be achieved with the lowest possible wiring and a minimum of line materials. The use of higher ranking bus systems (e.g. backbone bus) makes it possible to equip large industrial and administrative buildings with the JUNG KNX System as well.

The most important components and terminology

1. **Power supply/choke** supplies the necessary operating voltage for the connected KNX system equipment via the bus line.
2. **Sensors** provide information such as switch commands or physical measured quantities in telegram form via the bus line to the receiver devices (actuators).
3. **Actuators** receive telegrams sent by the sensors and convert the incoming commands into action (e.g. switching or dimming).
4. **Line couplers**
Equipment units which combine bus lines with each other and forward telegrams to other bus lines or limit to specific lines.

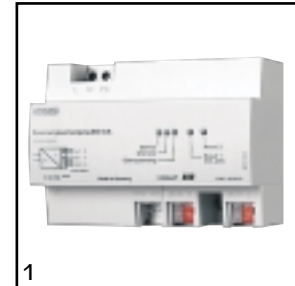

1

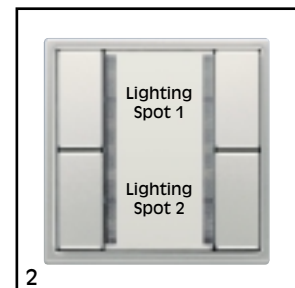

2

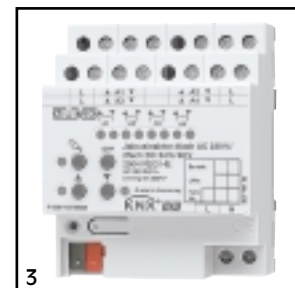

3

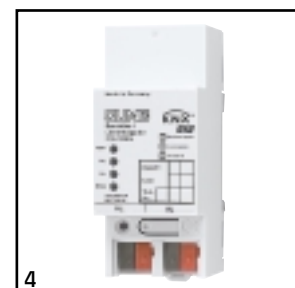

4



Blind/shutter control

The automatic lowering of blinds/shutters according to room temperature avoids the room being heated up unnecessarily. The control can be central and decentral. Blinds/shutters mounted outside, are protected against damage from high winds by wind sensors which, coupled with the blind/shutter control, prevent or initiate lowering or raising.

Lighting control units can be controlled centrally and decentrally. The illuminance can be reduced by switching off or dimming at programmed times (breaks, weekends, end of working day, company holidays etc.) or according to the room or outside brightness. This saves energy and reduces operating costs as well.

New requirements can be met quickly and safely by reparametering if room usage has been changed. Of course, comfortable light scene controls as well

as a fully automated partition wall lighting control can be realised.

Heating, ventilation and air-conditioning systems

The reduction of the temperature in rooms not in use (meeting/conference rooms) is controlled by motion detectors. Time-dependent control of the room temperature also saves energy (e.g. at weekends and public holidays). A coupling with the blind/shutter control is recommended anywhere where there is



Blind/shutter control



Monitoring and alarm installations



Lighting control



Entertainment



Heating, ventilation and air-conditioning systems



Interfaces

direct sunlight as this prevents the room from heating up extremely resulting in additional demands on the air-conditioning system. Displays allow constant control of current temperatures.

Monitoring and alarm installations

Using sensors (door and window contacts), monitors or displays indicate which building openings are open and which are closed. Locking can be initiated electromechanically. Faults in the parts of the building or system are also displayed and documented by printer.

This ensures that the complete building's installations are monitored.

Entertainment

There is and increasing desire to combine home and building automation with streaming of digital music. This integration is also known as audio multi-room multi-source application. For instance lighting and music control can be integrated in scenes, which can be selected at the push of a button from anywhere in the building. Audio streams are transmitted over Ethernet or wireless (IEEE 802.11)

networks from a server with the open-source software to music players, and in turn controlled by the visualisation package Facility-Pilot. Supported audio streams are for instance Internet Radio, MP3, WAV and Ogg Vorbis.

Interfaces enable the coupling of personal computers (PC's) or neighbouring bus systems to the instabus bus systems. PC's for programming or service purposes and printers for documentation can be connected using RS 232 (V24) interfaces.

One system for all functions

ADVANTAGES/BENEFITS

Convenience

- automatic control
- sensor technology
- central operation via visualisation/ panelboards of the master key system
- time-dependent control using clocks
- remote control
- telephone connection

In the following areas of application

- lighting
- security
- sun protection
- shutters
- heating
- ventilation

Functional reliability

- central, electronic master key system
- coded keys
- alarm functions
- time-dependent control
- presence simulation
- telephone connection

EMOTIONAL ASPECTS

Feeling of safety

- central combination of the functions
- automatic lighting control using observer/automatic switch/timer
- shutters/security grilles etc.
- sensor technology, door/window contacts, humidity/wind sensor
- missing keys are disabled (with an electronic master key system)

Comfort

- individual temperature settings
- sun protection
- controlled ventilation
- visual protection with shutters and blinds
- lighting aspects, light scenes, localised lighting

ECONOMICAL ASPECT

- automatic and interconnected building functions enable a reduction in energy consumption

The functions that are described can be used both in residential and functional buildings.

Entering the building:

The master key system automatically triggers the following functions:

Information is displayed on mini panelboards

- key recognition, name
- the occupants of the building

Alarm functions are switched off

- observer is disabled
- automatic switch is disabled

Shutters are raised

- can each be controlled manually

Room lighting can be switched/dimmed

- automatic brightness control
- individual lighting

Textile sun blinds in operation

- automatic control via sun sensors
- in the event of wind or rain, blinds are automatically retracted using sensor technology
- individual manual intervention

Individual room control

- from night reduction to individual temperature settings
- when the windows are opened, a reduction in the temperature is automatically triggered by the window contacts

Skylights

Ventilation

Leaving the building:

The master key system automatically triggers the following functions:

Triggering of central functions via a coded key

Alarm functions when system is set

- observer is enabled
- automatic switch
- window contacts are included
- alarm signals via telephone

Shutters are closed

Room lighting is switched off

Textile sun blinds are retracted

Individual room control

- night reduction

Skylights are closed

Ventilation is switched off

Reference: Haus Lämmerbuckel

The training centre of Daimler Chrysler is equipped with the JUNG KNX system.



With the Facility Pilot the entire building with all its technical functions is controlled and displayed.



In the conference rooms the individual control of lighting, heating and blinds is realised with room controller displays in the range LS 990 white.



The same control via room controller displays is also applied in the guest rooms of the training centre.



Contents

	Device	Ref.-No.	Page
Introduction	Functionality and terminology of KNX		1
Introduction	Features of the KNX system		1 – 6
	Terminology		7
	Applications		8
System Devices	Power supply 640 mA	2002 REG	12
	Power supply 320 mA	2005 REG	14
	Uninterrupted power supply 640 MA	USV 640 MA	16
	Lead-geld battery	BGA 12 AH	18
	Cable set basis	KSB 4	19
	Cable set extension	KSE 2	19
	Line coupler	2142 REG	20
	Bus coupling unit (BCU)	2070 U	22
	Logic module	2145 REGX	23
	Data interface for SE installation (RS232)	2131 REG	24
	Data interface flush mounted (RS232)	2130	25
	Data interface for SE installation (USB)	2130 USB REG	26
	Data interface for flush mounted (USB)	2130 USB, IPR 100 REG (full)	27
Sensors	Push-button 1- + 2-gang – standard	307x TSM	30
Push-Buttons	Push-button 3-, 4- + 8-gang – standard	307x TSM	32
	Push-button 1- ... 4- + 8-gang – universal	309x TSM	33
	Push-button x-gang – standard, CD 500	.. 207x NABS..	42
	Push-button x-gang – standard, LS-design	.. 207x NABS..	45
	Push-button x-gang – standard, A/AS-design	A 207x NABS..	48
	Push-button x-gang – universal, CD 500	.. 209x NABS..	50
	Push-button x-gang – universal, LS-design	.. 209x NABS..	53
	Push-button x-gang – universal, A/AS-design	A 209x NABS..	56
	Light scene push-button, CD 500	.. 2094 LZ..	58
	Light scene push-button, LS-design	.. 2094 LZ..	58
	Light scene push-button, A-design	A 2094 LZ..	59
	Push-button 4-gang – universal, radio-controlled		
	CD 500	.. 2094 F..	61
	LS-design	.. 2094 F..	61
Push-Buttons BCU	Push-button BCU 1-gang, switch position	2071.01 LED	65
	Push-button BCU 1-gang, neutral position	2071.02 LED	65
	Push-button BCU 2-gang, switch position	2072.01 LED	66
	Push-button BCU 2-gang, neutral position	2072.02 LED	66
	For the corresponding rockers see general Export catalogue.		
	Push-button BCU, WG 800, IP 44	807x LED W	68
Room Controller	Room controller display RCD 3-gang	RCDx 2021..	72
	Room controller display RCD 4-gang	RCDx 2022..	72
	Room controller display RCD 5-gang	RCDx 2023..	72
	Room controller display RCD 6-gang	RCDx 2024..	72
	Room controller display RCD 8-gang	RCDx 2044..	72
	FD Room controller display RCD 4-gang	RCDx 3094 M..	80
	FD Room controller display RCD 6-gang	RCDx 3096 M..	80

Device	Ref.-No.	Page	
PIR automatic switch 180°, standard	3180/3280	82	Physical sensors
PIR automatic switch 180°, comfort	3180-1 A/3280-1 A	85	
Presence detector, standard	3360	89	
Presence detector 360°, universal	3360-1	91	
Brightness sensor, 3 channel	2160 REG	97	
Room temperature controller	2178	100	
Room temperature controller with integrated push-button interface	2178 TS	101	
Room autostat			
with integrated push-button interface	2178 ORTS	101	
Push-button interface, 2-gang	2076-2 T	105	Binary inputs
Push-button interface, 4-gang	2076-4 T	105	
Binary input universal, 4-gang, 110 – 230 V	2114 REG	107	
Binary input universal, 8-gang, 110 – 230 V	2118 REG	107	
Binary input universal, 6-gang, 24 V	2126 REG	109	
Analog input, 4-gang	2114 REG A	116	Analog inputs
Weather Station	2224 REG W	119	
Analog input, extension modul, 4-gang	2214 REG AM	124	
Power supply for weather station and analog input	WSSV 10	125	
Combi sensor	WS 10 KS	126	Analog sensors for weather station
Combi sensor with DCF77 receiver	WS 10 KSDCF	126	
Wind sensor	WS 10 W	127	
Rain sensor	WS 10 R	128	
Brightness sensor	WS 10 H	129	
Dawn sensor	WS 10 D	129	
Temperature sensor	WS 10 T	130	
Analog output, 4-gang	2204.01 REG A	131	Analog outputs
Analog output extension, 4-gang	2204.01 REG AM	135	
Time switch, 2 channel	2152 REG	136	Time switch
Time switch, 4 channel	2154 REG	138	
Time switch, 16 channel	2156 REG	142	
Time switch, accessories		145	
Switch actuator, flush mounted, 1-gang, 16 A	2131.16 UP	146	Actuators Standard switching
Switch actuator, flush mounted, 2-gang, 6 A	2132.6 UP	146	
Switch actuator, 2-gang, 16 A	2132.16 REG	150	
Switch actuator, 6-gang, 6 A	2136.6 REG	152	
Switch actuator, 4-gang, 16 A	2304.16 REG HM (short, full)	155	
Switch actuator, 8-gang, 16 A	2308.16 REG HM (short, full)	155	
Switch actuator, 4-gang, 16 A, C-load	2304.16 REG CHM (short, full)	160	
Switch actuator, 8-gang, 16 A, C-load	2308.16 REG CHM (short, full)	160	
Switch actuator, 8-gang, 16 A / Blinds actuator 4-gang	2308.16 REG HE	162	Switching/shutter
Switch actuator, 16-gang, 16 A / Blinds actuator 8 gang	2316.16 REG HE	162	

Contents

	Device	Ref.-No.	Page
Shutter/blinds	Shutter/blinds actuator flush mounted, 1-gang	2231 UP	168
	Shutter/blinds actuator, 4-gang, 6 A, 24 V DC	2224 REG H	171
	Shutter/blinds actuator, 4-gang, 230 V AC		
	2-gang, 24 V DC	2504 REG HE	174
	Shutter actuator, 4-gang, 6 A, 230 V	2204 REG HR	182
Dimming	Universal dimming actuator, 1-gang, flush mounted	3210 UP	186
	Universal dimming actuator, 1-gang	3601 REG	189
	Universal dimming actuator, 2-gang	3602 REG	192
	Universal dimming actuator, 4-gang	3704 REG HE (short, full)	195
	Control unit, 2-gang, 1 – 10 V interface	2092 REG X	198
	Light sensor for 2092 REG X	2092 LFX	200
	Control unit, 3-gang, 1 – 10 V interface	2193 REG	201
Heating	Valve drive	2176 SV	204
	Heating actuator, 6-gang	2136 REG HZ	206
Displaying/reporting	LCD info display	..2041..	208
	LCD mini panel	MT 701	210
	Colour touch panel	FP 701 CT	212
	Design frames for FP 701 CT	FP.. 781..	215
	Flush recessed box for FP 701 CT	EBG 24	216
Communication	Telecommunication interface, wall mounted	2601	217
	EIB/radio converter, 50 channels	2700 AP	219
	IR-Gateway	A 2800 IR..	221
	Bluetooth Gateway	BG.. 2041..	224
	DALI Gateway	2097 REG HE	227
	IP Central unit	IPZ 1000 REG	231
Security	Alarm central unit	EAM 4000	241
	Components for EAM 4000		244
Synoptics	Signal panel L 40	2405	246
	Operator panel TL 15	2410	246
	Blank plate	2415	247
	Panel box, flush mounted	2422 U ... 2426 U	248
	Panel box, surface mounted	2422 A ... 2426 A	248
	Electronic control module	2430 REG	249
	Power supply 5 V	2447 REG	250
Visualization	Facility-Pilot FAP Software		
	Planner version	FAP-PLANER-GB	251
	50 data-point version	FAP50-GB	251
	300 data-point version	FAP300-GB	251
	Full version	FAPVOLL-GB	251
	Client versions for network application	FAPCLIENT..GB	251
	OPC Editor	OPC-EDITOR	251
	15" Touch-PC including FAP full version	PCT 15 FAP V..	259
	Flush box for PCT 15 FAPV-GB		
	(metal version)	PCT 15 EBG	261

Device	Ref.-No.	Page	
Ribbon cable 20-poles			Accessories
– 300 mm	2450.300	262	
– 500 mm	2450.500	262	
Bus connection block	2050 RT SW	262	
Radio-controlled wall-mounted transmitter	40 FW	263	
Push-button sensor for 40 FW	.. NABS	264	
“Flat” radio-controlled wall-mounted transmitter	.. 41 F..	265	
Radio-controlled hand-held transmitter			
Standard version	48 FH	266	
Comfort version	48 KFH	266	
Mini version	42 FH	266	
Wall-fixing for 48 FH/48 KFH	WH 48	266	
Universal radio transmitter	FUS 22 UP	267	
Radio-controlled multifunction transmitter	FMS 4 UP	267	
Label tool software		268	
Blank plates		269	
Cover frames		271	

AI	= Application interface	Abbreviations
AM	= Application module	
AP	= Surface mounted devices	
BCU	= Bus coupling unit	
PB	= Push-button	
REG	= Series embodiment	
SELV	= Safety extra low voltage	
SU	= Units for data rails (series embodiment)	
TC	= Telecontrol (Telecommunication interface)	
UP	= Flush mounted devices	

System Devices

Power Supply

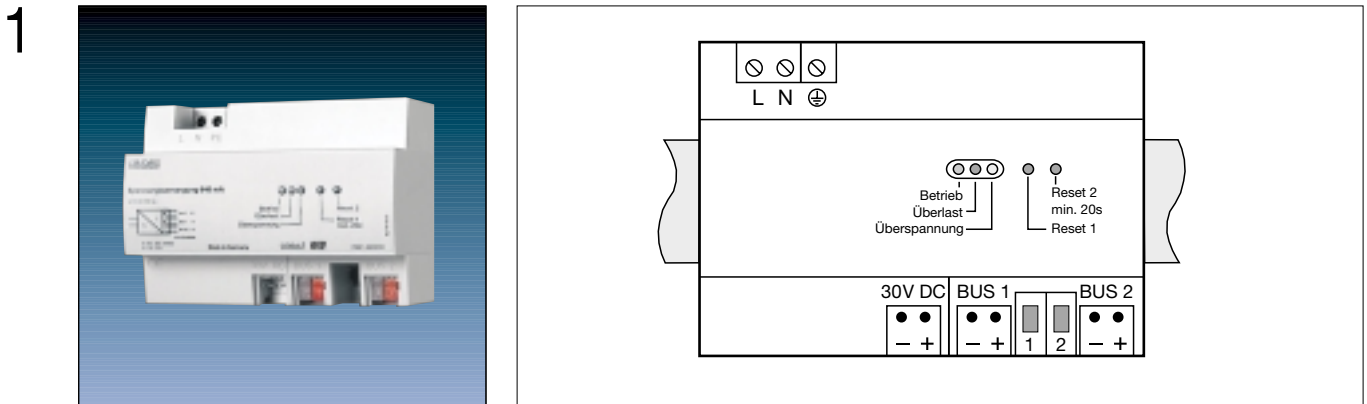

2

	Ref.-No.
KNX power supply 640 mA	2002 REG
ETS-product family:	System components
Product type:	Power supply
Series embodiment (SE)-device (7 units)	

3

The power supply 640 mA produces and controls the system power for two or three bus lines for an KNX system. The devices can be connected to two independent bus lines via the terminal BUS 1 and BUS 2, without an additional choke. Furthermore, the power supply offers a 30 V DC output to supply a further bus line (i.e. main line). For this an additional choke is required. Alternatively, that output can be used as a power supply for any further low voltage equipment. The connection of the bus by a bus terminal on the device does not require any data rail. According to the KNX regulations it is possible to connect the two outputs in parallel, when there is a minimum distance of 200 m between the bus terminals. The distribution of the load (KNX devices) is flexible on all outputs, but the rated current of 640 mA is the total limit. There are two reset switches on the device to short-circuit both bus lines separately. The operation time for a reset should be at least 20 sec.

Five LED's are indicating the different operation status:

LED-indication:	1st red LED:	short-circuit or overload
	green LED:	normal operation
	yellow LED:	over voltage, when bus voltage > 31 V DC
	2nd red LED:	reset 1 for bus line 1
	3rd red LED:	reset 2 for bus line 2

4

Technical data:

Input supplying
Voltage:161 V – 264 V AC, 50-60 Hz
Operation with 2 lines of 110 V mains possible !
176 V – 270 V DC (for emergency power supply)

Power consumption:

< 5 W under normal operation

Connection:

screw terminals 0.2 – 4 qmm single wire
 2 x 0.2 – 2.5 qmm single wire

Output

Number

3

Rated voltage:

Bus terminal BUS 1

Connection:

28 V – 31 V DC, SELV

KNX connection block

Bus terminal BUS 2

Rated voltage:

28 V – 31 V DC, SELV

Connection:

KNX connection block

Bus terminal 30 V DC

Rated voltage:

28 V – 31 V DC, SELV

Connection:

KNX connection block

Rated current:

max. 640 mA (BUS 1 + BUS 2 + 30 V DC)

Protection:

short-circuit protection

Operation temp.:

IP 20

Storage temp.:

–5°C ... +45°C

Mounting:

–25°C ... +55°C / +70°C

on DIN rail 35 x 7.5

System Devices

Power Supply

1

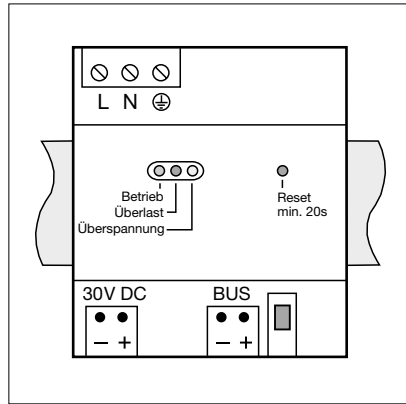

2

	Ref.-No.
KNX power supply 320 mA	2005 REG
ETS-product family:	System components
Product type:	Power supply
Series embodiment (SE)-device (4 units)	

3

The power supply 320 mA produces and controls the system power for the KNX. The devices can be connected to a bus line via the terminal BUS, without an additional choke.

Furthermore, the power supply offers a 30 V DC output to supply a further bus line (i.e. main line). For this an additional choke is required.

Alternatively, that output can be used as a power supply for any further low voltage equipment.

The connection of the bus by a bus terminal on the device does not require any data rail.

The distribution of the load (KNX devices) is flexible on both outputs, but the rated current of 320 mA is the total limit.

There is one reset switch on the device to short-circuit the bus line. The operation time for a reset should be at least 20 sec.

Four LED's are indicating the different operation status:

LED-indication: 1st red LED: short-circuit or overload

green LED: normal operation

yellow LED: over voltage, when bus voltage > 31 V DC

2nd red LED: reset 1 for bus line 1

4

Technical data:

Input supplying

Voltage:

161 V – 264 V AC, 50-60 Hz

Operation with 2 lines of 110 V mains possible !

176 V – 270 V DC (for emergency power supply)

Power consumption:

< 5 W under normal operation

Connection:

screw terminals

0.2 – 4 qmm single wire

2 x 0.2 – 2.5 qmm single wire

Output

Number

2

Bus terminal BUS 1

Rated voltage:

28 V – 31 V DC, SELV

Connection:

KNX connection block

Bus terminal 30 V DC

Rated voltage:

28 V – 31 V DC, SELV

Connection:

KNX connection block

Rated current:

max. 320 mA (BUS + 30 V DC)

short-circuit protection

Protection:

IP 20

Operation temp.:

-5°C ... +45°C

Storage temp.:

-25°C ... +55°C / +70°C

Mounting:

on DIN rail 35 x 7.5

System Devices

Power Supply

1



2

	Ref.-No.
KNX uninterruptible power supply 640 mA	USV 640 MA
ETS-product family:	System component
Product type:	Power supply
Series embodiment (SE)-device (8 units)	

3

The uninterruptible KNX power supply generates and monitors the system voltage. The integrated choke decouples the power supply and the bus-line. In order to buffer the KNX system-voltage during power failure, up to two 12 V lead-gel batteries can be connected. The batteries are charged by the power supply. The charging voltage is controlled temperature depending by the temperature sensor. In case of a power failure the uninterruptible power supply will be supplied by the batteries. The temperature sensor must be connected for a proper charging of the batteries. Via a floating change-over contact a failure of the uninterruptible power supply will be reported and stored. The following failures cause a switch-over: power failure, battery failure, overvoltage, over load and short circuit. The max. charging time of the lead-gel battery amounts to 28 hours (1 x 12 Ah-battery) respectively 56 hours (2 x 12 Ah-batteries in parallel).

4

Technical data:

Supplying	
Voltage:	230 V AC, +10/-15 %, 45 ... 65 Hz
Power consumption:	< 60 VA
Power loss:	< 10 W
KNX Output	
Number	1 line with integrated choke
Output voltage:	30 V DC, +1/-2 V, SELV
Nominal current:	640 mA, permanent short circuit proof
Permanent short-circuit current:	< 1.5 A
Mains failure bridgeover time:	200 ms (without connected battery)
Battery type:	lead-gel battery
Number:	max. 2 in parallel
Rated voltage:	recommended 1 Ah, 7 Ah, 12 Ah, 17 Ah
Rated battery charge current:	650 mA, at battery capacity > 5 Ah 150 mA, at battery capacity < 5 Ah
Temperature control:	temperature-controlled charging voltage via temperature sensor
Floating contact	
Rated voltage:	230 V AC resp. 12/24 V AC/DC
Max. switching current:	6 A AC resp. 4 A DC
Min. switching current:	100 mA (at U < 30 V AC/DC)
Connections	
Change-over contact:	3 screw terminals each
Battery and temperatur sensor:	2 screw terminals each
Screw terminals:	0.2 ... 4 mm ²
Operation temperature:	-5°C ... +45°C

System Devices

Lead-gel battery

1



2

	Ref.-No.
Lead-gel battery	BGA 12 AH
12 V DC, 12 AH	

3

In combination with the uninterrupted KNX power supply, the lead-gel battery serves for the buffering of the system voltage. Max. two lead-gel batteries can be connected in parallel to the power supply. In that case two equal lead-gel batteries must be used. For the connection of a single battery the 4-wire cable-set must be used, for the connection of two batteries the 4-wire cable-set must be used for the first one, the second one must be connected with the 2-wire-cable-set. The durability of lead-gel batteries adds up to 5 years.

4

Technical data:

Supplying	
Voltage:	12 V DC
Capacity:	12 AH
Dimensions:	151 x 94 x 98 mm (w x h x d)
Weight:	4,2 kg
Operation temperature:	-20°C ... +50°C

1



KSB 4

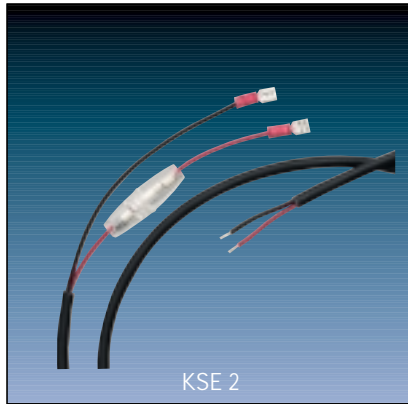

KSE 2

2

	Ref.-No.
Cable-set	
Basis	KSB 4
Extension	KSE 2

3

For the connection of the uninterrupted KNX power supply and the lead-gel battery the 4-wire cable-set (for one battery) respectively the 4-wire and the 2-wire set for two batteries must be used.
The 4-wire cable-set has an integrated fuse and a temperature sensor, the 2-wire cable-set has only an integrated fuse.

4

Technical data for:	KSB 4	KSE 2
Cable:	4-wire cable	2-wire cable
Diameter:	0,75 mm ²	0,75 mm ²
Length:	2 m	2 m
Colours		
Battery connection:	red (12 V battery) black (GND battery)	red (12 V battery) black (GND battery)
Temperature sensor:	white (12 V temp. sensor) yellow (GND temp. sensor)	
Connection		
Battery:	for the connection to the uninterrupted power supply: wire end sleeve for connection to the battery: cable lug	for the connection to the uninterrupted power supply: wire end sleeve for connection to the battery: cable lug
Temperature sensor:	wire end sleeve	
Fuse:	5 x 20 mm, T6,3 H 250 V	5 x 20 mm, T6,3 H 250 V

System Devices

Line coupler

1

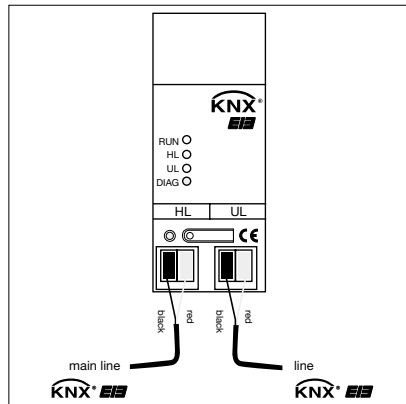

2

	Ref.-No.
KNX line coupler	2142 REG
ETS-product family:	System component
Product type:	Line coupler
Series embodiment (SE)-device (2 units)	

3

Function: The coupler connects two KNX lines together and guarantees electrical isolation between these lines. The exact function of the device is defined by the address and the selected application.

Line coupler: Connection of a line and a main line with or without a filter function. The coupler is physically assigned to the secondary line (here: line).

Backbone coupler: Connection of a main line and a backbone line with or without a filter function. The coupler is physically assigned to the secondary line (here: main line).

Amplifier: Preparation and repetition of telegrams on a line, no filter function. Subdivision of a line into max. 4 independent line segments = max. 3 line repeaters per line connected in parallel. A separate power supply including a choke is required for each line segment.

4

Technical data:

Power supply:	21 – 32 V DC via the primary line
Power consumption	
Primary line:	approx. 6 mA
Secondary line:	approx. 8 mA
Connection:	KNX connecting terminal for primary and secondary line
Ambient temperature:	-5°C ... +45°C
Storage temperature:	-25°C ... +70°C
Protection:	IP 20 in accordance with EN 60529
Protection class:	III in accordance with EN 61140

Note:

- The filter tables are stored in a non-volatile memory (flash). This means that the stored addresses are not lost after a bus voltage failure and that no internal backup battery is required.

5 Commissioning

During commissioning of a project with area/line couplers, the following sequence of operations should be observed:

1. Project design of the KNX installation (physical address, group addresses, parameters).
2. At first, the physical addresses of the couplers and their application programs must be programmed and then the physical addresses of the other KNX devices. Thereafter, the applications can be loaded into the KNX devices (actuators, sensors, etc.). For testing of a KNX installation, especially in the modification phase before project design completion, it is recommended to set the parameters "Group telegrams main line → line" and "Group telegrams line → main line" at first to "Transmit all". This means that any programmed filter tables are not yet taken into account in the testing phase.
3. The filter tables can then be generated on completion of project design and commissioning (in the ETS 2 under menu item: Commissioning/ Project design – generating filter tables / ETS 3 generates them automatically).
4. Finally, the filter tables should be programmed into the couplers. The filter tables are loaded automatically when the complete application is downloaded or also during partial programming of the "group addresses".

Especially with smaller projects, the filter tables can be generated and programmed already under item 2. (together with the programming of the physical addresses for the couplers). In larger projects, it is absolutely important to program filter tables in order to avoid unnecessarily high bus loads and thus communication problems.

The area/line coupler can be programmed from the higher-order but also from the subordinate line.

Topology

The area/line coupler transmits telegrams between a subordinate line and a higher-order line (line coupler: line – main line, area coupler: mainline – backbone bus). In the project design phase, the function of the device is defined by the physical address as follows:

Area coupler (AC)	A.0.0	(1 ≤ A ≤ 15)
Line coupler (LC)	A.L.0	(1 ≤ A ≤ 15, 1 ≤ L ≤ 15)

Each line has a power supply (PS) of its own and is electrically isolated from the bus. With line couplers, up to 15 lines can be grouped into an area. With area couplers (AC), up to 15 areas can be interconnected.

From a logical point of view, area/line couplers are assigned to the pertaining subordinate line. The hierarchy of line and area couplers in a KNX system is thus as follows:

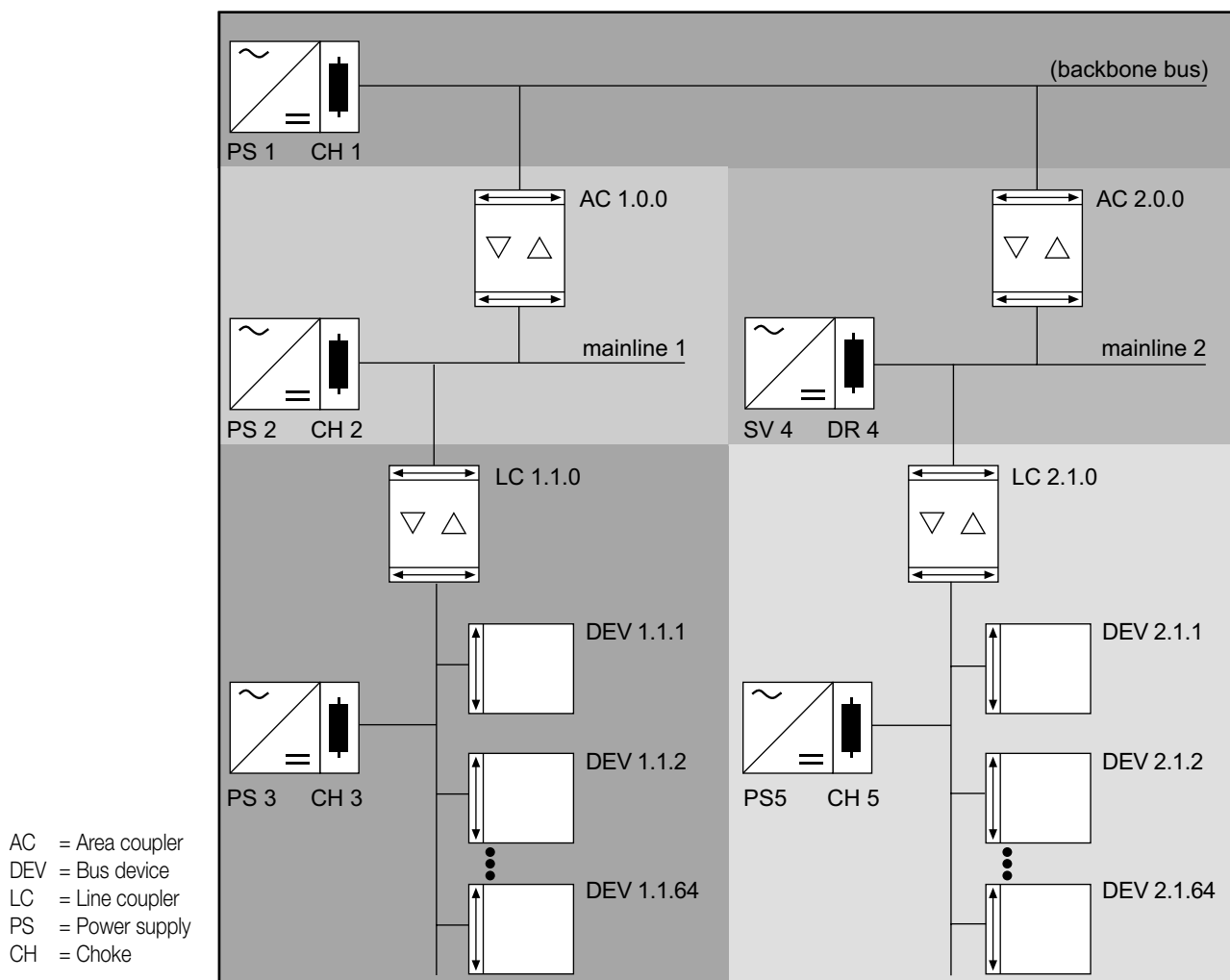

The coupler logics is supplied with electric power from the higher-order line.

System Devices

Bus coupling unit (BCU)

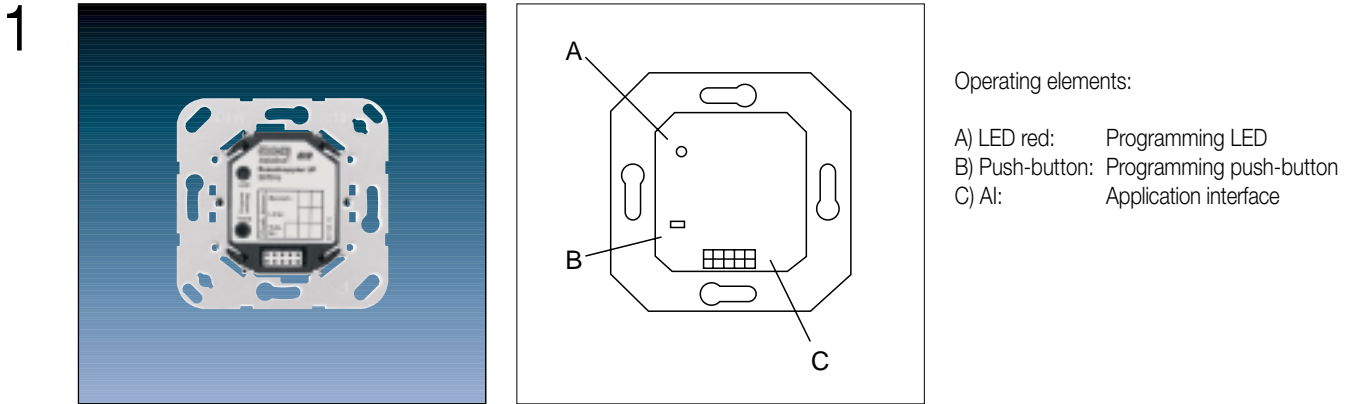

2

	Ref.-No.
KNX bus coupling unit with supporting frame for flush mounting	2070 U
ETS-product family:	System components
Product type:	Bus coupling unit
suitable for wall boxes with Ø 60 mm	

3

The bus coupling unit (BCU) enables application modules (AM) to be connected to the KNX. The AM could be a push-button, sensor or display fixed with the BCU. The telegrams received via the KNX are processed by the BCU and passed on to the AM. In the opposite direction, signals coming from the AM are converted into telegrams and transmitted to the bus. With the help of the programming push-button and the programming LED the physical address is saved in the BCU.

4

Technical data:	
Supply voltage:	24 V DC (+6 V / -4 V)
Power consumption:	max. 100 mW, max. 150 mW with application module
Connection:	KNX connection block
Notes to the AI	
Output voltage:	5 V DC + 0,4 V; 24 V DC (+6 V / -4 V)
Output power:	max. 50 mW
Protection:	IP 20
Operation temperature:	-5°C ... +45°C
Storage temperature:	-40°C ... +55°C
Mounting:	fitted in wall box 60 mm
Dimensions:	Depth of recess: 32 mm

1



2

	Ref.-No.
KNX logic module	2145 REGX
ETS-product family:	Controller
Product type:	Controller
Series embodiment (SE)-device (2 units)	

3

The logic module is a DIN rail mounted device. With the logic controller and its sophisticated application software complex processes in building automation can be realized.
The graphic surface of the software offers different logic links and time elements, combined together by "drag and drop".

4

Technical data:

Supply voltage:	24 V DC (+6 V / -4 V)
Power consumption:	max. 150 mW
Connection:	KNX connection terminal
Protection:	IP 20
Operation temperatur:	-5°C to +45°C
Mounting:	on DIN rail 35 x 7,5
Dimensions:	90 x 36 x 64 mm (H x W x D)

5

Description of application Logic link, time 200 EA/1

- Smart parameterization of logic links due to the graphic surface and the drag & drop function.
- Similar to SPS programming referring to DIN 40900.
- The application software starts up after selecting parameter button.
- 200 objects for inputs or outputs, 250 assignments.
- 50 logic links, 50 tri-state gates, 30 time elements and timer functions.
- Types of logic links: AND, OR, EXOR

System Devices

Serial data interface

1

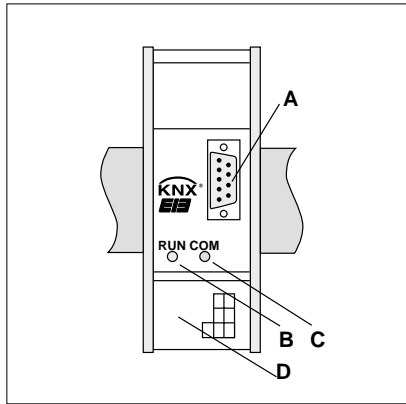

Operating elements:

- A) SUB-D connector (RS-232 female)
- B) green LED "RUN": ready for operation
- C) yellow LED "COM": data communication with connected PC in progress
- D) hinged lid: access to bus connection, programming push-button and LED

2

	Ref.-No.
KNX serial data interface	2131 REG
ETS-product family:	Communication
Product type:	Serial
Series embodiment (SE)-device (2 units)	

3

The data interface permits connection to a PC via the serial RS-232 interface for addressing, programming and diagnosis of KNX components. The PC is connected to the data interface by means of a 9-pole Sub-D connector.

For operation of the data interface it is not required to load software into the device with the ETS! The operating software of the bus coupler is automatically configured by the hardware as serial asynchronous interface.

4

Technical data:

KNX supply voltage:	21 – 32 V DC SELV
Current consumption:	approx. 4.5 mA
Connection:	KNX connecting terminal
PC supply	
Voltage:	± 5 V ... ± 15 SELV
Current consumption:	approx. 10 mA
Rated insulation voltage:	2.5 kV
Response to bus voltage failure:	communication stopped
Response on return of bus voltage:	communication resumed
RS-232 transmission rate:	max. 9.6 kBaud
PC connection:	9-pole SUB-D connector
Max. line length:	15 m
Protection:	IP 20
Mark of approval:	KNX
Ambient temperature:	-5°C ... +45°C
Storage temperature:	-25°C ... +70°C (storage above +45°C reduces the lifetime)
Mounting position:	any
Fastening:	Snap-fastening on DIN rail

1

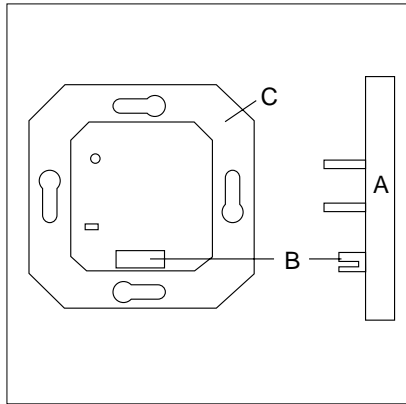

A: Application module (AM)
 B: Application interface (AI)
 C: Bus coupling unit (BCU)

2

	Ref.-No.
Data-interface	
ETS-product family:	Communication
Product type:	Serial
ivory	2130
white	CD 2130 WW
blue	CD 2130 BL
brown	CD 2130 BR
grey	CD 2130 GR
light grey	CD 2130 LG
red	CD 2130 RT
black	CD 2130 SW

On special request also available in stainless steel or aluminium (lacquered).

3

The integrated 9pole SUB D plug enables a PC to be connected to the KNX system and can be plugged onto any flush mounted BCU. This serial interface is used for addressing, parameterizing and for diagnosis of bus devices.

4

Technical data:

Input	
Number:	1
Connection:	9-pole SUB D plug
Protection:	IP 20
Insulation voltage:	referring to VDE 0829 part 230
Operation temperature:	-5°C ... +45°C
Mounting:	plugged onto a flush mounted BCU

System Devices

USB data-interface

1



2

	Ref.-No.
KNX USB data-interface	2130 USB REG
ETS-product family:	Communication
for DIN rail mounting	
Series embodiment (SE)-device (2 unit)	

3

The USB data interface enables the coupling of a PC for the addressing, programming and diagnoses of KNX components. The power is fully supplied by the connected PC via the USB interface. This means that the USB data interface is no longer connected for the KNX if the USB cable is not plugged in. The device is only programmed locally with a physical address via the connected PC and therefore does not have a programming button or programming LED. The firmware of the USB data interface can be updated via a PC and is therefore safeguarded for future standards.

For 2130 USB and 2130 USB REG

Note:

The USB data interface is supported by ETS 3 software from version "a" upwards and by the PC operating systems Windows 98, 98 SE, ME, 2000 and XP.

Connection:

The connection to the KNX is carried out with the aid of the bus connecting terminal. The USB connection is carried out with a certified USB cable (1 x B plug required) with a max. length of 5 m.

4

Technical data:

Power supply:	via USB port of the PC
Connection KNX:	KNX connecting terminal
USB port:	USB socket, type B
Transmission protocol:	compatible with USB 1.1/2.0
Length of USB cable:	max. 5 m
Ambient temperature:	-5°C ... +45°C
Storage temperature:	-25°C ... +70°C
Protection:	IP 20
Protection class:	II

System Devices

USB data-interface

1

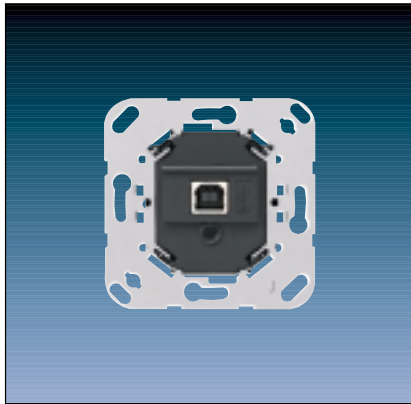

2

	Ref.-No.
KNX USB data-interface	2130 USB
ETS-product family:	Communication

3

The USB data interface enables the coupling of a PC for the addressing, programming and diagnoses of KNX components. The power is fully supplied by the connected PC via the USB interface. This means that the USB data interface is no longer connected for the KNX if the USB cable

programming button or programming LED. The firmware of the USB data interface can be updated via a PC and is therefore safeguarded for future standards.

Suitable covers:

AS 500 / A 500 / A plus

ivory	A 569 PLT
white	A 569 PLT WW
aluminium	A 569 PLT AL

CD 500 / CD plus

ivory	569 T	with inscription plate
white	CD 569 T WW	569 TNA
blue	CD 569 T BL	CD 569 TNA WW
brown	CD 569 T BR	CD 569 TNA BL
grey	CD 569 T GR	CD 569 TNA BR
light grey	CD 569 T LG	CD 569 TNA GR
red	CD 569 T RT	CD 569 TNA LG
black	CD 569 T SW	CD 569 TNA RT
gold-bronze	CD 569 T GB	CD 569 TNA SW
platinum	CD 569 T PT	CD 569 TNA GB
		CD 569 TNA PT

LS 990 / LS plus / Aluminium / Stainless Steel / Anthracite / Chrom / Gold

ivory	LS 969 T
white	LS 969 T WW
light grey	LS 969 T LG
Metal versions	
aluminium	AL 2969 T
stainless Steel	ES 2969 T
anthracite	
(lacquered aluminium)	AL 2969 T AN
chrom	GCR 2969 T
gold (coloured)	GO 2969 T

IP Router

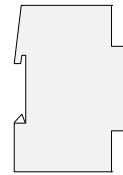

System

Product name:	IP router
Design:	REG (rail-mounted device)
Article-no.:	IPR 100 REG
ETS search path:	System devices / IP router / IP router
Issue:	03.04.2007
Functional description:	
<p>The IP router interconnects KNX / EIB lines via data networks using the Internet Protocol (IP). The IP router implements the EIBnet/IP standard so that it cannot only be used for routing KNX / EIB telegrams between lines via an IP network, but also for access to the bus from a PC or from other DP devices (visualization displays and applications). The IP router can thus also be used as an IP data interface for the ETS 3.0 after version "c". By using a LAN modem, an EIB installation can be remotely accessed even if there is no direct local data network connection between a PC and an IP router.</p> <p>The use of the existing data network for communication between bus lines makes sense especially in non-residential buildings. The advantages are:</p> <ul style="list-style-type: none"> - fast communication between KNX / EIB lines, - extending a KNX / EIB system by means of LAN and WAN beyond a building, - direct routing of KNX / EIB data to each network user (not in bus monitor mode) - KNX / EIB remote configuration from each network access point. <p>In its capacity as an area/line coupler, the IP router interconnects two KNX / EIB lines to form a logical functional area ensuring at the same time the electrical separation between these lines. Each bus line of a KNX / EIB installation is thus electrically independent of other bus lines.</p> <p>The exact function of the device is determined by the physical address.</p> <p>For operation, the IP router needs an external power supply of 24 V AC/DC. The IP router is powered via this operating voltage terminal connector. This feature enables the IP router to transmit a bus voltage failure message via the data network.</p>	
Illustration:	<p>Dimensions:</p> <p>Width: 36 mm; 2 modules Height: 90 mm Depth: 60 mm</p> <p>Controls / terminals:</p> <p>A connecting terminals for KNX / EIB line B connecting terminals for external power supply 24 V AC/DC C connecting terminals for Ethernet / LAN (RJ45 socket) D LED "Run" (green): ready for operation signal (external power supply active) E LED "Line"(yellow): active during reception of data at KNX / EIB bus connection F LED "LK"(green): signals active connection with the IP network (Ethernet Link) G LED "RX"(yellow): active during reception of valid IP telegrams (Ethernet Receive) H LED "TX"(red): active during transmission of IP telegrams (Ethernet Transmit) I Programming LED (red) J Programming button</p>

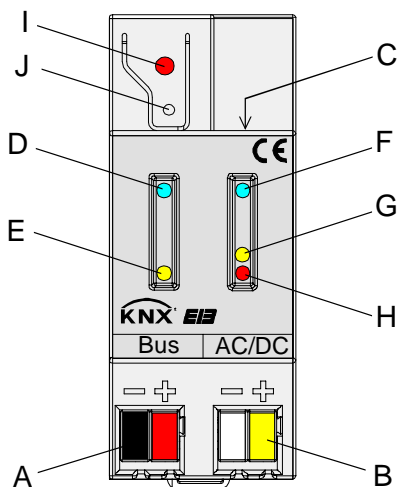

Technical data	
Type of protection	IP 20 (acc. to EN 60529)
Safety class:	III (acc. to IEC 61140)
Mark of approval:	KNX / EIB
Ambient temperature:	- 5 °C to + 45 °C
Storage temperature	- 25 °C ... + 70 °C (storage above + 45 °C reduces the lifetime)
Type of fastening:	snap-fastening on DIN rail (no data rail required)
Bus connection:	
Voltage:	21 – 30 V DC SELV
Power consumption:	typically 290 mW at 29 V DC
Current	typically 10 mA at 29 V DC
Connection:	with KNX / EIB connecting / branching terminal
External power supply:	
Voltage:	24 V (12...30 V) AC/DC SELV
Power consumption:	max. 800 mW at 30 V DC
Current	max. 27 mA at 30 V DC
Connection:	with KNX / EIB connecting / branching terminal (preferably yellow/white)
Recommended power supplies:	suitable power supplies 24 V (12...30 V) AC/DC SELV e.g. doorbell transformer or... WSSV 10 power supply 24V AC Note: Do <u>not</u> use a KNX/EIB power supply unit as external supply if a bus line is connected to this supply!
Network:	
Connection:	Ethernet 10BaseT (10 Mbit/s)
Supported protocols:	ARP, ICMP, IGMP, UDP/IP, DHCP KNXnet/IP in acc. with KNX system specification: Core, Routing, Tunneling, Device Management
Response to bus voltage failure / recovery:	A voltage failure on the bus line is internally stored and – depending on parameterization – signalled via the KNXnet/IP. The message is cancelled via KNXnet/IP as soon as bus voltage recovery is detected.
Wiring diagram / Terminals:	<p>The diagram shows the internal wiring of the device. At the top, an Ethernet/LAN cable is connected to a terminal block. Below this, there are two vertical terminal blocks. The left one is labeled 'Bus' and has two terminals with blue and yellow indicators. The right one is labeled 'AC/DC' and has two terminals with red and yellow indicators. At the bottom, there are two power terminals labeled 'black' and 'red', connected to a 24 V AC/DC power source. A green line labeled 'bus line' is connected to the 'Bus' terminals. The KNX EIB logo is visible at the bottom left of the diagram.</p>

Wiring example:

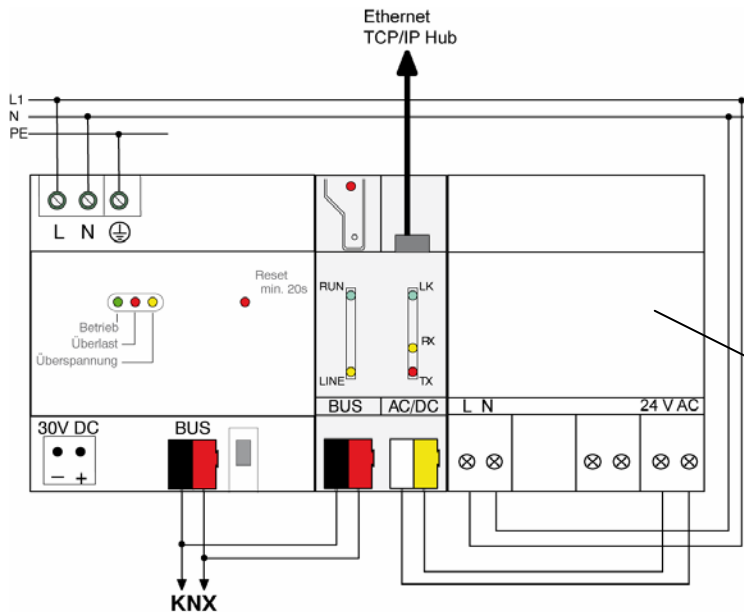

separate power supply
24 V (12...30 V) AC/DC
e.g. WSSV 10

Inadmissible device connection:

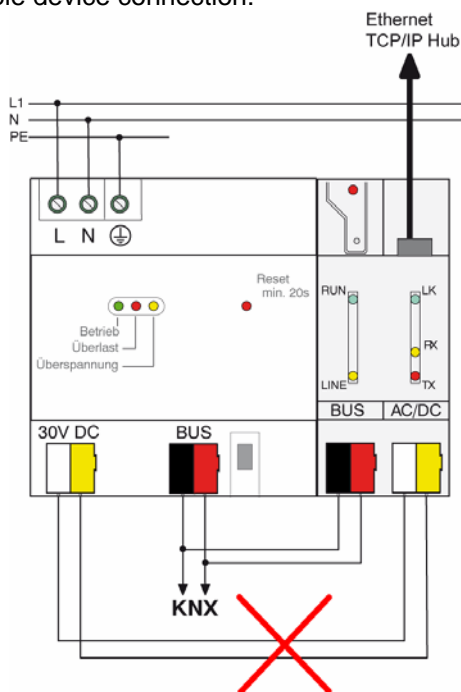

Do not use a KNX/EIB power supply unit
as external supply if a bus line is
connected to this supply!



CAUTION!

The router connects the external extra-low supply voltage with the potential of the LAN. The insulation from ground potential is no longer ensured (incompatible with SELV specifications!) when the LAN shield is grounded.

It is recommended to use the external power supply exclusively for the IP router and not to connect any other devices to the supply.

Hardware information

- The filter tables are stored in a non-volatile memory (flash). This means that the stored addresses are not lost after a system voltage failure. And internal backup battery is not needed.
- Depending on application, access requirements, data security and data volume it may be advisable to install independent network paths for individual services using the IP network.

Software information

ETS search path:

System devices / IP router / IP router

ETS symbol:

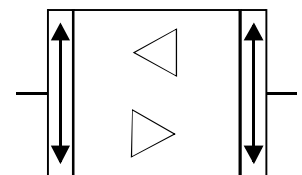

PEI Type	00 _{Hex}	0 Dec	No adapter used
-----------------	-------------------	-------	-----------------

Applications:

No.	Short description:	Name:	Version:
1	IP router	IP router 901001	0.1

Application:	1. IP router 901001		
Executable from mask version:	Coupler (\$91A)		
Number of addresses (max):	0	dynamic table handling	Yes <input type="checkbox"/> No <input checked="" type="checkbox"/>
Number of assignments (max):	0	maximum length of table	0
Communication objects:	0		

Object	Function	Name	Type	Flag
-	-	-	-	-

Object description

No objects

Scope of functions

- Simple connection to higher-level systems via the Internet Protocol (IP)
- Direct access to the KNX / EIB installation from any access point in the IP network (KNXnet/IP Tunneling – no bus monitor mode)
- Fast communication between KNX / EIB lines, areas and systems (EIBnet/IP Routing)
- Communication between buildings and facilities (networking of facilities)
- Filtering and routing of telegrams depending on...
 - physical address
 - group address
- Simple configuration with standard ETS 2 / 3
- Transmission of KNX/EIB system failure message to applications via KNXnet/IP
- Easy connection to visualization systems and Facility Management systems (see: Supported Software)

Functional description

Router working as an area or line coupler

General

In its capacity as an area/line coupler, the IP router interconnects two KNX / EIB lines to form a logical function area ensuring at the same the electrical separation between these lines. Each bus line of a KNX / EIB installation can thus be operated electrically independently from other bus lines.

A coupler either transmits telegrams using addressing via physical addresses and broadcast addressing (e.g. during start-up) or group telegrams (e.g. communication via group addresses during regular operation of a KNX / EIB-Installation).

For transmitting physically addressed telegrams, it is important that the coupler knows its own physical address, i.e. that its assignment to a line is fixed. The coupler compares the destination address of a received telegram with its own line address. Depending on parameterization, the coupler transmits telegrams, when the destination address corresponds to its line, blocks all physically addressed telegrams or transmits all telegrams, e.g. for testing purposes.

With respect to group communication, the coupler's behaviour can be parameterized depending on the transmitting direction. This way, the coupler either routes or blocks all group telegrams. During regular operation of an installation and especially in order to reduce bus loading, a filter table can be loaded into the coupler. In this case, the coupler only routes those group telegrams whose group address is included in the filter table. This principle is valid with the exception of main groups "14" and "15". Addresses belonging to these main groups can no longer be included in the filter table due to its limited overall size. These addresses can be separately blocked by a parameter or transmitted. The filter table is generated by the ETS (automatically with ETS3) and programmed into the coupler by means of a download.

i In conjunction with the IP router, the driver for bus communication of the ETS 3 does not support the "Diagnosis bus monitor" function and no local download of the application program.

Topology

In its capacity as an area / line coupler, the IP router transmits telegrams between a subordinate line and the IP network. The exact function of the device is determined by the physical address as follows:

Area (backbone) coupler A.0.0 ($1 \leq A \leq 15$)
 Line coupler A.L.0 ($1 \leq A \leq 15, 1 \leq L \leq 15$)

The IP router can, on principle, be used as a line coupler or as an area coupler (cf. Fig. 1).

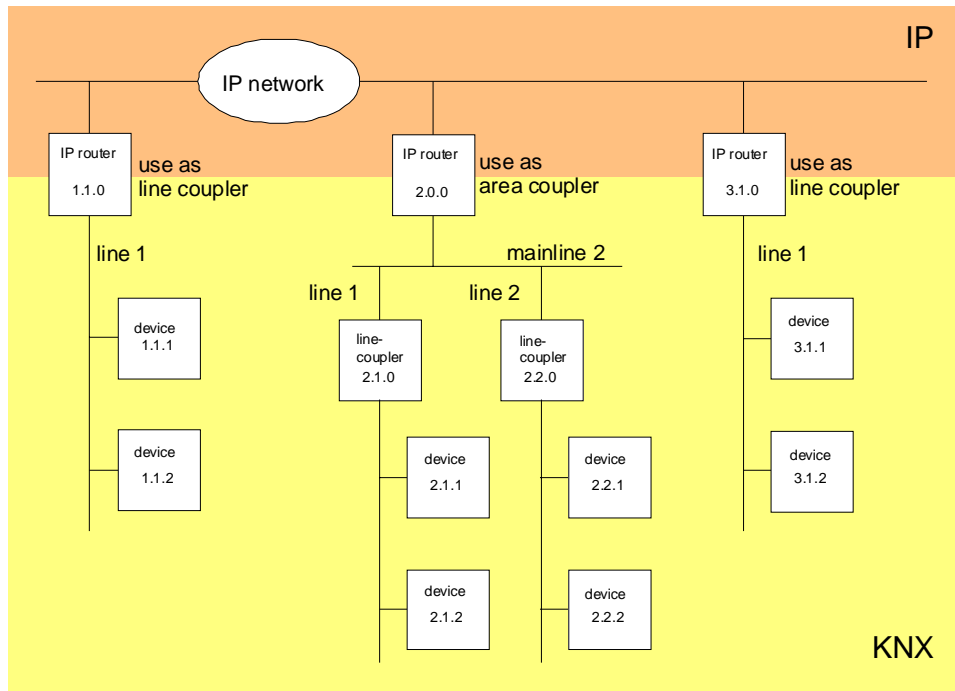

Fig. 1: IP router as area or line coupler

If the IP router is used as an area coupler with the physical address $x.0.0$ ($x = 1 \dots 15$), then no other IP router with line coupler address $x.y.0$ ($y=1 \dots 15$ – same area address) must be used topologically "below" this IP router (cf. Fig. 2).

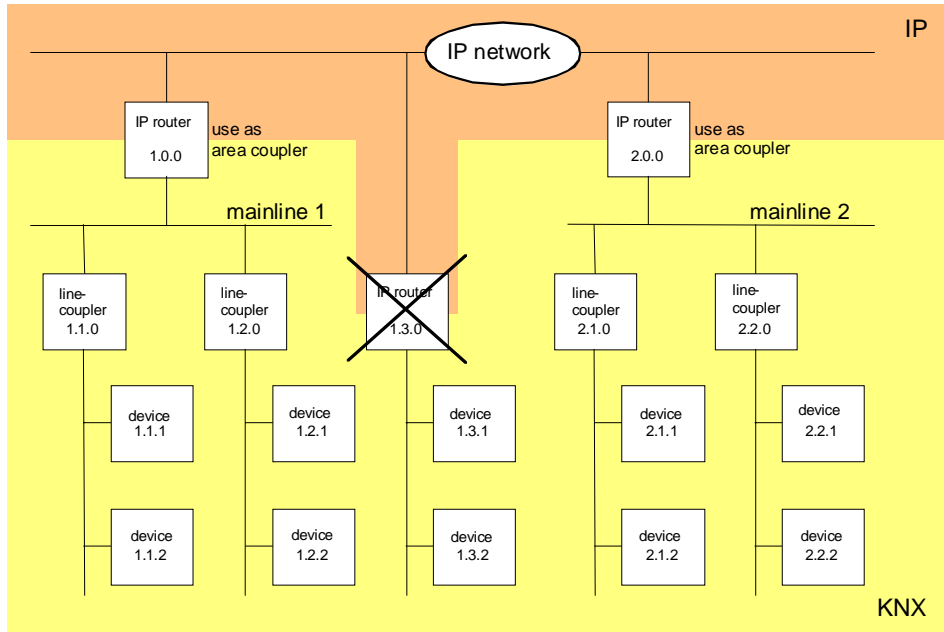

Fig. 2: IP router as area coupler

If an IP router is used as a line coupler with the physical address $x.y.0$ ($x = 1 \dots 15$, $y = 1 \dots 15$), then no other IP router with the same area coupler address $x.0.0$ must be used 'higher' in the system (cf. Fig. 3).

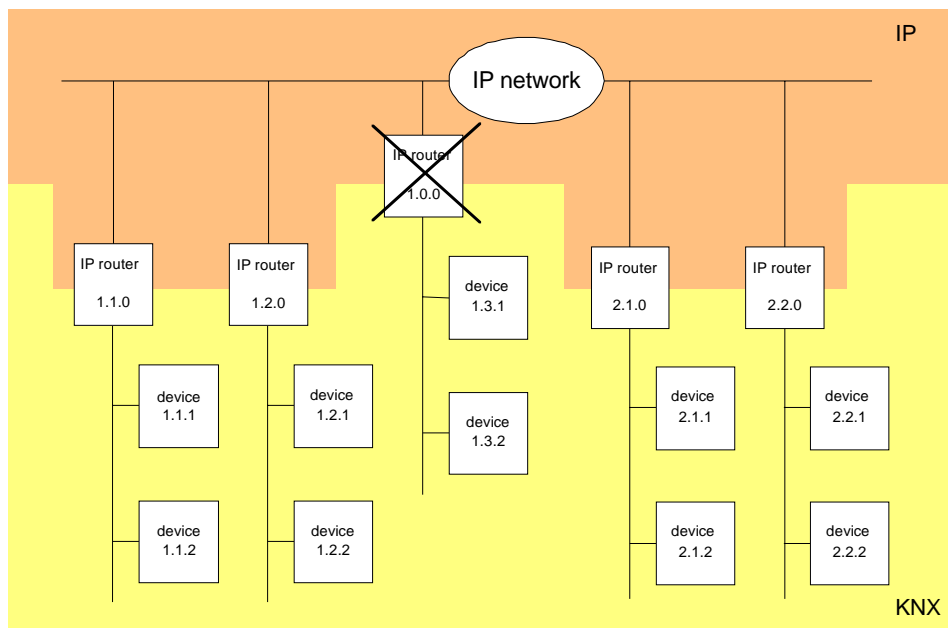

Fig. 3: IP router as line coupler

Note:

The perfect functioning of the IP router as an area or a line coupler (KNXnet/IP Routing) depends on network components supporting IP multicasting. Network / LAN routers in particular must permit a setting or be set in such a way that IP multicasting datagrams will be forwarded. For KNXnet/IP Routing, the IP multicast address reserved for this purpose is address 224.0.23.12.

Function as IP data interface

A direct connection between a networked PC or other DP terminal devices (e.g. visualization displays and applications) in the network and the KNX / EIB can be established via an IP data network and the IP router. In that case, the bus can be accessed from any point in the IP data network.

The ETS3 (from version 3.0c onwards) permits configuring KNX/EIB installations via the existing IP data network and uses the IP router like any other conventional serial RS232 or USB data interface for communication with the bus. This includes also downloading of bus devices or the function of the group bus monitor (no support of bus monitor mode).

For stable communication via KNXnet/IP Tunneling, a second physical address (similar to the local physical address with an RS232 or a USB link) must be specified. From a topological point of view (physical address of the device in the project), the IP router is projected into the KNX/EIB installation like a coupler.

To configure the communication interface, the following steps are required:

1. Start the ETS3 and open the Options menu with the communication properties (Extras → Options → Communication – cf. Fig. 4).

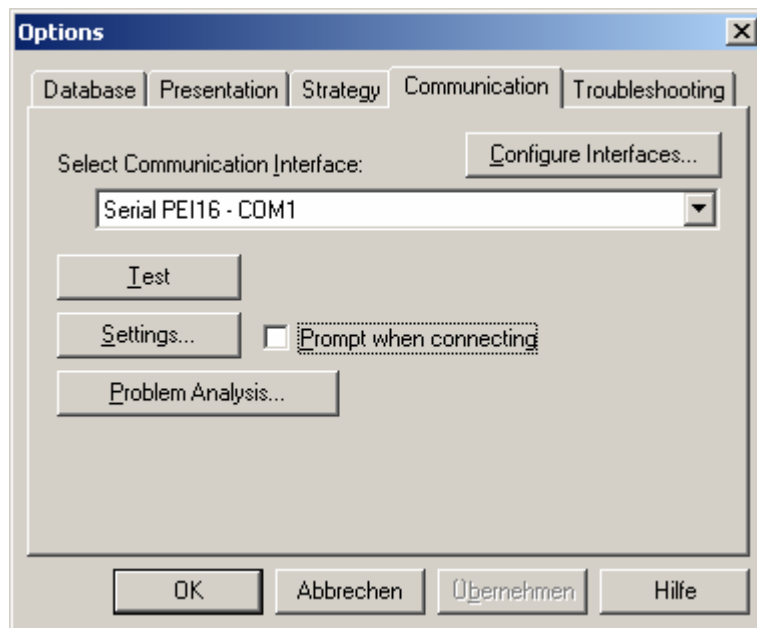

Fig. 4: Options dialog for communication properties of the ETS3

2. Select the "Configure interfaces" button. The "ETS Connection Manager" is opened (cf. Fig. 5).

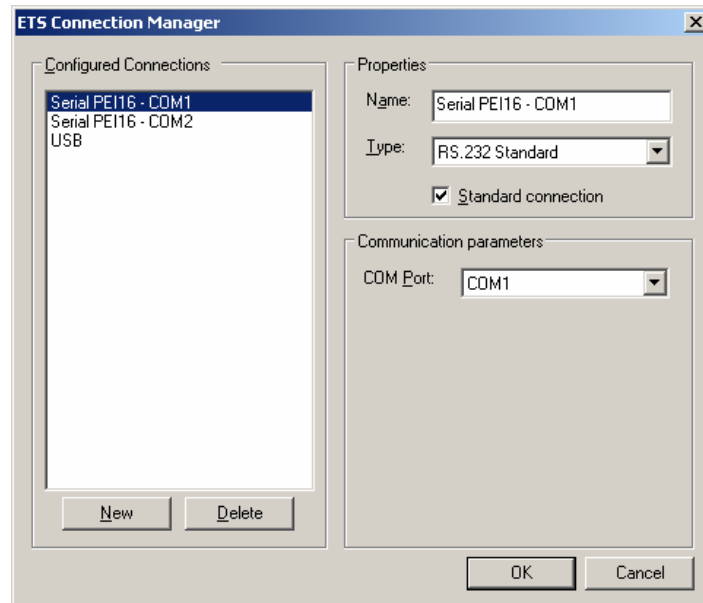

Fig. 5: ETS Connection Manager

3. Create a new connection. To do so, press the "New" button. Select a unique name for the new connection. Under "Type" select "Eibnet/IP" (cf. Fig. 6). Thereafter, the ETS3 searches the IP data network automatically for available communication devices.

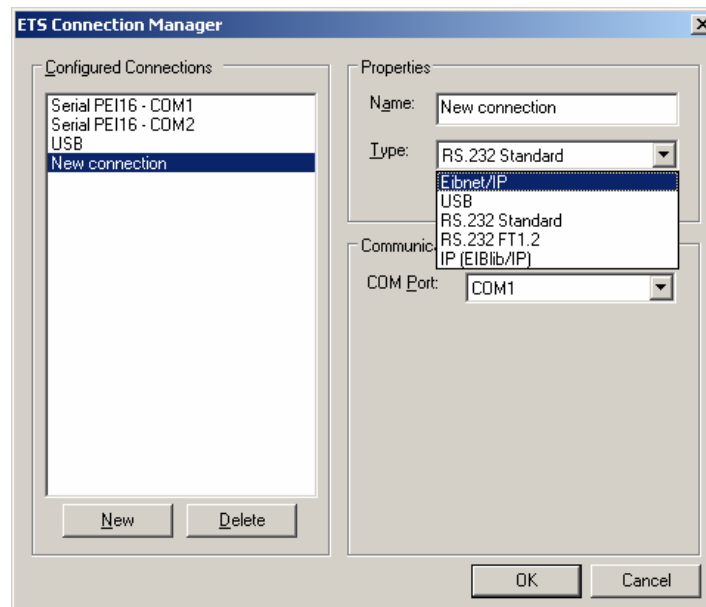

Fig. 6: Creating the new connection as EIBnet/IP connection

4. The "Eibnet/IP Device" list contains all IP routers found in the IP network (cf. Fig. 7). The name assigned in the ETS (default is "IP router") and the IP address of the IP router are indicated. The letter (P) behind these data signals that a programming mode is activated. By this means, it is possible to identify individual devices even in systems with several routers. The IP router which is to work in the configured connection as a "data interface" must be selected in the device list.

By clicking on the "Rescan" button, the ETS 3 starts a new scanning cycle to search for IP routers in the IP network.

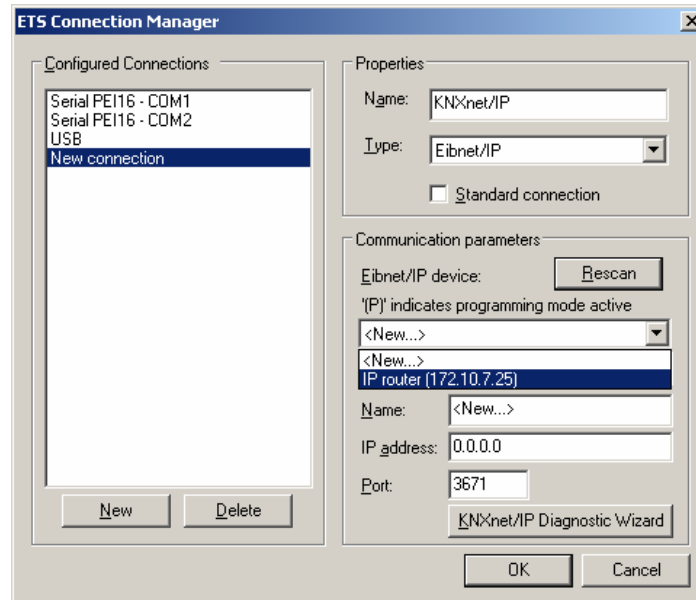

Fig. 7: List of devices in communication parameters with all IP routers found

5. Thereafter, the configuration of the new connection can be terminated by clicking on the "OK" button. The communication parameters (cf. Fig. 8) should remain unchanged.

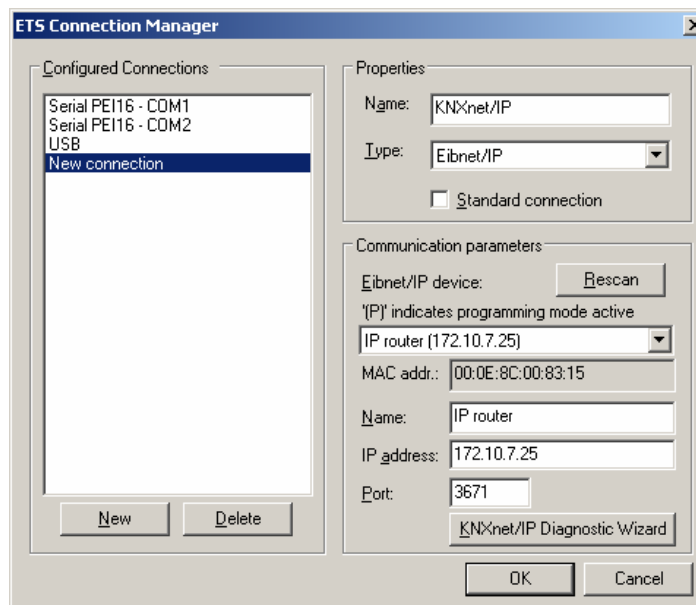

Fig. 8: Complete interface configuration of the IP router

6. For stable communication via KNXnet/IP Tunneling, a second physical address (similar to the local physical address with an RS232 or a USB link) must be specified. To do so, select the new KNXnet/IP connection (cf. Fig. 9) in the options dialog of the communication tab and click on the "Settings" button.

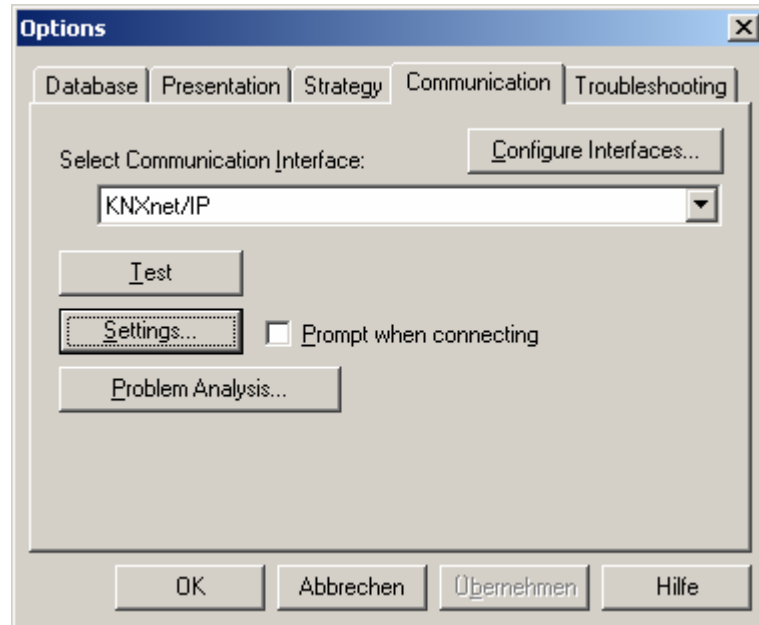

Fig. 9: Selecting the KNXnet/IP as communication interface and activating the settings

7. The local interface settings are accessible (cf. Fig. 10). Enter the physical address of the IP data interface in the "Individual address" field. It must be ensured that this address is not used by any other device in the ETS project (in case of doubt, verify with the "Is this address free?" button). After successful assignment of an address, a dummy device should be inserted in the topologically correct place. The device is delivered with physical address "15.15.255". A click on "OK" terminates the configuration of the IP data interface. The IP connection can now be used.



Fig. 10: Local interface settings

- i** In conjunction with the IP router, the driver for bus communication of the ETS 3 does not support the "Diagnosis bus monitor" function and no local download of the application program.
- i** After installation of the ETS3.0c and release of the IP router as a communication interface, a Windows fault message informing the user that the "class" is unknown may be displayed. In this case, the Microsoft.Net Framework is to be installed the latest version of which can be downloaded from the Microsoft Update Page in the Internet.

IP address assignment

The IP address of the IP router is assigned manually in the ETS or automatically by a DHCP server in the IP network. Assignment of the IP address by a DHCP server permits changing the device IP address without using the ETS.



For queries in conjunction with the configuration of the device IP address, subnet mask and DHCP parameters the network administrator should be consulted.

Default factory settings



By default, the EIBnet/IP Routing function is active. When two IP routers are interconnected via a cross-over cable or when several IP routers are interconnected via a hub or a switch, bus telegrams are routed via the IP routers without any changes.

The following parameters are set:

- Physical address of the IP router: 15.15.0.
- Group telegrams are filtered.
- The IP router acknowledges routed telegrams only.
- Support with non-parameterized interfaces whose physical address is not compatible with the line.
- Broadcast telegrams are routed
- The bus line is monitored for voltage failure.
- IP address assignment via DHCP.

Parameters		
Description	Values:	Comment:
 General		
Support of non-configured interfaces	disabled enabled	This parameter can be used for supporting data interfaces (RS232 or USB) with a topologically incorrect physical address (setting "enabled"). This permits commissioning also with non-parameterized interfaces over several lines.
Monitoring of bus voltage failure	disabled enabled	A bus voltage failure and a bus voltage recovery can be reported via the KNXnet/IP, for instance to the ETS3 or to another application.
Device name (max. 30 characters)	30-character text, IP router	This parameter determines a unique name with 30 characters max. for the IP router, which is used for easy identification of the device when searched by a KNXnet/IP visualization or the ETS.
 Routing (Bus > IP)		
Group telegrams of main groups 0 to 13	for test operation only: transmit all block filter (normal)	<p>Defines whether group telegrams of groups 0 to 13 from the bus will be transmitted on the KNXnet/IP.</p> <p>All group telegrams will be transmitted. The filter table will be disregarded. This setting should be parameterized for testing purposes only or during initial start-up of a KNX/EIB installation.</p> <p>All group telegrams will be blocked. No group telegram can pass the IP router.</p> <p>In accordance with the filter table generated and programmed in the ETS, group telegrams are either transmitted or blocked selectively.</p>
Group telegrams of main groups 14 and 15	block transmit all	<p>Defines whether group telegrams of groups 14 to 15 from the bus will be transmitted on the KNXnet/IP.</p> <p>Main groups 14 and 15 are not programmed into the filter table. This parameter defines whether these main groups are to be filtered or not.</p> <p>All group telegrams with main group 14 or 15 are blocked.</p> <p>All group telegrams with main group 14 or 15 are transmitted.</p>

<p>Individually addressed and broadcast telegrams</p>	<p>for test operation only: transmit all</p> <p>block</p> <p>filter (normal)</p>	<p>This parameter is used to set the filter function KNXnet/IP > Bus of the individually addressed telegrams and broadcast telegrams.</p> <p>All individually addressed telegrams and all broadcast telegrams are transmitted. This setting should be parameterized for testing purposes only or during initial start-up of a KNX/EIB installation.</p> <p>All individually addressed telegrams and all broadcast telegrams are blocked.</p> <p>In accordance with the individual address of the IP router, individually addressed telegrams are either transmitted or blocked selectively. Broadcast telegrams are routed</p>
<p> IP Config 1</p>		
<p>IP address assignment</p> <p>IP routing multicast address</p> <p>Byte 1 (224 ... 239) Byte 2 (224 ... 239) Byte 3 (224 ... 239) Byte 4 (224 ... 239)</p>	<p>from DHCP service</p> <p>manual entry</p> <p>224 ... 239; 224 0 ... 255; 0 0 ... 255; 23 0 ... 255; 12</p>	<p>This parameter defines how the IP address is assigned.</p> <p>The required addresses are assigned to the IP router by a DHCP server in the network.</p> <p>The required IP addresses must be entered manually in the ETS. Parameter cards "IP Config 2" and "IP Config 3" are enabled.</p> <p>Note: The required setting should be fixed in cooperation with the responsible network administrator.</p> <p>This parameter is used to set the KNXnet/IP routing address. KNXnet/IP routing is used for routing bus telegrams from an IP router to all other IP routers. In this case, only those IP routers that use the same IP routing multicast address will communicate with one another.</p> <p>The IP routing multicast address preset at the factory is 224.0.23.12. This address is assigned to KNXnet/IP routing and reserved for this special of application. For general use in a network, all addresses from 239.0.0.0 to 239.255.255.255 are, however, available.</p> <p>The four bytes of the IP routing multicast address are set one by one. This results in the well-known dot notation of an IP address: byte 1 . byte 2 . byte 3 . byte 4.</p>

 IP Config 2 (visible only in case of manual IP address assignment)		
IP address		In case of manual IP address assignment, the IP address of the IP router is set here.
Byte 1	0 ... 255; 0	<p>The factory-set value for the IP address is 0.0.0.0. This default value must be replaced by a valid IP address.</p> <p>The four bytes of the IP address are set one by one. This results in the well-known dot notation of an IP address: byte 1 . byte 2 . byte 3 . byte 4.</p>
Byte 2	0 ... 255; 0	
Byte 3	0 ... 255; 0	
Byte 4	0 ... 255; 0	
IP Subnet Mask		In case of manual IP address assignment, the IP subnet mask of the IP router is set here.
Byte 1 (224 ... 239)	0 ... 255; 0	<p>The factory-set value for the subnet mask is 0.0.0.0. This default value must be replaced by a valid subnet mask. Valid subnet masks are, for instance: 255.255.255.0 or 255.255.240.0.</p> <p>The four bytes of the subnet mask are set one by one. This results in the well-known dot notation of a subnet mask: byte 1 . byte 2 . byte 3 . byte 4.</p>
Byte 2 (224 ... 239)	0 ... 255; 0	
Byte 3 (224 ... 239)	0 ... 255; 0	
Byte 4 (224 ... 239)	0 ... 255; 0	
 IP Config 3 (visible only in case of manual IP address assignment)		
IP Standard Gateway		In case of manual IP address assignment, the IP address of the IP router is set here.
Byte 1 (224 ... 239)	0 ... 255; 0	<p>The factory-set value for the IP address is 0.0.0.0. This default value must be replaced by a valid IP address.</p> <p>The Standard Gateway (e.g. a router) is used for transmitting IP telegrams addressed to a PC outside the local network. This is required, for instance, in case of a remote access via KNXnet/IP Tunneling (function of IP router as data interface).</p> <p>If the device is to be parameterized and used without a Standard Gateway, the predefined (invalid) address is to be used (0.0.0.0).</p> <p>The four bytes of the IP address are set one by one. This results in the well-known dot notation of an IP address: byte 1 . byte 2 . byte 3 . byte 4.</p>
Byte 2 (224 ... 239)	0 ... 255; 0	
Byte 3 (224 ... 239)	0 ... 255; 0	
Byte 4 (224 ... 239)	0 ... 255; 0	

Software information

- The IP router can be parameterized from ETS2V12 onwards.
- The IP router can be reset to the default factory settings by turning on the supply voltage (external 24 V AC/DC supply) while the programming button is kept depressed for more than six seconds. The transition to the default state is indicated by a blinking programming LED. By this measure, all parameter settings are set back to the default values.
- In conjunction with the IP router, the driver for bus communication of the ETS 3 does not support the "Diagnosis bus monitor" function and no local download of the application program.
- After installation of the ETS3.0c and release of the IP router as a communication interface, a Windows fault message informing the user that the "class" is unknown may be displayed.
In this case, the Microsoft.Net Framework is to be installed the latest version of which can be downloaded from the Microsoft Update Page in the Internet.

MAXIMUM FLEXIBILITY DUE TO MODULAR DESIGN

Push-button module with integrated bus coupling unit

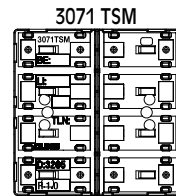

Standard push-button module with BCU, 1-gang

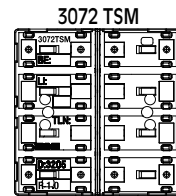

Standard push-button module with BCU, 2-gang



Cover for push-button module 2-gang



Cover for push-button module 4-gang

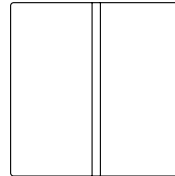

Cover for push-button module 1-gang

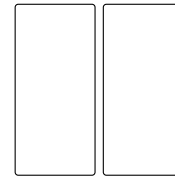

Cover for push-button module 2-gang

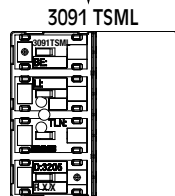

Universal push-button module with white illuminated inscription field and BCU, 1-gang

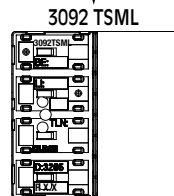

Universal push-button module with white illuminated inscription field and BCU, 2-gang

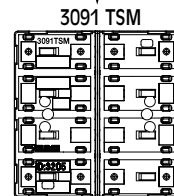

Universal push-button module with BCU, 1-gang

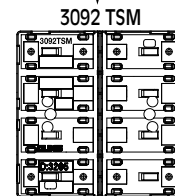

Universal push-button module with BCU, 2-gang

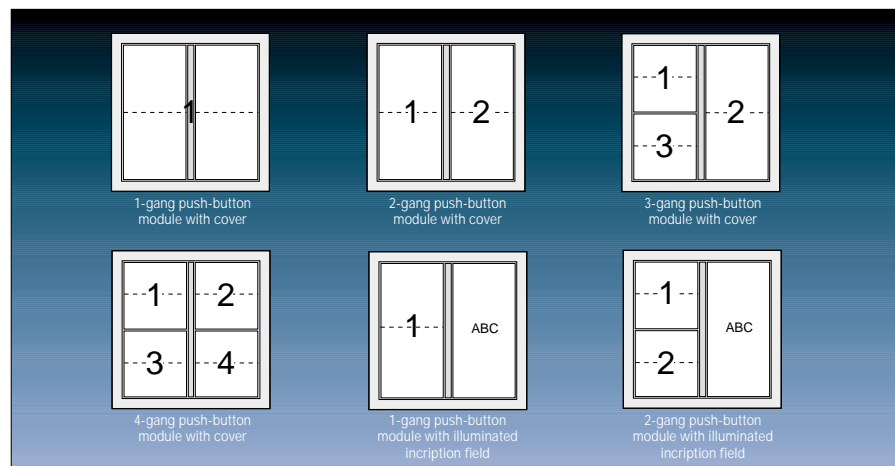

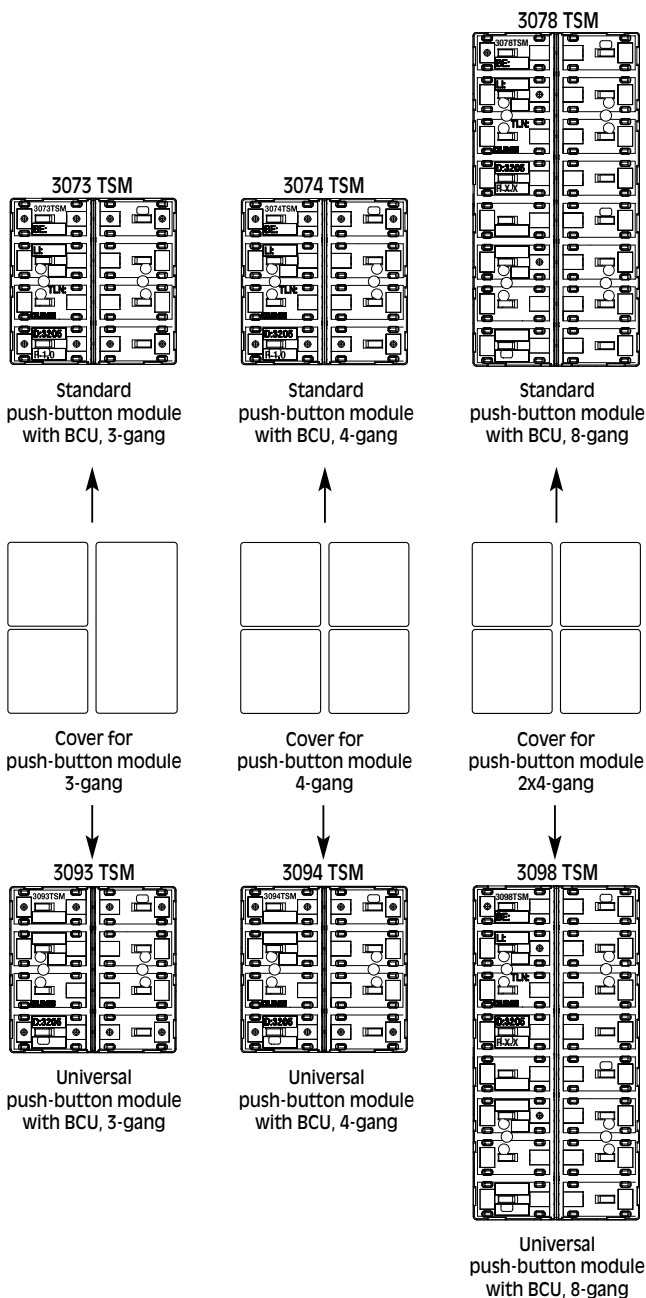

The new generation of FD modules is already fitted at the factory with an integrated bus coupler. This saves time and money during the installation. The devices are parameterised via the push-buttons and not via the bus coupler as usual. The range incorporates two variants: standard and universal for 1- to 4-gang covers. The 8-gang push-button module is completely new and offers up to 16 functions. There is also a version with an illuminated labelling field in 1- and 2-gang versions.

The new FD modules offer a further plus point for architectural creativity since the current 30 series can now be combined with the frames of the LS design. The installation is carried out via a supporting frame which is supplied with the respective push-button module. The snapshots indicate the difference between the two installations. When installing FD frames, the collar is aligned with the flush-type box. When using the LS design, it points towards the frame. This special design creates the requirement for integrating modules both in the flat FD frames and the conventional LS frames. The visual effect is equally convincing in both versions.



FD-design

FD Standard push-button module

1

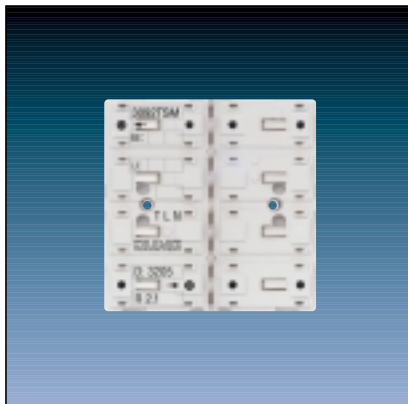
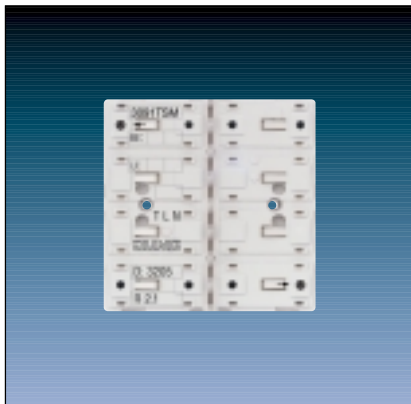

2

	Ref.-No.
FD Standard push-button module with integrated BCU	
1-gang	3071 TSM
2-gang	3072 TSM

3

After a press on the key, the push-button module will transmit software-dependent telegrams to the KNX. These may be telegrams for switching, push-button operation, dimming or for shutter control. It is also possible to program value-transmitting functions such as dimming value transmitter or light-scene extension units. The 1- and 2-gang versions allow also mixed applications. A blue operation LED can serve as orientation lighting.

4

Technical data:

KNX supply	
Voltage:	21 – 32 V DC (SELV)
Power consumption:	typically 150 mW
Connection:	Bus terminal (KNX Typ 5.1)
External supply:	–
Protection:	IP 20
Safety class:	III
Mark of approval:	KNX
Ambient temperature:	–5°C ... +45°C
Storage/transport temperature:	–25°C ... +70°C (storage above +45°C reduces the lifetime)
Mounting position:	any
Minimum distances:	none
Fastening:	Fixing to the supporting frame by means of the attached plastic screws

5 Software Applications:

No.	Summarized description		Version
1	Switching, status	Switching, status 100312	1.2
2	Switching, acknowledgement	Switching, acknowledgement 100A12	1.2
3	Dimming	Dimming 102A01	0.1
4	Shutter	Shutter 102B01	0.1
5	Shutter with status object	Shutter with status object 108C01	0.1
6	Dimming/shutter	Dimming/shutter 103A01	0.1
7	Switching/dimming	Switching/dimming 103C01	0.1
8	Switching/shutter	Switching/shutter 103B01	0.1
9	Switching/push-button operation	Switching/push-button operation 103101	0.1
10	Value transmitter	Value transmitter 101C01	0.1

Scope of functions:

Switching

- Function of operating LED and of status LED parameterizable.
- Command on key-press parameterizable (ON, OFF).
- The status LED indicates the current state of the object. If a key is pressed (e.g. ON) and if the push-button module does not get a positive acknowledgement (IACK) from an addressed actuator, the object status is updated, but the corresponding status LED is not lit up.
- Within application "Switching, acknowledgement" the status LED is ON for a parameterizable time in case of a positive acknowledgement from an addressed actuator.

Dimming

- Function of operating LED and of status LED parameterizable.

Shutter

- Both, the operation and also the status LED can be controlled by separate objects (status indication) or be permanently ON or OFF. The status LED can additionally act as key-press indicators.
- Operating concept for shutter control parameterizable.
- Time between short-time and long-time operation and slat adjustment time presettable depending on operating concept.
- Rocker configuration and key functions presettable.

Light-scene extension unit / Value transmitter

- When a key is pressed for less than 1 s, the parameterised light-scene is recalled and the pertaining status LED switched on for about 1 s. If a key is pressed during a light-scene recall with storage function for more than 5 s, a storage telegram corresponding to the parameterised light-scene will be transmitted and the status LED is lit up for 4 s. Pressing a key with storage function for a time between 1 s and 5 s is without effect.
- The status LED lights up after a key-press only in conjunction with a positive acknowledgement (IACK) from an addressed actuator.
- Function of operating LED and of status LED parameterizable.
- Mode of operation (value transmitter/light-scene recall with/without storage function) freely selectable.
- Values (1 byte) or light-scene numbers (1 ... 8) for all keys individually parameterizable.

FD-design

FD Standard push-button module

1

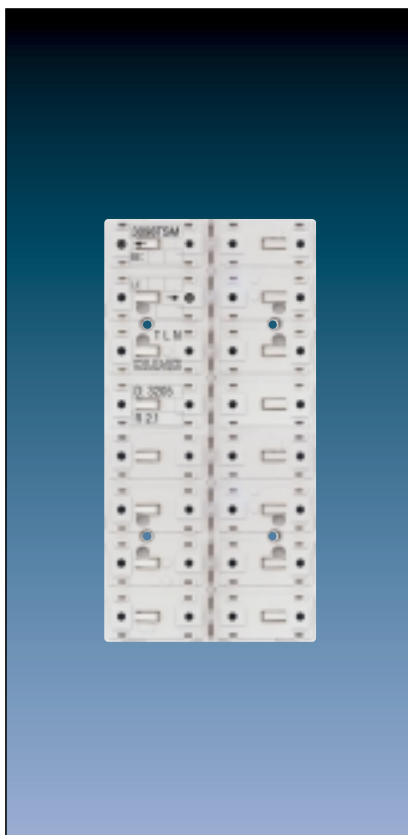
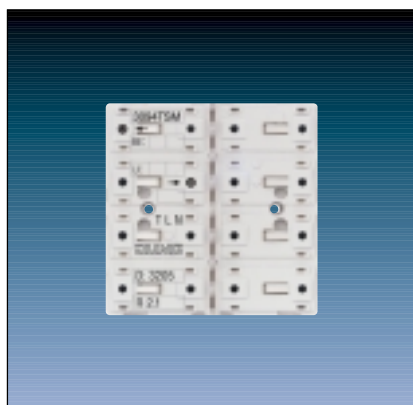
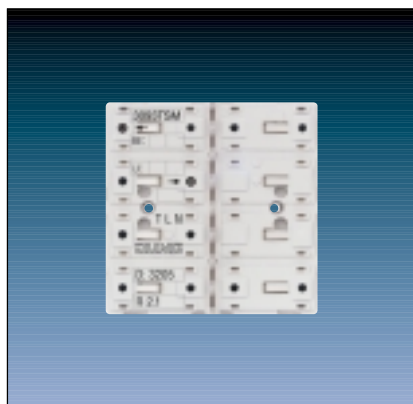

2

Ref.-No.

FD Standard push-button module
with integrated BCU
3-gang
4-gang
8-gang

3073 TSM
3074 TSM
3078 TSM

3

After a press on the key, the push-button module will transmit software-dependent telegrams to the KNX. These may be telegrams for switching, push-button operation, dimming or for shutter control. It is also possible to program value-transmitting functions such as dimming value transmitter or light-scene extension units.

A blue operation LED can serve as orientation lighting.

5

Software Applications:

No.	Summarized description		Version
1	Switching, status	Switching, status 102E01	0.1
2	Switching, acknowledgement	Switching, acknowledgement 102F01	0.1
3	Dimming	Dimming 102D01	0.1
4	Shutter	Shutter 102C01	0.1
5	Value transmitter	Value transmitter 101D01	0.1

FD-design

FD Universal push-button module

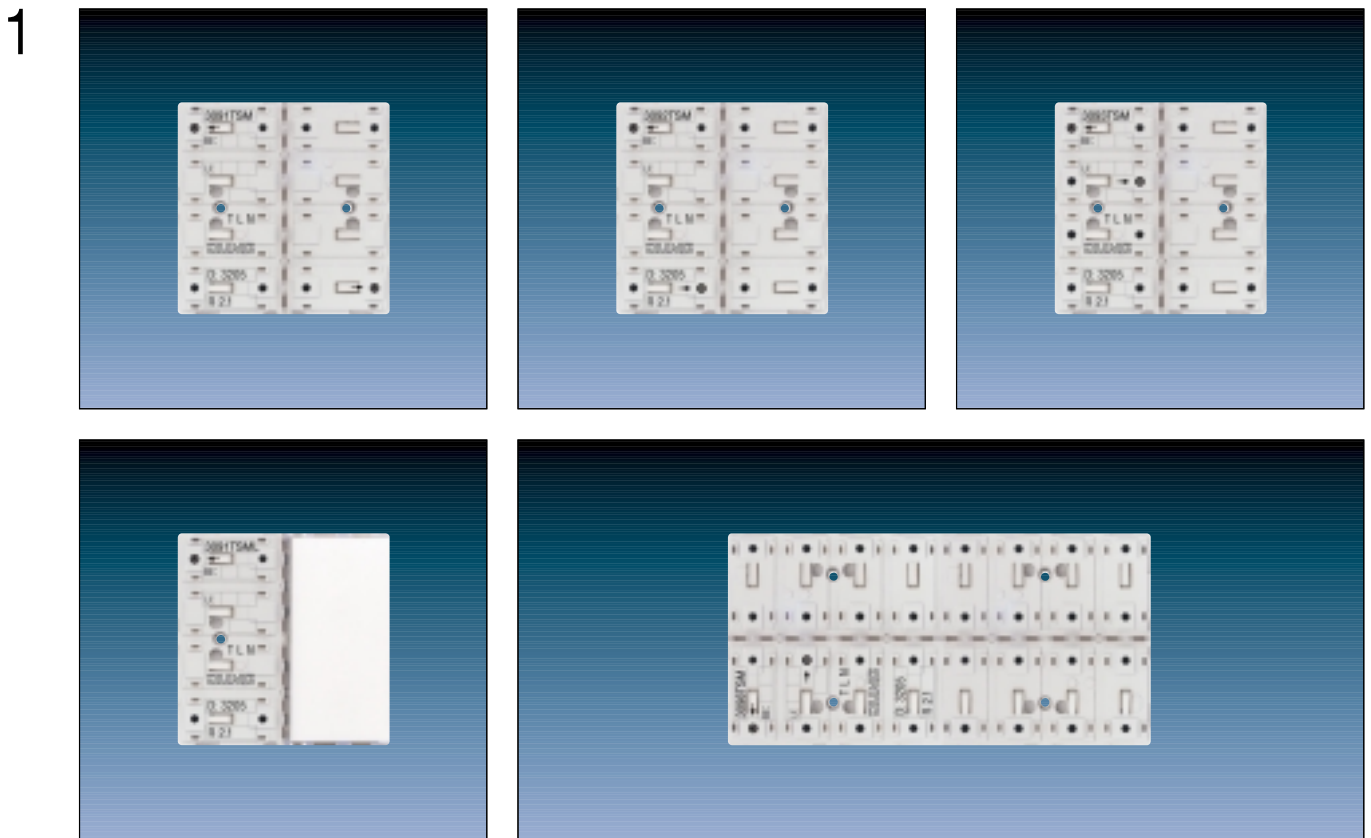

2

	Ref.-No.
FD Universal push-button module with integrated BCU	
1-gang	3091 TSM
2-gang	3092 TSM
3-gang	3093 TSM
4-gang	3094 TSM
8-gang	3098 TSM
with illuminated inscription field	
1-gang	3091 TSML
2-gang	3092 TSML

3 The FD universal push-button module is connected directly to the bus line and fixed to the metal supporting frame by means of the attached plastic screws.

Each of the square buttons can be used as one rocker or as two separate push-buttons (keys). The button can be operated either vertically or horizontally.

If a button is used as one rocker, with certain functions additional special functions can be called up by pressing the rocker centrally.

Depending on the adjusted function, it sends telegrams, e.g. to actuators for switching ON/OFF lights, for dimming lights, for recalling or saving light scenes, for moving shutters/blinds up or down and for adjusting louvers or value transmitter functions like dimming value, brightness value, light scene extension or temperature values.

Each button has two red LED which can be switched permanently ON or OFF, be used as status or operation indication or be controlled by a separate object.

A blue LED can serve as an orientating light, can be switched ON or OFF permanently or be controlled by a separate object.

The FD universal push-button modules have to be equipped with the chosen design covers.

The metal supporting frame can be turned. This way, it is possible to use the FD push-button module either with the special FD frames or with the standard LS 990, LS plus, ES, AL, AN, GO frames.

4 Technical data:

KNX supply	
Voltage:	21 – 32 V DC (SELV)
Power consumption:	typically 150 mW
Connection:	Bus terminal (KNX Typ 5.1)
External supply:	–
Protection:	IP 20
Safety class:	III
Mark of approval:	KNX
Ambient temperature:	–5°C ... +45°C
Storage/transport temperature:	–25°C ... +70°C (storage above +45°C reduces the lifetime)
Mounting position:	any
Minimum distances:	none
Fastening:	Fixing to the supporting frame by means of the attached plastic screws

Mounting:
(8-gang version)

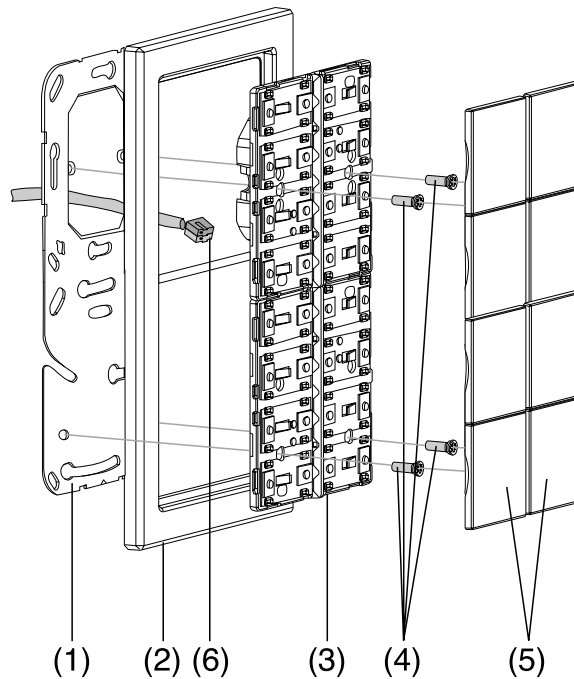

- a. Metal supporting frame (1) to be mounted on a wall box. Marking "TOP" = on top; "A" in front for FD frame or "B" uin front for LS 990.
- b. Attach design-frame (2) onto the supporting frame.
- c. Connect push-button module (3) with standard bus terminal (6) to the KNX, and attach it to the supporting frame.
- d. Fix the push-button module (3) to the supporting frame by means of the plastic screw (4)
(dismounting/burglar protection) screw the plastic screws slightly only.
- e. Download the physical address to the device before mounting the design covers (5).

ONLY for version 8-gang:

When mounting on a single wall box (no wall box under the lower part) generate space for the lower plastic screws in the wall, approx. 10 mm (e.g. drill 6 mm). use the supporting frame for positioning.

5 Special features:

8-gang, Ref.-No. 3098 TSM

The device has an integrated temperature sensor. This way, the device can be integrated in the room temperature measurement in connection with e.g. a Room Controller (RCD) or to indicate the temperature on any display.

1-gang, Ref.-No. 3091 TSML

2-gang, Ref.-No. 3092 TSML

The devices offer an illuminated inscription field. The illumination with white LED can be switched ON or OFF permanently or be controlled by a separate object.

Scope of functions:

- Each button can be used as one rocker or as two separate push-buttons. The button can be operated either vertically or horizontally.
- Each button can be used for switching, dimming, shutter/blinds, value transmitter 1 or 2 byte or light scene extension.
- For each rocker or push-button, the operation of two independent channels can be adjusted while both channels have the same functions as a single push-button.
- For each button, two status LED are available.
- If a status LED is linked internally to a rocker/push-button, it can display the operation or the current status of a communication object.
- If a status LED is used independent of a rocker/push-button, it can be switched ON or OFF permanently, display the status of an own communication object, display the status of a room temperature sensor or the result of a comparator of 1 byte values with or without algebraic sign.
- The blue operation LED can be switched ON or OFF permanently, turned into a flashing mode, or be controlled by a communication object.
- Depending on the adjusted basic function, a rocker can also evaluate a centered push.
- In switching functions the reaction on pressing/releasing, switch ON, switch OFF or toggling can be adjusted.
- In dimming functions the adjustment for single level/two level control, times for short and long operation, dimming in steps, telegram repetition at long operation and a stop telegram at the end of operation is possible.
- In shutter function the single level/two level control, four different operation concepts, times for short and long operation and the blades adjustment can be defined.
- In the 1 or 2 byte value transmitter it is possible to adjust the range (0 ... 100 %, 0 ... 255, 0 ... 65535, 0 ... 1500 LUX, 0 ... 40°C), the value when pressing, value adjustment at long operation with various step width, times for an optional over flow when reaching the end of the value range.
- In light scene control it is possible to adjust: the internal storing of eight light scenes with eight output channels, the recall of the internal light scenes by an adjustable light scene number, the object type of the outputs, the blocking or releasing of the single output values of a light scene, the sending delay time for the single outputs.
In the light scene extension function up to 64 light scenes can be recalled and stored.
- When used as a temperature controller satellite, adjustments are possible for:
Changing between the operation modes with high or normal priority, defined choose of an operation mode, changing of the presence status, set value adjustment.
- All rocker/push-buttons can be inhibited by a 1 bit object. The polarity of the inhibit object and the behavior at the beginning of inhibit can be set. During an active locking, all rocker/push-buttons or single rocker/push-buttons can be without function, can release the function of a selected rocker/push-button or carry out one of two adjustable inhibit functions.
- All LEDs of the sensor can blink at the same time, e.g. to display an alarm.
The value of the alarm object for the conditions alarm/no alarm, acknowledge of the alarm by pushing a button, transmitting the ACK to other devices can be adjusted.

Pushbutton sensor Universal TSM

1-, 2-, 3-, 4-, 8- gang

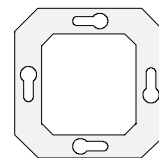

Sensor

Product name:	Pushbutton sensor Universal TSM 1-, 2-, 3-, 4-, 8-gang																			
Design:	UP (flush-mounting type)																			
Article-no.:	see below																			
ETS search path:	Push button / push button x-gang / push button x-gang Universal TSM (x = 1, 2, 3, 4, 8)																			
Issue:	07.12.2006																			
Functional description:	<p>On the press of a key and depending on the parameters programmed, the pushbutton sensor Universal TSM transmits telegrams to the KNX / EIB. These can be, for instance, telegrams for switching or momentary-contact control, for dimming or for shutter control. It is also possible to program value transmitter functions such as dimming value transmitters, light-scene extensions, temperature value transmitters or brightness value transmitters.</p> <p>In conjunction with a room temperature controller equipped with a 1-byte object for switching over the modes of operation the pushbutton sensor Universal TSM can be used as a full-featured controller extension unit. The device can also be used for presence detection or for reference value shifting purposes.</p> <p>An integrated temperature sensor in the pushbutton sensor Universal TSM 8-gang permits measuring and transmitting the room temperature. Central heating control units that are not equipped with a temperature sensor of their own can thus be integrated into the KNX / EIB room temperature control. For an improved detection of the temperature distribution in a room, the pushbutton sensor can moreover be used as an extension unit to a room temperature controller.</p> <p>Each of the eight square-shaped control surfaces of the pushbutton sensor Universal TSM can be used optionally as a rocker or as two separate keys with the possibility of dividing the control surfaces either vertically or horizontally. When a control surface is configured as a rocker, it is also possible with some functions to trigger special functions by a press on the whole surface of the rocker.</p> <p>The pushbutton sensor Universal TSM is equipped with two status LEDs per control surface. These status LEDs can optionally either be permanently on or off, or otherwise act as an actuation or status indicator for a key or a rocker. As an alternative, the LED can also be controlled via separate communication objects. The status LEDs can then also signal the operating states of room temperature controllers or indicate the results of logic value comparisons.</p> <p>A blue operation LED can optionally serve as an orientation light (steady or also flashing) or be controlled via an independent communication object. When the pushbutton sensor is in the programming mode, the operation LED flashes with a frequency of about 8 Hz. The same flashing rate is also used for indicating that a rocker has been actuated by a press on the full surface; in this case the flashing rate returns to the programmed behaviour after the actuation. If no or a wrong application has been loaded into the pushbutton sensor, the operation LED flashes with a frequency of abt. 0.75 Hz to indicate an error and the pushbutton sensor does not work.</p> <p>The pushbutton sensor Universal TSM is equipped with an internal BCU and can be connected directly to the bus line (cf. wiring diagram). The pushbutton sensor is fastened on a supporting ring with plastic screws supplied with the device.</p>																			
Article numbers:	<table border="1"> <thead> <tr> <th>Pushbutton sensor model</th> <th>Jung article no.</th> <th></th> </tr> </thead> <tbody> <tr> <td>Pushbutton sensor Universal TSM 1-gang</td> <td>3091 TSM</td> <td></td> </tr> <tr> <td>Pushbutton sensor Universal TSM 2-gang</td> <td>3092 TSM</td> <td></td> </tr> <tr> <td>Pushbutton sensor Universal TSM 3-gang</td> <td>3093 TSM</td> <td></td> </tr> <tr> <td>Pushbutton sensor Universal TSM 4-gang</td> <td>3094 TSM</td> <td></td> </tr> <tr> <td>Pushbutton sensor Universal TSM 8-gang</td> <td>3098 TSM</td> <td></td> </tr> </tbody> </table>		Pushbutton sensor model	Jung article no.		Pushbutton sensor Universal TSM 1-gang	3091 TSM		Pushbutton sensor Universal TSM 2-gang	3092 TSM		Pushbutton sensor Universal TSM 3-gang	3093 TSM		Pushbutton sensor Universal TSM 4-gang	3094 TSM		Pushbutton sensor Universal TSM 8-gang	3098 TSM	
Pushbutton sensor model	Jung article no.																			
Pushbutton sensor Universal TSM 1-gang	3091 TSM																			
Pushbutton sensor Universal TSM 2-gang	3092 TSM																			
Pushbutton sensor Universal TSM 3-gang	3093 TSM																			
Pushbutton sensor Universal TSM 4-gang	3094 TSM																			
Pushbutton sensor Universal TSM 8-gang	3098 TSM																			

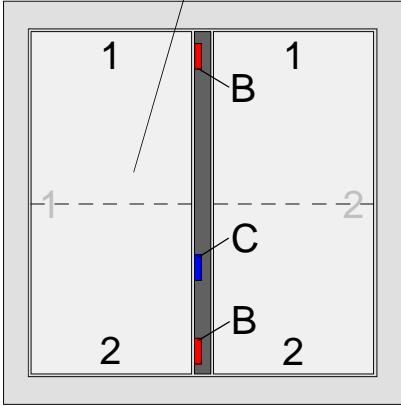
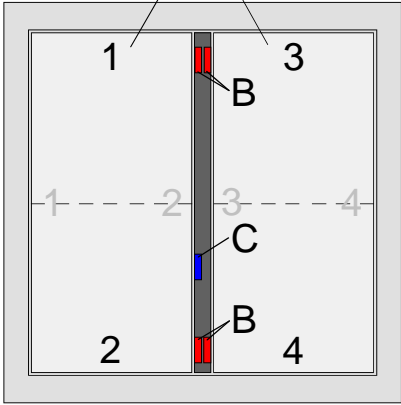
<p>Illustration:</p> <p>1- gang</p> 	<p>Dimensions:</p> <p>Width: 70 mm (without frame)</p> <p>Height: 70 mm (without frame)</p> <p>Depth: 20 mm (including flush-mounting box)</p>	<p>Controls:</p> <p>A: 1 control surface configurable as a rocker (1) or as keys (1...2). The layout of the control keys can be parameterized: top and bottom or left and right.</p> <p>For operation, the device must be equipped with the corresponding pushbutton sensor module cover used as control surface. The cover must be ordered separately: 1 x FD...901 TSA..</p> <p>B: 2 status LEDs (red)</p> <p>C: 1 operation LED (blue)</p>
<p>2- gang</p> 	<p>Dimensions:</p> <p>Width: 70 mm (without frame)</p> <p>Height: 70 mm (without frame)</p> <p>Depth: 20 mm (including flush-mounting box)</p>	<p>Controls:</p> <p>A: 2 control surfaces configurable as rockers (1...2) or as keys (1...4). The layout of the control keys can be parameterized: top and bottom or left and right.</p> <p>For operation, the device must be equipped with the corresponding pushbutton sensor module covers used as control surfaces. The covers must be ordered separately: 2 x FD...902 TSA..</p> <p>B: 4 status LEDs (red) two per control surface.</p> <p>C: 1 operation LED (blue)</p>

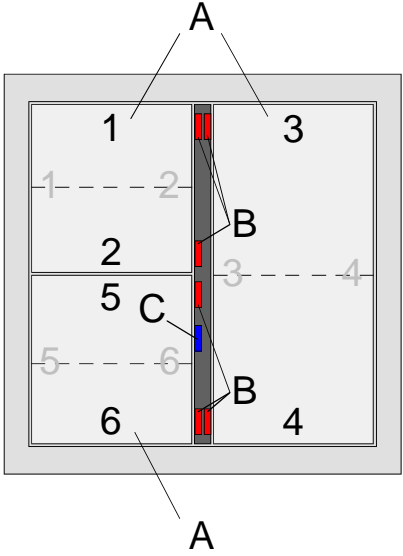
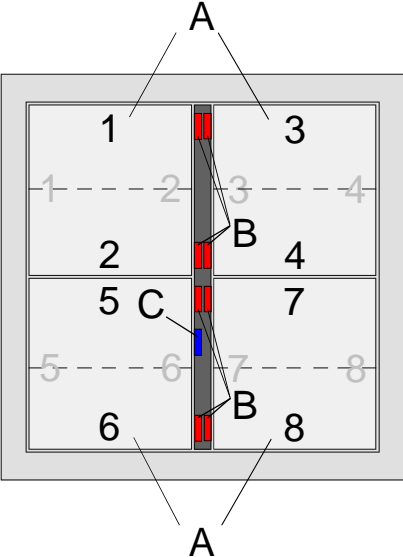
<p style="text-align: center;">3- gang</p> 	<p>Width: 70 mm (without frame)</p> <p>Height: 70 mm (without frame)</p> <p>Depth: 20 mm (including flush-mounting box)</p>	<p>A: 3 control surfaces configurable as rockers (1...3) or as keys (1...6). The layout of the control keys can be parameterized: top and bottom or left and right.</p> <p>For operation, the device must be equipped with the corresponding pushbutton sensor module covers used as control surfaces. The covers must be ordered separately: 2 x FD...904 TSA.. 1 x FD...902 TSA..</p> <p>B: 6 status LEDs (red) two per control surface.</p> <p>C: 1 operation LED (blue)</p>
<p style="text-align: center;">4- gang</p> 	<p>Width: 70 mm (without frame)</p> <p>Height: 70 mm (without frame)</p> <p>Depth: 20 mm (including flush-mounting box)</p>	<p>A: 4 control surfaces configurable as rockers (1...4) or as keys (1...8). The layout of the control keys can be parameterized: top and bottom or left and right.</p> <p>For operation, the device must be equipped with the corresponding pushbutton sensor module covers used as control surfaces. The covers must be ordered separately: 4 x FD...904 TSA..</p> <p>B: 8 status LEDs (red) two per control surface.</p> <p>C: 1 operation LED (blue)</p>

<p>Illustration:</p> <p style="text-align: center;">8- gang</p> <p>The diagram shows a vertical 8-gang device with 16 control surfaces numbered 1 to 16. The surfaces are arranged in two columns of eight. A central vertical strip contains 16 LEDs, labeled 'B', and one blue LED labeled 'C' is located between surfaces 5 and 6. The device is labeled 'A' at the top and bottom corners and 'B' at the sides.</p>	<p>Dimensions:</p> <p>Width: 140 mm (without frame)</p> <p>Height: 70 mm (without frame)</p> <p>Depth: 20 mm (including flush-mounting box)</p>	<p>Controls:</p> <p>A: 8 control surfaces configurable as rockers (1...8) or as keys (1...16). The layout of the control keys can be parameterized: top and bottom or left and right.</p> <p>For operation, the device must be equipped with the corresponding pushbutton sensor module covers used as control surfaces. The covers must be ordered separately: 8 x FD...904 TSA..</p> <p>B: 16 status LEDs (red) two per control surface.</p> <p>C: 1 operation LED (blue)</p>
--	--	--

<p>Technical data</p>	
<p>Type of protection:</p> <p>Safety class:</p> <p>Mark of approval:</p> <p>Ambient temperature:</p> <p>Storage / transport temperature:</p> <p>Mounting position:</p> <p>Minimum distances:</p> <p>Type of fastening:</p>	<p>IP 20</p> <p>III</p> <p>KNX / EIB</p> <p>-5 °C ... +45 °C</p> <p>-25 °C ... +70 °C (storage above +45 °C reduces the lifetime)</p> <p>any</p> <p>none</p> <p>fastened on the supporting ring with plastic screws supplied with the device.</p>
<p>KNX / EIB supply</p> <p>Voltage:</p> <p>Power consumption:</p> <p>Connection:</p>	<p>21 – 32 V DC (SELV)</p> <p>typically 150 mW</p> <p>bus connecting terminal (KNX type 5.1)</p>
<p>External supply</p>	<p>---</p>
<p>Internal temperature sensor (8-gang version only):</p> <p>Measuring range:</p> <p>Resolution:</p> <p>Atmospheric humidity:</p>	<p>+ 5 °C ...+ 35 °C ±1 %</p> <p>0.1 K</p> <p>0 % ... 95 % (no condensation)</p>

Response to bus voltage failure:

Bus voltage only:

object values will be deleted, LEDs extinguished

Response to bus voltage return

Bus voltage only:

no reaction (depending on parameterization, the controller extension unit may request the object states from the controller, if necessary.)

Input:

Output:

Wiring diagram and terminals:

Example: Pushbutton sensor Universal TSM (1-, 2-, 3-, 4-gang types analogous)

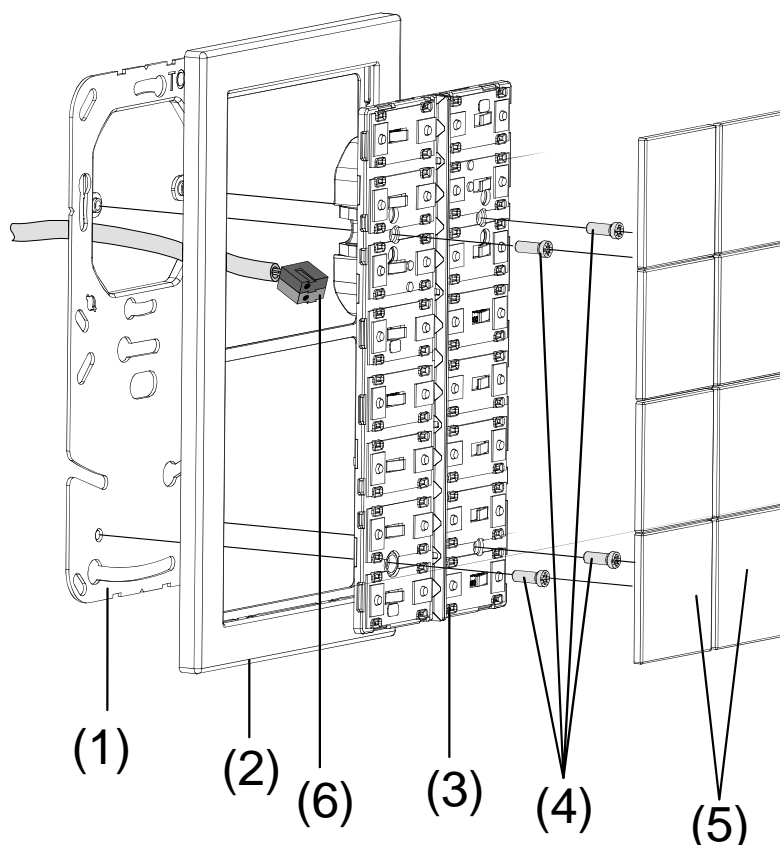

Fitting:

1. Fit supporting ring (1) in correct position on a flush-mounting box (DIN 49073) ("TOP" mark = up; "Type A" or "Type B" in front). Use the screws supplied with the box.
2. Place decorative frame (2) on the supporting ring.
3. Connect the pushbutton sensor module (3) with the standard bus connecting terminal (6) to the KNX/EIB and plug onto supporting ring (lead bus wires out at the bottom).
4. Fasten the pushbutton sensor module with the plastic screws supplied (4) on the supporting ring (protection against removal or theft). Tighten the plastic screws without using force. Pushbutton sensor Universal TSM 8-gang: in case of fitting on a single flush-mounting box, the lower fastening screws need a 10 mm wide opening (e.g. borehole 6 mm). Use the supporting ring as a template.
5. Before fitting the covers (5) load the physical address into the device (cf. "Commissioning").

Fitting of the key covers:

Place the covers one by one on the touch sensor module. When the cover is in the correct position, snap it on with a brief press.

Commissioning

After connecting the pushbutton sensor Universal TSM to the bus, it can be put into operation. The start-up procedure is basically confined to programming with the ETS.

I. Assignment of the physical address

The pushbutton sensor Universal TSM is equipped with an integrated BCU. The pushbutton sensor has no separate programming key or LED. The programming mode is activated by a defined and time-delayed press on the first rocker and signalled by the operation LED. For programming of the physical address, the module covers must not be in place on the device.

The physical address is programmed as described below...

1. Activate the programming mode (cf. Fig. 1):

Press button (1) and keep it depressed.

Then press button (2). The location of the second button depends on the pushbutton sensor model. The programming mode is activated. The operation LED flashes fast (approx. 8 Hz).

Notes:

Use suitable tools for pressing the buttons (e.g. small screwdriver, tip of ballpoint pen, etc).

- To exclude any inadvertent activation of the programming mode during a 'normal' use of the control surface in later operation, the time between the first and the second key actuation must be at least 200 ms. A simultaneous press of both keys (time between first and second key-press < 200 ms) will not result in an activation of the programming mode.

It should be noted that the operation LED starts flashing fast also in case of a full-surface actuation of rocker 1. The difference between fast flashing in this case and fast flashing in the programming mode is that - in case of a full-surface actuation of the rocker - the flashing rate falls back into the programmed basic behaviour when the key is released. In the programming mode, the flashing rate remains the same until the mode is ended. The state of the LED defined by the programming mode will always prevail.

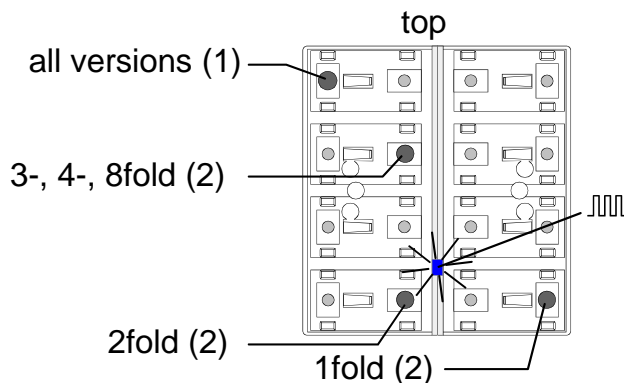

Fig. 1: Keys for activation of the programming mode

2. Program the physical address with the help of the ETS.

3. The programming mode ends:

- automatically after adoption of the physical address
- by pressing a key.

Note:

- If the programming mode is to be activated or deactivated in a device which is already programmed with a valid application, there is the possibility that telegrams will be transmitted to the bus at the time the key is pressed. The telegram transmitted depends on the key function programmed.

II. Programming of the application

The application is to be programmed thereafter into the device with the help of the ETS. The ETS3.0 from version "d" onwards detects automatically whether a valid application has already been programmed into the device before. To reduce the programming time, the ETS3 downloads the whole application only if the device was programmed beforehand with another application or with no application at all. In all other cases, the ETS makes a time-optimized partial download in which only the modified data are loaded into the device.

Depending on the programming command, the ETS2 programs the application for the pushbutton sensor either completely or partially for parameters and group addresses. The time-optimized download procedure of the ETS3.0d is not available in this version.

For start-up purposes, it is recommended to use the ETS3.0 from version "d" onwards.

Condition at delivery from the factory and wrong application

As long as pushbutton sensor Universal TSM has not yet been programmed with application data by means of the ETS, the blue operation LED flashes at a slow rate (approx. 0.75 Hz). When any of the keys or rockers is pressed, the pertaining status LED lights up briefly (key-press indication). This condition persists until the application is programmed into the device.

By slow flashing of its operation LED (approx. 0.75 Hz), the pushbutton sensor can also indicate that a wrong application has been programmed into its memory with the ETS. Applications are wrong applications, if they are not intended for use with the pushbutton sensor Universal TSM in the ETS product database. Attention must also be paid to the fact that the pushbutton sensor variant is compatible with the one in the project (e. g. 8-gang version designed in the ETS project, installed and also programmed).

The operation LED flashes slowly also if the application program of the touch sensor has been removed from the device by the ETS.

In both cases, the pushbutton sensor is not operational.

Hardware information

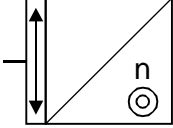
Software information			
ETS search path:		ETS symbol:	
Pushbutton / pushbutton, 8-gang / pushbutton Universal TSM, 1-gang Pushbutton / pushbutton, 8-gang / pushbutton Universal TSM, 2-gang Pushbutton / pushbutton, 8-gang / pushbutton Universal TSM, 3-gang Pushbutton / pushbutton, 8-gang / pushbutton Universal TSM, 4-gang Pushbutton / pushbutton, 8-gang / pushbutton Universal TSM, 8-gang			
BAU used:	Mask 0705		
KNX/EIB type class:	3b-device with certified phase layer + stack		
Configuration:	S-mode standard		
PEI Type	00 Hex	0 Dec	
PEI connector	no connector		
Applications:			
No.	Short description:	Name:	Version:
1	Pushbutton sensor Universal TSM 1-gang	Universal 1-gang 10A001	0.1 / from ETS3.0d: 1.1
1	Pushbutton sensor Universal TSM 2-gang	Universal 2-gang 10A201	0.1 / from ETS3.0d: 1.1
1	Pushbutton sensor Universal 3-gang	Universal 1-gang 10A301	0.1 / from ETS3.0d: 1.1
1	Pushbutton sensor Universal 4-gang	Universal 4-gang 10A501	0.1 / from ETS3.0d: 1.1
1	Pushbutton sensor Universal 8-gang	Universal 8-gang 10A601	0.1 / from ETS3.0d: 1.1

Application:	Universal 8-gang 10A601		
Executable from mask version:	7.5		
Number of addresses (max):	120	dynamic table management	YES NO
Number of assignments (max):	120	maximum table length	240
Communication objects:	73 (maximum object number 74, gaps in between)		

Rocker 1...8²





















Object ³	Function	Name:	Type	DP-ID	Flag	
<input type="checkbox"/> →	0	Switching	Rocker 1	1 bit	1.xxx	C, W, T (,R) ¹
<input type="checkbox"/> →	0	Status-LED top	Rocker 1	1 bit	1.xxx	C, W (,R) ¹
<input type="checkbox"/> →	0	Short-time operation	Rocker 1	1 bit	1.007	C, T, (,R) ¹
<input type="checkbox"/> →	0	Value	Rocker 1	1 byte	5.xxx	C, W, T (,R) ¹
<input type="checkbox"/> →	0	Value	Rocker 1	2 bytes	7.xxx	C, W, T (,R) ¹
<input type="checkbox"/> →	0	Temperature value	Rocker 1	2 bytes	9.001	C, W, T (,R) ¹
<input type="checkbox"/> →	0	Brightness value	Rocker 1	2 bytes	9.004	C, W, T (,R) ¹
<input type="checkbox"/> →	0	Scene extension unit	Rocker 1	1 byte	18.001	C, T, (,R) ¹
<input type="checkbox"/> →	0	Channel 1 switching	Rocker 1	1 bit	1.xxx	C, W, T (,R) ¹
<input type="checkbox"/> →	0	Channel 1 value	Rocker 1	1 byte	5.xxx	C, T, (,R) ¹
<input type="checkbox"/> →	0	Channel 1 value	Rocker 1	2 bytes	9.001	C, T, (,R) ¹
<input type="checkbox"/> →	1	Switching	Rocker 1 full-surface actuation	1 bit	1.xxx	C, W, T (,R) ¹
<input type="checkbox"/> →	1	Scene extension unit	Rocker 1 full-surface actuation	1 byte	18.001	C, T, (,R) ¹
<input type="checkbox"/> →	1	Status LED bottom	Rocker 1	1 bit	1.xxx	C, W (,R) ¹
<input type="checkbox"/> →	18	Dimming	Rocker 1	4 bit	3.007	C, W, T (,R) ¹
<input type="checkbox"/> →	18	Long-time operation	Rocker 1	1 bit	1.008	C, W, T (,R) ¹
<input type="checkbox"/> →	18	Channel 2 switching	Rocker 1	1 bit	1.xxx	C, W, T (,R) ¹
<input type="checkbox"/> →	18	Channel 2 value	Rocker 1	1 byte	5.xxx	C, T, (,R) ¹
<input type="checkbox"/> →	18	Channel 2 value	Rocker 1	2 bytes	9.001	C, T, (,R) ¹
<input type="checkbox"/> →	36	Status-LED top	Rocker 1	1 bit	1.xxx	C, W (,R) ¹
<input type="checkbox"/> →	36	Status-LED top	Rocker 1	1 byte	20.102	C, W, (,R) ¹
<input type="checkbox"/> →	36	Status-LED top	Rocker 1	1 byte	5.xxx	C, W, (,R) ¹
<input type="checkbox"/> →	36	Status-LED top	Rocker 1	1 byte	6.xxx	C, W, (,R) ¹
<input type="checkbox"/> →	37	Status-LED bottom	Rocker 1	1 bit	1.xxx	C, W, (,R) ¹
<input type="checkbox"/> →	37	Status-LED bottom	Rocker 1	1 byte	20.102	C, W, (,R) ¹
<input type="checkbox"/> →	37	Status-LED bottom	Rocker 1	1 byte	5.xxx	C, W, (,R) ¹
<input type="checkbox"/> →	37	Status-LED bottom	Rocker 1	1 byte	6.xxx	C, W, (,R) ¹

¹: Communication objects can be read out (set L-flag).

²: Mixed operation of rocker or key functions in a pushbutton sensor is possible.

³: The objects have been described for rocker rocker 1 as an example. The object descriptions apply analogously to 2 ... max. 8 rockers with the corresponding object number.































Key 1...16 ²:

Object ⁴	Function	Name ⁴	Type	DP-ID	Flag
 0	Switching	Key 1	1 bit	1.xxx	C, W, T (,R) ¹
 0	Status-LED	Key 1	1 bit	1.xxx	C, W, (,R) ¹
 0	Short-time operation	Key 1	1 bit	1.007	C, T, (,R) ¹
 0	Value	Key 1	2 bytes	5.xxx	C, W, T (,R) ¹
 0	Value	Key 1	1 byte	7.xxx	C, W, T (,R) ¹
 0	Temperature value	Key 1	2 bytes	9.001	C, W, T (,R) ¹
 0	Brightness value	Key 1	2 bytes	9.004	C, W, T (,R) ¹
 0	Scene extension unit	Key 1	1 byte	18.001	C, T, (,R) ¹
 0	Channel 1 switching	Key 1	1 bit	1.xxx	C, W, T (,R) ¹
 0	Channel 1 value	Key 1	1 byte	5.xxx	C, T, (,R) ¹
 0	Channel 1 value	Key 1	2 bytes	9.001	C, T, (,R) ¹
 18	Dimming	Key 1	4 bit	3.007	C, W, T (,R) ¹
 18	Long-time operation	Key 1	1 bit	1.008	C, W, T (,R) ¹
 18	Channel 2 switching	Key 1	1 bit	1.xxx	C, W, T (,R) ¹
 18	Channel 2 value	Key 1	1 byte	5.xxx	C, T, (,R) ¹
 18	Channel 2 value	Key 1	2 bytes	9.001	C, T, (,R) ¹
 36	Status-LED	Key 1	1 bit	1.xxx	C, W, (,R) ¹
 36	Status-LED	Key 1	1 byte	20.102	C, W, (,R) ¹
 36	Status-LED	Key 1	1 byte	5.xxx	C, W, (,R) ¹
 36	Status-LED	Key 1	1 byte	6.xxx	C, W, (,R) ¹

¹: Communication objects can be read out (set L-flag).

²: Mixed operation of rocker or key functions in a pushbutton sensor is possible.

⁴: The objects have been described for rocker rocker 1 as an example. The object descriptions apply analogously to 2 ... max. 16 keys with the corresponding object number

Disabling functions:						
Object	Function	Name	Type	DP-ID	Flag	
 16	Switching	Disabling function 1	1 bit	1.xxx	C, W, T (,R) ¹	
 16	Short-time operation	Disabling function 1	1 bit	1.007	C, T, (,R) ¹	
 16	Value	Disabling function 1	1 byte	5.xxx	C, W, T (,R) ¹	
 16	Value	Disabling function 1	2 bytes	7.xxx	C, W, T (,R) ¹	
 16	Temperature value	Disabling function 1	2 bytes	9.001	C, W, T (,R) ¹	
 16	Brightness value	Disabling function 1	2 bytes	9.004	C, W, T (,R) ¹	
 16	Scene extension unit	Disabling function 1	1 byte	18.001	C, T, (,R) ¹	
 16	Channel 1 switching	Disabling function 1	1 bit	1.xxx	C, W, T (,R) ¹	
 16	Channel 1 value	Disabling function 1	1 byte	5.xxx	C, T, (,R) ¹	
 16	Channel 1 value	Disabling function 1	2 bytes	9.001	C, T, (,R) ¹	
 17	Switching	Disabling function 2	1 bit	1.xxx	C, W, T (,R) ¹	
 17	Short-time operation	Disabling function 2	1 bit	1.007	C, T, (,R) ¹	
 17	Value	Disabling function 2	2 byte	5.xxx	C, W, T (,R) ¹	
 17	Value	Disabling function 2	1 byte	7.xxx	C, W, T (,R) ¹	
 17	Temperature value	Disabling function 2	2 bytes	9.001	C, W, T (,R) ¹	
 17	Brightness value	Disabling function 2	2 bytes	9.004	C, W, T (,R) ¹	
 17	Scene extension	Disabling function 2	1 byte	18.001	C, T, (,R) ¹	
 17	Channel 1 switching	Disabling function 2	1 bit	1.xxx	C, W, T (,R) ¹	
 17	Channel 1 value	Disabling function 2	1 byte	5.xxx	C, T, (,R) ¹	
 17	Channel 1 value	Disabling function 2	2 bytes	9.001	C, T, (,R) ¹	
 34	Long-time operation	Disabling function 1	1 bit	1.008	C, W, T (,R) ¹	
 34	Dimming	Disabling function 1	4 bit	3.007	C, W, T (,R) ¹	
 34	Channel 2 switching	Disabling function 1	1 bit	1.xxx	C, W, T (,R) ¹	
 34	Channel 2 value	Disabling function 1	1 byte	5.xxx	C, T, (,R) ¹	
 34	Channel 2 value	Disabling function 1	2 bytes	9.001	C, T, (,R) ¹	
 35	Long-time operation	Disabling function 2	1 bit	1.008	C, W, T (,R) ¹	
 35	Dimming	Disabling function 2	4 bit	3.007	C, W, T (,R) ¹	
 35	Channel 2 switching	Disabling function 2	1 bit	1.xxx	C, W, T (,R) ¹	
 35	Channel 2 value	Disabling function 2	1 byte	5.xxx	C, T, (,R) ¹	
 35	Channel 2 value	Disabling function 2	2 bytes	9.001	C, T, (,R) ¹	
 54	Disabling	Key disabling	1 bit	1.001	C, W, (,R) ¹	

¹: Communication objects can be read out (set L-flag).

Operation-LED:						
<input type="checkbox"/>	52	Operation-LED	Switching	1 bit	1.001	C, W, (,R) ¹
Alarm message:						
Object	Function	Name	Type	DP-ID	Flag	
<input type="checkbox"/>	56	Switching	Alarm signalling	1 bit	1.xxx	C, W, (,R) ¹
<input type="checkbox"/>	57	Switching	Alarm signalling acknowledge	1 bit	1.xxx	C, T, (,R) ¹
Controller extension unit:						
Object	Function	Name	Type	DP-ID	Flag	
<input type="checkbox"/>	58	Operating mode switch-over	Controller extension unit	1 byte	20.102	C, W, T (,R) ¹
<input type="checkbox"/>	59	Forced operating mode switch-over	Controller extension unit	1 byte	20.102	C, W, T (,R) ¹
<input type="checkbox"/>	60	Presence key	Controller extension unit	1 bit	1.001	C, W, T (,R) ¹
<input type="checkbox"/>	61	Reference value shift output	Controller extension unit	1 byte	6.010	C, T, (,R) ¹
<input type="checkbox"/>	62	Reference value shift input	Controller extension unit	1 byte	6.010	C, W, (,R) ¹
<input type="checkbox"/>	63	Controller status	Controller extension unit	1 byte	n. def.	C, W, (,R) ¹
<input type="checkbox"/>	64	Measured room temperature	Room temperature measurement	2 bytes	9.001	C, T, (,R) ¹
<input type="checkbox"/>	65	External temperature sensor	Room temperature measurement	2 bytes	9.001	C, W, T (,R) ¹
Scene control:						
Object	Function	Name	Type	DP-ID	Flag	
<input type="checkbox"/>	66	Switching	Scene output 1 ⁵	1 bit	1.001	C, W, T (,R) ¹
<input type="checkbox"/>	66	Value	Scene output 1 ⁵	1 byte	5.xxx	C, W, T (,R) ¹
<input type="checkbox"/>	66	Value	Scene output 1 ⁵	1 byte	5.001	C, W, T (,R) ¹
<input type="checkbox"/>	74	Extension input	Scenes	1 byte	18.001	C, W, (,R) ¹
¹ : Communication objects can be read out (set L-flag). ⁵ : Scene outputs 2 ... 8 see scene output 1 with object number shifted accordingly (66 + scene output number - 1).						

Application:	Universal 4-gang 10A501 Universal 3-gang 10A301 Universal 2-gang 10A201 Universal 1-gang 10A001		
Executable from mask version:	7.5		
Number of addresses (max):	120	dynamic table management	YES NO
Number of assignments (max):	120	maximum table length	240
Communication objects:	47 4-gang 41 3-gang 35 2-gang 29 1-gang (maximum object number 50, gaps in between)		

Rocker 1...4 2





















Object ³	Function	Name:	Type	DP-ID	Flag
0	Switching	Rocker 1	1 bit	1.xxx	C, W, T (,R) ¹
0	Status-LED top	Rocker 1	1 bit	1.xxx	C, W, (,R) ¹
0	Short-time operation	Rocker 1	1 bit	1.007	C, T, (,R) ¹
0	Value	Rocker 1	1 byte	5.xxx	C, W, T (,R) ¹
0	Value	Rocker 1	2 bytes	7.xxx	C, W, T (,R) ¹
0	Temperature value	Rocker 1	2 bytes	9.001	C, W, T (,R) ¹
0	Brightness value	Rocker 1	2 bytes	9.004	C, W, T (,R) ¹
0	Scene extension unit	Rocker 1	1 byte	18.001	C, T, (,R) ¹
0	Channel 1 switching	Rocker 1	1 bit	1.xxx	C, W, T (,R) ¹
0	Channel 1 value	Rocker 1	1 byte	5.xxx	C, T, (,R) ¹
0	Channel 1 value	Rocker 1	2 bytes	9.001	C, T, (,R) ¹
1	Switching	Rocker 1 full-surface actuation	1 bit	1.xxx	C, W, T (,R) ¹
1	Channel 1 value	Rocker 1 full-surface actuation	1 byte	18.001	C, T, (,R) ¹
1	Status-LED bottom	Rocker 1	1 bit	1.xxx	C, W, (,R) ¹
10	Dimming	Rocker 1	4 bit	3.007	C, W, T (,R) ¹
10	Long-time operation	Rocker 1	1 bit	1.008	C, W, T (,R) ¹
10	Channel 2 switching	Rocker 1	1 bit	1.xxx	C, W, T (,R) ¹
10	Channel 2 value	Rocker 1	1 byte	5.xxx	C, T, (,R) ¹
10	Channel 2 value	Rocker 1	2 bytes	9.001	C, T, (,R) ¹
20	Status-LED top	Rocker 1	1 bit	1.xxx	C, W, (,R) ¹
20	Status-LED top	Rocker 1	1 byte	20.102	C, W, (,R) ¹
20	Status-LED top	Rocker 1	1 byte	5.xxx	C, W, (,R) ¹
20	Status-LED top	Rocker 1	1 byte	6.xxx	C, W, (,R) ¹
21	Status-LED bottom	Rocker 1	1 bit	1.xxx	C, W, (,R) ¹
21	Status-LED bottom	Rocker 1	1 byte	20.102	C, W, (,R) ¹
21	Status-LED bottom	Rocker 1	1 byte	5.xxx	C, W, (,R) ¹
21	Status-LED bottom	Rocker 1	1 byte	6.xxx	C, W, (,R) ¹

¹: Communication objects can be read out (set L-flag).































²: The number of rockers or keys depends on the pushbutton sensor variant programmed. Mixed operation of rocker or key functions in a pushbutton sensor is possible.

³: The objects have been described for rocker rocker 1 as an example. The object descriptions apply analogously to 2 ... max. 4 rockers with the corresponding object number.

Key 1...8²:

Object ⁴	Function	Name ⁴	Type	DP-ID	Flag
 0	Switching	Key 1	1 bit	1.xxx	C, W, T (,R) ¹
 0	Status-LED	Key 1	1 bit	1.xxx	C, W, (,R) ¹
 0	Short-time operation	Key 1	1 bit	1.007	C, T, (,R) ¹
 0	Value	Key 1	2 bytes	5.xxx	C, W, T (,R) ¹
 0	Value	Key 1	1 byte	7.xxx	C, W, T (,R) ¹
 0	Temperature value	Key 1	2 bytes	9.001	C, W, T (,R) ¹
 0	Brightness value	Key 1	2 bytes	9.004	C, W, T (,R) ¹
 0	Scene extension unit	Key 1	1 byte	18.001	C, T, (,R) ¹
 0	Channel 1 switching	Key 1	1 bit	1.xxx	C, W, T (,R) ¹
 0	Channel 1 value	Key 1	1 byte	5.xxx	C, T, (,R) ¹
 0	Channel 1 value	Key 1	2 bytes	9.001	C, T, (,R) ¹
 10	Dimming	Key 1	4 bit	3.007	C, W, T (,R) ¹
 10	Long-time operation	Key 1	1 bit	1.008	C, W, T (,R) ¹
 10	Channel 2 switching	Key 1	1 bit	1.xxx	C, W, T (,R) ¹
 10	Channel 2 value	Key 1	1 byte	5.xxx	C, T, (,R) ¹
 10	Channel 2 value	Key 1	2 bytes	9.001	C, T, (,R) ¹
 20	Status-LED	Key 1	1 bit	1.xxx	C, W, (,R) ¹
 20	Status-LED	Key 1	1 byte	20.102	C, W, (,R) ¹
 20	Status-LED	Key 1	1 byte	5.xxx	C, W, (,R) ¹
 20	Status-LED	Key 1	1 byte	6.xxx	C, W, (,R) ¹















1: Communication objects can be read out (set L-flag).
2: The number of rockers or keys depends on the pushbutton sensor variant programmed. Mixed operation of rocker or key functions in a pushbutton sensor is possible.
4: The objects have been described for key 1 as an example. The object descriptions apply analogously to 2 ... max. 4 keys with the corresponding object number.

Disabling functions:						
Object	Function	Name	Type	DP-ID	Flag	
	8 Switching	Disabling function 1	1 bit	1.xxx	C, W, T (,R) ¹	
	8 Short-time operation	Disabling function 1	1 bit	1.007	C, T, (,R) ¹	
	8 Value	Disabling function 1	1 byte	5.xxx	C, W, T (,R) ¹	
	8 Value	Disabling function 1	2 bytes	7.xxx	C, W, T (,R) ¹	
	8 Temperature value	Disabling function 1	2 bytes	9.001	C, W, T (,R) ¹	
	8 Brightness value	Disabling function 1	2 bytes	9.004	C, W, T (,R) ¹	
	8 Scene extension unit	Disabling function 1	1 byte	18.001	C, T, (,R) ¹	
	8 Channel 1 switching	Disabling function 1	1 bit	1.xxx	C, W, T (,R) ¹	
	8 Channel 1 value	Disabling function 1	1 byte	5.xxx	C, T, (,R) ¹	
	8 Channel 1 value	Disabling function 1	2 bytes	9.001	C, T, (,R) ¹	
	9 Switching	Disabling function 2	1 bit	1.xxx	C, W, T (,R) ¹	
	9 Short-time operation	Disabling function 2	1 bit	1.007	C, T, (,R) ¹	
	9 Value	Disabling function 2	2 bytes	5.xxx	C, W, T (,R) ¹	
	9 Value	Disabling function 2	1 byte	7.xxx	C, W, T (,R) ¹	
	9 Temperature value	Disabling function 2	2 bytes	9.001	C, W, T (,R) ¹	
	9 Brightness value	Disabling function 2	2 bytes	9.004	C, W, T (,R) ¹	
	9 Scene extension unit	Disabling function 2	1 byte	18.001	C, T, (,R) ¹	
	9 Channel 1 switching	Disabling function 2	1 bit	1.xxx	C, W, T (,R) ¹	
	9 Channel 1 value	Disabling function 2	1 byte	5.xxx	C, T, (,R) ¹	
	9 Channel 1 value	Disabling function 2	2 bytes	9.001	C, T, (,R) ¹	
	18 Long-time operation	Disabling function 1	1 bit	1.008	C, W, T (,R) ¹	
	18 Dimming	Disabling function 1	4 bit	3.007	C, W, T (,R) ¹	
	18 Channel 2 switching	Disabling function 1	1 bit	1.xxx	C, W, T (,R) ¹	
	18 Channel 2 value	Disabling function 1	1 byte	5.xxx	C, T, (,R) ¹	
	18 Channel 2 value	Disabling function 1	2 bytes	9.001	C, T, (,R) ¹	
	19 Long-time operation	Disabling function 2	1 bit	1.008	C, W, T (,R) ¹	
	19 Dimming	Disabling function 2	4 bit	3.007	C, W, T (,R) ¹	
	19 Channel 2 switching	Disabling function 2	1 bit	1.xxx	C, W, T (,R) ¹	
	19 Channel 2 value	Disabling function 2	1 byte	5.xxx	C, T, (,R) ¹	
	19 Channel 2 value	Disabling function 2	2 bytes	9.001	C, T, (,R) ¹	
	30 Disabling	Key disabling	1 bit	1.001	C, W, (,R) ¹	







¹: Communication objects can be read out (set L-flag).

Operation-LED:					
<input type="checkbox"/>	28	Operation-LED	Switching	1 bit	1.001 C, W, (,R) ¹
Alarm message:					
Object	Function	Name	Type	DP-ID	Flag
<input type="checkbox"/>	32	Switching	Alarm signalling	1 bit	1.xxx C, W, (,R) ¹
<input type="checkbox"/>	33	Switching	Alarm signalling acknowledge	1 bit	1.xxx C, T, (,R) ¹
Controller extension unit:					
Object	Function	Name	Type	DP-ID	Flag
<input type="checkbox"/>	34	Operating mode switch-over	Controller extension unit	1 byte	20.102 C, W, T (,R) ¹
<input type="checkbox"/>	35	Forced operating mode switch-over	Controller extension unit	1 byte	20.102 C, W, T (,R) ¹
<input type="checkbox"/>	36	Presence key	Controller extension unit	1 bit	1.001 C, W, T (,R) ¹
<input type="checkbox"/>	37	Reference value shift output	Controller extension unit	1 byte	6.010 C, T, (,R) ¹
<input type="checkbox"/>	38	Reference value shift input	Controller extension unit	1 byte	6.010 C, W, (,R) ¹
<input type="checkbox"/>	39	Controller status	Controller extension unit	1 byte	undefined C, W, (,R) ¹
Scene control:					
Object	Function	Name	Type	DP-ID	Flag
<input type="checkbox"/>	42	Switching	Scene output 1 ⁵	1 bit	1.001 C, W, T (,R) ¹
<input type="checkbox"/>	42	Value	Scene output 1 ⁵	1 byte	5.xxx C, W, T (,R) ¹
<input type="checkbox"/>	42	Value	Scene output 1 ⁵	1 byte	5.001 C, W, T (,R) ¹
<input type="checkbox"/>	50	Extension input	Scenes	1 byte	18.001 C, W, (,R) ¹
¹ : Communication objects can be read out (set L-flag). ⁵ : Scene outputs 2 ... 8 see scene output 1 with object number shifted accordingly (66 + scene output number - 1)					

Object description for the rocker function

	0, 1	Switching	1-bit object for the transmission of switching telegrams (ON, OFF).
	0	Short-time operation	1-bit object for the transmission of telegrams with which a blind or shutter drive motor can be stopped or with which the shutter slats can be adjusted by short-time operation.
	0, 1	Scene extension unit	1-byte object for recalling or for storing one of 64 scenes max. from a scene pushbutton sensor.
	0	Brightness value	2-byte object for the transmission of a brightness level value from 0 lux to 1500. If the variation of the value is enabled, the object can transmit telegrams cyclically after a long press with which the value can be reduced or increased by 50 lux.
	0	Temperature value	2-byte object for the transmission of a temperature value from 0 °C to 40 °C. If the variation of the value is enabled, the object can transmit telegrams cyclically after a long press with which the value can be reduced or increased by 1 °K.
	0	Value	1-byte object or 2-byte object for the transmission of values from 0 to 255 (corresponding to values from 0 % to 100 %) or from 0 to 65535. If the variation of the value is enabled, the object can transmit telegrams cyclically after a long press with which the value can be reduced or increased by a presettable amount.
	0	Channel 1 switching	1-bit object for the transmission of switching telegrams, if the 2-channel control is activated.
	0	Channel 1 value	1-byte object or 2-byte object for the transmission of value telegrams, if the 2-channel control is activated.
	0, 20, 36	Status-LED top	1-bit object or 1-byte object for controlling the status LED.
	1, 21, 37	Status LED bottom	1-bit object or 1-byte object for controlling the status LED.
	10, 18	Dimming	4-bit object for the transmission of relative dimming telegrams.
	10, 18	Long-time operation	1-bit object for the transmission of telegrams with which a blind or shutter drive motor can be moved up or down.
	10, 18	Channel 2 switching	1-bit object for the transmission of switching telegrams, if the 2-channel control is activated.
	10, 18	Channel 2 value	1-byte object or 2-byte object for the transmission of value telegrams, if the 2-channel control is activated.

Object description for the rocker function

	0	Switching	1-bit object for transmission of switching telegrams (ON, OFF).
	0	Short-time operation	1-bit object for the transmission of telegrams with which a blind or shutter drive motor can be stopped or with which the shutter slats can be adjusted by short-time operation.
	0	Scene extension	1-byte object enabling the pushbutton sensor to transmit a telegram to a scene pushbutton sensor for recalling or for storing one of max. 64 scenes.
	0	Brightness value	2-byte object for the transmission of a brightness level value from 0 lux to 1500. If the variation of the value is enabled, the object can transmit telegrams cyclically after a long press with which the value can be reduced or increased by 50 lux.
	0	Temperature value	2-byte object for the transmission of a temperature value from 0 °C to 40 °C. If the variation of the value is enabled, the object can transmit telegrams cyclically after a long press with which the value can be reduced or increased by 1 °K.
	0	Value	1-byte object or 2-byte object for the transmission of values from 0 to 255 (corresponding to values from 0 % to 100 %) or from 0 to 65535. If the variation of the value is enabled, the object can transmit telegrams cyclically after a long press with which the value can be reduced or increased by a presettable amount.

	0	Channel 1 switching	1-bit object for the transmission of switching telegrams, if the 2-channel control is activated.
	0	Channel 1 value	1-byte object or 2-byte object for the transmission of value telegrams, if the 2-channel control is activated.
	0, 20, 36	Status LED	1-bit object or 1-byte object for controlling the status LED.
	10, 18	dimming	4-bit object for the transmission of relative dimming telegrams.
	10, 18	Long-time operation	1-bit object for the transmission of telegrams with which a blind or shutter drive motor can be moved up or down.
	10, 18	Channel 2 switching	1-bit object for the transmission of switching telegrams, if the 2-channel control is activated.
	10, 18	Channel 2 value	1-byte object or 2-byte object for the transmission of value telegrams, if the 2-channel control is activated.

Object description for the disabling function

	8, 9, 16, 17	Switching	1-bit object for the transmission of switching telegrams (ON, OFF).
	8, 9, 16, 17	Short-time operation	1-bit object for the transmission of telegrams with which a blind or shutter drive motor can be stopped or with which the shutter slats can be adjusted by short-time operation.
	8, 9, 16, 17	Scene extension	1-byte object enabling the pushbutton sensor to transmit a telegram to a scene pushbutton sensor for recalling or for storing one of max. 64 scenes.
	8, 9, 16, 17	Brightness value	2-byte object for the transmission of a brightness level value from 0 lux to 1500. If the variation of the value is enabled, the object can transmit cyclical telegrams after a long press with which the value can be reduced or increased by 50 lux.
	8, 9, 16, 17	Temperature value	2-byte object for the transmission of a temperature value from 0 °C to 40 °C. If the variation of the value is enabled, the object can transmit telegrams cyclically after a long press with which the value can be reduced or increased by 1 °K.
	8, 9, 16, 17	Value	1-byte object or 2-byte object for the transmission of values from 0 to 255 (corresponding to values from 0 % to 100 %) or from 0 to 65535. If the variation of the value is enabled, the object can transmit telegrams cyclically after a long press with which the value can be reduced or increased by a presettable amount.
	8, 9, 16, 17	Channel 1 switching	1-bit object for the transmission of switching telegrams, if the 2-channel control is activated.
	8, 9, 16, 17	Channel 1 value	1-byte object or 2-byte object for the transmission of value telegrams, if the 2-channel control is activated.
	18, 19, 34, 35	dimming	4-bit object for the transmission of relative dimming telegrams.
	18, 19, 34, 35	Long-time operation	1-bit object for the transmission of telegrams with which a blind or shutter drive motor can be moved up or down.
	18, 19, 34, 35	Channel 2 switching	1-bit object for the transmission of switching telegrams, if the 2-channel control is activated.
	18, 19, 34, 35	Channel 2 value	1-byte object or 2-byte object for the transmission of value telegrams, if the 2-channel control is activated.
	30, 54	Disable	1-bit object with which the pushbutton sensor can be disabled and re-enabled (polarity can be parameterized).

Object description for operation LED

	28, 52	Switching	1-bit object for switching the operation LED on or off ("1" = on; "0" = off).
--	--------	-----------	---

Object description for alarm messages

	32, 56	Switching	1-bit object for the reception of an alarm message (polarity can be parameterized).
	33, 57	Switching	1-bit object for transmitting the alarm message acknowledgement (polarity can be parameterized)

Object description for controller extension

□←	58	Operating mode switch-over	1-byte object for switching over a room temperature controller between the comfort, standby, night and frost / heat protection operating modes
□→	59	Forced operating mode switch-over	1-byte object for switching over a room temperature controller between the comfort, standby, night and frost / heat protection operating modes
□→	60	Presence key	1-bit object for switching over the presence status of a room temperature controller (polarity can be parameterized)
□→	61	Setpoint shift out	1-byte object for presetting a basic setpoint shift for a controller. $x \leq 0 \leq y$ (0 = no active shifting); integers Value object 62 + 1 (increase step value) Value object 62 + 1 (decrease step value) The possible range of values (x to y) is fixed by the setpoint adjusting range to the 'upper limit' or to the 'lower limit' (parameterizable) in combination with the step value on the room temperature controller.
□→	62	Setpoint shift in	1-byte object used by the extension for receiving the current setpoint shift of the room temperature controller $x \leq 0 \leq y$ (0 = no active shifting); integers The possible range of values (x to y) is fixed by the setpoint adjusting range to the 'upper limit' or to the 'lower limit' (parameterizable) in combination with the step value on the room temperature controller.
□→	63	Controller status	1-byte object used by the extension for receiving the current state of operation of the controller. Status LEDs that can be used to indicate a status independently of a key function can display one of the various information units which a grouped in this byte (bit-oriented evaluation).
□→	64	Measured room temperature	2-byte object for the transmission of the measured temperature. When evaluating the room temperature, the pushbutton sensor can optionally use only the internal sensor or also the value measured by an external sensor.
□→	65	External temperature sensor	2-byte object with which the pushbutton sensor can receive or scan the temperature value of an external sensor.

Object description for scene control

□←	42...50, 66...73	Switching	1-bit objects for controlling up to 8 actuator groups (ON, OFF).
□←	42...50, 66...73	Value	1-byte objects for controlling up to 8 actuator groups (0...255).
□←	50, 74	Extension input	1-byte object with which one of the eight internally stored scenes can be recalled or stored again.

Scope of functions

- Each control surface can either be used as a single rocker or as two independent keys.
- The control surfaces can be configured in such a way that they are arranged in horizontal or vertical direction
- Each rocker can be used for the functions 'switching', 'dimming', 'blind/shutter control', '1-byte value transmitter', '2-byte value transmitter' and 'scene extension'.
- Each key can be used for the functions 'switching', 'dimming', 'blind/shutter control', '1-byte value transmitter', '2-byte value transmitter', 'scene extension' and room temperature controller extension.
- 2-channel control: each rocker or each key can be set for controlling two independent channels. This means that only one key-press is enough to transmit up to 2 telegrams over the bus. The channels can be parameterized independent of one another for the functions 'Switching', 'Value transmitter (1 byte)' or 'Temperature value transmitter (2 bytes)' .
- As far as the rocker functions 'Dimming', 'Blind/shutter (operation concept "Long – Short or Short")' and '2-channel control' are concerned, a full-surface rocker actuation can be evaluated as well. With full-surface rocker actuation it is possible to send switching telegrams and scene recall requests over the bus independently of the programmed rocker function.
- The switching function permits the following settings: reaction after pressing and/or releasing, switching on and off and toggling.
- The dimming function permits the following settings: one- or two-surface actuation, times for short and long actuation, dimming in different steps, telegram repetition on long press, transmission of stop telegram after end of press.
- The blind/shutter control permits the following settings: one- or two-surface actuation, four different operation concepts with times for short and long press and slat adjustment.
- The 1-byte and 2-byte value transmitter function permits the following settings: selection of the value range (0 ... 100 %, 0 ... 255, 0 ... 65535, 0 ... 1500 lux, 0 ... 40 °C), value on key-press, value change on sustained key-press with different step sizes.
- The scene control permits the following settings: Internal storage of eight scenes with eight output channels, recall of internal scenes by means of a presettable scene number, selection of object types for the output channels; for each scene, the storage of the individual output values and the transmission of the output values can be permitted or inhibited; the individual channels can be delayed during scene recall; as scene extension, 64 scenes can be recalled and stored.
- The controller extension function permits the following settings: operating mode switch-over with normal and high priority, defined selection of an operating mode, change between different operating modes, change of presence status, setpoint shift.
- Each control surface has two status LEDs in vertical arrangement.
- When a status LED is internally connected with the rocker or the key, it can signal a key-press or the current status of a communication object. The status can also be indicated in inverted form.
- When a status LED is not dependent on the rocker or key, it can be permanently on or off, indicate the status of an independent communication object, the operating state of a room temperature controller or the result of a comparison between signed or unsigned 1-byte values.
- The operation LED can be permanently on or off or alternatively be switched via a communication object.
- The rockers or keys can be disabled via a 1-bit object. The following settings are possible: polarity of the disabling object, behaviour at the beginning and at the end of disabling. During an active disable, all or some of the rockers / keys can have no function, can perform the function of a selected key or execute one of two presettable disabling functions.
- All LEDs of the pushbutton sensor can flash simultaneously in the event of an alarm. The following settings are possible: Value of alarm signalling object for the states alarm / no alarm, alarm acknowledge by actuation of a key, transmission of the acknowledge signal to other devices.

Contents

Contents	Page
1 General settings	22
1.1 Rocker / key selection	22
1.2 Key layout	23
1.3 Operation LED	24
1.4 Transmit delay	24
2 "Switching" function	25
3 "Dimming" function	25
3.1 Single-surface and double-surface actuation	25
3.2 Advanced parameters	25
3.3 Full-surface actuation	26
4 "Shutter" function	26
4.1 Single-surface and double-surface actuation	26
4.2 Operation concepts	27
4.2.1 Operation concept "step-move-step".	27
4.2.2 Operation concept "long – short"	28
4.2.3 Operation concept "short – long".	28
4.2.4 Operation concept "long – short or short"	29
4.3 Full-surface actuation	29
5 "1-byte value transmitter" and "2-byte value transmitter" function	30
5.1 Value ranges	30
5.2 Variation by means of long key-press	30
5.3 Value variation examples	31
6 "Scene extension" function	32
7 2-channel operation	33
7.1 Operation concept channel 1 or channel 2	33
7.2 Operation concept channel 1 and channel 2	34
7.3 Full-surface actuation	34
8 Status LED	35
8.1.1 Status LED function "always OFF" or "always ON"	36
8.1.2 Function of the status LED as "actuation indicator / telegram acknowledge"	36
8.1.3 Function of the status LED as "status indicator"	36
8.1.4 Function of the status LED as "operating mode indicator (KNX controller)"	36
8.1.5 Function of the status LED as "controller status indicator"	37
8.1.6 Function of the status LED as "comparator"	38
9 Scene control	39
9.1 Scene definition and scene recall	39
9.2 Storing scenes	41
10 Key disabling	42
11 Controller extension:	46
11.1 Connection to room temperature controller	46
11.2 Key functions for "Mode of operation switch-over" and "Forced mode of operation switch-over"	47
11.3 Key function "Presence key"	48
11.4 Key function "Setpoint shift"	48
12 Room temperature measurement (only 8-gang)	50
13 Alarm signalling	52

Functional description

1 General settings

The pushbutton sensor Universal TSM is equipped with square control surfaces which can be used independently of one another as a rocker with two opposite actuation points or as two keys with one actuation point respectively. The number of control rockers depends on the pushbutton sensor variant used.

Depending on the function of the rocker / key, the two red LEDs beside each rocker may be internally connected with the control function. They may, however, also be used for signalling completely independent functions or be permanently on or off.

The blue operation LED can also signal the value of an object of its own or be permanently on or off. Besides functions that can be programmed with the application software, the operation LED also indicates that the pushbutton sensor is in the programming mode for commissioning or diagnosis purposes.

Moreover, the pushbutton sensor Universal TSM has functions which are not immediately linked with the rockers or keys and which must therefore be additionally enabled by the corresponding parameters. These functions are: controller extension, room temperature measurement (only 8-gang version), key function disable, internal scenes and the display of alarm signals.

Notes on this product information:

Some chapters of the functional description makes use of screenshots of the parameter windows. These screenshots are intended to illustrate the parameter settings described in detail. The screenshots were made in the ETS3. In the ETS2, the parameters are listed in the same place. Only the graphic display of the parameter window is different from that in the ETS3.

1.1 Rocker / key selection

The choice between rocker and key control is made on the parameter page "**Rocker/key selection**". The other parameter pages and the communication objects of the rockers or keys are adapted according to the settings selected on this tab.

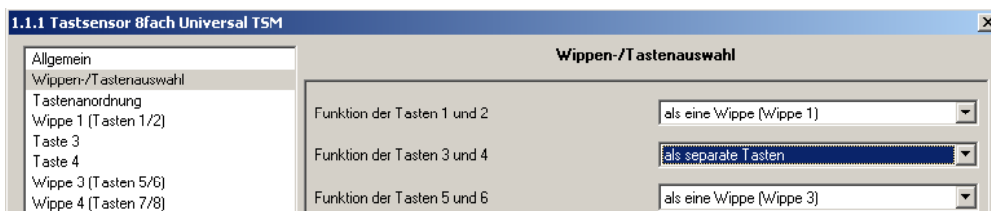

If a control surface is used as a rocker, both actuation points act in common on the communication objects assigned to the rocker. As a rule, a press on the two actuation points will then produce exactly the opposite reaction (e.g. switching: ON, OFF / shutter: UP - DOWN). The commands given when a key is pressed are generally independent of one another.

Depending on the basic function of a rocker, it is also possible with some settings to use a full-surface actuation with a separate function.

When a control surface is used as separate keys, the keys are parameterized independently of one another and can fulfil completely different functions (e.g. switching: TOGGLE – controller operating mode: comfort). In addition to the function selection in case of the rocker function, the key operation offers moreover the possibility of using the keys as an extension to a room temperature controller. A Full-surface actuation of the sensor in the key control mode is not possible.

Pressing several rockers or keys at the same time will be considered as a wrong operation. The special rocker function "Full-surface actuation" is an exception to the above rule. In this case, the programming of the rocker decides whether the operation is a wrong operation or not.

1.2 Key layout

On the parameter page "Key layout", the user can select separately for each key pair of a control surface how the keys are to be arranged on the surface, i.e. where the actuation points are located.

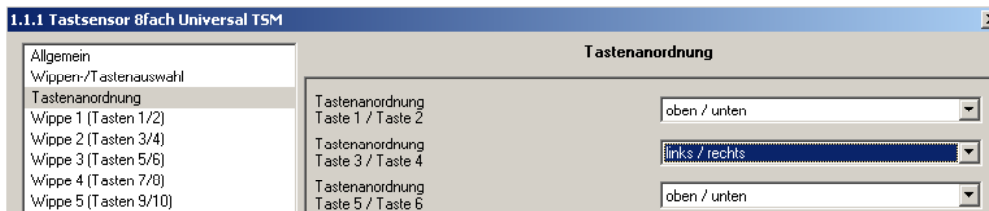

In the basic layout, both actuation points of a control surface are arranged vertically (top / bottom) (cf. Fig. 2). Figs. 2 and 3 are an example of the key layout in a 4-gang pushbutton sensor Universal.

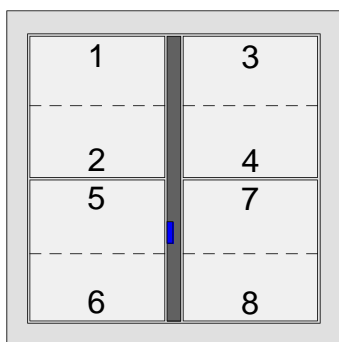

Fig. 2: Key layout "top / bottom"

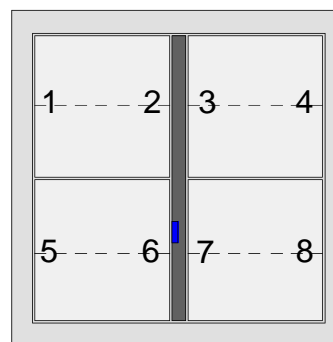

Fig. 3: Key layout "left / right"

It is also possible to program different key layouts in the same pushbutton sensor (cf. Fig. 4).

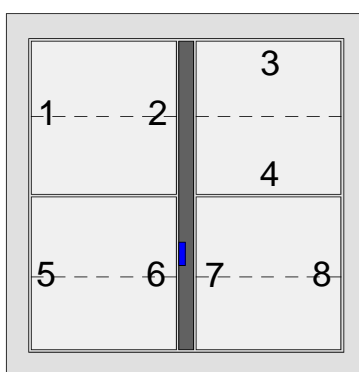

Fig. 4: Different key configurations in the same pushbutton sensor

The configuration can still be changed later on. Assigned group addresses or parameter settings remain unaffected by such changes.

1.3 Operation LED

The blue operation LED of the pushbutton sensor Universal TSM is used for different functions which are partly fixed internal default functions.

- In a non-programmed device (delivery state) or after downloading of a wrong application program, this LED flashes at a slow rate of 0.75 Hz.
- When the pushbutton sensor is switched over into the programming mode for commissioning or for diagnosis purposes, the LED flashes at a fast rate of about 8 Hz (cf. "Commissioning in the hardware description of this documentation).
- To confirm the detection of a full-surface press with the rocker function, the LED flashes with 8 Hz, too.

The application software permits selecting parameters for further functions of the LED:

- The LED can flash together with all other red status LEDs with a frequency of about 2 Hz, when the communication object for the alarm message is active.
- The LED can display the status of a separate communication object in inverted or non-inverted form.
- The LED can be switched on permanently to serve as orientation lighting.
- The LED can be permanently off.

If several of the above states occur at the same time, the priority is as follows:

1. Display of the programming mode. The programming mode is cancelled automatically after an actuation.
2. Display of a valid full-surface actuation with the rocker function.
3. Display of an alarm. The mode of resetting the alarm either automatically by a key-press or by the communication object must be specified in the parameters.
4. The status display for the separate communication object or the permanent states (on, off).

1.4 Transmit delay

After a reset (e.g. after loading of an application program or the physical address or after return of bus voltage), the pushbutton sensor (only 8-gang) can transmit telegrams automatically for the functions room temperature controller extension and room temperature measurement. In case of the controller extension, the pushbutton sensor attempts to retrieve values from the room temperature controller by means of read telegrams in order to update the object states. In case of the room temperature measurement, the pushbutton sensor transmits the current room temperature after a reset to the bus.

If there are still other devices in the bus which transmit telegrams immediately after a reset, it may be useful to activate the transmit delay for automatically transmitting objects on the "General" page in order to reduce the bus load.

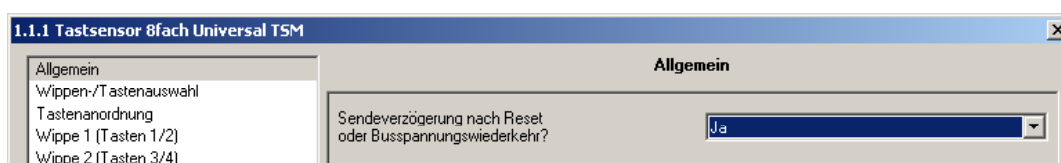

If the transmit delay is activated, the pushbutton sensor infers the value of its own delay from the device number in its physical address (physical address: area.line.device number). This value can be about 30 seconds maximum. Without setting a special delay, this principle prevents several pushbutton sensors Universal TSM from transmitting telegrams to the bus at the same time.

The transmit delay is not active for the rocker and key functions of the pushbutton sensor.

2 "Switching" function

For each rocker or each key with the function set to "switching" the ETS indicates a 1-bit communication object. The parameters of the rocker or key permit fixing the value this object is to adopt on pressing and / or on releasing. No distinction is made between a brief or long press.

The status LEDs can be parameterized independently as described in chapter "8. Status LED".

3 "Dimming" function

For each rocker or each key with the function set to "dimming" the ETS indicates a 1-bit and a 4-bit object. Generally, the pushbutton sensor sends a switching telegram after a brief press and a dimming telegram after a long press. In the standard parameterization, the pushbutton sensor transmits a telegram for stopping the dimming action after a long press. The time needed by the pushbutton sensor to detect an actuation as a long actuation is presettable in the parameters.

The status LEDs can be parameterized independently as described in chapter "8. Status LED".

3.1 Single-surface and double-surface actuation

In the rocker function, the device is preprogrammed for double-surface actuation. This means that the pushbutton sensor transmits a telegram for switching on after a brief press and a telegram for increasing the brightness after a long press on the upper actuation point. Similarly, the pushbutton sensor transmits a telegram for switching off after a brief press and a telegram for reducing the brightness after a long press on the lower actuation point.

In the separate keys function, the device is preprogrammed for single-surface actuation. In this mode, the pushbutton sensor transmits on each brief press ON and OFF telegrams in an alternating pattern ("TOGGLE"). After a long press, the pushbutton sensor transmits "brighter" and "darker" telegrams in an alternating pattern.

For the rocker and also for the key function, the command issued on pressing the key or rocker can basically be selected at the user's discretion.

If the actuator can be controlled from several sensors, a faultless single-surface actuation requires that the addressed actuator reports its switching state back to the 1-bit object of the key or rocker and that the 4-bit objects of the pushbutton sensors are interlinked. The pushbutton sensor would otherwise not be able to detect that the actuator has been addressed from another sensor, in which case it would have to be actuated twice during the next use in order to produce the desired reaction.

3.2 Advanced parameters

For the dimming function, the pushbutton sensor can be programmed with advanced parameters which are hidden in the standard view for greater clarity. If necessary, these advanced parameters can be activated and thus be made accessible.

The advanced parameters can be used to determine whether the pushbutton sensor is to cover the full adjusting range of the actuator with one dimming telegram continuously ("Increase brightness by 100 %", "Reduce brightness by 100 %") or whether the dimming range is to be divided into several small steps (50 %, 25 %, 12.5 %, 6 %, 3 %, 1.5 %).

In the continuous dimming mode (100%), the pushbutton sensor transmits a telegram only at the beginning of the long press to start the dimming process and generally a stop telegram after the end of the press. For dimming in small steps it may be useful if the pushbutton sensor repeats the dimming telegram in case of a sustained press for a presettable time (parameter "Telegram repetition"). The stop telegram after the end of the press is then not needed.

When the parameters are hidden ("Advanced parameters = deactivated"), the dimming range is set to 100 %, the stop telegram is activated and the telegram repetition is deactivated.

3.3 Full-surface actuation

When a rocker is used for dimming, the pushbutton sensor needs some time at the beginning of each actuation in order to distinguish between a short and a long actuation. When the full-surface actuation is enabled, the pushbutton sensor can make use of this time span to evaluate the otherwise invalid simultaneous actuation of both actuation points.

The pushbutton sensor detects a full-surface actuation of a rocker, if a control surface is depressed on all sides so that both actuation points of the rocker are actuated.

When the pushbutton sensor has detected a valid full-surface actuation, the operation LED flashes fast at a rate of about 8 Hz for the duration of such actuation. The full-surface actuation must have been detected before the first telegram has been transmitted by the dimming function (switching or dimming). If this is not so, even a full-surface actuation will be interpreted as a wrong operation and not be executed.

A full-surface actuation is independent. It has a communication object of its own and can optionally be used for switching (ON, OFF, TOGGLE – toggling of the object value) or for scene recall without or with storage function. In the last case, a full-surface actuation of less than a second causes a scene to be recalled. If the pushbutton sensor is to send the telegram for storing a scene, the full-surface actuation must be maintained for more than 5 seconds. If the full-surface actuation is ended between the first and the fifth second, the pushbutton sensor will not send any telegrams. If the status LEDs of the rocker as used as "actuation indicators", they will light up for 3 seconds during transmission of the storage telegram.

4 "Shutter" function

For each rocker or each key with the function set to "shutter" the ETS indicates the two 1-bit objects "short-time operation" and "long-time operation".

The status LEDs can be parameterized independently as described in chapter "8. Status LED".

4.1 Single-surface and double-surface actuation

As a rocker, the device is preprogrammed for double-surface actuation. This means that the pushbutton sensor transmits a telegram for an upward move after an actuation of the upper actuation point and a telegram for a downward move after an actuation of the lower actuation point.

In the separate keys function, the device is preprogrammed for single-surface actuation. In this case, the pushbutton sensor alternates between the directions of the long-time telegram (TOGGLE) on each long actuation of the sensor. Several short-time telegrams in succession have the same direction.

For the key function, the command issued on pressing the key can basically be selected at the user's discretion.

If the actuator can be controlled from several sensors, a faultless single-surface actuation requires that the long-time objects of the pushbutton sensors are interlinked. The pushbutton sensor would otherwise not be able to detect that the actuator has been addressed from another sensor, in which case it would have to be actuated twice during the next use in order to produce the desired reaction.

4.2 Operation concepts

For the control of blind, shutter, awning or similar drives, the pushbutton sensor supports four operation concepts in which the telegrams are transmitted in different time sequences. The pushbutton can therefore be used to control the most different drive configurations.

The different operation concepts are described in detail in the following chapters.

4.2.1 Operation concept "step-move-step".

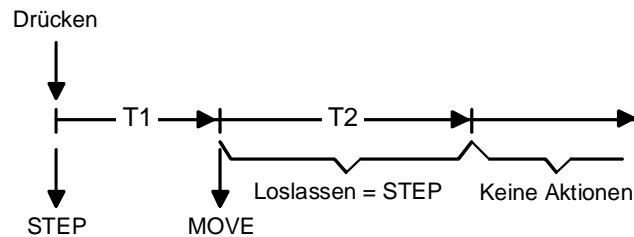

In the operation concept "step-move-step", the pushbutton sensor shows the following behaviour:

- Immediately on pressing the key, the pushbutton sensor transmits a short-time telegram. Pressing the key stops a running drive and starts time T1 ("time between short- and long-time command") If the key is released within T1, no further telegram will be transmitted. This STEP serves the purpose of stopping a continuous move.
The "time between short- and long-time command" in the pushbutton sensor should be selected shorter than the short-time operation of the actuator to prevent a jerky movement of the shutter.
- If the key is kept depressed longer than T1, the pushbutton sensor transmits a long-time telegram after the end of T1 for starting up the drive and time T2 ("slat adjustment time") is started.
- If the key is released within the slat adjustment time, the pushbutton sensor sends another short-time telegram. This function is used for adjusting the slats of a blind. The function permits stopping the slats in any position during their rotation.
The "slat adjustment time" should be chosen as required by the drive for a complete rotation of the slats. If the slat adjustment time is selected longer than the complete running time of the drive, a pushbutton function is possible as well. This means that the drive is active only as long as the key is depressed.
- If the key is kept depressed longer than T2, the pushbutton sensor transmits no further telegram. The drive remains on until the end position is reached.

4.2.2 Operation concept "long – short"

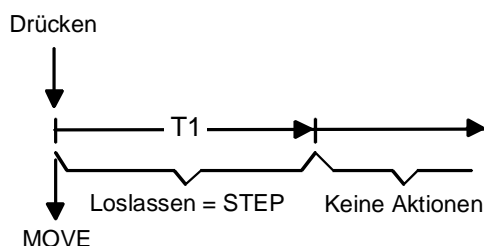

If the operation concept "long – short" is selected, the pushbutton sensor shows the following behaviour:

- Immediately on pressing the key, the pushbutton sensor transmits a long-time telegram. The drive begins to move and time T1 ("slat adjustment time") is started
- If the key is released within the slat adjustment time, the pushbutton sensor transmits a short-time telegram. This function is used for adjusting the slats of a blind. The function permits stopping the slats in any position during their rotation.
The "slat adjustment time" should be chosen as required by the drive for a complete rotation of the slats. If the slat adjustment time is selected longer than the complete running time of the drive, a pushbutton function is possible as well. This means that the drive is active only when the key is kept depressed.
- If the key is kept depressed longer than T1, the pushbutton sensor transmits no further telegram. The drive remains on until the end position is reached.

4.2.3 Operation concept "short – long".

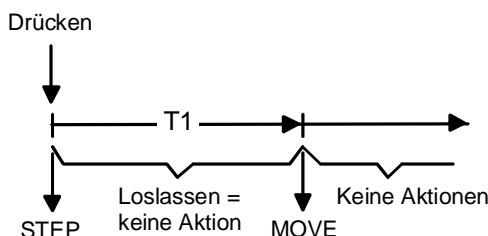

In the operation concept "short – long", the pushbutton sensor shows the following behaviour:

- Immediately on pressing the key, the pushbutton sensor transmits a short-time telegram. Pressing the key stops a running drive and starts time T1 ("time between short- and long-time command") If the key is released within T1, no further telegram will be transmitted. This STEP serves the purpose of stopping a continuous move.
The "time between short- and long-time command" in the pushbutton sensor should be selected shorter than the short-time operation of the actuator to prevent a jerky movement of the shutter.
- If the key is kept depressed longer than T1, the pushbutton sensor transmits a long-time telegram after the end of T1 for starting the drive.
- No further telegram is transmitted when the key is released. The drive remains on until the end position is reached.

4.2.4 Operation concept "long – short or short"

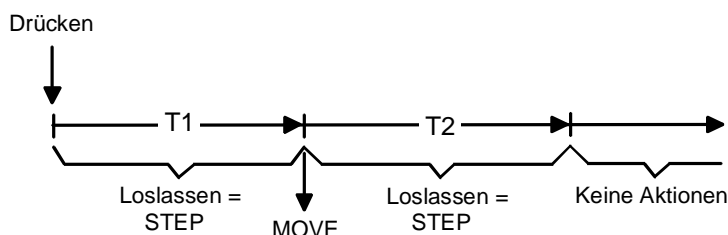

In the operation concept "long – short or short", the pushbutton sensor shows the following behaviour:

- Immediately on pressing the key, the pushbutton sensor starts time T1 ("time between short- and long-time command") and waits. If the key is released again before T1 has elapsed, the pushbutton sensor transmits a short-time telegram. This telegram can be used to stop a running drive. A stationary drive rotates the slats by one step.
The "time between short- and long-time command" in the pushbutton sensor should be selected shorter than the short-time operation of the actuator to prevent a jerky movement of the shutter.
- If the key is kept depressed after T1 has elapsed, the pushbutton sensor transmits a long-time telegram and starts time T2 ("slat adjustment time").
- If the key is released within T2, the pushbutton sensor sends another short-time telegram. This function is used for adjusting the slats of a blind. The function permits stopping the slats in any position during their rotation.
The "slat adjustment time" should be chosen as required by the drive for a complete rotation of the slats. If the slat adjustment time is selected longer than the complete running time of the drive, a pushbutton function is possible as well. This means that the drive is active only when the key is kept depressed.
- If the key is kept depressed longer than T2, the pushbutton sensor transmits no further telegram. The drive remains on until the end position is reached.

In this operation concept, the pushbutton sensor will not transmit a telegram immediately after depressing one side of the rocker. This principle permits detecting a full-surface actuation when the sensor is configured as a rocker.

4.3 Full-surface actuation

When a rocker is programmed for shutter operation and if the operation concept "long – short or short" is used, the pushbutton sensor needs some time at the beginning of each actuation in order to distinguish between a short and a long actuation. When the full-surface actuation is enabled, the pushbutton sensor can make use of this time span to evaluate the otherwise invalid simultaneous actuation of both actuation points.

The pushbutton sensor detects a full-surface actuation of a rocker, if a control surface is depressed on all sides so that both actuation points of the rocker are actuated.

When the pushbutton sensor has detected a valid full-surface actuation, the operation LED flashes fast at a rate of about 8 Hz for the duration of such actuation. The full-surface actuation must have been detected before the first telegram has been transmitted by the dimming function (STEP or MOVE). If this is not so, even a full-surface actuation will be interpreted as a wrong operation and not be executed.

A full-surface actuation is independent. It has a communication object of its own and can optionally be used for switching (ON, OFF, TOGGLE – toggling of the object value) or for scene recall without or with storage function. In the last case, a full-surface actuation of less than a second causes a scene to be recalled. If the pushbutton sensor is to send the telegram for storing a scene, the full-surface actuation must be maintained for more than 5 seconds. If the full-surface actuation is ended between the first and the fifth second, the pushbutton sensor will not send any telegrams. If the status LEDs of the rocker as used as "actuation indicators", they will light up for 3 seconds during transmission of the storage telegram.

5 "1-byte value transmitter" and "2-byte value transmitter " function

For each rocker or each key with the function set to "1-byte value transmitter" or "2-byte value transmitter" the ETS indicates a corresponding object.

On the press of a key, the parameterized value or the value last stored internally by a value change (see below) will be transmitted to the bus. In case of the rocker function, different values can be parameterized or varied for both actuation points.

The status LEDs can be parameterized independently as described in chapter "8. Status LED".

5.1 Value ranges

The "Functionality" parameter determines the value range used by the sensor.

As a 1-byte value transmitter, the pushbutton sensor can optionally transmit integers from 0 ... 255 or relative values within a range of 0 ... 100 % (e.g. as dimming value transmitter).

As a 2-byte value transmitter, the pushbutton sensor can optionally transmit integers from 0 ... 65535, temperature values within a range of 0 ... 40 °C or brightness values from 0 ... 1500 lux.

For each of these ranges, the value that can be transmitted to the bus for each actuation of a rocker or key is parameterizable.

5.2 Variation by means of long key-press

If the value variation feature has been enabled in the ETS, the key must be kept depressed for more than 5 seconds in order to vary the current value of the value transmitter. The value variation function continues to be active until the key is released again. In a value variation, the pushbutton sensor distinguishes the following options...

- The "Starting value for value variation" parameter defines the original starting value for the variation. Variation can begin from the value parameterized in the ETS, from the final value of the last variation cycle or from the current value of the communication object, with the last option not being available for the temperature and brightness value transmitter.
- The parameter "Direction of value variation" defines whether the values will always be increased ("upwards"), always reduced ("downwards") or alternately increased and reduced ("switch-over").
- For the value transmitters 0 ... 255, 0 ... 100 % and 0 ... 65535, the step size by which the current value is to be changed during the value variation can be specified. In case of the temperature and the brightness value transmitter, the step sizes (1 °C and 50 lux) are firm.
- The parameter "Time between two telegrams" can be used in conjunction with the step size to define the time required to cycle through the full respective value range. This value defines the time span between two value transmissions.
- When the pushbutton sensor detects during the value variation that the preset step size would result in the limits being exceeded with the next telegram, it adapts the step size once in such a way that the respective limit value is transmitted together with last telegram. Depending on the setting of the parameter "Value variation with overflow", the pushbutton sensor stops the variation at this instance or inserts a pause consisting of two steps and then continues the variation beginning with the other limit value.

Value range limits for the different value transmitters:

	Function	Lower limit	Upper limit
1-byte value transmitter	0 ... 255	0	255
	0 ... 100 %	0 % (value = "0")	100 % (value = "255")
2-byte value transmitter	0 ... 65535	0	65535
	temperature value	0 °C	40 °C
	brightness value	0 lux	1500 lux

Notes on value variation:

- During a value variation, the newly adjusted values are only in the volatile RAM memory of the pushbutton sensor. Therefore, the stored values are replaced by the preset values programmed in the ETS when a reset of the pushbutton sensor occurs (bus voltage failure or ETS programming).
- During a value variation, the status LED of the corresponding key is switched off irrespective of parameterization. The status LED will then light up for ca. 250 ms whenever a new value is transmitted.
- With the 1-byte value transmitter in the "Value transmitter 0...100 %" function, the step size of the variation will also be indicated in "%". If the starting value of the communication object is used, it may happen in this case during value variation that the value last received via the object must be rounded and adapted before a new value can be calculated on the basis of the step size and transmitted. Due to the computation procedure used, the new calculation of the value may be slightly inaccurate.

5.3 Value variation examples

Parameterization:

- 1-byte value transmitter (all other value transmitters identical)
- function = value transmitter 0...255
- ETS-projected value (0...255) = 227
- step size (1...10) = 5
- start on value variation = like parameterized value
- direction of value change = switch-over (alternatingly)
- time between two telegrams = 0.5 s

Example 1: value variation with overflow? = No

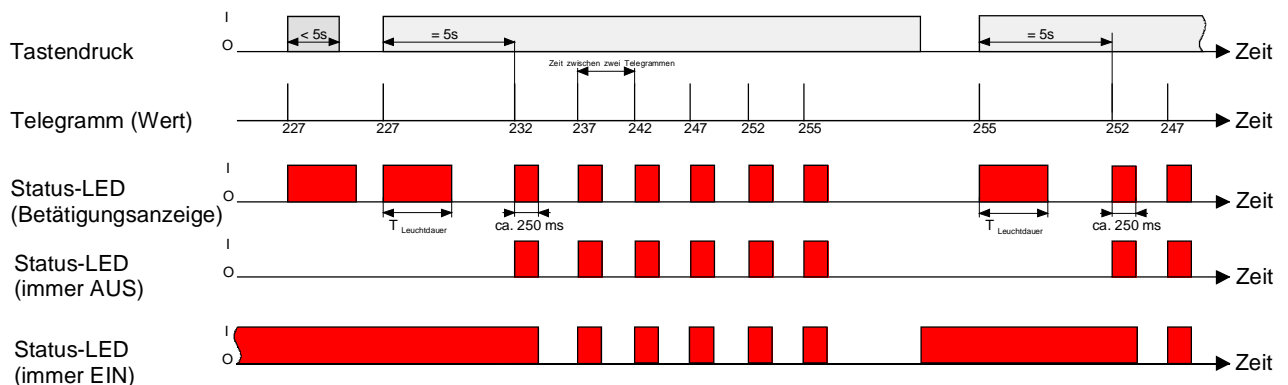

Example 2: value variation with overflow? = Yes

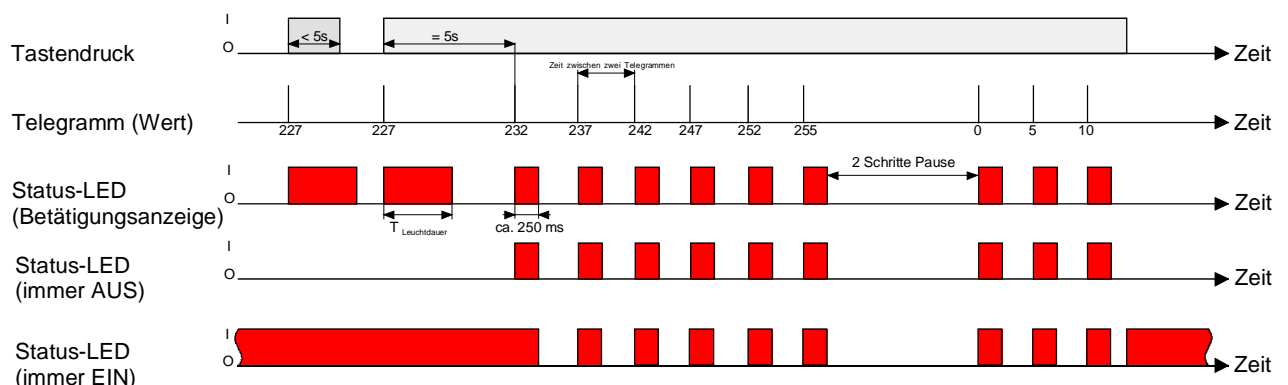

6 "Scene extension" function

For each rocker or each key with the function set to "scene extension" the ETS indicates the "Function" parameter which distinguishes between ...

- "Scene extension without storage function"
- "Scene extension with storage function"
- "Internal scene recall without storage function"
- "Internal scene recall with storage function"

In the scene extension function, the pushbutton sensor transmits a preset scene number (1...64) via a separate communication object to the bus after a key-press. This feature permits recalling scenes stored in other devices and also storing them, if the storage function is used.

The recall of an internal scene does not result in a telegram being transmitted on the bus. For this reason, the corresponding communication object is not existing. This function can rather be used to recall – and with the storage function also to store – the of 8 scenes max. stored internally in the pushbutton sensor Universal TSM.

In the setting "... without storage function", a key-press triggers the simple recall of a scene. If the status LED is parameterized as actuation indicator, it will be switched on for the parameterized ON-time. A long key-press has no further or additional effect.

In the setting "... with storage function", the pushbutton sensor monitors the length of the actuation. A key-press of less than a second results in a simple recall of the scene as mentioned above. If the status LED is parameterized as actuation indicator, it will be switched on for the parameterized ON-time.

After a key-press of more than five seconds, the pushbutton sensor generates a storage instruction. In the scene extension function, a storage telegram is in this case transmitted to the bus. If configured for the recall of an internal scene, the sensor will store the internal scene. The internal scene control module of the pushbutton sensor Universal TSM will then request the current scene values for the actuator groups used from the bus (cf. chapter "9 Scene control")

An actuation lasting between one and five seconds will be discarded as invalid.

The parameter "Scene number" specifies which of the maximum of 8 internal or 64 external scenes is to be used after a key-press. In case of the rocker function, two different scene numbers can be assigned.

The status LEDs can be parameterized independently as described in chapter "8. Status LED".

7 2-channel operation

In some situations it is desirable to control two different functions with a single key-press and to transmit different telegrams, i.e. to operate two function channels at a time. This is possible with the "2-channel operation" function.

For both channels, the parameters "Function channel 1" and "Function channel 2" can be used to determine the communication object types to be used. The following types are available for selection...

- Switching (1 bit)
- Value transmitter 0 ... 255 (1 byte)
- Value transmitter 0 ... 100 % (1 byte)
- Temperature value transmitter (2 bytes)

The object value the pushbutton sensor is to transmit on a key-press can be selected depending on the selected object type. The "Switching (1 bit)" type permits selecting whether an ON or an OFF telegram is to be transmitted or whether the object value is to be switched over (TOGGLE) and transmitted on the press of a key. The parameterization as "Value transmitter 0 ... 255 (1 byte)" or as "Value transmitter 0 ... 100 % (1 byte)" permits entering the object value freely within a range from 0 to 255 or from 0% to 100%. The "Temperature value transmitter (2 bytes)" permits selecting a temperature value between 0°C and 40°C.

In this case, the variation of the object value on a long key-press is not possible as the determination of the actuation length is needed for the adjustable operation concepts.

Unlike in the other rocker and key functions, the application software assigns the "Telegram acknowledge" function instead of the "Actuation indicator" function to the status LED. In this mode, the status LED lights up for about 250 ms with each telegram transmitted. As an alternative, the status LEDs can be parameterized independently as described in chapter "8. Status LED".

7.1 Operation concept channel 1 or channel 2

In this operation concept, exactly one telegram will be transmitted on each press of a key.

- A short press causes the pushbutton sensor to transmit the telegram for channel 1.
- A long press causes the pushbutton sensor to transmit the telegram for channel 2.

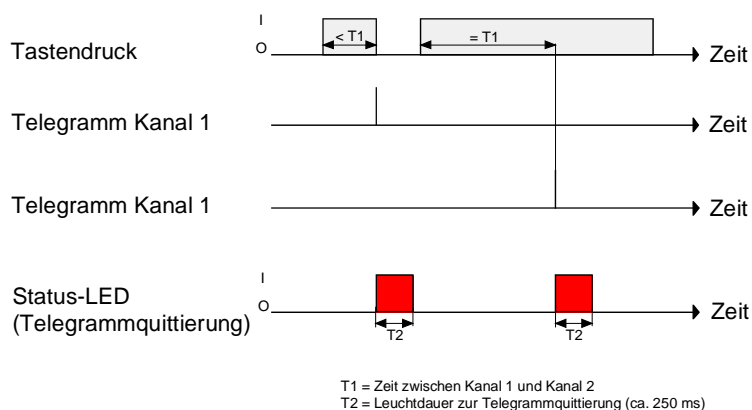

The time required for distinguishing between a short and a long actuation is defined by the parameter "Time between channel 1 and channel 2". If the key is pressed for less than the parameterized time, only the telegram to channel 1 is transmitted. If the length of the key-press exceeds the time between channel 1 and channel 2, only the telegram to channel 2 will be transmitted. This concept provides the transmission of only one channel. To indicate that a telegram has been transmitted, the status LED lights up for ca. 250 ms in the "Telegram acknowledge" mode.

In this operation concept, the pushbutton sensor will not transmit a telegram immediately after the rocker has been depressed. This principle permits detecting also a full-surface actuation. The settings that are possible with full-surface actuation are described below

7.2 Operation concept channel 1 and channel 2

With this operation concept, one or alternatively two telegrams can be transmitted on each key-press.

- A short press causes the pushbutton sensor to transmit the telegram for channel 1.
- A short press causes the pushbutton sensor to transmit first the telegram for channel 1 and then the telegram for channel 2.

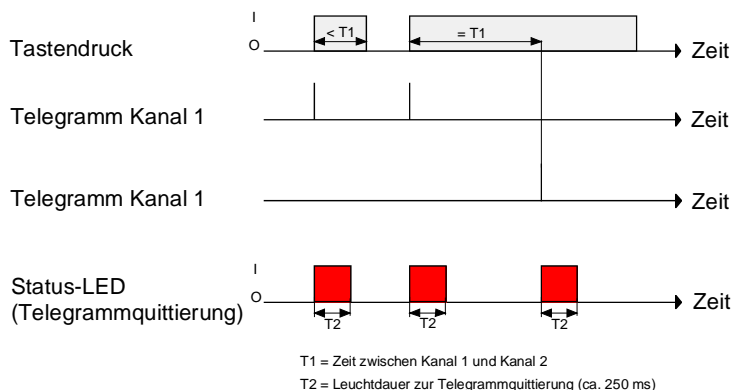

The time required for distinguishing between a short and a long actuation is defined by the parameter "Time between channel 1 and channel 2". In this operation concept, a key-press sends this telegram immediately to channel 1. If the key is held depressed for the parameterized time, the telegram for the second channel is transmitted as well. If the key is released before the time has elapsed, no further telegram will be transmitted. This operation concept, too, offers the parameterizable possibility of having the transmission of a telegram signalled by the status LED (setting "Telegram acknowledge").

7.3 Full-surface actuation

When a rocker is programmed for 2-channel operation and if the operation concept "channel 1 or channel 2" is used, the pushbutton sensor needs some time at the beginning of each actuation in order to distinguish between a short and a long actuation. When the full-surface actuation is enabled, the pushbutton sensor can make use of this time span to evaluate the otherwise invalid simultaneous actuation of both actuation points.

The pushbutton sensor detects a full-surface actuation of a rocker, if a control surface is depressed on all sides so that both actuation points of the rocker are actuated.

When the pushbutton sensor has detected a valid full-surface actuation, the operation LED flashes fast at a rate of about 8 Hz for the duration of such actuation. The full-surface actuation must have been detected before the first telegram has been transmitted by the 2-channel function. If this is not so, even a full-surface actuation will be interpreted as a wrong operation and not executed.

A full-surface actuation is independent. It has a communication object of its own and can optionally be used for switching (ON, OFF, TOGGLE – toggling of the object value) or for scene recall without or with storage function. In the last case, the full-surface actuation causes a scene to be recalled in less than a second. If the pushbutton sensor is to send the telegram for storing a scene, the full-surface actuation must be maintained for more than 5 seconds. If the full-surface actuation ends between the first and the fifth second, the pushbutton sensor will not send any telegrams. If the status LEDs of the rocker are used as "actuation indicators", they will light up for 3 seconds during transmission of the storage telegram.

8 Status LED

Each rocker has two status LEDs and each key has one status LED. Depending on the configuration of the rockers or keys, the functions available differ slightly.

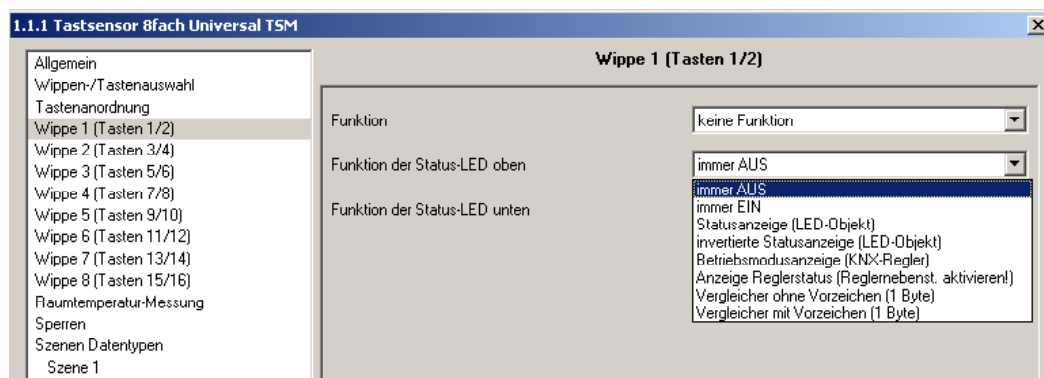

Every status LED can optionally indicate the following conditions...

- always OFF,
- always ON,
- status indicator (LED object),
- inverted status indicator (LED object),
- operating mode indication (KNX controller),
- controller status indicator (activate controller extension!),
- comparator without sign (1 byte),
- comparator with sign (1 byte).

These options are always available even if the rocker or key has no function assigned.

If a function has been assigned to the rocker or key, the ETS displays moreover the option...

- actuation indicator,

which is replaced in case of the "2-channel operation" function by

- telegram acknowledge.

If the rocker or the key is used for switching or dimming, the following options can be selected in addition...

- status indicator (switching object),
- inverted status indicator (switching object)

If a key is used for the operation of a controller extension, the following options can be selected in addition...

- indication of key function active / inactive (only with presence key),
- indication of setpoint value shift (only with setpoint shift)

Besides the functions that can be set separately for each status LED, all status LEDs are also used together with the operation LED for alarm messages. In case of an active alarm message, all LEDs of the pushbutton sensor flash simultaneously. After deactivation of the alarm message, all LEDs will immediately return to the state corresponding to their parameterization and communication objects.

8.1.1 Status LED function "always OFF" or "always ON"

The two status LED functions "always OFF" and "always ON" have no further settings and communication objects. In this setting, the status LED is either permanently ON or permanently OFF.

8.1.2 Function of the status LED as "actuation indicator / telegram acknowledge"

A status LED used as actuation indicator is switched on by the sensor each time the corresponding rocker or key is pressed. The parameter "On-time of the status LED as actuation indicator" on the parameter page "General" specifies for how long the LED is switched on. The status LED lights up when the rocker or key is pressed even if the telegram is transmitted by the sensor only when the key or rocker is being released.

In the "2-channel operation" function, the "actuation indicator" option is replaced by the "telegram acknowledge" option. In this case, the status LED lights up for about 250 ms during transmission of the telegrams for both channels

8.1.3 Function of the status LED as "status indicator"

Each status LED can indicate the status of a separate communication object independent of the rocker or key configuration. Additionally, the status LEDs can be linked in the rocker or key functions "switching" and "dimming" also with the object used for switching and thus signal the current switching state of the actuator group.

For both, the status indication of the LED object and the status indication of the switching object, it is also possible to indicate the inverted value.

After a reset of the pushbutton sensor Universal TSM or after programming with the ETS, the value of the LED object is always "OFF - 0".

8.1.4 Function of the status LED as "operating mode indicator (KNX controller)"

For switching over between different modes of operation, new room temperature controllers can make use of two communication objects of the 20.102 "HVAC-Mode" data type. One of these objects can switch over with normal priority between the modes of operation "comfort", "standby", "night", "frost/heat protection". The second object has a higher priority. It permits switching over between "automatic", "comfort", "standby", "night", "frost/heat protection". Automatic means in this case that the object with the lower priority is active.

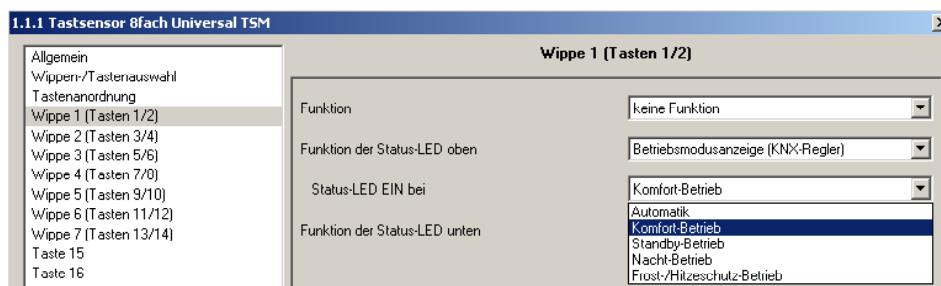

If a status LED is to indicate the operating mode, the communication object of the status LED must be linked with the matching object of the room temperature controller. The desired mode which the LED is to indicate can then be selected with the parameter "Status LED on with". The LED is then lit up when the corresponding mode of operation has been activated at the controller.

After a reset of the pushbutton sensor Universal TSM or after programming with the ETS, the value of the LED object is always "0" (automatic).

8.1.5 Function of the status LED as "controller status indicator"







If a status LED is to indicate the status of a room temperature controller, the controller extension must have been activated on parameter page "General". The status LED is then internally linked directly with the 1-byte object "**Controller status**" of the controller extension. This object must then be linked via a group address with the corresponding communication object of the controller.

The object "Controller status" groups eight different information units in a bit-oriented way in a byte. For this reason it is important to select in the "Status LED on with" parameter which information is to be indicated, i.e. which bit is to be evaluated.

The following bits can be selected...

- Bit 0: comfort operation
- Bit 1: standby operation
- Bit 2: night-time operation
- Bit 3: frost/heat protection
- Bit 4: controller disabled
- Bit 5: heating / cooling (heating = 1 7 cooling = 0)
- Bit 6: controller inactive (dead zone operation)
- Bit 7: frost alarm

Description of bit-oriented status messages of the room temperature controller (active = ON)

- **Comfort operation:**
active if operating mode "comfort '  "' or comfort extension "  " or "  " is activated.
- **Standby operation:**
active if the "standby '  "' operating mode is activated.
- **Night-time operation:**
active if the "night-time '  "' operating mode is activated.
- **Frost/ heat protection:**
active if the "frost/heat protection '  "' operating mode is activated.
- **Controller disabled:**
active if controller disable is activated (dew point mode).
- **Heating/cooling:**
active if heating is activated and inactive if cooling is activated. (as a rule inactive with controller disabled.)
- **Controller inactive:**
Active with the "heating and cooling" operation option when the measured room temperature lies within the dead zone. This status information is generally "0" for the individual "heating" or "cooling" options! (inactive if controller is disabled.)
- **Frost alarm:**
active if the detected room temperature reaches or exceeds + 5 °C.

The communication object "Controller status" of the controller extension updates itself automatically after a reset of the pushbutton sensor Universal TSM or after ETS programming, if the parameter "**Value request value by controller extension**" on parameter page "General" is set to "Yes". Updating is effected by means of a value read telegram to the room temperature controller. The controller must answer the request with a value return telegram. If the pushbutton sensor does not receive the answer, the status LED remains off (object value "0"). In this case, the object must first be actively rewritten by the bus after a reset before a status information can be indicated by the LED.

This is also the case, when the "Request value from controller extension" is set to "No".

8.1.6 Function of the status LED as "comparator"

The status LED can indicate whether a parameterized comparison value is greater than, equal to or less than the 1-byte object value of the status object. This comparator can be used for unsigned (0 ... 255) or for signed integers (-128 ... 127). The data format of the comparison is defined by the function of the status LED. The status LED lights up only if the comparison is "true".

After a reset of the pushbutton sensor Universal TSM or after ETS programming, the value of the LED object is always "0".

9 Scene control

The pushbutton sensor can be used in two different ways as part of a scene control system...

- Each rocker or key can work as a scene extension. This feature makes it possible to recall or to store scenes which may be stored in other devices.
- The pushbutton can independently store up to eight scenes with eight actuator groups. These internal scenes can be recalled or stored by the rockers or keys (internal scene recall) and also by the communication object "scene extension".
In the following subsections the internal scene function will be dealt with in greater detail.

9.1 Scene definition and scene recall

If the internal scenes are to be used, the parameter "Scene function" on parameter page "Scenes" must be set to "Yes". When the scene function is activated, the ETS renames the "Scenes" page "Scene data types". The matching data types for the eight scene outputs must then be selected and adapted to the actuator groups used. The types "Switching", "Value (0 ... 255)" or "Value / shutter position (0 ... 100%)" can be selected. As a rule, shutters are controlled via two scene outputs. One output controls the shutter height and the other one adjusts the slat position.

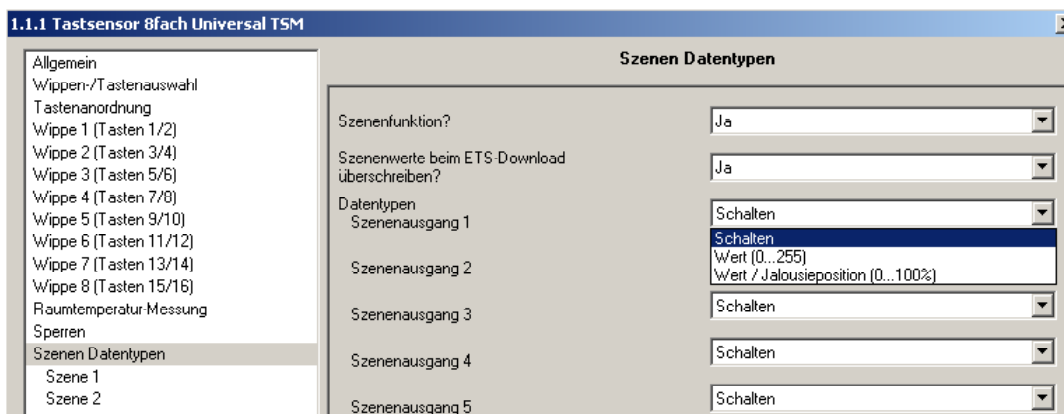

The ETS sets the corresponding communication objects and the parameters of the scene commands on the following parameter pages "Scene 1" to "Scene 8".

It is possible that the values for the individual scenes preset by the parameters are modified later on with the storage function when the system is in operation. If the application program is then loaded again with the ETS, these locally adapted values will be overwritten by the parameters. Due to the fact that it may take considerable efforts to readjust the values for all scenes in the system, the parameter "Overwrite scene values during ETS download ?" offers the possibility of retaining the scene values stored in operation without overwriting them.

The scene parameters can be set on the parameter page of each individual scene ("Scene 1 ... 8"). The setting options are the same for all 8 scenes.

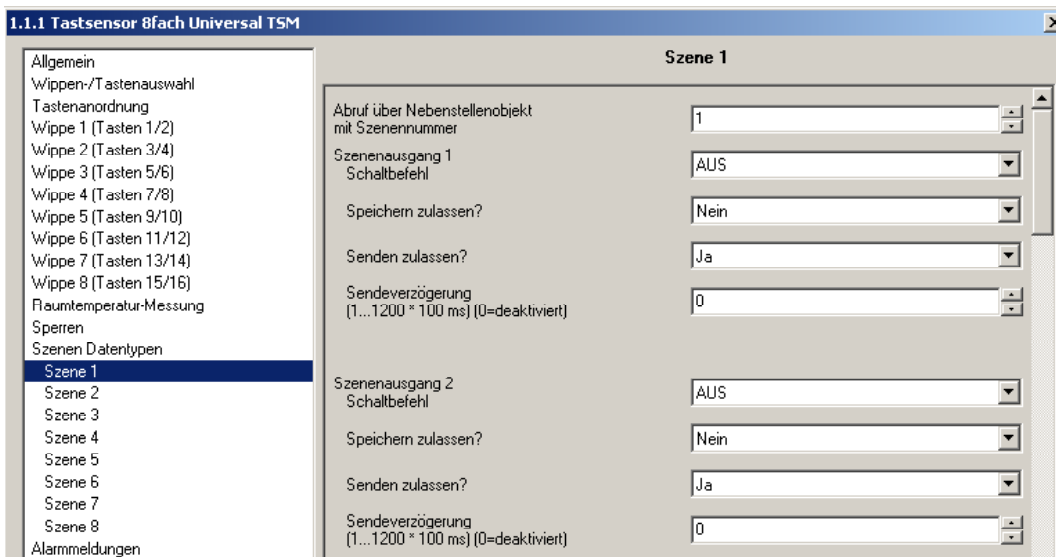

These internal scenes can be recalled directly via the rockers or keys (function "internal scene recall") and also by another bus device via the "scene extension input" communication object. This 1-byte communication object supports the evaluation of up to 64 scene numbers. For this reason it must be specified which of the external scene numbers (1 ... 64) is to recall the internal scene (1 ... 8). If the same scene number is listed for several internal scenes, it is always only the first of these scenes that will be activated (scene with the lowest scene number).

In some situations there may be the requirement that a group of actuators is not controlled by all, but only by certain scenes. A classroom, for instance, may require open blinds for the "Welcome" and "Pause" scenes, closed blinds in the "PC-presentation" scene and no change in the "Discussion" scene. In this example, the parameter "**Permit transmission ?**" can be set to "No" for the "Discussion" scene. The scene output is then deactivated during the corresponding scene.

The parameter "**Transmit delay**" permits entering an individual waiting time for each scene output. This transmit delay can be used in different situations...

- When the actuators participating in a scene transmit status messages automatically or when several scene keys are used to increase the number of channels within the scenes, the recall of a scene may result for a short time in high bus loading. The transmit delay helps to reduce the bus load at the time of scene recall.
- Sometimes, it is desirable that an action is started only after another action has ended. This can be for instance the lighting which is to shut off only after the blinds/shutters have been raised.

The transmit delay can be set separately for each scene output. The transmit delay defines the time between the individual telegrams during a scene recall. The setting specifies how much time must pass after the first scene telegram before the second is transmitted. After sending the second scene telegram, the parameterized time must again pass before the third is transmitted and so forth... The transmit delay for the first scene telegram starts immediately after the scene has been recalled.

The transmit delay between telegrams can also be deactivated (setting "0"). The telegrams are then transmitted at the shortest possible interval. In this case, however, the order of the telegrams transmitted can deviate from the numbering of the scene outputs.

When a new scene recall (also with the same scene number) occurs during a current scene recall - even in consideration of the pertaining transmit delays - the scene processing started first will be aborted and the newly received scene number will be processed. A running scene is also aborted when a scene is being stored! During a scene recall - even if delayed - the control surfaces of the pushbutton sensor are operational.

9.2 Storing scenes

For each output of a scene, the user can define a corresponding scene value in the ETS which is then transmitted to the bus during a scene recall. During the regular operation of the system it may be required to adapt these preset values and to store the adapted values in the pushbutton sensor Universal TSM. This can be ensured by the storage function of the scene control.

The value storage function for the corresponding scene number is enabled with the parameter "Permit storage" ("Yes") or disabled ("No"). When the storage function is disabled, the object value of the corresponding output is not sampled during storage.

A scene storage process can be initiated in two different ways...

- by a long press on a rocker or key of a control surface parameterized as "scene extension"
- by a storage telegram to the extension object.

During a storage process, the pushbutton sensor reads the current object values of the connected actuators. This is effected by means of eight read telegrams (ValueRead) addressed to the devices in the scene which return their own value (ValueResponse) as a reaction to the request. The returned values are received by the pushbutton sensor and taken over permanently into the scene memory. Per scene output, the pushbutton sensor waits one second for a response. If no answer is received during this time, the value for this scene output remains unchanged and the pushbutton sensors scans the next output.

In order to enable the pushbutton sensor to read the object value of the actuator addressed when a scene is stored, the read flag of the corresponding actuator object must be set. This should be done only for one actuator out of an actuator group so that the value response is unequivocal.

The stored values overwrite those programmed into the pushbutton sensor with the ETS.

The storage process will always be executed completely by the pushbutton sensor and cannot not be aborted before it has ended. Recalling scenes in the course of a storage process is not possible, the control surfaces of the pushbutton sensor remaining nevertheless operational.

10 Key disabling

With the 1-bit communication object "Key disabling", the control surfaces of the pushbutton sensor can be partly or completely disabled. During a disable, the rockers or keys can temporarily execute other functions as well. An active disable applies only to the functions of the rockers or keys. The functions of the status LED, room temperature measurement (only 8-gang), scene function and the alarm message are not affected by the disabling function.

The disabling function and the pertaining parameters and communication objects are enabled if the parameter "Disabling function ?" is set to "Yes" on the "Disabling" parameter page.

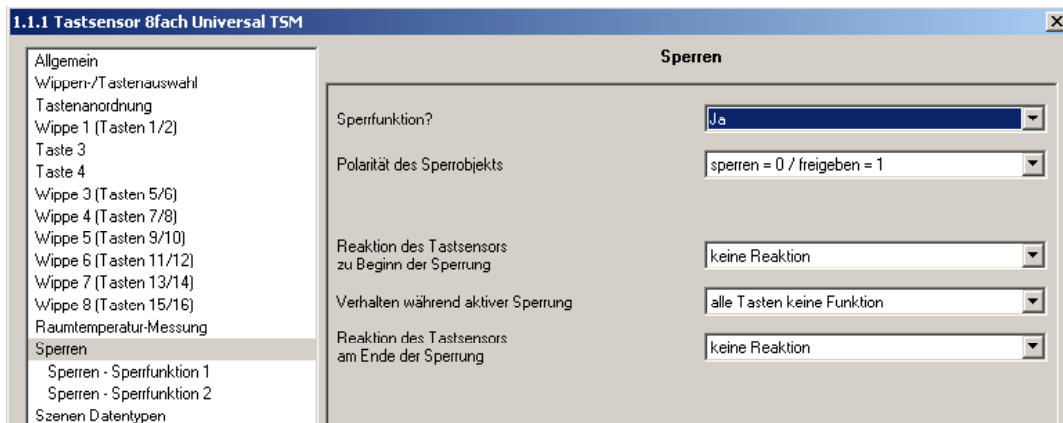

The polarity of the disabling object is parameterizable. In case of polarity inversion (disabled = 0 / enabled = 1), the disabling function is not activated immediately after a reset or after ETS programming (object value = "0"). There must first be an object update "0" until the disabling function will be activated. Telegram updates from "0" to "0" or from "1" to "1" on the "Key disabling" object remain without effect.

If the disabling function is used, the reaction of the pushbutton sensor on activation and deactivation of the disabling function can be preset separately in the parameters of the pushbutton sensor (parameter "Reaction of pushbutton sensor at the beginning / end of disabling"). In this connexion it is irrelevant which of the control surfaces is influenced and possibly also locked by disabling. The pushbutton sensor always shows the parameterized behaviour. The following settings are possible...

I. "No reaction":

The pushbutton sensor shows no reaction at the beginning and at the end of disabling. The sensor only adopts the state as provided for by the "Behaviour during active disabling".

II. "Internal scene recall scene 1 ...8":

The pushbutton sensor recalls one of the 8 internal scenes max. Scene storage is not provided for.

III. "Reaction like key >> X << / >> Y << on pressing /releasing":

The pushbutton sensor executes the function assigned to any "target key" in non-disabled state. Target keys are control keys of the pushbutton sensor which may be configured for rocker or for key operation. The target keys are parameterized separately for the beginning (X) or for the end (Y) of disabling (key X / Y: key to key 16 max.). For this purpose, the two keys of a rocker are considered as two separate keys.

The action parameterized for the respective target key is executed. If the target key is parameterized in such a way that it has no function or does not transmit a telegram on pressing or releasing of the key, then there is also no reaction to disabling or to re-enabling. If the selected target key is part of a parameterized rocker, the behaviour preset for the respective rocker side (rocker X.1 or X.2) will be used.

Table 1 shows all possible telegram reactions of the pushbutton sensor with respect to the target key function

Function of >>target key<<	Reaction "like >>target key<< on pressing"	Reaction "like >>target key<< on releasing"
Switching / switch-over	switching telegram	switching telegram
Dimming	switching telegram	no telegram
Shutter	move telegram	no telegram
Scene extension	scene recall telegram	no telegram
8-bit value transmitter	value telegram	no telegram
2-byte value transmitter	value telegram	no telegram
Temperature value transmitter	temperature value telegram	no telegram
Brightness value transmitter	brightness value telegram	no telegram
2-channel operation channel 1: 1-bit object type	switching telegram	no telegram
2-channel operation channel 1: 1-byte object type	value telegram	no telegram
2-channel operation channel 1: 2-byte object type	temperature value telegram	no telegram
Controller extension Operating mode selection	operating mode telegram	no telegram
Controller extension Presence detector	presence telegram	no telegram
Controller extension Setpoint shift	step value telegram	no telegram
No function	no telegram	no telegram

Table 1: Telegram reaction of the pushbutton sensor with respect to the target key function

The telegrams are transmitted via the required communication object of the target key to the bus.

IV. "Reaction like disabling function 1 / 2 on pressing / releasing":

The pushbutton sensor executes the function assigned to either of the two 'virtual' disabling functions. The disabling functions are internal key functions with independent communication objects and independent parameters. Except for the status LED, the setting possibilities available for disabling function 1 and disabling function 2 are the same as for the keys.

The respective parameterization of the predefined disabling function will be executed. If no function or no telegram is parameterized in the disabling function on pressing or releasing of a key, then there is also no reaction to disabling or to re-enabling.

Also for this case, table 1 shows all possible telegram reactions of the pushbutton sensor depending on programming of the disabling function.

The telegrams are transmitted to the bus via the required communication object of the disabling function.

Irrespective of the behaviour shown by the pushbutton sensor at the beginning or at the end of disabling, the control keys can be separately influenced during disabling.

During disabling...

- all keys may be without function.
In this case, the pushbutton sensor is completely locked during disabling. Pressing a key has no effect. The status LEDs of the disabled keys are without function (no key-press indication either). Only the "always ON" or "always OFF" state remains unaffected by the disabling function.
- all keys can behave like predefined keys.
All keys behave as defined in the parameters for the two specified reference keys of the pushbutton sensor. The parameter "All even / odd keys behave during disabling like" defines the reference keys (key 1 to key 16 max.) For all control keys with an even number (2, 4, 6, ...) and for all keys with an odd number (1, 3, 5, ...) it is possible to program not only different reference keys, but also identical reference keys. The two 'virtual' disabling functions of the pushbutton sensor can also be parameterized as a reference key.
The telegrams are transmitted to the bus via the communication objects of the specified reference keys. The status LEDs of the reference keys are controlled in conformity with their function. The status LEDs of the disabled keys are without function (no key-press indication either). Only the "always ON" or "always OFF" state remains unaffected by the disabling function.
- individual keys may be without function.
Only the individually specified keys are locked during disabling. The other control keys remain unaffected by disabling. The keys that will be locked are defined in the parameters on the "Disable – Key selection" page. The status LEDs of the disabled keys are without function (no key-press indication either). Only the "always ON" or "always OFF" state remains unaffected by the disabling function.
- individual keys can behave like predefined keys.
Only the individually specified keys behave as defined in the parameters of the two specified reference keys of the pushbutton sensor. The parameter "All even / odd keys behave during disabling like" defines the reference keys (key 1 to key 16 max.) For all control keys with an even number (2, 4, 6, ...) and for all keys with an odd number (1, 3, 5, ...) it is possible to program not only different reference keys, but also identical reference keys. The two 'virtual' disabling functions of the pushbutton sensor can also be parameterized as a reference key. The keys that will be locked are defined in the parameters on the "Disable – Key selection" page.
The telegrams are transmitted to the bus via the communication objects of the specified reference keys. The status LEDs of the reference keys are controlled in conformity with their function. The status LEDs of the disabled keys are without function (no key-press indication either). Only the "always ON" or "always OFF" state remains unaffected by the disabling function.

Notes on activating and deactivating of a disabling function:

If a key scan is taking place at the time of activation / deactivation of a disabling function, this function is aborted immediately and with it also the pertaining key function. It is first necessary to release all keys before a new key function can be executed if so permitted by the state of disabling.

3-key press

In case of the pushbutton sensor variants 4-gang and 8-gang, an active disable can be released by means of the so-called 3-key press. For this purpose, keys T1, T5 and T8 (see Figs. 5 & 6 for pushbutton sensor 4-gang, 8-gang device analogous - observe key layout!) must be pressed and held down for at least 5 seconds.

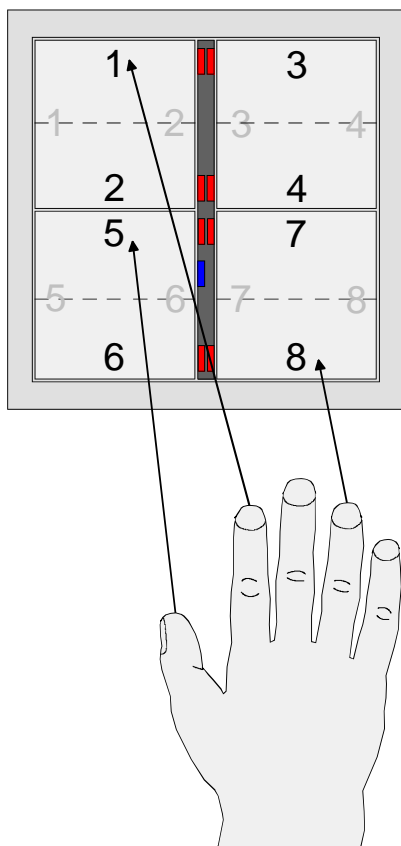

Fig. 5: 3-key actuation with top / bottom key layout

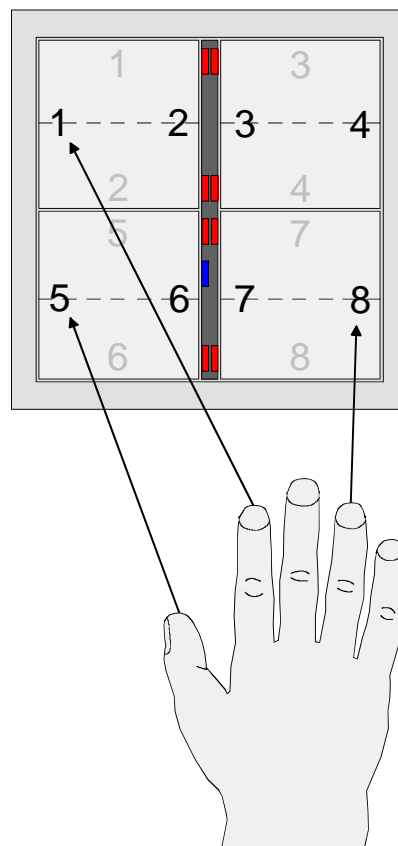

Fig. 6: 3-key actuation with left / right key layout

If the 3-key press is to be used, it must be ensured that the layout of keys 1, 5 and 8 is selected identical in the ETS parameters. The 3-key press can otherwise not always be reliably evaluated

For re-enabling the key operation, all keys must first be released before a new press can be evaluated. Since the 3 keys are generally not pressed at the same time, there is the possibility of a telegram being transmitted if (at least) one of the three keys has a function assigned to it.

On deactivation of the disabling function by means of the 3-key press, the disable object will be updated (disabling inactive) and the new object value actively transmitted to the bus, if the transmit flag of the object is set.

In the default state, this flag is cleared.

11 Controller extension:

11.1 Connection to room temperature controller

For controlling of a KNX/EIB room temperature controller, the controller extension function can be activated. The controller extension function is enabled with the parameter "**Controller extension**" on the "**General**" page

The controller extension itself is not involved in the regulating process. With the controller extension function, the user can operate the single-room regulation from different places in the room. The controller extension can also be used to adjust central heating control units which are located, for instance, in a switch cabinet
Typical KNX/EIB room temperature controller generally offer different ways of influencing or visualizing the room temperature regulation.

- Switching over between different modes of operation (e.g. "Comfort", "Night" ...) with different setpoint temperatures assigned to each mode by the controller
- Detecting the presence of a person in a room. The detection may also be combined with a parameterized change of the mode of operation.
- Readjustment of the setpoint temperature in steps which are referred in each case to the parameterized setpoint temperature of the current mode of operation (basic setpoint shift).

The pushbutton sensor Universal TSM permits by means of its control keys the complete control of a room temperature controller by changing the mode operation, by predefining the presence situation or by readjusting the setpoint shift (cf. the following sub-chapters). For this purpose, the keys of the pushbutton sensor selected as extension operation keys must be parameterized for the "Controller extension" function. It should be noted that an extension operation is possible only if one control surface is configured as a key and if the controller extension function has been enabled on the "General" page. In all other cases, the controller extension function is not operational.

In addition, the pushbutton sensor can – independent of the controller extension function – indicate the state of one or more room temperature controllers with the status LEDs of the keys or rockers. This feature permits the indication of modes of operation or the bit-oriented evaluation of different status objects of controllers (cf. chapter "8. Status LEDs").

In case of the controller extension functions "Setpoint shift" or "Presence function", the status LEDs can also signal the state of the corresponding functions directly.

The controller extension can work properly only if all extension objects are linked with the corresponding objects of the room temperature controller (cf. Fig. 7). The controller extension with the objects is existing only once in the pushbutton sensor. All key functions parameterized for the controller extension act on the objects belonging to the extension. Several controller extensions can also act on one main controller.

Nummer	Name	Funktion	Länge	K	L	S	Ü	A
58	Reglernebenstelle	Betriebsmodus-Umschaltung	1 Byte	K	-	S	Ü	A
59	Reglernebenstelle	Zwang Betriebsmodus-Umschalt.	1 Byte	K	-	S	Ü	A
60	Reglernebenstelle	Präsenztaste	1 bit	K	-	S	Ü	A
61	Reglernebenstelle	Ausgang Sollwertverschiebung	1 Byte	K	-	-	Ü	-
62	Reglernebenstelle	Eingang Sollwertverschiebung	1 Byte	K	-	S	Ü	A
63	Reglernebenstelle	Regler Status	1 Byte	K	-	S	Ü	A

Fig. 7: Communication objects of the controller extension

The communication object "Operating mode switch-over", "Forced operating mode switch-over", "Presence key", "Setpoint shift input" and "Controller status" of the controller extension updates itself automatically after a reset of the pushbutton sensor Universal TSM or after ETS programming, if the parameter "Request value from controller extension" on parameter page "General" is set to "Yes". Updating is effected by means of a ValueRead telegram to the room temperature controller. The controller must answer the request with a ValueResponse telegram. If the pushbutton sensor does not receive all or some of the answers, the affected objects are initialized in the pushbutton sensor TSM with "0". In this case, the objects must first be actively rewritten by the bus after a reset. This is also the case, when the "Request value from controller extension" is set to "No".

11.2 Key functions for "Mode of operation switch-over" and "Forced mode of operation switch-over"

Changeover of the controller operating mode can be effected in accordance with the standard function block for room temperature controllers defined in the Konnex handbook with two 1-byte communication objects. The operating mode can be switched over with the normal and with the forced-control object. The "Operating mode switch-over" object offers a selection between the following operating modes...

- Comfort
- Standby
- Night-time operation
- Frost / heat protection

The "Forced operation mode switch-over" communication object has the higher priority. The "Forced operating mode switch-over" object permits forced switching between the following modes of operation...

- Auto (normal operating mode switch-over)
- Comfort
- Standby
- Night-time operation
- Frost / heat protection

The operating mode transmitted to the bus on a key-press of the controller extension is defined by the parameter "Operating mode on key-press". Depending on the parameterized functionality, it is possible that ...

- either one of the above-mentioned modes is activated (single selection) on the press of the key,
- or the device is switched over between two or three modes (multiple selection).

Notes on multiple selection:

In order to ensure that a switch-over from one mode into another works properly even from different locations, the operating mode objects of the controller and those of all controller extension pushbutton sensors must be interlinked and have their "Write" flag set. In the objects concerned this flag is set by default

By checking the linked operating mode switch-over object, the controller extension knows which of the possible operating modes is active. Based on this information, the device switches over into the next operating mode in sequence when a key is pressed. In the event that none of the possible operating modes is active, the next operating mode in the sequence is set to "Comfort" operation (in case of "Standby - >Night" to "Standby" operation). As far as switching over between the forced operating modes and "Auto" is concerned, the device switches into the "Auto" operating mode when none of the parameterized operating modes is active.

It is not possible to program a reaction on release of the key. A long key-press is evaluated in the same way as short one and switches into the corresponding mode of operation in so far as this is acceptable for the controller.

If a status LED is to indicate the current mode of operation, the status LED function must be programmed for "Operating mode indication" and its status object be linked with the corresponding group address for switching with normal or high priority (cf. chapter "8. Status LEDs").

11.3 Key function "Presence key"

All key with their function set to "Presence key" are internally linked with the "Presence key" object of the controller extension. The parameter "**Presence function on key-press**" defines the object value transmitted to the bus on pressing a key.

In order to ensure that the object value transmitted in the "Presence UM" setting is always the correct one, the presence object of the room temperature controller and the "Presence key" objects of the controller extension pushbutton sensors must be interlinked and have their "Write" flag set. In the extension objects concerned this flag is set by default.

It is not possible to program a reaction on release of the key. A long key-press is evaluated in the same way as short one and switches into the corresponding mode of operation in so far as this is acceptable for the controller.

The status LED of the presence key can indicate both the presence status (setting "Key function indication active / inactive") and also the actuation of the key. In addition, the usual setting possibilities of the status LED are parameterizable as well (cf. chapter "8. Status LEDs").

11.4 Key function "Setpoint shift"

The setpoint shift is another available function of the controller extension. It makes use of two 1-byte communication objects with data point type 6.010 (integer with sign). This extension function allows to shift the basic setpoint for the temperature on the room temperature controller by actuating a key. Operation of the extension is generally the same as the operation of the main controller

A key parameterized as setpoint shifting key reduces or increases the setpoint shift value on each press by one step respectively. The direction of the value variation is defined by the parameter "**Setpoint shift on key-press**". Releasing the key and a long press have no other functions.

Communication with main controller:

In order to enable the pushbutton sensor Universal TSM to effect a setpoint shift in a room temperature controller, the controller must have input and output objects for setpoint shifting. In this case, the output object of the controller must be linked with the input object of the extension and the input object of the controller must be linked with the output object of the extension via an independent group address.

All objects are of the same data point type and have the same value range. A setpoint shift is interpreted by count values: a shift in positive direction is expressed by positive values whereas a shift in negative direction is represented by negative object values. An object value of "0" means that no setpoint shift has been activated.

Via the "Setpoint shift input" object of the controller extensions which is linked with the room temperature controller the extension are enabled to determine the current setpoint shift position. Starting from the value of the communication object, each key-press on an extension will adjust the setpoint in the corresponding direction by one count value step. Each time the setpoint is adjusted, the new shift is transmitted to the room temperature controller via the "Setpoint shift output" object of the controller extension to the room temperature controller. The controller itself checks the received value for the minimum and maximum temperature limits (see controller documentation) and adjusts the new setpoint shifting if the values are valid. When the new count value is accepted as valid, the controller transfers this value to its output object for setpoint shifting and retransmits the value to the extension as positive feedback.

Due to the standard data point type used as the output and input object of the controller extension and the weighting of the individual stage by the controller itself, each extension is able to determine whether a shifting took place, in which direction it took place and by how many steps the setpoint was shifted. This requires that the communication objects are connected on all controller extensions and the controller .

The information for the step value as feedback from the controller enables the extension to continue the adjustment anytime at the right point. The extensions can equally react to a reset of the setpoint shifting function by the controller.

The status LED of a setpoint shifting key can indicate both the setpoint shifting status (setting "Setpoint shift indication") and also the actuation of the key. In addition, the usual setting possibilities of the status LED are parameterizable as well (cf. chapter "8. Status LEDs").

For setpoint shifting status indication, the controller makes use of the step count value which is transmitted to the extension and evaluated for switching of the status LED. The "Status LED" parameter defines the switching behaviour: The LED can be permanently off and light up only after a shift has been detected (setting "ON, ..."). As an alternative, the LED can be permanently on and go out only after a shift has been detected (setting "OFF, ..."). It can also be distinguished whether the LED is ON or OFF only if ...

- there has been shifting at all
- only a positive shift has been detected,
- only a negative shift has been detected.

12 Room temperature measurement (only 8-gang)

The pushbutton sensor Universal TSM 8-gang features an integrated temperature sensor. In those cases where room temperature controllers due to their fitting location cannot measure the actual room temperature themselves or only imprecisely, it is possible to use the pushbutton sensor Universal TSM 8-gang alternatively or additionally for room temperature measurements.

This function must be enabled in the pushbutton sensor 8-gang with the parameter "Room temperature measurement" on parameter page "General". After enabling, the ETS presents the parameter page "Room temperature measurement" with further parameters.

The temperature measurement of the pushbutton sensor is sufficiently precise only if the following marginal conditions are respected in the selection of the fitting location.

- The touch sensor should not be used in multiple combinations, especially together with flush-mounted dimmers.
- The pushbutton sensor should not be installed in the vicinity of large electrical consumers (heat radiation).
- The touch sensor should not be installed in the vicinity of heaters or cooling systems.
- The temperature sensor should not be exposed to direct sunlight.
- The installation of sensors on the inside of an outside wall might have a negative impact on the temperature measurement.
- Temperature sensors should be installed at least 30 cm away from doors or windows and at least 1.5 m above the floor.

The pushbutton sensor Universal TSM 8-gang measures the room temperature and transmits the temperature value by means of the 2-byte object "Measured room temperature" to the bus. This object is generally linked with the object of the external temperature sensor of a room temperature controller.

For cascading several temperature measurements, the 2-byte communication object "External temperature sensor" is available as an option. This object can be used to add another KNX/EIB-suited temperature sensor and to integrate it into the temperature measurement.

With regard to this additional option, the following settings are available on parameter page "Room temperature measurement".

- "Temperature measurement by"
This item specifies whether the room temperature is determined only with the internal sensor of the pushbutton sensor Universal TSM 8-gang or in addition also by an external sensor. If an external temperature sensor is used, the room temperature controller waits after a reset for a temperature value telegram from the external sensor. The pushbutton sensor measures the room temperature and transmits it to the bus only after the telegram has been received.
- "Measured value formation"
If "Internal and external sensor" is selected, the actual room temperature is formed from the two measured temperature values. The weighting of the temperature values is determined by the parameter "Measured value formation". Different fitting locations of the sensors or a possible non-uniform heat distribution inside the room can thus be taken into account in adjusting the room temperature measurement. Often, those temperature sensors that are subject to negative external influences (for example, unfavourable location because of exposure to sun or heater or door / window directly next to it) are weighted less heavily.

Example:

The pushbutton sensor has been installed next to the entrance door. An additional external temperature sensor has been mounted on an inner wall in the middle of the room below the ceiling.

Internal sensor: 21,5 °C (internal sensor measuring range: + 5 °C ...+ 35 °C ±1 %)

External sensor: 22.3 °C

Measured value formation: 30 % to 70 %

Result: $T_{\text{result internal}} = T_{\text{internal}} \cdot 0.3 = 6.45 \text{ °C}$, $T_{\text{result external}} = T_{\text{external}} = 22.3 \text{ °C} \cdot 0.7 = 15.61 \text{ °C}$
→

$T_{\text{result actual}} = T_{\text{result internal}} + T_{\text{result external}} = \underline{\underline{22.06 \text{ °C}}}$

- "Internal / external sensor adjustment"
Due to component tolerances and different fitting conditions and current loading of the BCU, the originally measured values of the internal and the external sensor can deviate from the true room temperature. Both sensors can therefore be set to independent adjusting values. A calibration becomes necessary, if the temperature measured by the sensors stays permanently below or above the actual room temperature in the vicinity of the sensor. To quantify the deviation, the actual room temperature should be determined by a reference measurement with a calibrated temperature measuring device.
With the parameter "**Internal sensor calibration...**" or "**External sensor calibration...**", a positive (temperature increase, factors: 1 ... 127) or a negative (temperature decrease, factors: -128 ... -1) temperature calibration in steps of 0.1 °C can be parameterized. Thus, the calibration is made only once and is the same for all operating modes.

Notes:

- The measured value has to be increased, if the value measured by the sensor lies below the actual room temperature. The measured value has to be decreased, if the value measured by the sensor lies above the actual room temperature.
- The temperature value transmitted to the bus is always the calibrated one.
- "Interrogation interval for external sensor":
If the external sensor does not transmit its measured values automatically, the pushbutton sensor can request the values from the sensor at regular interrogation intervals (ValueRead - "Read" flag for external sensor must have been set). The time interval at which the external sensor is regularly interrogated, can be set with the parameter "**Interrogation interval for external sensor**". The interrogation interval can be set from 1 minute to 255 minutes. If "0" is selected as the interrogation interval, the automatic value request is deactivated.
If the request from the pushbutton sensor is not answered, the pushbutton sensor continues to use the still valid value of the communication object of the external sensor. After a reset, the value is no longer valid and must be updated at least once by the bus.
- "**Cyclical transmission of room temperature**" & "**Transmission if room temperature value changes by...**":
The pushbutton sensor transmits the result of the room temperature measurement to the bus either in case of a parameterized change or within a selectable transmission cycle. The parameter "**Transmission if room temperature value changes by...**" fixes the temperature value by which the determined temperature must change before the room temperature value is automatically transmitted. Possible temperature value changes lie within a range of 0.1 °K and 25.5 °K. If "0" is selected, the automatic transmission of the room temperature after a value change is deactivated.
In addition, the determined room temperature value can be transmitted cyclically, especially if no temperature change is expected during prolonged periods. The "**Cyclical transmission of room temperature**" parameter determines the cycle time (1 to 255 minutes). If "0" is selected, the cyclical transmission of the room temperature is deactivated. If both transmission criteria are used, they are independent of one another. This means that the transmission of the temperature after a value change does not restart the cycle time.
After a reset or after programming of the pushbutton sensor with the ETS, the object is re-initialized with the current room temperature and actively transmitted to the bus. In this case, the pushbutton sensor observes the transmission delay, if parameterized. The automatic transmission after a reset will, however, only be effected, if the factor of the parameter "**Transmission if room temperature value changes by...**" is set to values greater than "0".

13 Alarm signalling

The pushbutton sensor Universal TSM permits signalling of a alarm which might be, for instance, a burglar or a fire alarm from a KNX/EIB central alarm unit. An alarm is signalled by all status LEDs and of the operation LED of the pushbutton sensor blinking synchronously. The alarm can be separately enabled with the parameter "Signalling of an alarm" on parameter page "**Alarm signalling**" so that it can be used.

When alarm signalling is enabled, the ETS displays the communication object "**Alarm signalling**" and further alarm function parameters.

The alarm signalling object is used as an input for activating or deactivating the signalling of an alarm. The polarity of the object can be selected. When the object value corresponds to the "alarm" condition, all status LEDs and the operation LED are always blinking with a frequency of ca. 2 Hz. In case of an alarm, the basic parameters set for the LEDs are of no importance. The LEDs adopt their originally parameterized behaviour only after the alarm signalling function has been deactivated. Changes of the state of the LEDs during an alarm - if they are controlled by separate LED objects or if they signal key functions - are internally stored and recovered at the end of the alarm.

Apart from the possibility of deactivating an alarm signal via the alarm object, it can also be deactivated locally by a key-press on the pushbutton sensor itself. The parameter "Reset alarm signalling by key-press?" defines the key response during an alarm...

- If this parameter is set to "Yes", an active alarm signalling can be deactivated by a key-press on the pushbutton sensor. This key-press does not cause the parameterized function of the pressed key to be executed. Only after the next key-press will the parameterization of the key be evaluated and a telegram be transmitted to the bus, if applicable.
- If "No" has been selected, alarm signalling can only be deactivated via the alarm object. A key-press will always directly execute the parameterized key function.

If an alarm signalling can be deactivated by a key-press, the parameter "**Acknowledge alarm signalling by**" defines whether an additional alarm acknowledge telegram is to be transmitted to the bus via the separate object "Alarm signalling acknowledge" after triggering by this key-press.

Such an acknowledge telegram can, for instance, be sent via a 'listening' group address to the "Alarm signalling" objects of other pushbutton sensors in order to reset the alarm status there as well. Attention must be paid during resetting of an alarm to the selectable polarity if the acknowledge object.

Notes on the alarm signalling function:

- Polarity of the alarm object: If the setting is "Alarm when OFF and alarm reset when ON", the alarm object must be actively written by the bus with "0" to activate the alarm after a reset or after programming with the ETS.
- An active alarm signalling is not stored so that the alarm signalling is generally deactivated after a reset or after programming with the ETS.

Parameters		
Description	Values:	Comment:
<input type="checkbox"/> General		
Transmit delay after reset or bus voltage return	Yes NO	<p>After a reset (e.g. after loading of an application program or the physical address or after return of bus voltage), the pushbutton sensor (only 8-gang) can automatically transmit telegrams for the functions room temperature controller extension and room temperature measurement. In case of the controller extension, the pushbutton sensor attempts to retrieve values from the room temperature controller by means of read telegrams in order to update the object states. In case of the room temperature measurement, the pushbutton sensor transmits the current room temperature after a reset to the bus.</p> <p>If there are still other bus devices besides the pushbutton sensor transmitting telegrams immediately after a reset, it may be useful to activate the transmit delay for automatically transmitting objects in order to reduce the bus load.</p> <p>When transmit delay is activated (setting: "Yes"), the pushbutton sensor computes the delay from its device ID in the physical address.</p> <p>The sensor then waits 30 seconds maximum before transmitting telegrams.</p>
ON-time of status LEDs as actuation indicators	1s 2s 3s 4s 5s	<p>This parameter defines the time the status LED is lit up to indicate actuation. The setting concerns all status LEDs whose function is set to "Actuation indicator"</p>

<p>Function of status LED</p>	<p>always off always ON</p> <p>switching via object</p> <p>inverted switching via object</p>	<p>This parameter defines the function of the operation LED.</p> <p>The operation LED is always off.</p> <p>The operation LED is always on, for instance, as orientation lighting.</p> <p>The operation LED is controlled by a separate communication object ("1" = ON; "0" = OFF).</p> <p>The operation LED is controlled with inversion by a separate communication object ("1" = OFF; "0" = ON).</p> <p>Besides this function, the operation LED can display different states by means of other blinking rates. These comprise the programming mode, the confirmation of full-surface actuation or the message that an application has not been loaded</p>
<p>Controller extension:</p>	<p>enabled disabled</p>	<p>This parameter enables the communication objects and the parameter page for the room temperature controller extension. In addition, at least one rocker must be divided into two keys to permit full use of the controller extension features.</p>
<p>Value request from controller extension?</p>	<p>Yes NO</p>	<p>In order to enable the pushbutton sensor to transmit the correct values after a press on the keys representing the controller extension, the "Operating mode switch-over", "Forced operating mode switch-over" and "Presence key" communication objects can transmit read requests after a reset.</p> <p>Only visible, if the parameter "Controller extension" is set to "enabled".</p>
<p>Room temperature measurement</p>	<p>enabled disabled</p>	<p>This parameter activates the communication objects and the parameter page for room temperature measurement.</p> <p>Only visible with pushbutton sensor Universal TSM 8-gang!</p>

<input type="checkbox"/> Rocker / key selection		
Function of keys 1 and 2 (the same parameters are available for the other control surfaces / key pairs)	as a rocker (rocker 1) as separate keys	For each control surface the user can independently specify whether it is to be used as a rocker with a common basic function or as two different keys with completely independent functions. Depending on this choice, the ETS displays different communication objects and parameter pages. If a control surface is parameterized as a rocker, it is also possible to activate a full-surface actuation with some basic functions.
<input type="checkbox"/> Key arrangement		
Key arrangement Key 1 / key 2 (the same parameters are available for the other control surfaces / key pairs)	left / right top / bottom	For each control surface the user can specify whether the surface is to be divided horizontally or vertically in order to fix the respective actuation points on the control surface.
<input type="checkbox"/> Rocker 1 (keys 1/2) (only if "Function of keys 1 and 2 = as one rocker (rocker 1)")!		
Function	no function switching dimming blind/shutter Value transmitter 1 byte Value transmitter 2 bytes Scene extension 2-channel operation	This parameter is used to define the basic function of the rocker. Depending on this choice, the ETS displays different communication objects and parameters.
The status LEDs of a control surface can be programmed for independent LED functions with no relationship to the basic functions of the rocker. This always results in the parameters described below...		
If the function of the status LED = "Operating mode indicator (KNX controller)"		
Status LED ON with	automatic operation comfort operation standby operation night-time operation frost /heat protection	The values of a communication object with data type 20.102 "HVAC Mode" are defined as follows: Duration of frost protection automatic mode (1...255) * 1 min. 1 = comfort 2 = standby 3 = night-time 4 = frost/ heat protection The value "automatic" is used only by the "forced operating mode switch-over" objects The status LED is on when the object adopts the parameterized value.

If the function of the status LED = "Controller status indicator"		
Status LED ON with	comfort operation standby operation night-time operation frost /heat protection controller disabled heating / cooling: controller inactive (dead zone operation) frost alarm	The communication object "Controller status" of the controller extension function includes 8 bits of information in one byte. This parameter defines which bit is to be indicated by the LED. The indication of the controller status is possible only when the controller extension function is enabled (parameter page "General")
If the function of the status LED = "Comparator without sign"		
Status LED ON with	reference value greater than received value reference value less than received value reference value equal to received value	The status LED indicates whether the parameterized reference value is greater or less than or equal to the value of the "Status LED" object.
Reference value (0 ... 255)	0 ... 255	This parameter defines the reference value to which the value of the "Status LED" object is compared.
If the function of the status LED = "Comparator with sign"		
Status LED ON with	reference value greater than received value reference value less than received value reference value equal to received value	The status LED indicates whether the parameterized reference value is greater or less than or equal to the value of the "Status LED" object.
Reference value (-128 ... 127)	-128 ... 0 ... 127	This parameter defines the reference value to which the value of the "Status LED" object is compared.
If the function of the rocker = "No function"		
Function of status LED at the top	always off always ON status indication (LED object) inverted status indication (LED object) operating mode indicator (KNX controller) controller status indicator (activate controller extension!) comparator without sign (1 byte) comparator with sign (1 byte)	When the rocker is not used, the status LED can <ul style="list-style-type: none"> • be permanently on or off independent of the communication objects, • signal a state of the controller extension, • perform a comparison, • show the state of the own LED object. Depending on this setting, the ETS may also display further LED parameters.

<p>Function of status LED at the bottom</p>	<p>always off always ON status indication (LED object) inverted status indication (LED object) operating mode indicator (KNX controller) controller status indicator (activate controller extension!) comparator without sign (1 byte) comparator with sign (1 byte)</p>	<p>When the rocker is not used, the status LED can</p> <ul style="list-style-type: none"> • be permanently on or off independent of the communication objects, • signal a state of the controller extension, • perform a comparison, • show the state of the own LED object. <p>Depending on this setting, the ETS may also display further LED parameters.</p>
<p>If the function of the rocker = "switching"</p>		
<p>Function of status LED at the top</p>	<p>always OFF always ON key-press indicator status indicator (switching object) inverted status indicator (switching object) status indicator (LED object) inverted status indicator (LED object) operating mode indicator (KNX controller) controller status indicator (activate controller extension!) comparator without sign (1 byte) comparator with sign (1 byte)</p>	<p>With a switching function the status LED can...</p> <ul style="list-style-type: none"> • be permanently on or off independent of the communication objects, • signal a key-press, • signal the state of the communication object "Switching" • signal a state of the controller extension, • perform a comparison, • show the state of the own LED object. <p>Depending on this setting, the ETS may also display further LED parameters.</p>
<p>Function of status LED at the bottom</p>	<p>always OFF always ON key-press indicator status indicator (switching object) inverted status indicator (switching object) status indicator (LED object) inverted status indicator (LED object) operating mode indicator (KNX controller) controller status indicator (activate controller extension!) comparator without sign (1 byte) comparator with sign (1 byte)</p>	<p>With a switching function the status LED can...</p> <ul style="list-style-type: none"> • be permanently on or off independent of the communication objects, • signal a key-press, • signal the state of the communication object "Switching" • signal a state of the controller extension, • perform a comparison, • show the state of the own LED object. <p>Depending on this setting, the ETS may also display further LED parameters.</p>

Command on pressing rocker 1.1	no reaction ON OFF TOGGLE	Depending on the " Key arrangement " parameter, these parameters define the reaction taking place when the top (or left-hand) rocker is pressed or released.
Command on releasing rocker 1.1	no reaction ON OFF TOGGLE	
Command on pressing rocker 1.2	no reaction ON OFF TOGGLE	Depending on the "Key arrangement" parameter, these parameters define the reaction taking place when the bottom (or right-hand) rocker is pressed or released.
Command on releasing rocker 1.2	no reaction ON OFF TOGGLE	
If the function of the rocker = "dimming"		
Function of status LED at the top	always off always ON key-press indicator status indicator (switching object) inverted status indicator (switching object) status indicator (LED object) inverted status indicator (LED object) operating mode indicator (KNX controller) controller status indicator (activate controller extension!) comparator without sign (1 byte) comparator with sign (1 byte)	With a dimming function the status LED can... <ul style="list-style-type: none"> • be permanently on or off independent of the communication objects, • signal a key-press, • signal the state of the communication object "Switching" • signal a state of the controller extension, • perform a comparison, • show the state of the own LED object. <p>Depending on this setting, the ETS may also display further LED parameters.</p>
Function of status LED at the bottom	always off always ON Key-press indicator status indicator (switching object) inverted status indicator (switching object) status indicator (LED object) inverted status indicator (LED object) operating mode indicator (KNX controller) controller status indicator (activate controller extension!) comparator without sign (1 byte) comparator with sign (1 byte)	With a dimming function the status LED can... <ul style="list-style-type: none"> • be permanently on or off independent of the communication objects, • signal a key-press, • signal the state of the communication object "Switching" • signal a state of the controller extension, • perform a comparison, • show the state of the own LED object. <p>Depending on this setting, the ETS may also display further LED parameters.</p>

Command on pressing rocker 1.1	no reaction brighter (ON) darker (OFF) brighter / darker (TOGGLE) brighter (TOGGLE) darker (TOGGLE)	Depending on the "Key arrangement" parameter, this parameter defines the reaction taking place when the top (or left-hand) rocker is pressed. If the pushbutton sensor is to toggle on a brief press, the corresponding switching objects of other sensors with the same function must be linked with one another. In the "Brighter/darker (TOGGLE)" setting, the dimming objects must be interlinked as well so that the pushbutton sensor can send the correct telegram on the next key-press.
Command on pressing rocker 1.2	no reaction brighter (ON) darker (OFF) brighter / darker (TOGGLE) brighter (TOGGLE) darker (TOGGLE)	Depending on the "Key arrangement" parameter, this parameter defines the reaction taking place when the bottom (or right-hand) rocker is pressed. If the pushbutton sensor is to toggle on a brief press, the corresponding switching objects of other sensors with the same function must be linked with one another. In the "Brighter/darker (TOGGLE)" setting, the dimming objects must be interlinked as well so that the pushbutton sensor can send the correct telegram on the next key-press.
Time between switching and dimming rocker 1.1 (100 ... 50000 x 1 ms)	100 ... 400 ... 50000	This parameter defines how long the top (or left-hand) rocker must be pressed for the pushbutton sensor to send a telegram.
Time between switching and dimming rocker 1.2 (100 ... 50000 x 1 ms)	100 ... 400 ... 50000	This parameter defines how long the bottom (or right-hand) rocker must be pressed for the pushbutton sensor to send a telegram.
Advanced parameters	activated deactivated	When the advanced parameters are activated, the ETS shows the following parameters.
Advanced parameters activated...		
Increase brightness by	1.5 % 3 % 6 % 12.5 % 25 % 50 % 100 %	This parameter sets the relative dimming step when the brightness is increased. On each key-press, the brightness is changed at maximum by the parameterized step Especially with smaller dimming steps it is recommended that the pushbutton sensor repeats the dimming telegrams automatically (cf. "Telegram repetition").

Reduce brightness by	<p>1.5 % 3 % 6 % 12.5 % 25 % 50 % 100 %</p>	<p>This parameter sets the relative dimming step when the brightness is reduced. On each key-press, the brightness is changed at maximum by the parameterized step</p> <p>Especially with smaller dimming steps it is recommended that the pushbutton sensor repeats the dimming telegrams automatically (cf. "Telegram repetition").</p>
Transmit stop telegram ?	<p>yes no</p>	<p>For "Yes" the pushbutton sensor transmits a telegram for stopping the dimming process when the rocker is released. When the pushbutton sensor transmits telegrams for dimming in smaller steps, the stop telegram is generally not needed.</p>
Telegram repetition?	<p>yes no</p>	<p>This parameter can be used to activate telegram repetition for dimming. With the key held down, the pushbutton sensor will then transmit the relative dimming telegrams (in the programmed step size) until the key is released.</p>
Time between two telegrams	<p>200 ms 300 ms 400 ms 500 ms 750 ms 1 s 2 s</p>	<p>This parameter defines the interval at which the dimming telegrams are automatically repeated in the telegram repetition mode.</p> <p>Visible only if "Telegram repetition = Yes"!</p>
Full-surface actuation	<p>enabled disabled</p>	<p>When full-surface actuation is enabled, the ETS shows the following parameters.</p>
Function in case of full-surface actuation	<p>switching scene recall without storage function scene recall with storage function</p>	<p>In case of full-surface operation, this parameter defines the function that is to be used. The ETS shows the corresponding communication object and the other parameters.</p> <p>If the pushbutton sensor is to recall a scene with storage function by full-surface actuation, it will make a distinction between a brief press (less than 1 s), a sustained press (longer than 5 s) and an invalid key-press (between 1 s and 5 s) A brief press recalls the scene, a sustained press stores a scene and an invalid full-surface actuation is ignored.</p> <p>Visible only if "Full-surface actuation = enabled"!</p>

Command with full-surface actuation	ON OFF TOGGLE	This parameter defines the value of the transmitted telegram a full-surface actuation has been sensed. "TOGGLE" switches over the current object value. Visible only if "Function with full-surface actuation = Switching"!
Scene number (1 ... 64)	1, 2, ..., 64	This parameter defines the scene number which is to be transmitted to the bus after a scene recall or during storage of a scene. Visible only if "Function with full-surface actuation = Scene recall"!
If the function of the rocker = "Shutter"		
Function of status LED at the top	always OFF always ON key-press indicator status indicator (LED object) inverted status indicator (LED object) operating mode indicator (KNX controller) controller status indicator (activate controller extension!) comparator without sign (1 byte) comparator with sign (1 byte)	With a shutter function the status LED can... <ul style="list-style-type: none"> • be permanently on or off independent of the communication objects, • signal a key-press, • signal a state of the controller extension, • perform a comparison, • show the state of the own LED object. Depending on this setting, the ETS may also display further LED parameters.
Function of status LED at the bottom	always OFF always ON key-press indicator status indicator (LED object) inverted status indicator (LED object) operating mode indicator (KNX controller) controller status indicator (activate controller extension!) comparator without sign (1 byte) comparator with sign (1 byte)	With a shutter function the status LED can... <ul style="list-style-type: none"> • be permanently on or off independent of the communication objects, • signal a key-press, • signal a state of the controller extension, • perform a comparison, • show the state of the own LED object. Depending on this setting, the ETS may also display further LED parameters.

<p>Command on pressing the rocker</p>	<p>rocker X.1: UP / rocker X.2: DOWN rocker X.1: DOWN / rocker X.2: UP rocker X.1: TOGGLE / rocker X.2: TOGGLE</p>	<p>This parameter defines the running direction of a drive after a key-press. If the setting is "TOGGLE", the direction is changed after each long-time command. If several pushbuttons are to control the same drive, the long-time objects of the pushbuttons must be interlinked for a correct change of the running direction.</p>
<p>Operation concept</p>	<p>short – long - short long – short: short – long - short long – short:</p>	<p>For shutter control, four different operation concepts can be selected. For these concepts, the ETS shows further parameters.</p>
<p>Time between short-time and long-time command rocker 1.1 (1 ... 3000 x 100 ms)</p>	<p>1 ... 4 ... 3000</p>	<p>This parameter sets the time after which the long-time operation will be evaluated on pressing the top (or left-hand) rocker.</p> <p>This parameter is not visible with "Operation concept = Long – Short"!</p>
<p>Time between short-time and long-time command rocker 1.2 (1 ... 3000 x 100 ms)</p>	<p>1 ... 4 ... 3000</p>	<p>This parameter sets the time after which the long-time operation will be evaluated on pressing the bottom (or right-hand) rocker.</p> <p>This parameter is not visible with "Operation concept = Long – Short"!</p>
<p>Slat adjustment time rocker 1.1 (0 ... 3000 x 100 ms)</p>	<p>0 ... 5 ... 3000</p>	<p>Time during which a transmitted MOVE telegram can be terminated by releasing the top (or left-hand) key of the rocker (STEP). This function serves to adjust the slats.</p> <p>This parameter is not visible with "Operation concept = Long – Short"!</p>
<p>Slat adjustment time rocker 1.2 (0 ... 3000 x 100 ms)</p>	<p>0 ... 5 ... 3000</p>	<p>Time during which a transmitted MOVE telegram can be terminated by releasing the bottom (or right-hand) key of the rocker (STEP). This function serves to adjust the slats.</p> <p>This parameter is not visible with "Operation concept = Long – Short"!</p>

Full-surface actuation	enabled disabled	When full-surface actuation is enabled, the ETS shows the following parameters.
Function in case of full-surface actuation	switching scene recall without storage function scene recall with storage function	Full-surface actuation can only be programmed if "Operation concept = Long – Short or Short"! In case of full-surface operation, this parameter defines the function that is to be used. The ETS shows the corresponding communication object and the other parameters. If the pushbutton sensor is to recall a scene with storage function by full-surface actuation, it will make a distinction between a brief press (less than 1 s), a sustained press (longer than 5 s) and an invalid key-press (between 1 s and 5 s) A brief press recalls the scene, a sustained press stores a scene and an invalid full-surface actuation is ignored. Visible only if "Full-surface actuation = enabled"!
Command with full-surface actuation	ON OFF TOGGLE	This parameter defines the value of the transmitted telegram a full-surface actuation has been sensed. "TOGGLE" switches over the current object value. Visible only if "Function with full-surface actuation = Switching"!
Scene number (1 ... 64)	1, 2, ..., 64	This parameter defines the scene number which is to be transmitted to the bus after a scene recall or during storage of a scene. Visible only if "Function with full-surface actuation = Scene recall"!

If the function of the rocker = "Value transmitter 1 byte"		
Function of status LED at the top	always off always ON key-press indicator status indicator (LED object) inverted status indicator (LED object) operating mode indicator (KNX controller) controller status indicator (activate controller extension!) comparator without sign (1 byte) comparator with sign (1 byte)	With a value transmitter function the status LED can... <ul style="list-style-type: none"> • be permanently on or off independent of the communication objects, • signal a key-press, • signal a state of the controller extension, • perform a comparison, • show the state of the own LED object. Depending on this setting, the ETS may also display further LED parameters.
Function of status LED at the bottom	always off always ON key-press indicator status indicator (LED object) inverted status indicator (LED object) operating mode indicator (KNX controller) controller status indicator (activate controller extension!) comparator without sign (1 byte) comparator with sign (1 byte)	With a value transmitter function the status LED can... <ul style="list-style-type: none"> • be permanently on or off independent of the communication objects, • signal a key-press, • signal a state of the controller extension, • perform a comparison, • show the state of the own LED object. Depending on this setting, the ETS may also display further LED parameters.
Functionality	rocker X.1 / X.2 no function rocker X.1: 0 ... 255 / rocker X.2: 0 ... 255 rocker X.1: 0 ... 100 % / rocker X.2: 0 ... 100 % rocker X.1: 0 ... 255 / rocker X.2: no function rocker X.1: 0 ... 100 % / rocker X.2: no function rocker X.1: no function / rocker X.2: 0 ... 255 rocker X.1: no function / rocker X.2: 0 ... 100 %	A rocker parameterized as "Value transmitter 1 byte" permits selecting whether the values to be transmitted are interpreted as integers from 0 to 255 or as a percentage from 0 % to 100 % The following parameters and their settings depend on this distinction.

<p>Value rocker 1.1 (0 ... 255)</p>	<p>0 ... 255</p>	<p>Depending on the "Key arrangement" parameter, this parameter defines the object value, when the top (or left-hand) rocker is pressed.</p> <p>Visible only if "Functionality = ... 0...255"!</p>
<p>Value rocker 1.2 (0 ... 255)</p>	<p>0 ... 255</p>	<p>Depending on the "Key arrangement" parameter, this parameter defines the object value, when the bottom (or right-hand) rocker is pressed.</p> <p>Visible only if "Functionality = ... 0...255"!</p>
<p>Value rocker 1.1 (0 ... 100 %)</p>	<p>0 ... 100</p>	<p>Depending on the "Key arrangement" parameter, this parameter defines the object value, when the top (or left-hand) rocker is pressed.</p> <p>Visible only if "Functionality = ... 0...100 %"!</p>
<p>Value rocker 1.2 (0 ... 100 %)</p>	<p>0 ... 100</p>	<p>Depending on the "Key arrangement" parameter, this parameter defines the object value, when the top (or left-hand) rocker is pressed.</p> <p>Visible only if "Functionality = ... 0...100 %"!</p>
<p>Value adjustment via a long key press</p>	<p>enabled disabled</p>	<p>If value variation by long key-press is enabled, the ETS shows further parameters. Value variation begins, when the key is being held down for more than 5 s. In this case, the respective status LED blinks as a sign that a new telegram has been transmitted.</p>
<p>Starting value in case of value variation</p>	<p>same as parameterized value</p> <p>same as value after last variation</p> <p>same as value from communication object</p>	<p>Value variation can begin with different starting values.</p> <p>After each long press, the pushbutton sensor always starts with the value parameterized in the ETS.</p> <p>After a long press, the pushbutton sensor starts with the value transmitted by itself as the last value.</p> <p>After a long press, the pushbutton sensor starts with the value transmitted by itself or by another device with this group address as the last value.</p> <p>Visible only if "Value variation by long key-press = enabled"!</p>

Direction of value variation	upwards downwards toggle (alternating)	<p>With a long press, the pushbutton sensor can either vary the values always in the same direction or it stores the direction of the last variation and reverses it on the next key-press.</p> <p>Visible only if "Value variation by long key-press = enabled"!</p>
Step size (1 ... 15)	1 ... 15	<p>In a value variation, the pushbutton sensor determines the new telegram value from the previous value and the preset step size. If the value falls below the lower limit of the variation range (0 or 0 %) or if it exceeds the upper limit (255 or 100%), the sensor adapts the step size of the last step automatically.</p> <p>Visible only if "Value variation by long key-press = enabled"!</p>
Time between two telegrams	0.5 s 1 s 2 s 3 s	<p>This parameter defines the interval at which the pushbutton sensor transmits new telegrams during a value variation.</p> <p>Visible only if "Value variation by long key-press = enabled"!</p>
Value variation with overflow	yes no	<p>If value variation is to be effected without overflow (setting "No") and if the pushbutton sensor reaches the lower limit of the variation range (0 or 0 %) or the upper limit (255 or 100 %) during value variation, the variation will be stopped automatically by the sensor.</p> <p>If the value variation with overflow is programmed (setting "Yes") and if the pushbutton sensor reaches the lower or the upper limit, it will transmit the value of this range limit and then add a pause the duration of which corresponds to two steps. Thereafter, the pushbutton sensor transmits a telegram with the value of the other range limits and continues the value variation in the same direction.</p> <p>Visible only if "Value variation by long key-press = enabled"!</p>

If the function of the rocker = "Value transmitter 2 bytes"		
Function of status LED at the top	always OFF always ON key-press indicator status indicator (LED object) inverted status indicator (LED object) operating mode indicator (KNX controller) controller status indicator (activate controller extension!) comparator without sign (1 byte) comparator with sign (1 byte)	With a value transmitter function the status LED can... <ul style="list-style-type: none"> • be permanently on or off independent of the communication objects, • signal a key-press, • signal a state of the controller extension, • perform a comparison, • show the state of the own LED object. Depending on this setting, the ETS may also display further LED parameters.
Function of status LED at the bottom	always OFF always ON key-press indicator status indicator (LED object) inverted status indicator (LED object) operating mode indicator (KNX controller) controller status indicator (activate controller extension!) comparator without sign (1 byte) comparator with sign (1 byte)	With a value transmitter function the status LED can... <ul style="list-style-type: none"> • be permanently on or off independent of the communication objects, • signal a key-press, • signal a state of the controller extension, • perform a comparison, • show the state of the own LED object. Depending on this setting, the ETS may also display further LED parameters.
Functionality	temperature value transmitter brightness value transmitter value transmitter (0 ... 65535)	A rocker parameterized as "Value transmitter 1 byte" permits selecting whether the values to be transmitted are to be interpreted as temperature values (0 °C to 40 °C), as brightness values (0 lux to 1500 lux) or as integers (0 to 65535). The following parameters and their settings depend on this selection.
Temperature value (0 ... 40 °C) rocker 1.1	0 ... 20 ... 40	Depending on the "Key arrangement" parameter, this parameter defines the object value, when the top (or left-hand) rocker is pressed. Visible only if "Functionality = Temperature value transmitter"!
Temperature value (0 ... 40 °C) rocker 1.2	0 ... 20 ... 40	Depending on the "Key arrangement" parameter, this parameter defines the object value, when the bottom (or right-hand) rocker is pressed. Visible only if "Functionality = Temperature value transmitter"!

Brightness value rocker 1.1	0, 50, ... 300 ... 1450, 1500 lux	<p>Depending on the "Key arrangement" parameter, this parameter defines the object value, when the top (or left-hand) rocker is pressed.</p> <p>Visible only if "Functionality = Brightness value transmitter"!</p>
Brightness value rocker 1.2	0, 50, ... 300 ... 1450, 1500 lux	<p>Depending on the "Key arrangement" parameter, this parameter defines the object value, when the bottom (or right-hand) rocker is pressed.</p> <p>Visible only if "Functionality = Brightness value transmitter"!</p>
Value (0 ... 65535) rocker 1.1	0 ... 65535	<p>Depending on the "Key arrangement" parameter, this parameter defines the object value, when the top (or left-hand) rocker is pressed.</p> <p>Visible only if "Functionality = Value transmitter (0 ... 65535)"!</p>
Value (0 ... 65535) rocker 1.2	0 ... 65535	<p>Depending on the "Key arrangement" parameter, this parameter defines the object value, when the bottom (or right-hand) rocker is pressed.</p> <p>Visible only if "Functionality = Value transmitter (0 ... 65535)"!</p>
Value variation by long key-press	enabled disabled	<p>If value variation by long key-press is enabled, the ETS shows further parameters. Value variation begins, when the key is being held down for more than 5 s. In this case, the respective status LED blinks as a sign that a new telegram has been transmitted.</p>

Starting value for value variation	<p>same as parameterized value</p> <p>same as value after last variation</p> <p>same as value from communication object</p>	<p>Value variation can begin with different starting values.</p> <p>After each long press, the pushbutton sensor always starts with the value parameterized in the ETS.</p> <p>After a long press, the pushbutton sensor starts with the value transmitted by itself as the last value.</p> <p>After a long press, the pushbutton sensor starts with the value transmitted by itself or by another device with this group address as the last value. *</p> <p>Visible only if "Value variation by long key-press = enabled"!</p> <p>*: This setting selectable only if "Functionality = Value transmitter (0...65535)!"</p>
Direction of value variation	<p>upwards</p> <p>downwards</p> <p>toggle (alternating)</p>	<p>With a long press, the pushbutton sensor can either vary the values always in the same direction or it stores the direction of the last variation and reverses it on the next key-press.</p> <p>Visible only if "Value variation by long key-press = enabled"!</p>
Step size	<p>1 °C</p>	<p>For temperature values, the step size of the variation is fixed to 1°C.</p> <p>Visible only if "Functionality = Temperature value transmitter" and "Value variation by long key-press = enabled"!</p>
Step size	<p>50 lux</p>	<p>For brightness values, the step size of the variation is fixed to 50 lux.</p> <p>Visible only if "Functionality = Brightness value transmitter" and "Value variation by long key-press = enabled"!</p>
Step size	<p>1</p> <p>2</p> <p>5</p> <p>10</p> <p>20</p> <p>50</p> <p>75</p> <p>100</p> <p>200</p> <p>500</p> <p>750</p> <p>1000</p>	<p>This parameter sets the step size of the value variation for the 2-byte value transmitter.</p> <p>Visible only if "Functionality = Temperature value transmitter" and "Value variation by long key-press = enabled"!</p>

<p>Time between two telegrams</p> <p>Value variation with overflow</p>	<p>0.5 sec 1 s 2 s 3 s</p> <p>yes no</p>	<p>This parameter defines the interval at which the pushbutton sensor transmits new telegrams during a value variation.</p> <p>Visible only if "Value variation by long key-press = enabled"!</p> <p>If value variation is to be effected without overflow (setting "No") and if the pushbutton sensor reaches the lower limit of the variation range (0°C, 0 lux, 0) or the upper limit (+40°C, 1500 lux, 65535) during value variation, the variation will be stopped automatically by the sensor.</p> <p>If the value variation with overflow is programmed (setting "Yes") and if the pushbutton sensor reaches the lower or the upper limit, it will transmit the value of this range limit and then add a pause the duration of which corresponds to two steps. Thereafter, the pushbutton sensor transmits a telegram with the value of the other range limits and continues the value variation in the same direction.</p>
<p>If the function of the rocker = "Scene extension"</p>		
<p>Function of status LED at the top</p> <p>Function of status LED at the bottom</p>	<p>always OFF always ON key-press indicator status indicator (LED object) inverted status indicator (LED object) operating mode indicator (KNX controller) controller status indicator (activate controller extension!) comparator without sign (1 byte) comparator with sign (1 byte)</p> <p>always OFF always ON key-press indicator status indicator (LED object) inverted status indicator (LED object) operating mode indicator (KNX controller) controller status indicator (activate controller extension!) comparator without sign (1 byte) comparator with sign (1 byte)</p>	<p>With a scene extension function the status LED can...</p> <ul style="list-style-type: none"> • be permanently on or off independent of the communication objects, • signal a key-press, • signal a state of the controller extension, • perform a comparison, • show the state of the own LED object. <p>Depending on this setting, the ETS may also display further LED parameters.</p> <p>With a scene extension function the status LED can...</p> <ul style="list-style-type: none"> • be permanently on or off independent of the communication objects, • signal a key-press, • signal a state of the controller extension, • perform a comparison, • show the state of the own LED object. <p>Depending on this setting, the ETS may also display further LED parameters.</p>

Functionality	<p>scene extension without storage function scene extension with storage function Recall of internal scene without storage function Recall of internal scene with storage function</p>	<p>This parameter defines the functionality of the extension. If the pushbutton sensor is used as scene extension, the scenes can either be stored in one or in several other KNX/EIB devices (e.g. light scene pushbutton sensor). during a scene recall or in a storage function, the pushbutton sensor transmits a telegram with the respective scene number via the extension object of the rocker. During the recall of an internal scene, a scene stored internally in the pushbutton sensor Universal TSM is recalled or stored again. In this case, the sensor transmits no telegram to the bus via a scene extension object. For this setting, the internal scene function must be enabled.</p>
Scene number (1 ... 64) rocker 1.1	1 ... 64	<p>In accordance with the KNX standard, objects with data type 18.001 "Scene Control" can recall or store up to 64 scenes by their numbers. The parameter defines the scene number to be transmitted when the top (or left) of the key is pressed.</p>
Scene number (1 ... 64) rocker 1.2	1 ... 64	<p>In accordance with the KNX standard, objects with data type 18.001 "Scene Control" can recall or store up to 64 scenes by their numbers. The parameter defines the scene number to be transmitted when the bottom (or right) of the key is pressed.</p>
Scene number (1 ... 8) rocker 1.1	1 ... 8	<p>This parameter defines the number of the internal scene which is recalled or stored when the top (or left) of the key is pressed.</p>
Scene number (1 ... 8) rocker 1.2	1 ... 8	<p>This parameter defines the number of the internal scene which is recalled or stored when the bottom (or right) of the key is pressed.</p>

If the function of the rocker = "2-channel operation"		
Function of status LED at the top	always OFF always ON telegram acknowledge status indicator (LED object) inverted status indicator (LED object) operating mode indicator (KNX controller) controller status indicator (activate controller extension!) comparator without sign (1 byte) comparator with sign (1 byte)	With a 2-channel function, the status LED can... <ul style="list-style-type: none"> • be permanently on or off independent of the communication objects, • indicate whether a telegram has been transmitted, • signal a state of the controller extension, • perform a comparison, • show the state of the own LED object. Depending on this setting, the ETS may also display further LED parameters.
Function of status LED at the bottom	always OFF always ON telegram acknowledge status indicator (LED object) inverted status indicator (LED object) operating mode indicator (KNX controller) controller status indicator (activate controller extension!) comparator without sign (1 byte) comparator with sign (1 byte)	With a 2-channel function, the status LED can... <ul style="list-style-type: none"> • be permanently on or off independent of the communication objects, • indicate whether a telegram has been transmitted, • signal a state of the controller extension, • perform a comparison, • show the state of the own LED object. Depending on this setting, the ETS may also display further LED parameters.
Operation concept	channel 1 or channel 2 channel 1 and channel 2	This parameter defines the 2-channel operation concept. If the setting "Channel 1 or channel 2" is selected, the pushbutton sensor decides dependent on the key-press duration which of the channels will be used. If the setting "Channel 1 and channel 2" is selected, the pushbutton sensor transmits only the telegram of channel 1 on a short key-press and both telegrams on a sustained key-press.

<p>Function channel 1 (2)</p>	<p>no function switching (1 bit) value transmitter 0 ... 255 (1 byte) value transmitter 0 ... 100 % (1 byte) temperature value transmitter (2 bytes)</p>	<p>This parameter defines the channel function and specifies which other parameters and which communication object are to be displayed for channel 1 (2).</p>
<p>Key command for channel 1 (2) rocker 1.1</p>	<p>ON OFF TOGGLE</p>	<p>This parameter defines the object value transmitted to the bus, when the top (or left-hand) rocker is pressed.</p> <p>Visible only if "Function channel 1 (2) = Switching (1 bit)"!</p>
<p>Key command for channel 1 (2) rocker 1.2</p>	<p>ON OFF TOGGLE</p>	<p>This parameter defines the object value transmitted to the bus, when the bottom (or right-hand) rocker is pressed.</p> <p>Visible only if "Function channel 1 (2) = Switching (1 bit)"!</p>
<p>Value of key for channel 1 (2) rocker 1.1 (0 ... 255)</p>	<p>0 ... 255</p>	<p>This parameter defines the object value transmitted to the bus, when the top (or left-hand) rocker is pressed.</p> <p>Visible only if "Function channel 1 (2) = Value transmitter 0...255 (1 byte)"!</p>
<p>Value of key for channel 1 (2) rocker 1.2 (0 ... 255)</p>	<p>0 ... 255</p>	<p>This parameter defines the object value transmitted to the bus, when the bottom (or right-hand) rocker is pressed.</p> <p>Visible only if "Function channel 1 (2) = Value transmitter 0...255 (1 byte)"!</p>
<p>Value of key for channel 1 (2) rocker 1.1 (0 ... 100 %)</p>	<p>0 ... 100</p>	<p>This parameter defines the object value transmitted to the bus, when the top (or left-hand) rocker is pressed.</p> <p>Visible only if "Function channel 1 (2) = Value transmitter 0...100 % (1 byte)"!</p>
<p>Value of key for channel 1 (2) rocker 1.2 (0 ... 100 %)</p>	<p>0 ... 100</p>	<p>This parameter defines the object value transmitted to the bus, when the bottom (or right-hand) rocker is pressed.</p> <p>Visible only if "Function channel 1 (2) = Value transmitter 0...100 % (1 byte)"!</p>

Temperature value of key for channel 1 (2) rocker 1.1 (0 ... 40 °C)	0 ... 40	This parameter defines the temperature value transmitted to the bus, when the top (or left-hand) rocker is pressed. Visible only if "Function channel 1 (2) = Temperature value transmitter (2 bytes)"!
Temperature value of key for channel 1 (2) rocker 1.2 (0 ... 40 °C)	0 ... 40	This parameter defines the temperature value transmitted to the bus, when the bottom (or right-hand) rocker is pressed. Visible only if "Function channel 1 (2) = Temperature value transmitter (2 bytes)"!
Time between channel 1 and channel 2 rocker 1.1 (1 ... 255 x 100 ms)	0 ... 30 ... 255	Depending on the selected operation concept, this parameter defines the interval at which the sensor transmits the telegram for channel 1 and the telegram for channel 2 when the top (or left side) of the rocker is pressed.
Time between channel 1 and channel 2 rocker 1.2 (1 ... 255 x 100 ms)	0 ... 30 ... 255	Depending on the selected operation concept, this parameter defines the interval at which the sensor transmits the telegram for channel 1 and the telegram for channel 2 if the bottom (or right side) of the rocker is pressed.
Full-surface actuation	enabled disabled	When full-surface actuation is enabled, the ETS shows the following parameters. Full-surface actuation can only be programmed if "Operation concept = Channel 1 or channel 2"!
Function in case of full-surface actuation	switching scene recall without storage function scene recall with storage function	In case of full-surface operation, this parameter defines the function that is to be used. The ETS shows the corresponding communication object and the other parameters. If the pushbutton sensor is to recall a scene with storage function by full-surface actuation, it will make a distinction between a brief press (less than 1 s), a sustained press (longer than 5 s) and an invalid key-press (between 1 s and 5 s) A brief press recalls the scene, a sustained press stores a scene and an invalid full-surface actuation is ignored. Visible only if "Full-surface actuation = enabled"!

Command with full-surface actuation	ON OFF TOGGLE	This parameter defines the value of the transmitted telegram a full-surface actuation has been sensed. "TOGGLE" switches over the current object value. Visible only if "Function with full-surface actuation = Switching"!
Scene number (1 ... 64)	1, 2, ..., 64	This parameter defines the scene number which is to be transmitted to the bus after a scene recall or during storage of a scene. Visible only if "Function with full-surface actuation = Scene recall"!
<input type="checkbox"/> Rockers 2 ... max. 8 see rocker 1!		
<input type="checkbox"/> Key 1 (only if "Function of keys 1 and 2 = as separate keys")		
Function	no function switching dimming blind/shutter Value transmitter 1 byte Value transmitter 2 bytes scene extension 2-channel operation controller extension (enable under "General")	This parameter defines the basic function of the key. Depending on this setting, the ETS displays different communication objects and parameters for this key.
<p>The status LEDs of a key can be programmed for independent LED functions which have no relationship with the basic function of the key. This always results in the LED parameters described below...</p> <p>If the function of the status LED = "Operating mode indicator (KNX controller)"</p>		
Status LED ON with	automatic mode comfort operation standby operation night-time operation frost /heat protection	The values of a communication object with data type 20.102 "HVAC Mode" are defined as follows: 0 = automatic 1 = comfort 2 = standby 3 = night 4 = frost/heat protection The value "automatic" is used only by the "forced operating mode switch-over" objects. The status LED is on when the object adopts the parameterized value.

If the function of the status LED = "Controller status indicator"		
Status LED ON with	comfort operation standby operation night-time operation frost /heat protection controller disabled heating / cooling: controller inactive (dead zone operation) frost alarm	The "Controller status" communication object of the controller extension function includes eight bits of information in one byte. This parameter defines which bit is to be indicated by the LED. The controller status can be displayed only if the controller extension is enabled (parameter page "General")!
If the function of the status LED = "Comparator without sign"		
Status LED ON with	reference value greater than received value reference value less than received value reference value equal to received value	The status LED indicates whether the parameterized reference value is greater or less than or equal to the value of the "Status LED" object.
Reference value (0 ... 255)	0 ... 255	This parameter defines the reference value to which the value of the "Status LED" object is compared.
If the function of the status LED = "Comparator with sign"		
Status LED ON with	reference value greater than received value reference value less than received value reference value equal to received value	The status LED indicates whether the parameterized reference value is greater or less than or equal to the value of the "Status LED" object.
Reference value (-128 ... 127)	-128 ... 0 ... 127	This parameter defines the reference value to which the value of the "Status LED" object is compared.
Function of the key = "No function"		
Function of status LED	always OFF always ON status indicator (LED object) inverted status indicator (LED object) operating mode indicator (KNX controller) controller status indicator (activate controller extension!) comparator without sign (1 byte) comparator with sign (1 byte)	When the rocker is not used, the status LED can ... <ul style="list-style-type: none"> • be permanently on or off independent of the communication objects, • signal a state of the controller extension, • perform a comparison, • show the state of the own LED object. Depending on this setting, the ETS may also display further LED parameters.

If the function of the rocker = "Switching"		
Function of status LED	always OFF always ON key-press indicator status indicator (switching object) inverted status indicator (switching object) status indicator (LED object) inverted status indicator (LED object) operating mode indicator (KNX controller) controller status indicator (activate controller extension!) comparator without sign (1 byte) comparator with sign (1 byte)	With a switching function the status LED can... <ul style="list-style-type: none"> • be permanently on or off independent of the communication objects, • signal a key-press, • signal the state of the communication object "Switching" • signal a state of the controller extension, • perform a comparison, • show the state of the own LED object. Depending on this setting, the ETS may also display further LED parameters.
Command on pressing the key	no reaction ON OFF TOGGLE	Depending on the "Key arrangement" parameter, these parameters define the reaction taking place when the key is pressed or released.
Command on releasing the key	no reaction ON OFF TOGGLE	
Function of key = "Dimming"		
Function of status LED	always OFF always ON key-press indicator status indicator (switching object) inverted status indicator (switching object) status indicator (LED object) inverted status indicator (LED object) operating mode indicator (KNX controller) controller status indicator (activate controller extension!) comparator without sign (1 byte) comparator with sign (1 byte)	With a dimming function the status LED can... <ul style="list-style-type: none"> • be permanently on or off independent of the communication objects, • signal a key-press, • signal the state of the communication object "Switching" • signal a state of the controller extension, • perform a comparison, • show the state of the own LED object. Depending on this setting, the ETS may also display further LED parameters.

Command on pressing the key	no reaction brighter (ON) darker (OFF) brighter / darker (TOGGLE) brighter (TOGGLE) darker (TOGGLE)	This parameter defines the reaction when the key is pressed. If the pushbutton sensor is to toggle on a brief press, the corresponding switching objects of other sensors with the same function must be linked with one another. In the "Brighter/darker (TOGGLE)" setting, the dimming objects must be interlinked as well so that the pushbutton sensor can send the correct telegram on the next key-press.
Time between switching and dimming (100 ... 50000 x 1 ms)	100 ... 400 ... 50000	This parameter defines how long the key must be pressed for the pushbutton sensor to send a dimming telegram.
Advanced parameters	activated deactivated	When the advanced parameters are activated, the ETS shows the following parameters.
Advanced parameters activated...		
Increase brightness by	1.5 % 3 % 6 % 12.5 % 25 % 50 % 100 %	This parameter sets the relative dimming step when the brightness is increased. On each key-press, the brightness is changed at maximum by the parameterized step Especially with smaller dimming steps it is recommended that the pushbutton sensor repeats the dimming telegrams automatically (cf. "Telegram repetition").
Reduce brightness by	1.5 % 3 % 6 % 12.5 % 25 % 50 % 100 %	This parameter sets the relative dimming step when the brightness is reduced. On each key-press, the brightness is changed at maximum by the parameterized step Especially with smaller dimming steps it is recommended that the pushbutton sensor repeats the dimming telegrams automatically (cf. "Telegram repetition").
Transmit stop telegram ?	yes no	For "Yes" the pushbutton sensor transmits a telegram for stopping the dimming process when the key is released. When the pushbutton sensor transmits telegrams for dimming in smaller steps, the stop telegram is generally not needed.

Telegram repetition?	yes no	This parameter can be used to activate telegram repetition for dimming. With the key held down, the pushbutton sensor will then transmit the relative dimming telegrams (in the programmed step width) until the key is released.
Time between two telegrams	200 ms 300 ms 400 ms 500 ms 750 ms 1 sec 2 sec	This parameter defines the interval at which the dimming telegrams are automatically repeated in the telegram repetition mode. Visible only if "Telegram repetition = Yes"!
Function of key = "Shutter"		
Function of status LED	always OFF always ON key-press indicator status indicator (LED object) inverted status indicator (LED object) operating mode indicator (KNX controller) controller status indicator (activate controller extension!) comparator without sign (1 byte) comparator with sign (1 byte)	With a shutter function the status LED can... <ul style="list-style-type: none"> • be permanently on or off independent of the communication objects, • signal a key-press, • signal a state of the controller extension, • perform a comparison, • show the state of the own LED object. <p>Depending on this setting, the ETS may also display further LED parameters.</p>
Command on pressing the key	DOWN UP TOGGLE	This parameter defines the running direction of a drive after a key-press. If the setting is "TOGGLE", the direction is changed after each long-time command. If several pushbuttons are to control the same drive, the long-time objects of the pushbuttons must be interlinked for a correct change of the running direction.

<p>Operation concept</p> <p>Time between short-time and long-time command (1 ... 3000 x 100 ms)</p> <p>Slat adjustment time (0 ... 3000 x 100 ms)</p>	<p>short – long - short long – short: short – long - short long – short:</p> <p>1 ... 4 ... 3000</p> <p>0 ... 5 ... 3000</p>	<p>For shutter control, four different operation concepts can be selected. For these concepts, the ETS shows further parameters.</p> <p>This parameter sets the time after which the long-time operation will be evaluated on pressing the key.</p> <p>This parameter is not visible with "Operation concept = Long – Short"!</p> <p>Time during which a transmitted MOVE telegram can be terminated by releasing the key (STEP). This function serves to adjust the slats of a blind.</p> <p>This parameter is not visible with "Operation concept = Long – Short"!</p>
<p>If function of the key = "Value transmitter 1 byte"</p>		
<p>Function of status LED</p> <p>Functionality</p>	<p>always OFF always ON key-press indicator status indicator (LED object) inverted status indicator (LED object) operating mode indicator (KNX controller) controller status indicator (activate controller extension!) comparator without sign (1 byte) comparator with sign (1 byte)</p> <p>value transmitter 0 ... 255 value transmitter 0 ... 100 %</p>	<p>With a value transmitter function the status LED can...</p> <ul style="list-style-type: none"> • be permanently on or off independent of the communication objects, • signal a key-press, • signal a state of the controller extension, • perform a comparison, • show the state of the own LED object. <p>Depending on this setting, the ETS may also display further LED parameters.</p> <p>A key parameterized as "Value transmitter 1 byte" permits selecting whether the values to be transmitted are interpreted as integers from 0 to 255 or as a percentage from 0 % to 100 %. The following parameters and their settings depend on this distinction.</p>

Value (0 ... 255)	0 ... 255	<p>This parameter defines the object value, when the key is pressed.</p> <p>Visible only if "Functionality = ... 0...255"!</p>
Value (0 ... 100 %)	0 ... 100	<p>This parameter defines the object value, when the key is pressed.</p> <p>Visible only if "Functionality = ... 0...100 %"!</p>
Value variation by long key-press	<p>enabled disabled</p>	<p>If value variation by long key-press is enabled, the ETS shows further parameters. Value variation begins, when the key is being held down for more than 5 s. In this case, the respective status LED blinks as a sign that a new telegram has been transmitted.</p>
Starting value for value variation	<p>same as parameterized value</p> <p>same as value after last variation</p> <p>same as value from communication object</p>	<p>Value variation can begin with different starting values.</p> <p>After each long press, the pushbutton sensor always starts with the value parameterized in the ETS.</p> <p>After a long press, the pushbutton sensor starts with the value transmitted by itself as the last value.</p> <p>After a long press, the pushbutton sensor starts with the value transmitted by itself or by another device with this group address as the last value.</p> <p>Visible only if "Value variation by long key-press = enabled"!</p>

Direction of value variation	upwards downwards toggle (alternating)	<p>With a long press, the pushbutton sensor can either vary the values always in the same direction or it stores the direction of the last variation and reverses it on the next key-press.</p> <p>Visible only if "Value variation by long key-press = enabled"!</p>
Step size (1 ... 15)	1 ... 15	<p>In a value variation, the pushbutton sensor determines the new telegram value from the previous value and the preset step width. If the value falls below the lower limit of the variation range (0 or 0 %) or if it exceeds the upper limit (255 or 100%), the sensor adapts the step width of the last step automatically.</p> <p>Visible only if "Value variation by long key-press = enabled"!</p>
Time between two telegrams	0.5 s 1 s 2 s 3 s	<p>This parameter defines the interval at which the pushbutton sensor transmits new telegrams during a value variation.</p> <p>Visible only if "Value variation by long key-press = enabled"!</p>
Value variation with overflow	yes no	<p>If value variation is to be effected without overflow (setting "No") and if the pushbutton sensor reaches the lower limit of the variation range (0 or 0 %) or the upper limit (255 or 100 %) during value variation, the variation will be stopped automatically by the sensor.</p> <p>If the value variation with overflow is programmed (setting "Yes") and if the pushbutton sensor reaches the lower or the upper limit, it will transmit the value of this range limit and then add a pause the duration of which corresponds to two steps. Thereafter, the pushbutton sensor transmits a telegram with the value of the other range limits and continues the value variation in the same direction.</p> <p>Visible only if "Value variation by long key-press = enabled"!</p>

If function of the key = "Value transmitter 2 bytes"		
Function of status LED	always OFF always ON key-press indicator status indicator (LED object) inverted status indicator (LED object) operating mode indicator (KNX controller) controller status indicator (activate controller extension!) comparator without sign (1 byte) comparator with sign (1 byte)	With a value transmitter function the status LED can... <ul style="list-style-type: none"> • be permanently on or off independent of the communication objects, • signal a key-press, • signal a state of the controller extension, • perform a comparison, • show the state of the own LED object. Depending on this setting, the ETS may also display further LED parameters.
Functionality	temperature value transmitter brightness value transmitter value transmitter (0 ... 65535)	A key parameterized as "Value transmitter 1 byte" permits selecting whether the values to be transmitted are to be interpreted as temperature values (0 °C to 40 °C), as brightness values (0 lux to 1500 lux) or as integers (0 to 65535). The following parameters and their settings depend on this distinction.
Temperature value (0 ... 40 °C)	0 ... 20 ... 40	This parameter defines the object value, when the key is pressed. Visible only if "Functionality = Temperature value transmitter"!
Brightness value	0, 50, ... 300 ... 1450, 1500 lux	This parameter defines the object value, when the key is pressed. Visible only if "Functionality = Brightness value transmitter"!
Value (0 ... 65535)	0 ... 65535	This parameter defines the object value, when the key is pressed. Visible only if "Functionality = Value transmitter (0 ... 65535)"!

<p>Value variation by long key-press</p> <p>Starting value for value variation</p>	<p>enabled disabled</p> <p>same as parameterized value</p> <p>same as value after last variation</p> <p>same as value from communication object</p>	<p>If value variation by long key-press is enabled, the ETS shows further parameters. Value variation begins, when the key is being held down for more than 5 s. In this case, the respective status LED blinks as a sign that a new telegram has been transmitted.</p> <p>Value variation can begin with different starting values.</p> <p>After each long press, the pushbutton sensor always starts with the value parameterized in the ETS.</p> <p>After a long press, the pushbutton sensor starts with the value transmitted by itself as the last value.</p> <p>After a long press, the pushbutton sensor starts with the value transmitted by itself or by another device with this group address as the last value. *</p> <p>Visible only if "Value variation by long key-press = enabled"!</p> <p>*: This setting selectable only if "Functionality = Value transmitter (0...65535)!"</p>
<p>Direction of value variation</p>	<p>upwards downwards toggle (alternating)</p>	<p>With a long press, the pushbutton sensor can either vary the values always in the same direction or it stores the direction of the last variation and reverses it on the next key-press.</p> <p>Visible only if "Value variation by long key-press = enabled"!</p>
<p>Step size</p>	<p>1 °C</p>	<p>For temperature values, the step size of the variation is fixed to 1°C.</p> <p>Visible only if "Functionality = Temperature value transmitter" and "Value variation by long key-press = enabled"!</p>
<p>Step size</p>	<p>50 lux</p>	<p>For brightness values, the step size of the variation is fixed to 50 lux.</p> <p>Visible only if "Functionality = Brightness value transmitter" and "Value variation by long key-press = enabled"!</p>

Step size	<p>1 2 5 10 20 50 75 100 200 500 750 1000</p>	<p>This parameter sets the step size of the value variation for the 2-byte value transmitter.</p> <p>Visible only if "Functionality = Temperature value transmitter" and "Value variation by long key-press = enabled"!</p>
Time between two telegrams	<p>0.5 s 1 s 2 s 3 s</p>	<p>This parameter defines the interval at which the pushbutton sensor transmits new telegrams during a value variation.</p> <p>Visible only if "Value variation by long key-press = enabled"!</p>
Value variation with overflow	<p>yes no</p>	<p>If value variation is to be effected without overflow (setting "No") and if the pushbutton sensor reaches the lower limit of the variation range (0°C, 0 lux, 0) or the upper limit (+40°C, 1500 lux, 65535) during value variation, the variation will be stopped automatically by the sensor.</p> <p>If the value variation with overflow is programmed (setting "Yes") and if the pushbutton sensor reaches the lower or the upper limit, it will transmit the value of this range limit and then add a pause the duration of which corresponds to two steps. Thereafter, the pushbutton sensor transmits a telegram with the value of the other range limits and continues the value variation in the same direction.</p>
If the function of the rocker = "Scene extension"		
Function of status LED	<p>always OFF always ON key-press indicator status indicator (LED object) inverted status indicator (LED object) operating mode indicator (KNX controller) controller status indicator (activate controller extension!) comparator without sign (1 byte) comparator with sign (1 byte)</p>	<p>With a scene extension function the status LED can...</p> <ul style="list-style-type: none"> • be permanently on or off independent of the communication objects, • signal a key-press, • signal a state of the controller extension, • perform a comparison, • show the state of the own LED object. <p>Depending on this setting, the ETS may also display further LED parameters.</p>

<p>Functionality</p>	<p>scene extension without storage function scene extension with storage function Recall of internal scene without storage function Recall of internal scene with storage function</p>	<p>This parameter defines the functionality of the extension. If the pushbutton sensor is used as scene extension, the scenes can either be stored in one or in several other KNX/EIB devices (e.g. light scene pushbutton sensor). During a scene recall or in a storage function, the pushbutton sensor transmits a telegram with the respective scene number via the extension object of the rocker. During the recall of an internal scene, a scene stored internally in the pushbutton sensor Universal TSM is recalled or stored again. In this case, the sensor transmits no telegram to the bus via a scene extension object. For this setting, the internal scene function must be enabled.</p>
<p>Scene number (1 ... 64)</p>	<p>1 ... 64</p>	<p>In accordance with the KNX standard, objects with data type 18.001 "Scene Control" can recall or store up to 64 scenes by their numbers. The parameter defines the scene number to be transmitted when a key is pressed.</p>
<p>Scene number (1 ... 8)</p>	<p>1 ... 8</p>	<p>This parameter defines the number of the internal scene which is recalled or stored when a key is pressed.</p>

If the function of the rocker = "2-channel operation"		
Function of status LED	always OFF always ON telegram acknowledge status indicator (LED object) inverted status indicator (LED object) operating mode indicator (KNX controller) controller status indicator (activate controller extension!) comparator without sign (1 byte) comparator with sign (1 byte)	With a 2-channel function, the status LED can... <ul style="list-style-type: none"> • be permanently on or off independent of the communication objects, • indicate whether a telegram has been transmitted, • signal a state of the controller extension, • perform a comparison, • show the state of the own LED object. Depending on this setting, the ETS may also display further LED parameters.
Operation concept	channel 1 or channel 2 channel 1 and channel 2	This parameter defines the 2-channel operation concept. If the setting "Channel 1 or channel 2" is selected, the pushbutton sensor decides dependent on the key-press duration which of the channels will be used. If the setting "Channel 1 and channel 2" is selected, the pushbutton sensor transmits only the telegram of channel 1 on a short key-press and both telegrams on a sustained key-press.
Function channel 1 (2)	no function switching (1 bit) value transmitter 0 ... 255 (1 byte) value transmitter 0 ... 100 % (1 byte) temperature value transmitter (2 bytes)	This parameter defines the channel function and specifies which other parameters and which communication object are to be displayed for channel 1 (2).
Key command for channel 1 (2)	ON OFF TOGGLE	This parameter defines the object value transmitted to the bus, when the key is pressed. Visible only if "Function channel 1 (2) = Switching (1 bit)"!
Value of key for channel 1 (2) (0 ... 255)	0 ... 255	This parameter defines the object value transmitted to the bus, when the key is pressed. Visible only if "Function channel 1 (2) = Value transmitter 0...255 (1 byte)"!
Value of key for channel 1 (2) (0 ... 100 %)	0 ... 100	This parameter defines the object value transmitted to the bus, when the key is pressed. Visible only if "Function channel 1 (2) = Value transmitter 0...100 % (1 byte)"!

<p>Temperature value of key for channel 1 (2) (0 ... 40 °C)</p> <p>Time between channel 1 und channel 2 (1 ... 255 x 100 ms)</p>	<p>0 ... 40</p> <p>0 ... 30 ... 255</p>	<p>This parameter defines the temperature value transmitted to the bus, when the key is pressed.</p> <p>Visible only if "Function channel 1 (2) = Temperature value transmitter (2 bytes)"!</p> <p>Depending on the selected operation concept, this parameter defines the interval at which the sensor transmits the telegram for channel 1 and the telegram for channel 2 when the key is pressed.</p>
<p>Function of key = "Controller extension"</p>		
<p>Function of status LED</p> <p>Status LED</p>	<p>always OFF always ON key-press indicator status indicator (LED object) inverted status indicator (LED object) key function active indicator key function inactive indicator* Setpoint value shift indicator** operating mode indicator (KNX controller) controller status indicator (activate controller extension!) comparator without sign (1 byte) comparator with sign (1 byte)</p> <p>ON with variation ON with positive variation ON with negative variation OFF with variation OFF with positive variation OFF with negative variation</p>	<p>With a controller extension function the status LED can...</p> <ul style="list-style-type: none"> • be permanently on or off independent of the communication objects, • signal a key-press, • signal a state of the controller extension, • perform a comparison, • show the state of the own LED object. • signal the presence state (key function indication)* • indicate a setpoint value shift** <p>Depending on this setting, the ETS may also display further LED parameters.</p> <p>*: The key function indication can only be programmed with a presence key!</p> <p>** : The setpoint value shift can only be programmed, if the key functionality is set to "Setpoint value shift".</p> <p>With a setpoint shift indication, the illumination behaviour of the status LED can be adjusted.</p> <p>If the setting is "ON...", the status is on only in case of a variation. Otherwise, it is permanently off.</p> <p>If the setting is "OFF...", the status switches off in case of a variation. Otherwise, it is permanently on.</p> <p>One can also specify whether the status LED is to be switched whenever a variation occurs or only in case of a positive or alternatively a negative setpoint variation.</p> <p>Visible only if "Function of the status LED = Setpoint value shift indication"!</p>

Functionality	<p>operating mode switch-over forced operating mode switchover presence key setpoint value shift</p>	<p>A controller extension can optionally switch over the operating mode with normal or high priority, change the presence state or change the current room temperature value. With regard to the setting of this parameter, the ETS shows further parameters.</p>
Operating mode on pressing the key	<p>comfort operation standby mode night-time operation frost /heat protection comfort operation -> standby operation -> comfort operation -> night-time operation -> standby operation -> night-time operation -> comfort operation -> standby operation -> night-time operation -></p>	<p>If the controller extension is to switch over the operating mode of the room temperature controller with normal priority, the extension can – when actuated – either activate a defined mode of operation or change over between different modes of operation.</p> <p>In order for this change to work properly, the controller extension should request the current state of the extension objects after a reset or after reprogramming (set parameter under "General" to "Value request from controller extension = Yes"). Visible only if "Functionality = Operating mode switch-over"!</p>
Forced operating mode on pressing the key	<p>Auto (normal operating mode switch-over) comfort operation standby mode night-time operation frost /heat protection comfort operation -> standby operation -> comfort operation -> night-time operation -> standby operation -> night-time operation -> comfort operation -> standby operation -> night-time operation -> Auto -> comfort operation -> Auto -> standby operation -></p>	<p>If the controller extension is to switch over the operating mode of the room temperature controller with high priority, the extension can – when actuated – either enable the switch-over with normal priority (auto), switch on a defined mode of operation with a high priority or change over between different modes of operation.</p> <p>In order for this change to work properly, the controller extension should request the current state of the extension objects after a reset or after reprogramming (set parameter under "General" to "Value request from controller extension = Yes"). Visible only if "Functionality = Forced operating mode switch-over"!</p>

<p>Presence function on pressing the key</p>	<p>presence OFF presence ON presence TOGGLE</p>	<p>On pressing a key, the controller extension can switch the presence state of the room temperature controller either on or off in a defined way or change over between both states ("Presence TOGGLE"). In order for this change to work properly, the controller extension should request the current state of the extension objects after a reset or after reprogramming (set parameter under "General" to "Value request from controller extension = Yes").</p>
<p>Functionality "Setpoint shift"</p>		
<p>Setpoint shift on pressing the key</p>	<p>reduce setpoint value (step size) increase setpoint value (step size)</p>	<p>This parameter defines the direction of the setpoint shift. For a setpoint value shift, the controller extension makes use of the two communication objects "Output setpoint shift" and "Input setpoint shift". The "Input setpoint shift" communication object informs the extension about the current state of the room temperature controller. Based on this value and the respective parameter, the controller extension determines the new step size which it transmits via the "Output setpoint shift" communication object to the room temperature controller.</p>
<p><input type="checkbox"/> Keys 2 ... max. 16 see key 1!</p>		
<p><input type="checkbox"/> Room temperature measurement (only 8-gang)</p>		
<p>Temperature measurement by</p> <p>Determination of measured value from internal / external ratio</p>	<p>Internal sensor Internal and external sensor</p> <p>10 % to 90 % ... 50 % to 50 % ... 90% to 10 %</p>	<p>The room temperature measurement can work optionally only with the internal sensor or with a combination of internal and external sensor.</p> <p>In a combination consisting of internal and external sensor, the pushbutton sensor computes an average room temperature value from these sensors with selectable weighting.</p>

<p>Internal sensor adjustment -128 ... 127 * 0,1 K)</p>	<p style="text-align: center;">-128 ... 0 ... 127</p>	<p>This parameter can be used to correct measured value deviations of the internal temperature sensor, e.g. due to component tolerances.</p>
<p>External sensor adjustment -128 ... 127 * 0,1 K)</p>	<p style="text-align: center;">-128 ... 0 ... 127</p>	<p>This parameter can be used to correct measured value deviations of the external temperature sensor, e.g. due to component tolerances.</p> <p>Visible only if "Temperature measurement by internal and external sensor"!</p>
<p>Request time for external sensor (0 ... 255 * 1 minute) (0 = inactive)</p>	<p style="text-align: center;">0 ... 255</p>	<p>If the external sensor does not transmit its measured values automatically, the pushbutton sensor can request these values at regular intervals.</p> <p>Visible only if "Temperature measurement by internal and external sensor"!</p>
<p>Cyclical transmission of the room temperature (0 ... 255 * 1 minute) (0 = inactive)</p>	<p style="text-align: center;">0 ... 255</p>	<p>The pushbutton sensor transmit the measured and - if necessary - corrected value cyclically at regular intervals.</p> <p>The parameter set the cycle time. A setting of "0" deactivates cyclical transmission.</p>
<p>Transmission after room temperature change by (0 ... 255 * +/-0,1 K) (0 = inactive)</p>	<p style="text-align: center;">0 ... 255</p>	<p>The pushbutton sensor can transmit the measured and - if necessary - corrected value in case of deviation from the previous measured value.</p> <p>This parameter sets the room temperature change required for the sensor to detect a deviation from the previous measured value. A setting of "0" deactivates the automatic transmission in case of a room temperature change.</p>

<input type="checkbox"/> Disabling functions		
Disabling function?	yes no	With this parameter, the disabling function of the pushbutton sensor can be centrally activated. If "Yes", the ETS shows further communication object and parameters.
Disabling function active...		
Polarity of disabling object	disable = 1 / enable = 0 disable = 0 / enable = 1	This parameter defines the value of the disabling object at which the disabling function is active.
Reaction of pushbutton sensor at the beginning of the disabling function	no reaction reaction like key >>X<< when pressed reaction like key >>X<< when released reaction like disabling function 1 when pressed reaction like disabling function 1 when released reaction like disabling function 2 when pressed reaction like disabling function 2 when released internal scene recall scene 1 internal scene recall scene 2 internal scene recall scene 3 internal scene recall scene 4 internal scene recall scene 5 internal scene recall scene 6 internal scene recall scene 7 internal scene recall scene 8	Besides disabling of rocker and key functions, the pushbutton sensor can also and in addition trigger a specific function at the time of activation of the disabling state. This function can... <ul style="list-style-type: none"> • correspond to the function assigned to any of the keys in the non-disabled state ("Reaction like key >>X<< ..."), • be defined on the following parameter pages ("Reaction like disabling function ..."), • recall a scene stored internally in the pushbutton sensor ("Internal scene recall ...").
Key >>X<<	key 1 key 2 ... key 16 *	If the pushbutton sensor is to perform the function of a specific key at the beginning of the disabling state, this key will be selected here. Visible only if "Reaction of pushbutton sensor at the beginning of the disabling state = Reaction like key >>X<< on pressing / releasing of the key"!
Behaviour during active disabling	all keys without function. all keys behave like individual keys without function. individual keys behave like	While disabling is active... <ul style="list-style-type: none"> • all keys or only individually selected keys can be disabled ("... no function"), • all keys or only individually selected keys can be restricted to a specific function ("... behave like"), In this case, the ETS shows further parameters.

<p>All keys with even numbers behave during disabling like...</p>	<p>key 1 key 2 ... key 16 * disabling function 1 disabling function 2</p>	<p>If a specific key function is to be assigned during disabling to all or to individual keys, this parameter can be used to select the desired key the function of which will then be executed. During disabling, all keys with even numbers (2, 4, 6,...) behave like the one parameterized here. The desired functions can either correspond to the function of an existing key or they can be parameterized as special disabling functions.</p> <p>Visible only if "Behaviour during active disabling = all keys behave like" or "Behaviour during active disabling = individual keys behave like"!</p> <p>*: The number of keys depends on the projected pushbutton sensor variant!</p>
<p>All keys with odd numbers behave during disabling like...</p>	<p>key 1 key 2 ... key 16 * disabling function 1 disabling function 2</p>	<p>If a specific key function is to be assigned during disabling to all or to individual keys, this parameter can be used to select the desired key the function of which will then be executed. During disabling, all keys with odd numbers (1, 3, 5,...) behave like the one parameterized here. The desired functions can either correspond to the function of an existing key or they can be parameterized as special disabling functions.</p> <p>Visible only if "Behaviour during active disabling = all keys behave like" or "Behaviour during active disabling = individual keys behave like"!</p> <p>*: The number of keys depends on the projected pushbutton sensor variant!</p>

<p>Reaction of pushbutton sensor at the end of disabling</p> <p>Key >>Y<<</p>	<p>no reaction reaction like key >>Y<< when pressed reaction like key >>Y<< when released reaction like disabling function 1 when pressed reaction like disabling function 1 when released reaction like disabling function 2 when pressed reaction like disabling function 2 when released internal scene recall scene 1 internal scene recall scene 2 internal scene recall scene 3 internal scene recall scene 4 internal scene recall scene 5 internal scene recall scene 6 internal scene recall scene 7 internal scene recall scene 8</p> <p>key 1 key 2 ... key 16 *</p>	<p>Besides disabling of rocker and key functions, the pushbutton sensor can also trigger a special function immediately at the end of disabling.</p> <p>This function can...</p> <ul style="list-style-type: none"> • correspond to the function assigned to any of the keys in the non-disabled state ("Reaction like key >>Y<< ..."), • be defined on the following parameter pages ("Reaction like disabling function ..."), • recall a scene stored internally in the pushbutton sensor ("Internal scene recall ..."). <p>If the pushbutton sensor is to perform the function of a specific key at the end of the disabling state, this key will be selected here.</p> <p>Visible only if "Reaction of pushbutton sensor at the beginning of the disabling state = Reaction like key >>X<< on pressing / releasing of the key"!</p> <p>*: The number of keys depends on the projected pushbutton sensor variant!</p>
<p>Key selection disable</p> <p><input type="checkbox"/> Visible only if "Behaviour during active disabling = individual keys no function" or "Behaviour during active disabling = individual keys behave like"!</p>		
<p>Selection of the keys for behaviour during disabling</p> <p>Key 1?</p> <p>Key 2?</p> <p>...</p> <p>Key 16?*</p>	<p>yes no</p> <p>yes no</p> <p>yes no</p>	<p>The user can specify for each key separately whether it will be affected by the disabling function during the disabling state.</p> <p>*: The number of keys depends on the projected pushbutton sensor variant!</p>
<p>Disabling function 1 disable / Disabling function 2 disable</p> <p><input type="checkbox"/> With the exception of the status LED control, the parameters available for the two disabling functions are the same as those for the key functions.</p>		

<input type="checkbox"/> Scenes / scene data types (name of parameter page changes with scene function activated).		
Scene function?	yes no	The pushbutton sensor can handle internally eight scenes with eight actuator groups. This parameter activates the scene function and the other parameters and communication objects, if needed.
Overwrite scene values during ETS download	yes no	If the values of the actuator groups that have been changed on site by the customer are to be reset to the values preset in the ETS during an application download by the ETS, the setting "Yes" must be chosen. If "No" is selected, the ETS values will not overwrite the scene values stored in the pushbutton sensor, if any.
Data types scene output 1	switching value (0 ... 255) value / shutter position (0 ... 100 %)	The pushbutton sensor has an independent communication object for each of the eight actuator groups. With these parameters, the object type can be set separately for each output.
...		
Scene output 8	switching value (0 ... 255) value / shutter position (0 ... 100 %)	
<input type="checkbox"/> Scene 1		
Recall via extension object with scene number	1 ... 64	If the internal scenes are to be recalled via the extension object, a definite number is required for each of them. This parameter serves to specify the extension number of the first scene. If several internal scenes have the same scene number, only the first scene with this number can be called up.
Scene output 1 switching command	no telegram ON OFF	This parameter can be used to predefine the switching command of the first scene output. Visible only if "Data types scene output 1 = switching"!
Scene output 1 value (0 ... 255)	0 ... 255	This parameter can be used to predefine the value of the first scene output. Visible only if "Data types scene output 1 = value (0 ... 255)"!
Scene output 1 value / shutter position (0 ... 100 %)	0 ... 100	This parameter can be used to predefine the value of the first scene output. Visible only if "Data types scene output 1 = value / shutter position (1 ... 100 %)"!

<p>Scene output 1 Permit storing?</p> <p>Scene output 1 Permit transmission?</p> <p>Scene output 1 Transmit delay (1 ... 1200 * 100 ms) (0 = deactivated)</p> <p>Scene outputs 2 ... 8 see scene output 1!</p>	<p>yes no</p> <p>yes no</p> <p>0 ... 1200</p>	<p>If the user is to be given the possibility of changing the value of the actuator group (scene output) within this scene and of storing it during regular operation, this parameter must be set to "Yes".</p> <p>If the state of actuator group is to remain unchanged during the recall of a scene, this parameter can be set to "No". In this case, the pushbutton sensor does not transmit a telegram via the scene output concerned during the recall of the scene. The scene output is deactivated for this scene.</p> <p>When the pushbutton sensor sends the telegrams to the various scene outputs, it can insert a presettable waiting time of 2 min. max. before each telegram.</p> <p>This can be used to reduce bus loading, but also to have certain lamps switched on only after the shutters are really closed.</p> <p>If no delay is selected, the pushbutton sensor sends the output telegrams with maximum speed. With this setting it may happen in some cases that the telegram sequence is not compatible with output numbering.</p>
<p><input type="checkbox"/> Scenes 2 ... 8 see scene 1!</p>		
<p><input type="checkbox"/> Alarm signalling Alarm signal display</p>	<p>activated deactivated</p>	<p>This parameter can be used to enable alarm signal displaying When alarm signalling is enabled, the ETS displays further parameters and up to two further communication objects.</p>

<p>Polarity of the alarm signalling object</p>	<p>alarm when ON and alarm reset when OFF alarm when OFF and alarm reset when ON</p>	<p>The alarm signalling object is used as an input for activating or deactivating alarm signal displaying. When the object value corresponds to the "Alarm" condition, all status LEDs and the operation LED are always blinking with a frequency of ca. 2 Hz.</p> <p>If the setting is "Alarm when OFF and alarm reset when ON", the object must first be actively written by the bus with "0" to activate the alarm after a reset.</p> <p>An alarm message is not stored so that alarm signal displaying is generally deactivated after a reset or after programming with the ETS.</p>
<p>Reset alarm signalling by a key-press?</p>	<p>yes no</p>	<p>If this parameter is set to "Yes", active alarm signal displaying can be deactivated by a key-press on the pushbutton sensor. This key-press does not cause the parameterized function of the pressed key to be executed. Only after then next key-press will the parameterization of the key be evaluated and a telegram be transmitted to the bus, if applicable. If "No" has been selected, alarm signalling can only be deactivated via the alarm signalling object. A key-press will always execute the parameterized key function.</p>
<p>Use the alarm acknowledge object?</p>	<p>yes no</p>	<p>If alarm signalling can be deactivated by a key-press, this parameter defines whether an additional alarm acknowledge telegram is to be transmitted to the bus via the separate object "Alarm signalling acknowledge" after triggering by this key-press.</p> <p>A telegram can, for instance, be sent via this object to the "Alarm signalling" objects of other pushbutton sensors in order to reset the alarm status there as well (observe the polarity of the acknowledge object!).</p>
<p>Acknowledge alarm signalling by</p>	<p>OFF telegram ON telegram</p>	<p>This parameter sets the polarity of the "Alarm signalling acknowledge" object.</p> <p>*: This parameter presetting depends on the selected polarity of the alarm signalling object.</p>
<p>Software information ---</p>		

FD-design

Cover for FD push-button module

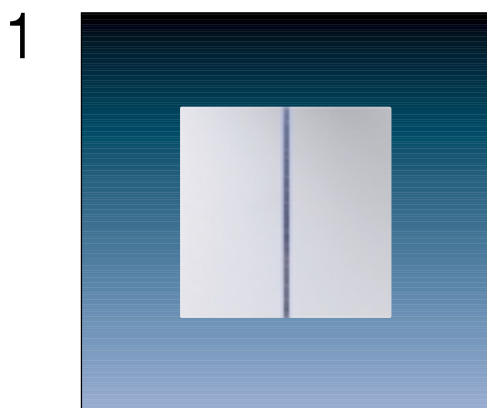

2

	Ref.-No.
Cover for FD push-button module to clip on push-button module 1-gang	
ivory	FD 901 TSA
white	FD 901 TSA WW
light grey	FD 901 TSA LG
Metal versions	
stainless steel	FDES 2901 TSA
aluminium	FDAL 2901 TSA
anthracite	FDAL 2901 TSA AN
Suitable modules:	3071 TSM, 3091 TSM

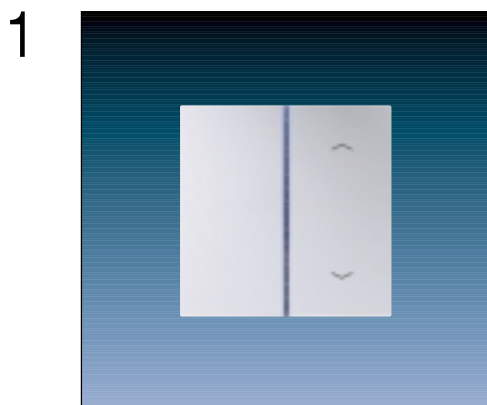

2

	Ref.-No.
Cover for FD push-button module with symbols to clip on push-button module 1-gang	
ivory	FD 901 TSAP
white	FD 901 TSAP WW
light grey	FD 901 TSAP LG
Metal versions	
stainless steel	FDES 2901 TSAP
aluminium	FDAL 2901 TSAP
anthracite	FDAL 2901 TSAP AN
Suitable modules:	3071 TSM, 3091 TSM

FD-design

Cover for FD push-button module



2

	Ref.-No.
Cover for FD push-button module with inscription plate 68.5 x 68.5 mm to clip on push-button module 1-gang	
ivory	FD 901 TSANA
white	FD 901 TSANA WW
light grey	FD 901 TSANA LG
Metal versions	
stainless steel	FDES 2901 TSANA
aluminium	FDAL 2901 TSANA
anthracite	FDAL 2901 TSANA AN
Suitable modules:	3071 TSM, 3091 TSM

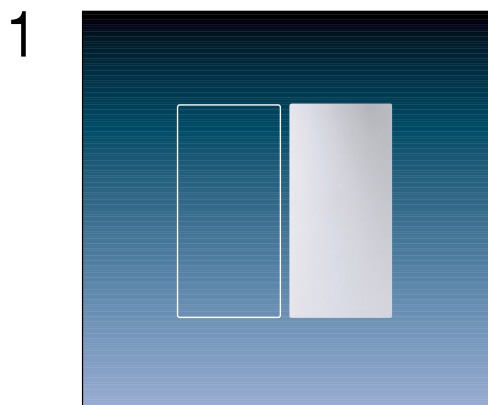

2

	Ref.-No.
Cover for FD push-button module to clip on push-button module 2-gang or 3-gang	
ivory	FD 902 TSA
white	FD 902 TSA WW
light grey	FD 902 TSA LG
Metal versions	
stainless steel	FDES 2902 TSA
aluminium	FDAL 2902 TSA
anthracite	FDAL 2902 TSA AN
Suitable modules:	3072 TSM, 3073 TSM, 3092 TSM, 3093 TSM, 3091 TSML

FD-design

Cover for FD push-button module

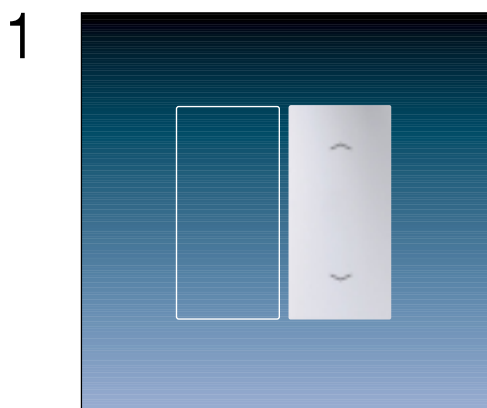

2

	Ref.-No.
Cover for FD push-button module with symbols to clip on push-button module 2-gang or 3-gang	
ivory	FD 902 TSAP
white	FD 902 TSAP WW
light grey	FD 902 TSAP LG
Metal versions	
stainless steel	FDES 2902 TSAP
aluminium	FDAL 2902 TSAP
anthracite	FDAL 2902 TSAP AN
Suitable modules:	3072 TSM, 3073 TSM, 3092 TSM, 3093 TSM, 3091 TSML

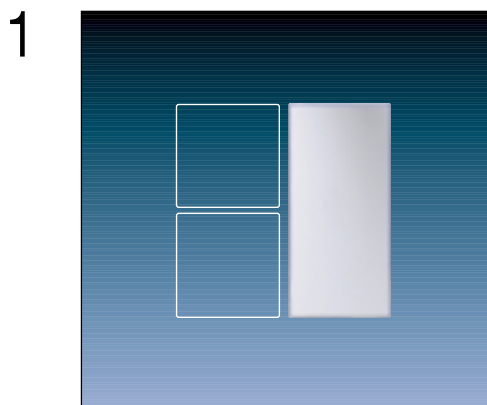

2

	Ref.-No.
Cover for FD push-button module with inscription plate 32 x 68.5 mm to clip on push-button module 2-gang or 3-gang	
ivory	FD 902 TSANA
white	FD 902 TSANA WW
light grey	FD 902 TSANA LG
Metal versions	
stainless steel	FDES 2902 TSANA
aluminium	FDAL 2902 TSANA
anthracite	FDAL 2902 TSANA AN
Suitable modules:	3072 TSM, 3073 TSM, 3092 TSM, 3093 TSM, 3091 TSML

FD-design

Cover for FD push-button module

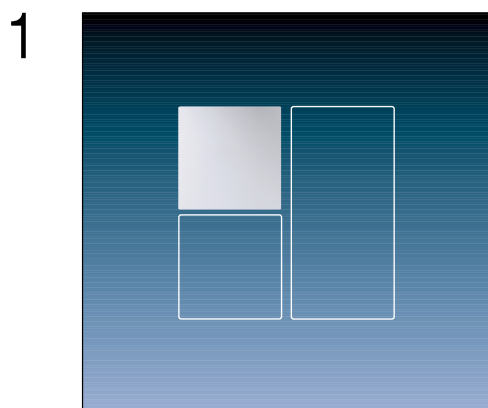

2

	Ref.-No.
Cover for FD push-button module	
to clip on push-button module 3-gang or 4-gang	
ivory	FD 904 TSA
white	FD 904 TSA WW
light grey	FD 904 TSA LG
Metal versions	
stainless steel	FDES 2904 TSA
aluminium	FDAL 2904 TSA
anthracite	FDAL 2904 TSA AN
Suitable modules:	3073 TSM, 3074 TSM, 3093 TSM, 3094 TSM, 3078 TSM, 3098 TSM, 3092 TSML

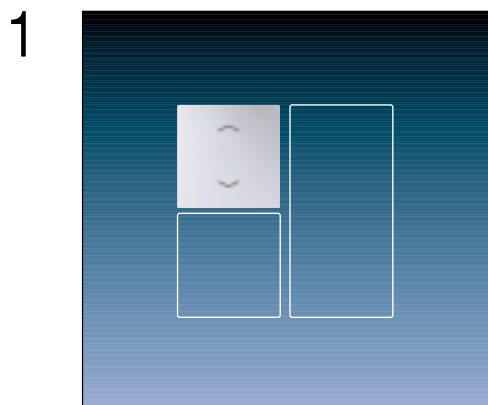

2

	Ref.-No.
Cover for FD push-button module with symbols	
to clip on push-button module 2-gang or 3-gang	
ivory	FD 904 TSAP
white	FD 904 TSAP WW
light grey	FD 904 TSAP LG
Metal versions	
stainless steel	FDES 2904 TSAP
aluminium	FDAL 2904 TSAP
anthracite	FDAL 2904 TSAP AN
Suitable modules:	3073 TSM, 3074 TSM, 3093 TSM, 3094 TSM, 3078 TSM, 3098 TSM, 3092 TSML

FD-design

Cover for FD push-button module

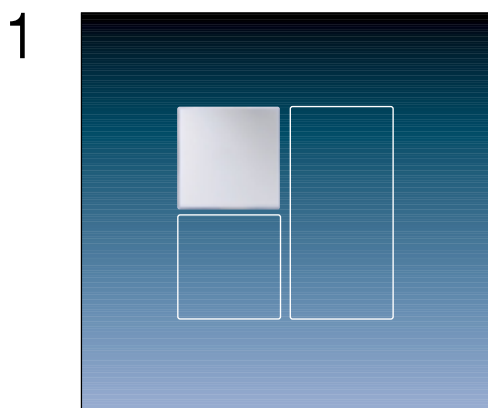

2

	Ref.-No.
Cover for FD push-button module with inscription plate 32 x 33 mm to clip on push-button module 3-gang or 4-gang	
ivory	FD 904 TSANA
white	FD 904 TSANA WW
light grey	FD 904 TSANA LG
Metal versions	
stainless steel	FDES 2904 TSANA
aluminium	FDAL 2904 TSANA
anthracite	FDAL 2904 TSANA AN
Suitable modules:	3073 TSM, 3074 TSM, 3093 TSM, 3094 TSM, 3078 TSM, 3098 TSM, 3092 TSML

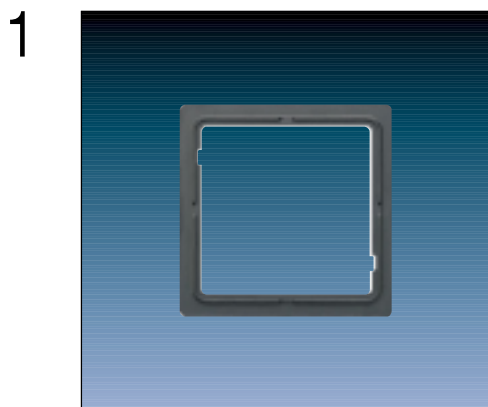

2

	Ref.-No.
Intermediate frame	FD 981 Z

3 For the installation of SCHUKO sockets, data/TV sockets and rotary dimmer of the design ranges LS 990, Stainless Steel, Aluminium and Anthracite into FD frames.

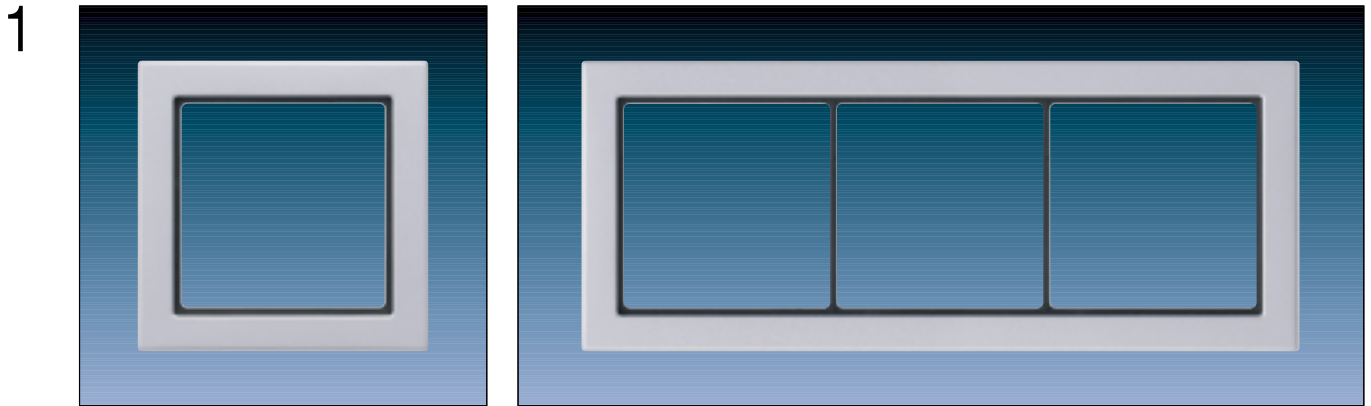

2

		Ref.-No.
Frames for vertical and horizontal installation		
ivory	1-gang 96 x 96 x 6.3 mm	FD 981 W
	2-gang 96 x 167 x 6.3 mm	FD 982 W
	3-gang 96 x 238 x 6.3 mm	FD 983 W
white	1-gang 96 x 96 x 6.3 mm	FD 981 WW
	2-gang 96 x 167 x 6.3 mm	FD 982 WW
	3-gang 96 x 238 x 6.3 mm	FD 983 WW
light grey	1-gang 96 x 96 x 6.3 mm	FD 981 LG
	2-gang 96 x 167 x 6.3 mm	FD 982 LG
	3-gang 96 x 238 x 6.3 mm	FD 983 LG
Metal versions		
aluminium	1-gang 96 x 96 x 6.3 mm	FDAL 2981
	2-gang 96 x 167 x 6.3 mm	FDAL 2982
	3-gang 96 x 238 x 6.3 mm	FDAL 2983
stainless steel	1-gang 96 x 96 x 6.3 mm	FDES 2981
	2-gang 96 x 167 x 6.3 mm	FDES 2982
	3-gang 96 x 238 x 6.3 mm	FDES 2983
anthracite	1-gang 96 x 96 x 6.3 mm	FDAL 2981 AN
	2-gang 96 x 167 x 6.3 mm	FDAL 2982 AN
	3-gang 96 x 238 x 6.3 mm	FDAL 2983 AN

Push-Buttons – Standard

CD 500 / CD plus

1

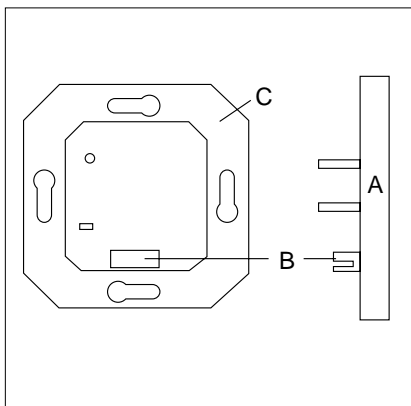
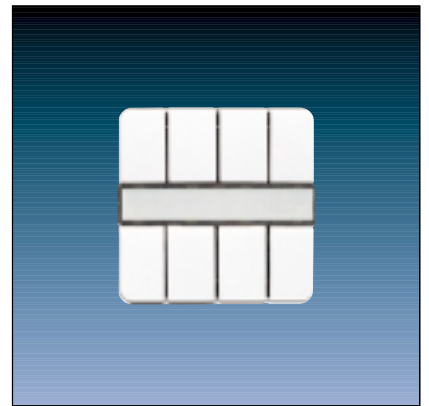
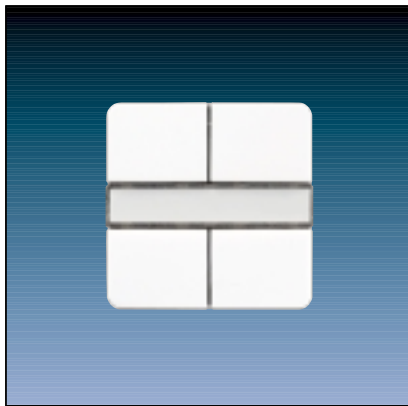

A: Application module (AM)
 B: Application interface (AI)
 C: Bus coupling unit (BCU)

2

	Ref.-No.
KNX push-button, 1-gang	
ETS-product family:	Push-button
Product type:	1-gang push-button
ivory	2071 NABS
white	CD 2071 NABS WW
blue	CD 2071 NABS BL
brown	CD 2071 NABS BR
grey	CD 2071 NABS GR
light grey	CD 2071 NABS LG
red	CD 2071 NABS RT
black	CD 2071 NABS SW
gold-bronze	CD 2071 NABS GB

3

The 1-gang push-button is plugged onto a flush mounted bus coupling unit. With an appropriate application program, it sends telegrams, for example, to actuators for switching on/off lights, for dimming lights, for recalling and saving light scenes, or for moving blinds/shutters up or down and for adjusting the louvres of blinds.
 Status and operation indication is possible with 2 LED's.

Software applications:		
Switching with status	100112	Vers. 1.2
Switching with transmission control	100912	Vers. 1.2
Dimming	100C12	Vers. 1.2
Shutter	100D12	Vers. 1.2
Value transmitting	101B01	Vers. 1
Switch/toggle	103001	Vers. 1

2		Ref.-No.
	KNX push-button, 2-gang	
	ETS-product family:	Push-button
	Product type:	2-gang push-button
	ivory	2072 NABS
	white	CD 2072 NABS WW
	blue	CD 2072 NABS BL
	brown	CD 2072 NABS BR
	grey	CD 2072 NABS GR
	light grey	CD 2072 NABS LG
	red	CD 2072 NABS RT
	black	CD 2072 NABS SW
	gold-bronze	CD 2072 NABS GB

- 3** The 2-gang push-button is plugged onto a flush mounted bus coupling unit. With an appropriate application program, it sends telegrams, for example, to actuators for switching on/off lights, for dimming lights, for recalling and saving light scenes, or for moving blinds/shutters up or down and for adjusting the louvres of blinds.
Status and operation indication is possible with 3 LED's.

Software applications:

Switching with status	100312	Vers. 1.2
Switching with transmission control	100A12	Vers. 1.2
Dimming	102A01	Vers. 1
Shutter	102B01	Vers. 1
Value transmitting	101C01	Vers. 1
Switch/toggle	103101	Vers. 1
Dimming / shutter	103A01	Vers. 1
Switch / shutter	103B01	Vers. 1
Switch / dimming	103C01	Vers. 1

2		Ref.-No.
	KNX push-button, 4-gang	
	ETS-product family:	Push-button
	Product type:	4-gang push-button
	ivory	2074 NABS
	white	CD 2074 NABS WW
	blue	CD 2074 NABS BL
	brown	CD 2074 NABS BR
	grey	CD 2074 NABS GR
	light grey	CD 2074 NABS LG
	red	CD 2074 NABS RT
	black	CD 2074 NABS SW
	gold-bronze	CD 2074 NABS GB

- 3** The 4-gang push-button is plugged onto a flush mounted bus coupling unit. With an appropriate application program, it sends telegrams, for example, to actuators for switching on/off lights, for dimming lights, for recalling and saving light scenes, or for moving blinds/shutters up or down and for adjusting the louvres of blinds.
Status and operation indication is possible with 5 LED's.

Software applications:

Switching with status	102E01	Vers. 1
Switching with transmission control	102F01	Vers. 1
Dimming	102D01	Vers. 1
Shutter	102C01	Vers. 1
Value transmitting	101D01	Vers. 1

4 Technical data

Supply

Voltage:	24 V DC (+6 V / -4 V) via BCU
Power consumption:	max. 150 mW
Connection:	2 x 5-pole pin bar
Protection:	IP 20
Insulation voltage:	referring to VDE 0829 part 230

Behaviour at

Bus voltage drop:	Object values will be set to "0". LED's are going off, no telegram is sent.
Bus voltage return:	Object values remain to "0". LED's remain off, no telegram is sent.

Operation temperature: -5°C ... +45°C

Storage temperature: -25°C ... +75°C

Mounting: plugged onto a flush mounted BCU

Note: Mechanical theft protection of the application module is provided.

Push-Buttons – Standard

LS 990 / LS plus / Stainless Steel
Aluminium / Anthracite / Gold / Chrome

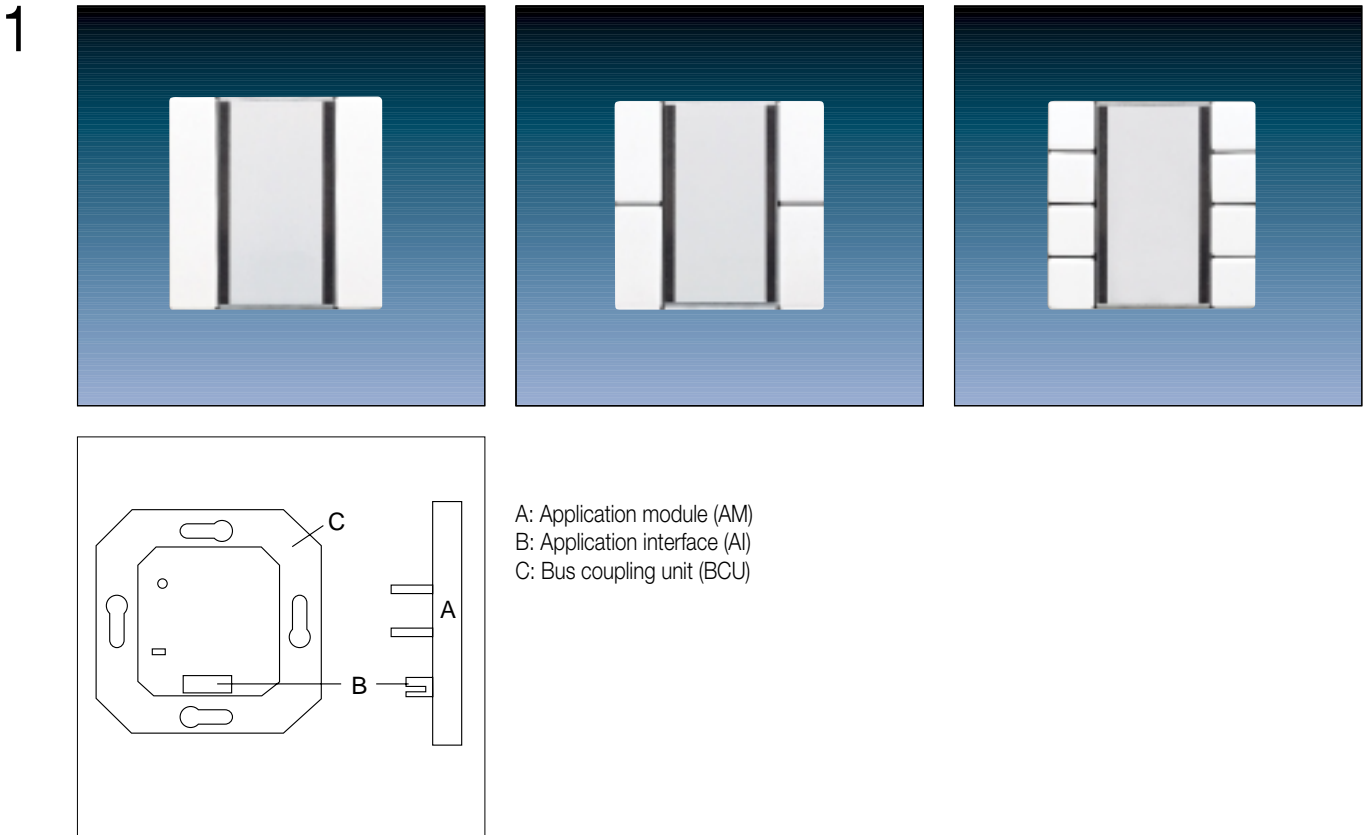

2

	Ref.-No.
KNX push-button, 1-gang	
ETS-product family:	Push-button
Product type:	1-gang push-button
ivory	LS 2071 NABS
white	LS 2071 NABS WW
light grey	LS 2071 NABS LG
Metal versions	
stainless steel	ES 2071 NABS
aluminium	AL 2071 NABS
anthracite	AL 2071 NABS AN
gold coloured	GO 2071 NABS
chrome	GCR 2071 NABS

3 The 1-gang push-button is plugged onto a flush mounted bus coupling unit. With an appropriate application program, it sends telegrams, for example, to actuators for switching on/off lights, for dimming lights, for recalling and saving light scenes, or for moving blinds/shutters up or down and for adjusting the louvres of blinds.
Status and operation indication is possible with 2 LED's.

Software applications:

Switching with status	100112	Vers. 1.2
Switching with transmission control	100912	Vers. 1.2
Dimming	100C12	Vers. 1.2
Shutter	100D12	Vers. 1.2
Value transmitting	101B01	Vers. 1
Switch/toggle	103001	Vers. 1

2		Ref.-No.
	KNX push-button, 2-gang	
	ETS-product family:	Push-button
	Product type:	2-gang push-button
	ivory	LS 2072 NABS
	white	LS 2072 NABS WW
	light grey	LS 2072 NABS LG
	Metal versions	
	stainless steel	ES 2072 NABS
	aluminium	AL 2072 NABS
	anthracite	AL 2072 NABS AN
	gold coloured	GO 2072 NABS
	chrome	GCR 2072 NABS

3 The 2-gang push-button is plugged onto a flush mounted bus coupling unit. With an appropriate application program, it sends telegrams, for example, to actuators for switching on/off lights, for dimming lights, for recalling and saving light scenes, or for moving blinds/shutters up or down and for adjusting the louvres of blinds.
Status and operation indication is possible with 3 LED's.

Software applications:

Switching with status	100312 Vers. 1.2	Switch / toggle	103101 Vers. 1
Switching with transmission control	100A12 Vers. 1.2	Dimming / shutter	103A01 Vers. 1
Dimming	102A01 Vers. 1	Switch / shutter	103B01 Vers. 1
Shutter	102B01 Vers. 1	Switch / dimming	103C01 Vers. 1
Value transmitting	101C01 Vers. 1		

2		Ref.-No.
	KNX push-button, 4-gang	
	ETS-product family:	Push-button
	Product type:	4-gang push-button
	ivory	LS 2074 NABS
	white	LS 2074 NABS WW
	light grey	LS 2074 NABS LG
	Metal versions	
	stainless steel	ES 2074 NABS
	aluminium	AL 2074 NABS
	anthracite	AL 2074 NABS AN
	gold coloured	GO 2074 NABS
	chrome	GCR 2074 NABS

3 The 4-gang push-button is plugged onto a flush mounted bus coupling unit. With an appropriate application program, it sends telegrams, for example, to actuators for switching on/off lights, for dimming lights, for recalling and saving light scenes, or for moving blinds/shutters up or down and for adjusting the louvres of blinds.
Status and operation indication is possible with 5 LED's.

Software applications:

Switching with status	102E01 Vers. 1
Switching with transmission control	102F01 Vers. 1
Dimming	102D01 Vers. 1
Shutter	102C01 Vers. 1
Value transmitting	101D01 Vers. 1

4 Technical data

Supply

Voltage:	24 V DC (+6 V / -4 V) via BCU
Power consumption:	max. 150 mW
Connection:	2 x 5-pole pin bar
Protection:	IP 20
Insulation voltage:	referring to VDE 0829 part 230

Behaviour at

Bus voltage drop:	Object values will be set to "0". LED's are going off, no telegram is sent.
Bus voltage return:	Object values remain to "0". LED's remain off, no telegram is sent.

Operation temperature:

-5°C ... +45°C

Storage temperature:

-25°C ... +75°C

Mounting:

plugged onto a flush mounted BCU

Note:

Mechanical theft protection of the application module is provided.

Push-Buttons – Standard

AS 500 / A 500 / A plus

1

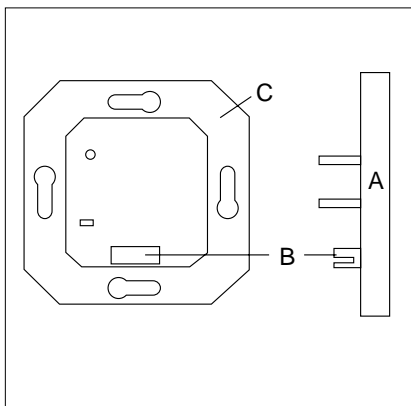
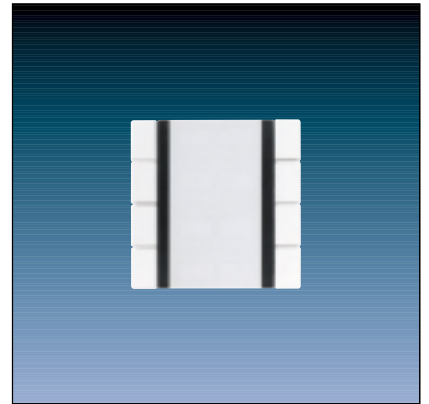
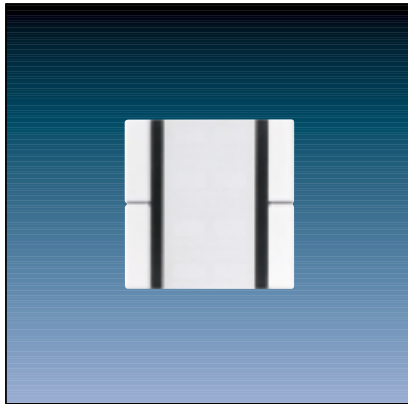
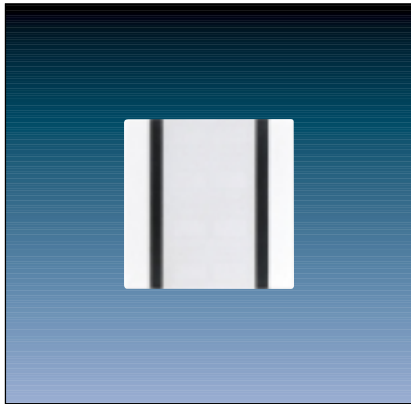

A: Application module (AM)
 B: Application interface (AI)
 C: Bus coupling unit (BCU)

2

	Ref.-No.
KNX push-button, 1-gang	
ETS-product family:	Push-button
Product type:	1-gang push-button
ivory	A 2071 NABS
white	A 2071 NABS WW
aluminium	A 2071 NABS AL

3

The 1-gang push-button is plugged onto a flush mounted bus coupling unit. With an appropriate application program, it sends telegrams, for example, to actuators for switching on/off lights, for dimming lights, for recalling and saving light scenes, or for moving blinds/shutters up or down and for adjusting the louvres of blinds. Status and operation indication is possible with 2 LED's.

Software applications:

Switching with status	100112	Vers. 1.2
Switching with transmission control	100912	Vers. 1.2
Dimming	100C12	Vers. 1.2
Shutter	100D12	Vers. 1.2
Value transmitting	101B01	Vers. 1
Switch/toggle	103101	Vers. 1

2		Ref.-No.
	KNX push-button, 2-gang	
	ETS-product family:	Push-button
	Product type:	2-gang push-button
	ivory	A 2072 NABS
	white	A 2072 NABS WW
	aluminium	A 2072 NABS AL

3 The 2-gang push-button is plugged onto a flush mounted bus coupling unit. With an appropriate application program, it sends telegrams, for example, to actuators for switching on/off lights, for dimming lights, for recalling and saving light scenes, or for moving blinds/shutters up or down and for adjusting the louvres of blinds.
Status and operation indication is possible with 3 LED's.

Software applications:

Switching with status	100312 Vers. 1.2	Switch / toggle	103101 Vers. 1
Switching with transmission control	100A12 Vers. 1.2	Dimming / shutter	103A01 Vers. 1
Dimming	102A01 Vers. 1	Switch / shutter	103B01 Vers. 1
Shutter	102B01 Vers. 1	Switch / dimming	103C01 Vers. 1
Value transmitting	101C01 Vers. 1		

2		Ref.-No.
	KNX push-button, 4-gang	
	ETS-product family:	Push-button
	Product type:	4-gang push-button
	ivory	A 2074 NABS
	white	A 2074 NABS WW
	aluminium	A 2074 NABS AL

3 The 4-gang push-button is plugged onto a flush mounted bus coupling unit. With an appropriate application program, it sends telegrams, for example, to actuators for switching on/off lights, for dimming lights, for recalling and saving light scenes, or for moving blinds/shutters up or down and for adjusting the louvres of blinds.
Status and operation indication is possible with 5 LED's.

Software applications:

Switching with status	102E01 Vers. 1
Switching with transmission control	102F01 Vers. 1
Dimming	102D01 Vers. 1
Shutter	102C01 Vers. 1
Value transmitting	101D01 Vers. 1

4 Technical data

Supply	
Voltage:	24 V DC (+6 V / -4 V) via BCU
Power consumption:	max. 150 mW
Connection:	2 x 5-pole pin bar
Protection:	IP 20
Insulation voltage:	referring to VDE 0829 part 230
Behaviour at	
Bus voltage drop:	Object values will be set to "0". LED's are going off, no telegram is sent.
Bus voltage return:	Object values remain to "0". LED's remain off, no telegram is sent.
Operation temperature:	-5°C ... +45°C
Storage temperature:	-25°C ... +75°C
Mounting:	plugged onto a flush mounted BCU
Note:	Mechanical theft protection of the application module is provided.

Push-Buttons – Universal

CD 500 / CD plus

1

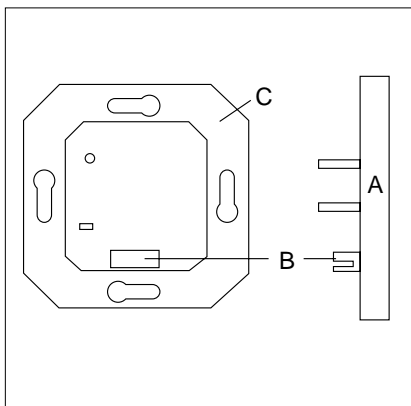
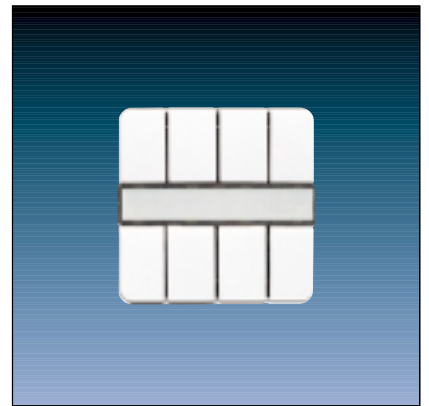
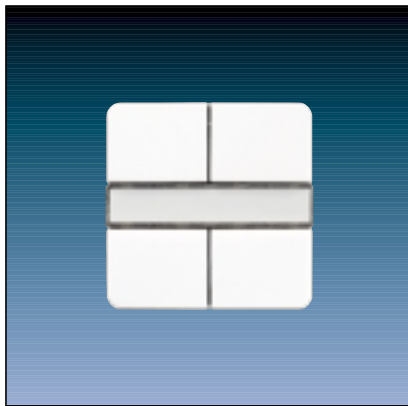

A: Application module (AM)
 B: Application interface (AI)
 C: Bus coupling unit (BCU)

2

	Ref.-No.
KNX push-button, 1-gang	
ETS-product family:	Push-button
Product type:	1-gang push-button
ivory	2091 NABS
white	CD 2091 NABS WW
blue	CD 2091 NABS BL
brown	CD 2091 NABS BR
grey	CD 2091 NABS GR
light grey	CD 2091 NABS LG
red	CD 2091 NABS RT
black	CD 2091 NABS SW
gold-bronze	CD 2091 NABS GB
KNX push-button, 2-gang	
ETS-product family:	Push-button
Product type:	2-gang push-button
ivory	2092 NABS
white	CD 2092 NABS WW
blue	CD 2092 NABS BL
brown	CD 2092 NABS BR
grey	CD 2092 NABS GR
light grey	CD 2092 NABS LG
red	CD 2092 NABS RT
black	CD 2092 NABS SW
gold-bronze	CD 2092 NABS GB

2	Ref.-No.
KNX push-button, 4-gang	
ETS-product family:	Push-button
Product type:	4-gang push-button
ivory	2094 NABS
white	CD 2094 NABS WW
blue	CD 2094 NABS BL
brown	CD 2094 NABS BR
grey	CD 2094 NABS GR
light grey	CD 2094 NABS LG
red	CD 2094 NABS RT
black	CD 2094 NABS SW
gold-bronze	CD 2099 NABS GB

- 3 The KNX universal push-button is plugged onto a flush mounted bus coupling unit. Its 2 to 8 rockers can be adjusted with different functions in various combinations (switching, dimming, blind sensor or light scene/brightness value sensor). With the appropriate parameters, it sends telegrams, for example, to actuators for switching on/off lights, for dimming lights, for recalling and saving light scenes, or for moving blinds/shutters up or down and for adjusting the louvres of blinds and even to send temperature or brightness values (2 Bytes) to the bus. Status and operation indication is possible with 3 up to 9 LED's, that means each rocker has its own status LED.

4 Technical data

Supply	
Voltage:	24 V DC (+6 V / -4 V) via BCU
Power consumption:	max. 150 mW
Connection:	2 x 5-pole pin bar
Protection:	IP 20
Insulation voltage:	referring to VDE 0829 part 230
Behaviour at	
Bus voltage drop:	Object values will be set to "0". LED's are going off, no telegram is sent.
Bus voltage return:	Object values remain to "0". LED's remain off, no telegram is sent.
Operation temperature:	-5°C ... +45°C
Storage temperature:	-25°C ... +75°C
Mounting:	plugged onto a flush mounted BCU
Note:	Mechanical theft protection of the application module is provided.

- 5 Function switching:
 - Command at pressing/releasing of the push-button adjustable (ON, OFF, Toggle, no function).

Function dimming:

- Push-button function darker (OFF), brighter (ON) or darker/brighter (Toggle) adjustable.
- Time between dimming and switching and the dimming steps adjustable.
- Telegram repetition and stop telegram possible.

Function shutter/blinds:

- Push-button function (Up, Down) and time between short and long-time operation adjustable.
- Louvres adjustment possible.

Function value transmitter:

- The push-button function, dimming value-, brightness value- or temperature value-transmitter as well as recalling and saving light scenes, can be parameterized.
- Value adjustment via long push operation (dimming-, brightness-, temperature-value).

5

Notes to software application:

Switching function

- For a two level operation (toggle function), the objects of the relevant push-buttons must have the same group addresses.

Dimming function:

- For a correct function of the single level operation, the connected dimming actuator must send its status back to the switching object of the push-button, too.
- With the single level operation only the switching object is retriggered internally and externally. The dimming object (dimming direction) is retriggered only internally so that in case of used extensions (2 or more sensors dim one lamp) the dimming direction will not always be changed at a new push action.
- For a two level operation, the objects of the relevant push-buttons must have the same group addresses.

Shutter/blinds function:

- This function supports the two level operation only. Therefore the „Step“ and „Move“ objects of the relevant push-buttons must have the same group addresses.

Value transmitter function:

- At value adjustment via long push operation, the new adjusted values are stored only within the RAM. After bus voltage drop or a bus reset, these values will be exchanged with the values programmed with the ETS.
The value adjustment always is carried out in negative direction. After reaching the minimal value, it will continue automatically with the maximal value.

Push-Buttons – Universal

LS 990 / LS plus

Stainless Steel / Aluminium / Anthracite / Gold / Chrome

1

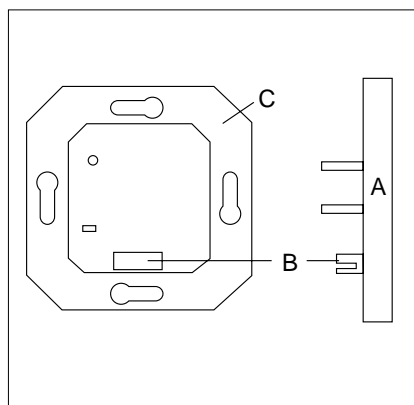
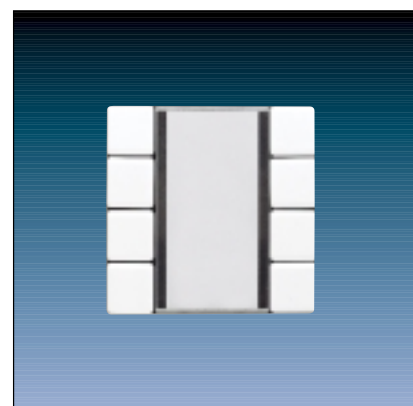

A: Application module (AM)
B: Application interface (AI)
C: Bus coupling unit (BCU)

2

	Ref.-No.
KNX push-button, 1-gang	
ETS-product family:	Push-button
Product type:	1-gang universal push-button
ivory	LS 2091 NABS
white	LS 2091 NABS WW
light grey	LS 2091 NABS LG
Metal versions	
stainless steel	ES 2091 NABS
aluminium	AL 2091 NABS
anthracite	AL 2091 NABS AN
gold coloured	GO 2091 NABS
chrome	GCR 2091 NABS
KNX push-button, 2-gang	
ETS-product family:	Push-button
Product type:	2-gang universal push-button
ivory	LS 2092 NABS
white	LS 2092 NABS WW
light grey	LS 2092 NABS LG
Metal versions	
stainless steel	ES 2092 NABS
aluminium	AL 2092 NABS
anthracite	AL 2092 NABS AN
gold coloured	GO 2092 NABS
chrome	GCR 2092 NABS

2	Ref.-No.
KNX push-button, 4-gang	
ETS-product family:	Push-button
Product type:	4-gang universal push-button
ivory	LS 2094 NABS
white	LS 2094 NABS WW
light grey	LS 2094 NABS LG
Metal versions	
stainless steel	ES 2094 NABS
aluminium	AL 2094 NABS
anthracite	AL 2094 NABS AN
gold	GO 2094 NABS
chrome	GCR 2094 NABS

3 The KNX universal push-button is plugged onto a flush mounted bus coupling unit. Its 2 to 8 rockers can be adjusted with different functions in various combinations (switching, dimming, blind sensor or light scene/brightness value sensor).
 With the appropriate parameters, it sends telegrams, for example, to actuators for switching on/off lights, for dimming lights, for recalling and saving light scenes, or for moving blinds/shutters up or down and for adjusting the louvres of blinds and even to send temperature or brightness values (2 Bytes) to the bus.
 Status and operation indication is possible with 3 up to 9 LED's, that means each rocker has its own status LED.

4 Technical data

Supply

Voltage: 24 V DC (+6 V / -4 V) via BCU

Power consumption: max. 150 mW

Connection: 2 x 5-pole pin bar

Protection: IP 20

Insulation voltage: referring to VDE 0829 part 230

Behaviour at

Bus voltage drop: Object values will be set to "0".
LED's are going off, no telegram is sent.

Bus voltage return: Object values remain to "0".
LED's remain off, no telegram is sent.

Operation temperature: -5°C ... +45°C

Storage temperature: -25°C ... +75°C

Mounting: plugged onto a flush mounted BCU

Note: Mechanical theft protection of the application module is provided.

5

Function switching:

- Command at pressing/releasing of the push-button adjustable (ON, OFF, Toggle, no function).

Function dimming:

- Push-button function darker (OFF), brighter (ON) or darker/brighter (Toggle) adjustable.
- Time between dimming and switching and the dimming steps adjustable.
- Telegram repetition and stop telegram possible.

Function shutter/blinds:

- Push-button function (Up, Down) and time between short and long-time operation adjustable.
- Louvres adjustment possible.

Function value transmitter:

- The push-button function, dimming value-, brightness value- or temperature value-transmitter as well as recalling and saving light scenes, can be parameterized.
- Value adjustment via long push operation (dimming-, brightness-, temperature-value).

Notes to software application:

Switching function

- For a two level operation (toggle function), the objects of the relevant push-buttons must have the same group addresses.

Dimming function:

- For a correct function of the single level operation, the connected dimming actuator must send its status back to the switching object of the push-button, too.
- With the single level operation only the switching object is retriggered internally and externally. The dimming object (dimming direction) is retriggered only internally so that in case of used extensions (2 or more sensors dim one lamp) the dimming direction will not always be changed at a new push action.
- For a two level operation, the objects of the relevant push-buttons must have the same group addresses.

Shutter/blinds function:

- This function supports the two level operation only. Therefore the „Step“ and „Move“ objects of the relevant push-buttons must have the same group addresses.

Value transmitter function:

- At value adjustment via long push operation, the new adjusted values are stored only within the RAM. After bus voltage drop or a bus reset, these values will be exchanged with the values programmed with the ETS.
The value adjustment always is carried out in negative direction. After reaching the minimal value, it will continue automatically with the maximal value.

Push-Buttons – Universal

AS 500 / A 500 / A plus

1

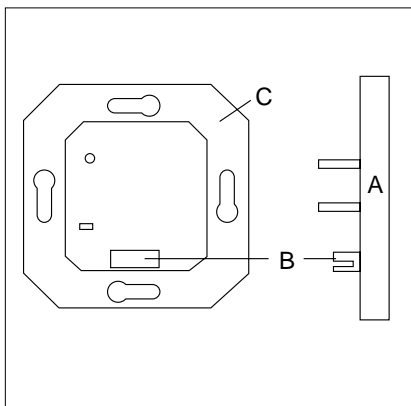
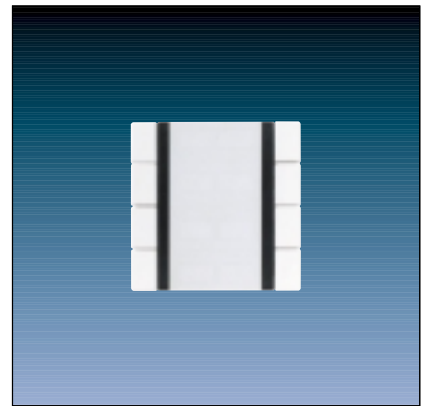
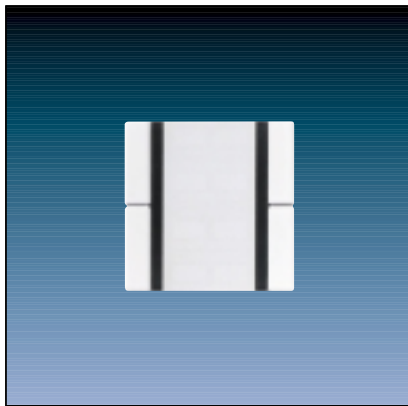
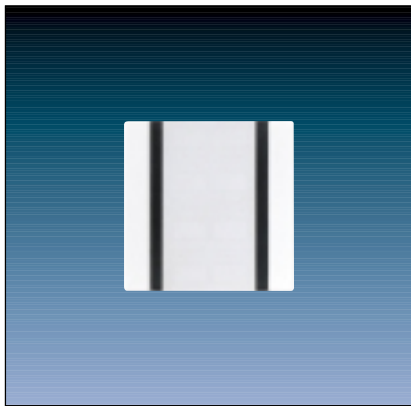

A: Application module (AM)
 B: Application interface (AI)
 C: Bus coupling unit (BCU)

2

	Ref.-No.
KNX push-button, 1-gang	
ETS-product family:	Push-button
Product type:	1-gang universal push-button
ivory	A 2091 NABS
white	A 2091 NABS WW
aluminium	A 2091 NABS AL
KNX push-button, 2-gang	
ETS-product family:	Push-button
Product type:	2-gang universal push-button
ivory	A 2092 NABS
white	A 2092 NABS WW
aluminium	A 2092 NABS AL
KNX push-button, 4-gang	
ETS-product family:	Push-button
Product type:	4-gang universal push-button
ivory	A 2094 NABS
white	A 2094 NABS WW
aluminium	A 2094 NABS AL

3

The KNX universal push-button is plugged onto a flush mounted bus coupling unit. Its 2 to 8 rockers can be adjusted with different functions in various combinations (switching, dimming, blind sensor or light scene/brightness value sensor).
 With the appropriate parameters, it sends telegrams, for example, to actuators for switching on/off lights, for dimming lights, for recalling and saving light scenes, or for moving blinds/shutters up or down and for adjusting the louvres of blinds and even to send temperature or brightness values (2 Bytes) to the bus.
 Status and operation indication is possible with 3 up to 9 LED's, that means each rocker has its own status LED.

4 Technical data

Supply	
Voltage:	24 V DC (+6 V / -4 V) via BCU
Power consumption:	max. 150 mW
Connection:	2 x 5-pole pin bar
Protection:	IP 20
Insulation voltage:	referring to VDE 0829 part 230
Behaviour at	
Bus voltage drop:	Object values will be set to "0". LED's are going off, no telegram is sent.
Bus voltage return:	Object values remain to "0". LED's remain off, no telegram is sent.
Operation temperature:	-5°C ... +45°C
Storage temperature:	-25°C ... +75°C
Mounting:	plugged onto a flush mounted BCU
Note:	Mechanical theft protection of the application module is provided.

5 Function switching:

- Command at pressing/releasing of the push-button adjustable (ON, OFF, Toggle, no function).

Function dimming:

- Push-button function darker (OFF), brighter (ON) or darker/brighter (Toggle) adjustable.
- Time between dimming and switching and the dimming steps adjustable.
- Telegram repetition and stop telegram possible.

Function shutter/blinds:

- Push-button function (Up, Down) and time between short and long-time operation adjustable.
- Louvres adjustment possible.

Function value transmitter:

- The push-button function, dimming value-, brightness value- or temperature value-transmitter as well as recalling and saving light scenes, can be parameterized.
- Value adjustment via long push operation (dimming-, brightness-, temperature-value).

Notes to software application:

Switching function

- For a two level operation (toggle function), the objects of the relevant push-buttons must have the same group addresses.

Dimming function:

- For a correct function of the single level operation, the connected dimming actuator must send its status back to the switching object of the push-button, too.
- With the single level operation only the switching object is retriggered internally and externally. The dimming object (dimming direction) is retriggered only internally so that in case of used extensions (2 or more sensors dim one lamp) the dimming direction will not always be changed at a new push action.
- For a two level operation, the objects of the relevant push-buttons must have the same group addresses.

Shutter/blinds function:

- This function supports the two level operation only. Therefore the „Step“ and „Move“ objects of the relevant push-button must have the same group addresses.

Value transmitter function:

- At value adjustment via long push operation, the new adjusted values are stored only within the RAM. After bus voltage drop or a bus reset, these values will be exchanged with the values programmed with the ETS.
The value adjustment always is carried out in negative direction. After reaching the minimal value, it will continue automatically with the maximal value.

Push-Buttons – Light Scene Control

1

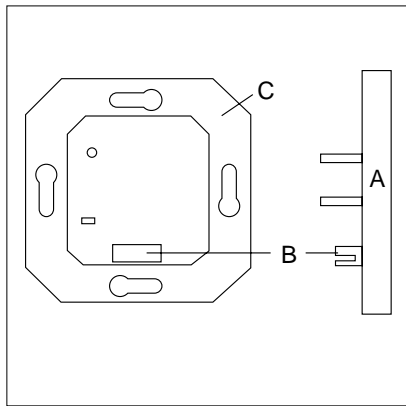
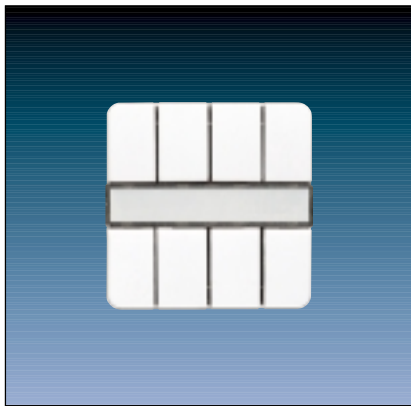

A: Application module (AM)
B: Application interface (AI)
C: Bus coupling unit (BCU)

2

	Ref.-No.
KNX light scene push-button, ranges CD 500/CD plus	
ETS-product family:	Push-button
Product type:	General push-button
ivory	2094 LZ
white	CD 2094 LZ WW
blue	CD 2094 LZ BL
brown	CD 2094 LZ BR
grey	CD 2094 LZ GR
light grey	CD 2094 LZ LG
red	CD 2094 LZ RT
black	CD 2094 LZ SW

1

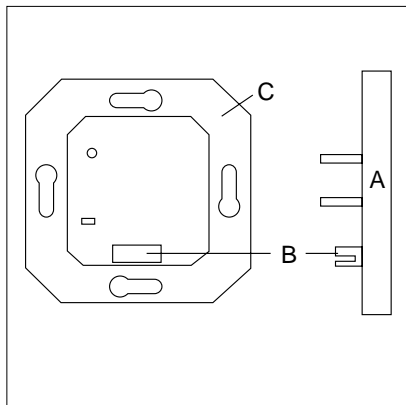
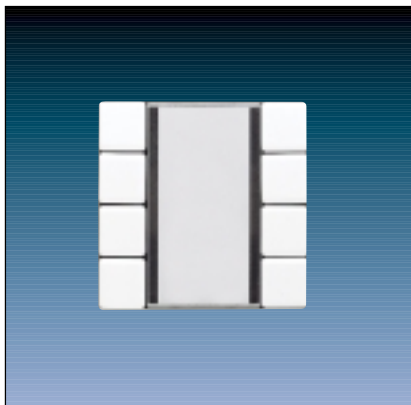

A: Application module (AM)
B: Application interface (AI)
C: Bus coupling unit (BCU)

2

	Ref.-No.
KNX light scene push-button, ranges LS 990/LS plus, Stainless Steel, Aluminium, Anthracite, Gold, Chrome	
ETS-product family:	Push-button
Product type:	General push-button
ivory	LS 2094 LZ
white	LS 2094 LZ WW
light grey	LS 2094 LZ LG
Metal versions	
stainless steel	ES 2094 LZ
aluminium	AL 2094 LZ
anthracite	AL 2094 LZ AN
gold coloured	GO 2094 LZ
chrome	GCR 2094 LZ

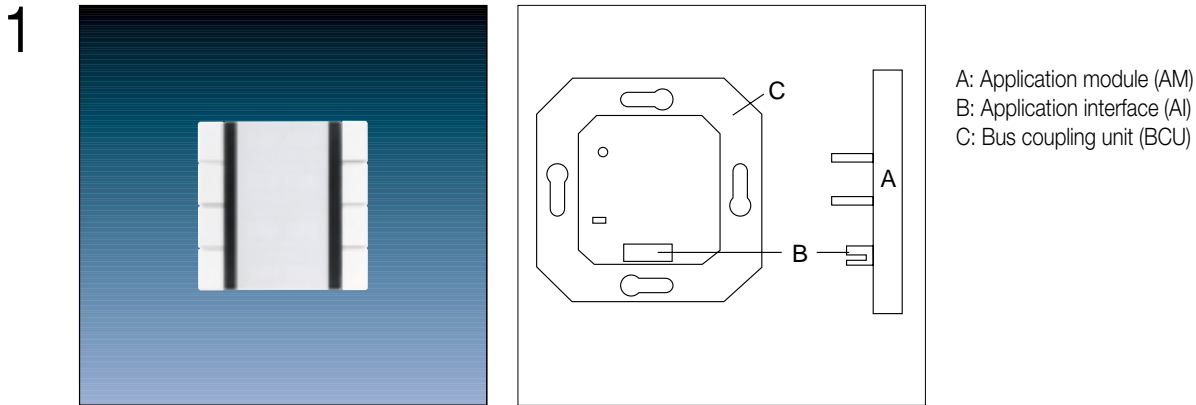

2

	Ref.-No.
KNX light scene push-button, ranges A 500/A plus	
ETS-product family:	Push-button
Product type:	General push-button
ivory	A 2094 LZ
white	A 2094 LZ WW
aluminium	A 2094 LZ AL

3

The KNX light scene push-button stores up to 8 different light scenes from incandescent, low/high voltage halogen and fluorescent lamps. It is also possible to integrate blinds/shutters into the light scene control. The individual light scenes are stored by pressing any of the 8 rockers for about 5 seconds. A LED signals the correct storage procedure.

The brightness values for the different light scenes are recalled by pressing briefly. Operation from extension units (satellites) is possible as well. The light scene push-button has three different operation modes. Besides saving and recalling light scenes, it is also possible to switch/dim up to 8 different lighting groups. Hence, there is no necessity of two additional 4-gang push-button to adjust the brightness values or the switching conditions ON/OFF.

Another mode facilitates a cascade of light scene push-buttons to have more than 8 different lighting groups integrated into the light scene control. Furthermore, special light effects can be realized in the cascade mode with endless operation.

4

Technical data	
Supply	
Voltage:	24 V DC (+6 V / -4 V) via BCU
Power consumption:	max. 150 mW
Connection:	2 x 5-pole pin bar
Protection:	IP 20
Insulation voltage:	referring to VDE 0829 part 230
Behaviour at voltage drop:	all object values are deleted
Operation temperature:	-5°C ... +45°C
Storage temperature:	-25°C ... +75°C
Mounting:	plugged onto a flush mounted BCU
Note:	Mechanical theft protection of the application module is provided.

5 Description of application Light scene mode

The push button can save and recall up to eight different light scenes. Each light scene consists of up to eight different object values. These are either brightness values (dimming actuator, 0...255) or switch values (switch/shutter actuator, 0 or 1). By a short push (<1 sec.) on the rocker, a light scene will be recalled. During the recalling action of one light scene all brightness values or switching values of the dimming or switching actuators are transmitted. By a long push (>5 sec.) on the rocker, an adjusted light scene will be saved. As an acknowledge the corresponding status LED switches on after about 5 sec. During the saving action all brightness values or switching values of the dimming or switching actuators are read out. To read out these values there has to be set a R-flag in the switch object of one switching actuator per group and a R-flag in the brightness value object of one dimming actuator per group. By the light scene extension input object, the light scenes can be recalled and saved from any satellite (other sensors, binary inputs, etc).

Description of application Switch- / Dimming-Mode

By a special "Three-Rocker-Grip" you can switch-over to the switch-/dimming mode. That mode is indicated by the flashing operation LED (green). With that mode the push button can be used as a switching or dimming sensor for eight lighting groups. The device automatically switches-over into the light scene mode as long as there is no manual toggling selected. The switch-over time can be parameterized. If the manual toggling is selected, the Three-Rocker-Grip has to be repeated.

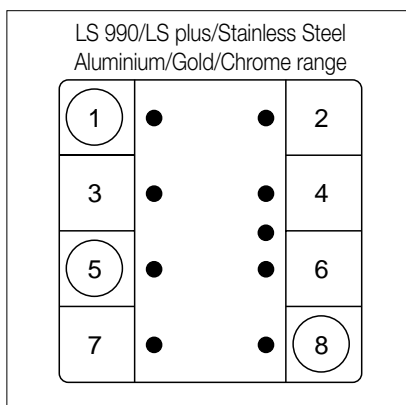
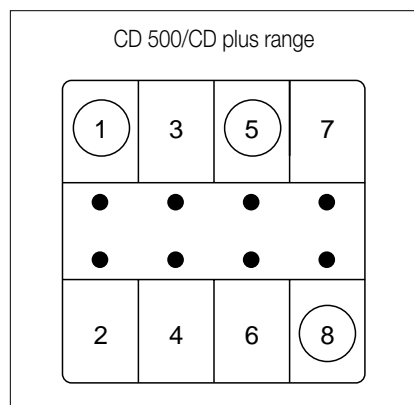

Three-Rocker-Grip:
push rocker 1, 5, 8 simultaneously

Objects

Number of addresses (dynamic): 22
 Number of assignments (dynamic): 22
 Communication objects: 20

Object	Name	Function	Type	Flag
0	Output 1	Value 1 switch/dimming	1 / 8 Bit	C, W, T
1	Output 2	Value 2 switch/dimming	1 / 8 Bit	C, W, T
2	Output 3	Value 3 switch/dimming	1 / 8 Bit	C, W, T
3	Output 4	Value 4 switch/dimming	1 / 8 Bit	C, W, T
4	Output 5	Value 5 switch/dimming	1 / 8 Bit	C, W, T
5	Output 6	Value 6 switch/dimming	1 / 8 Bit	C, W, T
6	Output 7	Value 7 switch/dimming	1 / 8 Bit	C, W, T
7	Output 8	Value 8 switch/dimming	1 / 8 Bit	C, W, T
8	Output 1	Dimming	4 Bit	C, T
9	Output 2	Dimming	4 Bit	C, T
10	Output 3	Dimming	4 Bit	C, T
11	Output 4	Dimming	4 Bit	C, T
12	Output 5	Dimming	4 Bit	C, T
13	Output 6	Dimming	4 Bit	C, T
14	Output 7	Dimming	4 Bit	C, T
15	Output 8	Dimming	4 Bit	C, T
16	Input	Light scene cascade	1 Byte	C, W, T
17	Input	Light scene extension	1 Byte	C, W, T
18	Output	Light scene cascade	1 Byte	C, T
19	Disable	Operation	1 Bit	C, W, T

Push-Buttons – Radio Control

1

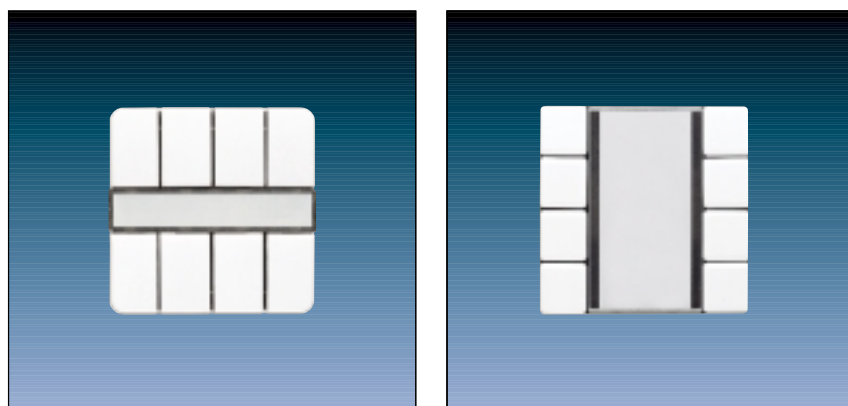

2

	Ref.-No.
KNX 4-gang universal push-button	
Radio-controlled	
ETS-product family:	Push-button
Product type:	General push-button
ranges CD 500/CD plus	
ivory	2094 F
white	CD 2094 F WW
blue	CD 2094 F BL
brown	CD 2094 F BR
grey	CD 2094 F GR
light-grey	CD 2094 F LG
black	CD 2094 F SW
ranges LS 990/LS plus, Stainless Steel, Aluminium, Gold, Chrome	
ivory	LS 2094 F
white	LS 2094 F WW
light-grey	LS 2094 F LG
Metal versions	
stainless steel	ES 2094 F
aluminium (laquered)	AL 2094 F
anthracite	AL 2094 F AN
gold coloured	GO 2094 F
chrome	GCR 2094 F

3

The radio controlled 4-gang universal push-button is plugged onto a flush mounted bus coupling unit. Its 8 rockers can be adjusted to four different functions separately (switching, dimming, blind/shutter control or value transmitter).

Depending on the adjusted function, it sends telegrams, e.g. to actuators for switching ON/OFF lights, for dimming lights, for recalling or saving light scenes, for moving shutters/blinds up or down and for adjusting the louvres and even to send brightness or temperature values (2 Bytes) to the bus.

Due to the integrated radio receiver, no status LED's are available.

Additionally to the manual operation, the push button can integrate radio controlled transmitters to the KNX.

The received radio signals will be transmitted to appropriate KNX-telegrams. The data transfer is unidirectional.

The following radio transmitters can be thought-in to the radio controlled push button:

Hand-held transmitters : 48 KFH, 48 FH, 42 FH.

Wall-mounted transmitters: 1-gang, 2-gang, 4-gang (the 4-gang transmitter can only control up to 4 channels of the 2094 F)

Flat wall-mounted transmitters: 1-gang, 2-gang, 4-gang (the 4-gang transmitter can only control up to 4 channels of the 2094 F)

Universal transmitter: FUS 22 UP

Multifunction transmitter: FMS 4 UP

Observer: FW 180 WW

Presence detector: FPM 360 WW

4 Technical data

Supply	
Voltage:	24 V DC (+6 V / -4 V) via BCU
Power consumption:	max. 150 mW
Connection:	2 x 5-pole pin bar
Input	
Number:	max 8 radio-controlled transmitters with max 12 channel
Transmission:	radio frequency
Carrier frequency:	433.42 MHz
Modulation:	ASK (Amplitude Shift Keying)
Transmission range:	max. 30 m (free field)
Protection:	IP 20
Behavior at bus voltage drop:	no reaction
recovery:	delete all object values
Operation temperature:	-5°C ... +45°C
Storage temperature:	-25°C ... +70°C

5 Guide line for programming:

When working with the radio controlled push button the ETS design work should be finished before radio transmitters are thought-in. The following diagram shows the process:

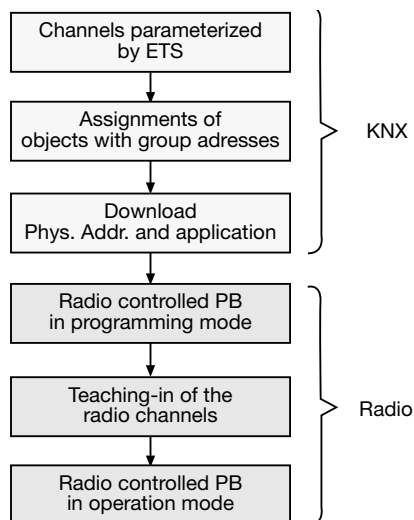

Programming mode of radio controlled push button:

By a special "Three-Rocker-Grip" you can switch over from the operation mode into the programming mode to teach-in the radio transmitters. Push-buttons 1, 5 and 8 have to be pressed until the green LED is flashing. Then the radio channels can be selected and the red LED is flashing until a transmitter channel is thought-in.

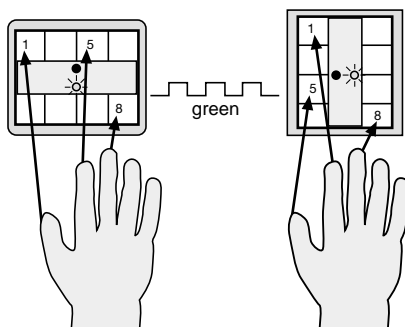

5

Description of software application:

- Free assignment of the functions switching, dimming, shutter/blind and value transmitter to the 8 push-buttons.
- The received radio signals will be transmitted to appropriate KNX-telegrams. The data transfer is unidirectional.
- For each push-button, up to 12 transmitters with 8 different functions can be taught-in.
- Operation display by the green LED.

Function switching:

- Command at pressing/releasing of the push-button adjustable (ON, OFF, Toggle, no function).

Function dimming:

- Push button function darker (OFF), brighter (ON) or darker/brighter (Toggle) adjustable.
- Time between dimming and switching and the dimming steps adjustable.
- Telegram repetition and stop telegram possible.

Function shutter/blinds:

- Push button function (Up/Down) and time between short and long-time operation adjustable.
- Louvres adjustment possible.

Function value transmitter:

- The push button function, dimming value-, brightness value- or temperature value-transmitter as well as recalling and saving light scenes, can be parameterized.
Value adjustment via long push operation (dimming-, brightness-, temperature-value).

Objects:

Number of addresses:	27
Number of assignments:	27
Communication objects:	17

Object	Name	Function	Type	Flag
0	Output 1	Switch	1 Bit	W, C, T
1	Output 2	Switch	1 Bit	W, C, T
2	Output 3	Switch	1 Bit	W, C, T
3	Output 4	Switch	1 Bit	W, C, T
4	Output 1	Logic link	1 Bit	W, C, T
5	Output 2	Logic link	1 Bit	W, C, T
6	Output 3	Logic link	1 Bit	W, C, T
7	Output 4	Logic link	1 Bit	W, C, T
Function: Switching (for all push buttons *)				
0 – 7	PB1-PB8	Switching	1 Bit	C, W, T, (R)
Function: Dimming (for all push buttons *)				
0 – 7	PB1-PB8	Switching	1 Bit	C, W, T, (R)
8 – 5	PB1-PB8	Dimming	4 Bit	C, T
Function: shutter/blinds (for all push buttons *)				
0 – 7	PB1-PB8	Short time operation	1 Bit	C, T, (R)
8 – 15	PB1-PB8	Long time operation	1 Bit	C, T
Function: value transmitter (light scene control, for all push buttons *)				
8 – 15	PB1-PB8	Light scene extension	1 Byte	C, T
Function: value transmitter (temperature value transmitter, for all push buttons *)				
8 – 15	PB1-PB8	Temp. value transmitter	2 Byte	C, T
Function: value transmitter (brightness value transmitter, for all push buttons *)				
8 – 15	PB1-PB8	Brightness value transmitter	2 Byte	C, T
Function: value transmitter (dimming value transmitter, for all push buttons *)				
8 – 15	PB1-PB8	Dimming value transmitter	1 Byte	C, T
Alarm function, data format 1Bit				
16	PB sensor	Alarm	1 Bit	C, W, (R)
Alarm function, data format 1Byte				
16	PB sensor	Alarm	1 Byte	C, W, (R)

Objects marked with (R): Object value can be read out (set R-flag!)

Functions marked with *: The functions (switching, dimming, shutter/blinds, value transmitter) can be chosen for each PB separately.
Due to this choice the communication objects and the object table will change.

5

Notes to software application:

Switching function

- For a two level operation, the objects of the relevant push-buttons must have the same group addresses.

Dimming function:

- For a correct function of the single level operation, the connected dimming actuator must send its status back to switching object of the push-button, too.
- With the single level operation only the switching object is retriggered internally and externally. The dimming object (dimming direction) is retriggered only internally so that in case of used extensions (2 or more sensors dim one lamp) the dimming direction will not always be changed at a new push action.
- For a two level operation, the objects of the relevant push-buttons must have the same group addresses.

Shutter/blinds function:

- This function supports the two level operation only. Therefore the „Step“ and „Move“ objects of the relevant push-button must have the same group addresses.

Value transmitter function:

- At value adjustment via long push operation, the new adjusted values are stored only within the RAM. After bus voltage drop or a bus reset, these values will be exchanged with the values programmed with the ETS.
The value adjustment always is carried out in negative direction. After reaching the minimal value, it will continue automatically with the maximal value.

Push-Button BCU 1-gang (switch/neutral position)

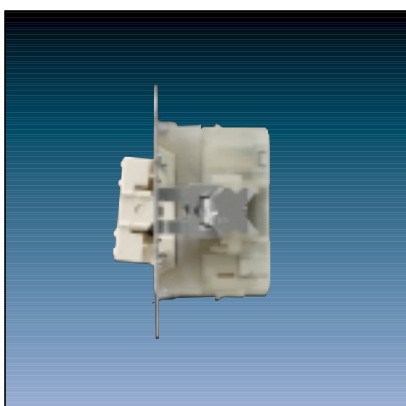

2

	Ref.-No.
KNX push-button BCU, 1-gang	2071.01 LED
ETS-product family:	Push-button
Product type:	Push-button, 1-gang

3 The 1-gang push-button BCU is an interface between an integrated conventional push-button and the KNX. The conventional rocker plate has a switch position and can operate one switching group. With the application program, it sends telegrams, for example, to actuators for switching on/off lights, for dimming lights and saving light scenes. Status indication is possible with one LED.

Software applications:

Switching	105501
Switching, dimming, value transmitting	107401

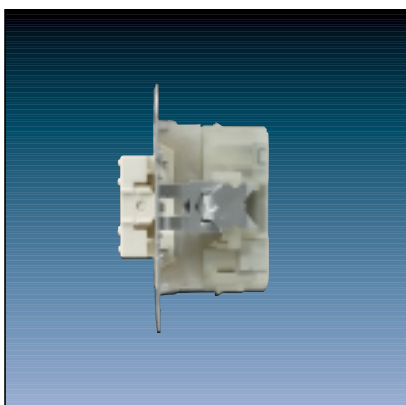

2

	Ref.-No.
KNX push-button BCU, 1-gang	2071.02 LED
ETS-product family:	Push-button
Product type:	Push-button, 1-gang

3 The 1-gang push-button BCU is an interface between an integrated conventional push-button and the KNX. The conventional rocker plate has a neutral position and can operate up to two different groups (with switch function). With the appropriate parameters it sends telegrams, for example, to actuators for switching on/off lights, for dimming lights, for recalling and saving light scenes or for moving blinds/shutters up or down and for adjusting the louvres of blinds. Status indication is possible with one LED and a specific LED object.

Software applications:

Switch, dimming, shutter	105601
Switch, dimming, shutter, value transmitting	107301

Push-Button BCU 2-gang

(switch/neutral position)

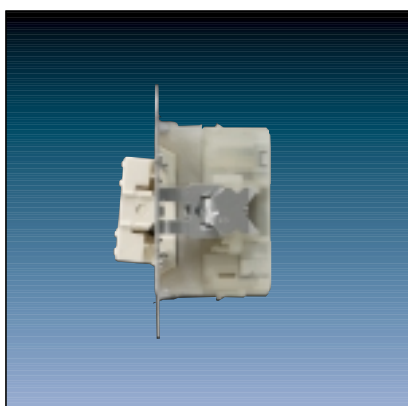
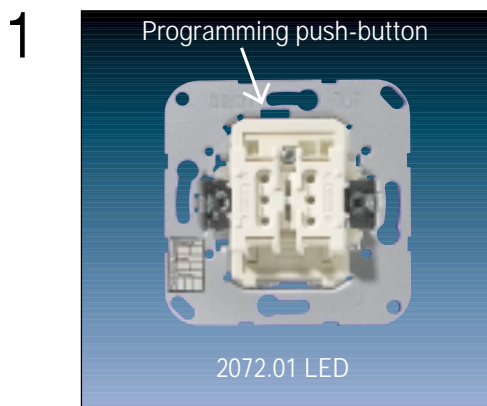

2		Ref.-No.
	KNX push-button BCU 2-gang	2072.01 LED
	ETS-product family:	Push-button
	Product type:	Push-button, 2-gang

3 The 2-gang push-button BCU is an interface between an integrated conventional push-button and the KNX. The conventional rocker plate has a switch position and can operate up to two different groups (with switch function).
With the appropriate parameters it sends telegrams, for example, to actuators for switching on/off lights, for dimming lights, for recalling and saving light scenes or for moving blinds/shutters up or down and for adjusting the louvres of blinds. Status indication is possible with two LED's.

Software applications:	
Switch, dimming, shutter	105701
Switch, dimming, shutter, value transmitting	106701

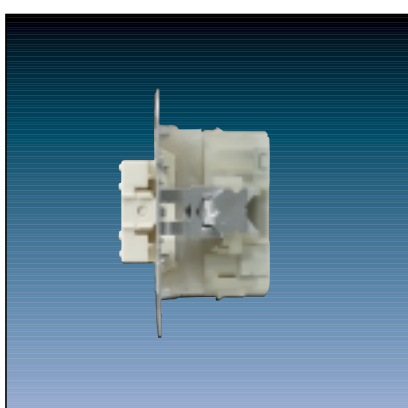
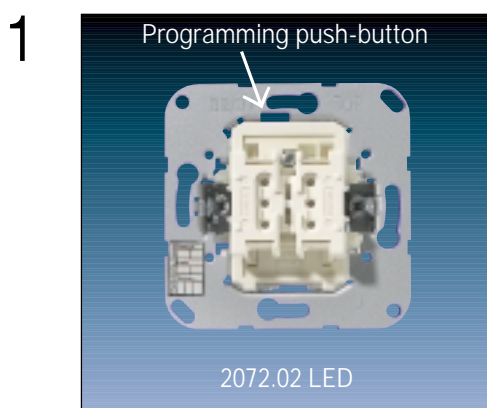

2		Ref.-No.
	KNX push-button BCU 2-gang	2072.02 LED
	ETS-product family:	Push-button
	Product type:	Push-button, 2-gang

3 The 2-gang push-button BCU is an interface between an integrated conventional push-button and the KNX. The conventional rocker plate has a neutral position and can operate up to four different groups (with switch function).
With the appropriate parameters it sends telegrams, for example, to actuators for switching on/off lights, for dimming lights, for recalling and saving light scenes or for moving blinds/shutter up or down and for adjusting the louvres of blinds. Status indication is possible with two LED's.

Software applications:	
Switch, dimming, shutter	105801
Switch, dimming, shutter, value transmitting	106001

4 Technical data

Supply	
Voltage:	24 V DC (+6 V / -4 V)
Power consumption:	max. 150 mW
Connection:	KNX connection block
Protection:	IP 20
Behaviour at	
Bus voltage drop:	Object values will be set to "0". LED's are switched off, no telegram is sent.
Bus voltage returns:	Object values remain "0". LED's remain off, no telegram is sent.
Operation temperature:	-5°C ... +45°C
Storage temperature:	-40°C ... +55°C

The push-button BCU fits in every JUNG range like
 CD 500/CD plus, LS 990/LS plus, Stainless Steel, Aluminium, AS 500/A 500/A plus and SL 500.
 The corresponding Ref.-No. are shown in the main catalogue.



Programs

- AS 500
- A 500
- CD 500
- SL 500
- LS 990
- Stainless Steel
- Aluminium
- Anthracite
- Gold
- Chrom



Push-Button BCU 1-gang

WG 800 IP 44 breakproof

1



2

	Ref.-No.
KNX push-button BCU, 1-gang	
switch position	8071.01 LED W
ETS-product family:	Push-button
Product type:	Push-button, 1-gang

3

Function Switching, dimming, value transmitting
Status indication with one LED.
Depending on the version of the push-button BCU – 1-gang rocker or 2-gang rocker – center plates are used with and without indication lights. The “upper” or “lower” rockers can be controlled with the push-button with “neutral position”, while only the “lower” rocker can be pressed with the push-button with “switch position”. The push-button BCU can only function with an application program i.e. the push-button BCU consists of the device (hardware) and the application program (software).

1



2

	Ref.-No.
KNX push-button BCU, 1-gang	
neutral position	8071.02 LED W
ETS-product family:	Push-button
Product type:	Push-button, 1-gang

3

Function Switching, dimming, value transmitting
Status indication with one LED and specific LED object.
Depending on the version of the push-button BCU – 1-gang rocker or 2-gang rocker – center plates are used with and without indication lights. The “upper” or “lower” rockers can be controlled with the push-button with “neutral position”, while only the “lower” rocker can be pressed with the push-button with “switch position”. The push-button BCU can only function with an application program i.e. the push-button BCU consists of the device (hardware) and the application program (software).

Push-Button BCU 2-gang

WG 800 IP 44 breakproof

1



2

	Ref.-No.
KNX push-button BCU, 2-gang	
switch position	8072.01 LED W
ETS-product family:	Push-button
Product type:	Push-button, 1-gang

3

Function Switching, dimming, value transmitting

Status indication with two LEDs.

Depending on the version of the push-button BCU – 1-gang rocker or 2-gang rocker – center plates are used with and without indication lights.

The “upper” or “lower” rockers can be controlled with the push-button with “neutral position”, while only the “lower” rocker can be pressed with the push-button with “switch position”. The push-button BCU can only function with an application program i.e. the push-button BCU consists of the device (hardware) and the application program (software).

1



2

	Ref.-No.
KNX push-button BCU, 2-gang	
neutral position	8072.02 LED W
ETS-product family:	Push-button
Product type:	Push-button, 1-gang

3

Function Switching, dimming, value transmitting

Status indication with one LED and specific LED object.

Depending on the version of the push-button BCU – 1-gang rocker or 2-gang rocker – center plates are used with and without indication lights.

The “upper” or “lower” rockers can be controlled with the push-button with “neutral position”, while only the “lower” rocker can be pressed with the push-button with “switch position”. The push-button BCU can only function with an application program i.e. the push-button BCU consists of the device (hardware) and the application program (software).

Push-Button BCU 1-gang

WG 800 IP 44 breakproof

1

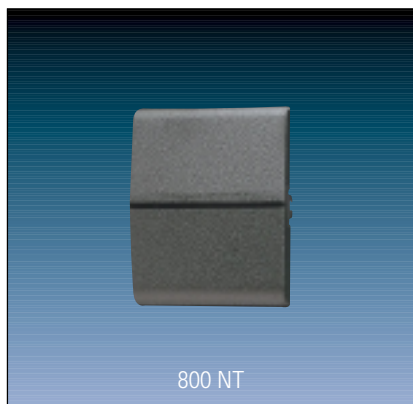

800 NT



800 P



800 NA

2

	Ref.-No.
Center plates for push-button BCU	
1-gang rocker	800 NT
Suitable inserts:	8071.01 LEDW, 8071.02 LED W
1-gang rocker with 2 symbols for up/down	800 P
Suitable inserts:	8071.02 LED W
1-gang rocker with inscription field	800 NA
Suitable inserts:	8071.01 LEDW, 8071.02 LED W

1

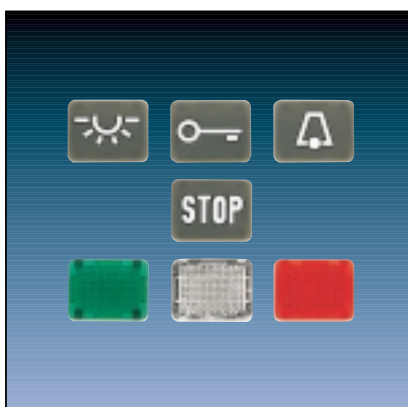
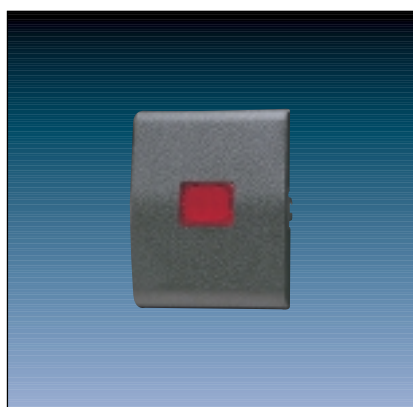

2

	Ref.-No.
Center plates for push-button BCU	
1-gang rocker with transparent lens	800 KO
Suitable inserts:	8071.01 LEDW, 8071.02 LED W
Symbols	
anthracite, light	33 AN L
anthracite, bell	33 AN K
anthracite, door	33 AN T
anthracite, neutral	33 AN N
anthracite, STOP	33 AN STOP
green, neutral	33 GN
transparent	33 KLAR
red, neutral	33 N R

Push-Button BCU 2-gang

WG 800 IP 44 breakproof

1

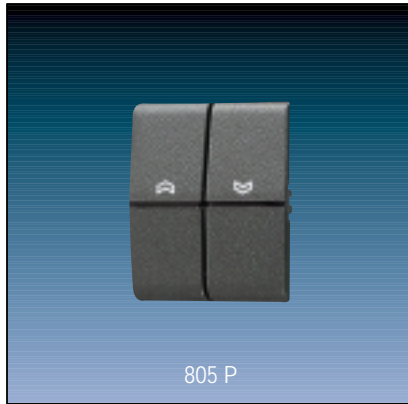
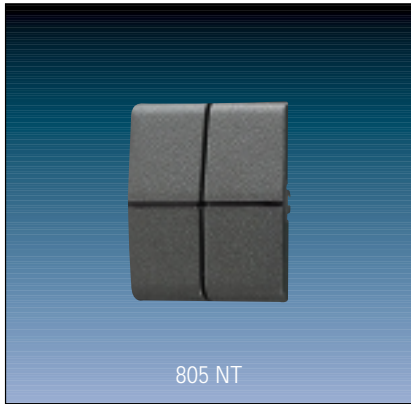

2

	Ref.-No.
Center plates for push-button BCU	
2-gang rocker	805 NT
Suitable inserts:	8072.01 LEDW, 8072.02 LED W
2-gang rocker with 2 symbols for up/down	805 P
Suitable inserts:	8072.01 LED W
2-gang rocker with 4 symbols for up/down	805 MP
Suitable inserts:	8072.02 LEDW

Room controller

LS 990 / LS plus

Stainless Steel / Aluminium

1



2

		Ref.-No.
KNX room controller display		
ETS-product family:	Heating, ventilation, A/C	
Product type:	Regulator	
3-gang	ivory	RCD 2021
	white	RCD 2021 WW
	light grey	RCD 2021 LG
	stainless steel	RCDES 2021
	aluminium (laquered)	RCDAL 2021
	anthracite (laquered)	RCDAL 2021 AN
	gold coloured	RCDGO 2021
4-gang	ivory	RCD 2022
	white	RCD 2022 WW
	light grey	RCD 2022 LG
	stainless steel	RCDES 2022
	aluminium (laquered)	RCDAL 2022
	anthracite (laquered)	RCDAL 2022 AN
	gold coloured	RCDGO 2022
5-gang	ivory	RCD 2023
	white	RCD 2023 WW
	light grey	RCD 2023 LG
	stainless steel	RCDES 2023
	aluminium (laquered)	RCDAL 2023
	anthracite (laquered)	RCDAL 2023 AN
	gold coloured	RCDGO 2023
6-gang	ivory	RCD 2024
	white	RCD 2024 WW
	light grey	RCD 2024 LG
	stainless steel	RCDES 2024
	aluminium (laquered)	RCDAL 2024
	anthracite (laquered)	RCDAL 2024 AN
	gold coloured	RCDGO 2024
8-gang	ivory	RCD 2044
	white	RCD 2044 WW
	light grey	RCD 2044 LG
	stainless steel	RCDES 2044
	aluminium (laquered)	RCDAL 2044
	anthracite (laquered)	RCDAL 2044 AN
	gold coloured	RCDGO 2044

- 3** The KNX room controller with display combines three devices:
- Universal push-button plus additional features
 - Room thermostat with continuous control or 2 point switch control method for heating and/or cooling and additional heating/cooling system, plus additional features
 - LCD display (visible: 30 mm / 35 mm), with restricted functions
 - Fan Coil Control

Via corresponding symbols the different operation modes are indicated. The device has a green operation LED and each push-button has its own red status LED with the option of an own communication object.

The device comes with a separate software which contains the application software as well as the data base. That software has to be installed first within the directory of the used ETS version. Then the data base has to be imported as usual within the ETS. By opening the parameters the embedded software is started automatically.

The room controller can be extended with additional push-buttons or socket outlets by using 3- to 5-gang frames.

The BCU is already integrated into the device.

Note: The device comes together with the software.

The latest software can be downloaded from our web-page: www.jung.de

4 Technical data

Supply

Voltage:	24 V DC (+6 V / -4 V) via integrated BCU
Power consumption:	max. 240 mW
Connection:	KNX connection block
Range of measurement:	0 ... 40°C
Comfort temperature:	7 ... 40°C
Set point offset:	max. ± 10 K
Protection:	IP 20
Operation temperature:	-5°C ... +45°C
Storage temperature:	-25°C ... +75°C

5 Connection and mounting of RCD 20xx:

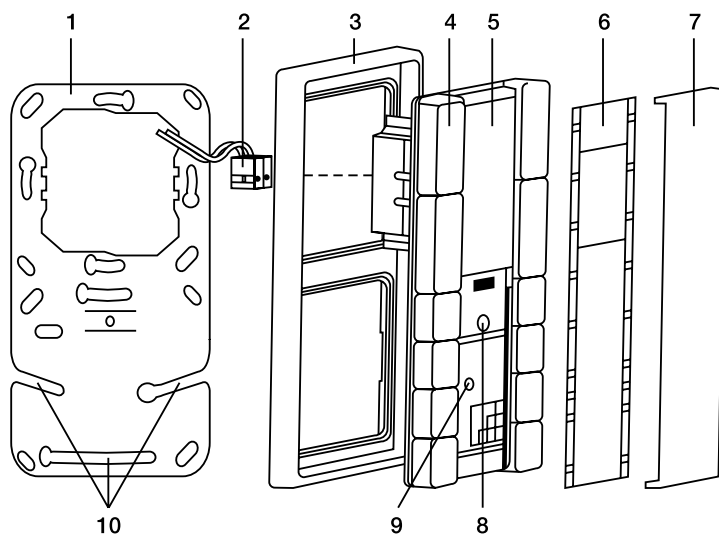

Mounting:

- a. Metal supporting frame (1) to be mounted on one or two vertically arranged wall boxes.
When using only one box, the lower part has to be screwed via the fixing holes (10).
- b. Attach the frame (3) to the RCD.
- c. Connect the bus terminal (2) at the back side.
- d. Attach the RCD (4) and frame (3) on the metal supporting frame (1).
- e. Screw on the fixing screw (8).
- f. Remove the protection foil (5) from the display.
- g. Put on the transparent cover (7) with the inscription foil (6) to the RCD.

The programming mode is activated by pushing the programming button (9).

Note: Do not mount the device next to heat sources due to the influence of the integrated temperature sensor.

5 Description of software application:

There are two operation levels to operate the room controller:

1. complete universal push-button functionality on all push-buttons
2. temperature adjustment with the four push-button beside the LCD display

By pressing the upper two push-buttons simultaneously for approx. 3 sec. the second level is activated. After the adjustments in this level, the change over into the first level is dependent on the parameter.

1. Operation level:
- Switching, toggling
 - Dimming (single level / two level dimming)
 - Shutter / blind control (single level / two level control)
 - Value transmitter
 - Light scene recall with memory
 - Light scene recall without memory
 - Brightness value transmitter (0 ... 1500 Lux)
 - Presence push-button for thermostat (comfort / stand by mode)
 - Set temperature offset adjustment (+ / -)
 - Enable / disable function for single push-buttons or for the whole RCD
 - Status LED for each push-button with separate objects
 - Display indication:
 - week day, time
 - set or real temperature
 - actual operation mode of the thermostat
 - external value (e.g. wind speed, outside temperature, etc.)
 - Fan coil control:
 - manual in 3 or 4 steps
 - automatic

Default setting:

In operation level 1 all push-buttons have the parameterised function. The LCD can display either the actual temperature, the actual set-temperature of the continuous regulator, the actual time, the actual date or an external value. When more than one information has to be displayed, the display is alternating.

In the default setting, the push-button on the left and right side of the display serve the presence and the set-temperature adjustment.

According to the needs, the default setting can be changed to the full function of an universal push-button.

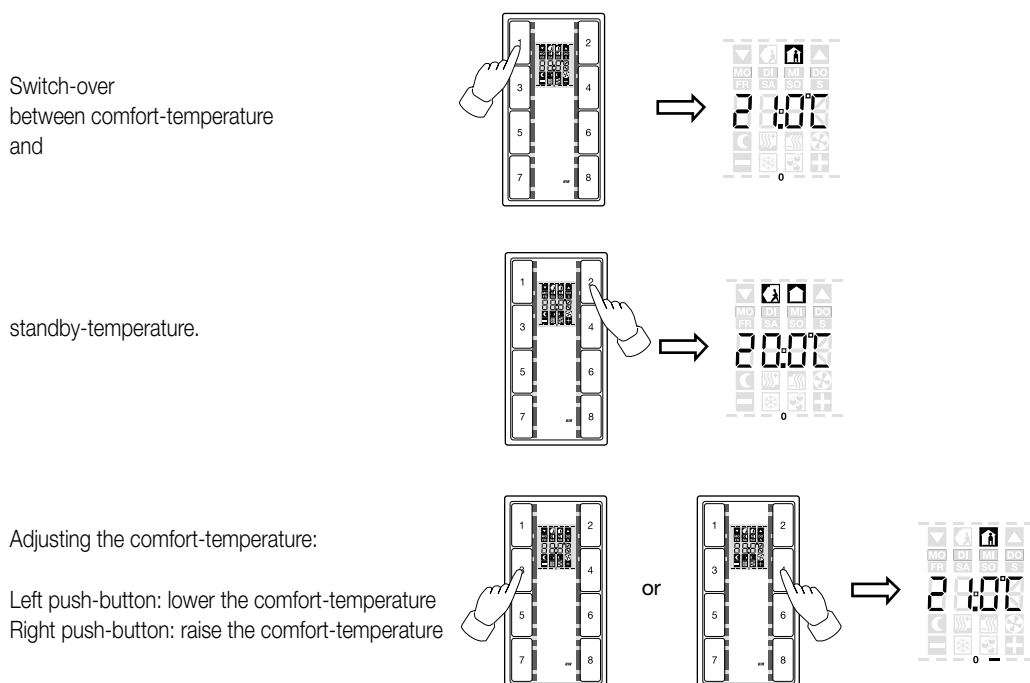

5 Description of software application:

2. Operation level:
- First display in this level can be parameterized
 - First pair of push-buttons: scroll function of the operation modes with their corresponding temperatures values, as comfort temperature, standby / night shift back, display contrast and display segment test
 - Second pair of push-buttons: adjustment of the different functions
 - Rest of the push-buttons: no function

Via long push-button action (> 3 s) of push-button 1 + 2 the device switches over to the 2nd operation level. In this operation level the set-values of the continuous regulator and the contrast of the LC-Display can be adjusted. Scroll through the menu using push-buttons next to ▲ / ▼ symbols.

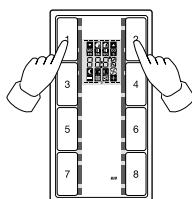

While the display flashes, the set-values can be adjusted. With the push-buttons next to the ± symbols the values can be changed.

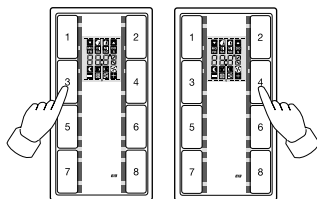

Long push-button action (> 3s) of the push-buttons 1 + 2:
Storing and back to operation level 1.

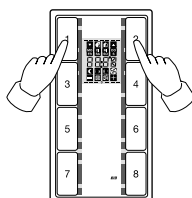

The first indication of the display in the 2nd operation level can be parameterised. Hence the menu guidance can differ from the display at the device.

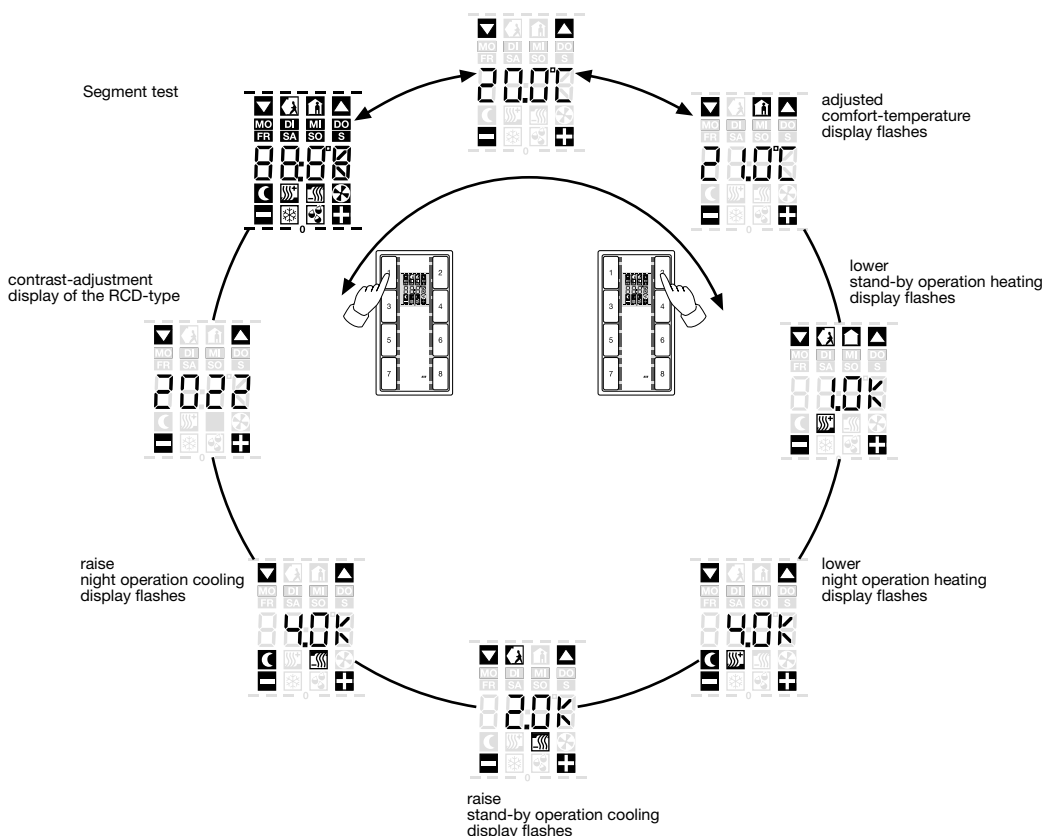

5 Description of software application:

A) Enable / disable function:

It is possible to disable single push-buttons or all push-buttons. When a disabled push-button is pressed (or released) there is either no reaction or a command, which is normally released by another push-button.

Furthermore, there are parameters to define telegrams even during the blocking and at the end of blocking.

B) Shutter / blind operation modes:

Concept 1: Step-Move-Step („normal universal push-button concept“).

A push-button (PB) action causes a step telegram. The step-move time (T1) runs. Releasing the push-button within T1 causes no further telegram. By pressing the PB longer than T1, a move telegram will be send, the louvres adjustment time (T2) starts. Releasing the PB within T2 causes a step telegram while pressing longer than T2 causes no further telegram.



Concept 2: Move-Step

A PB action causes a move telegram. The louvres adjustment time (T2) runs. Releasing the PB within T2 causes a step telegram while pressing longer than T2 causes no further telegram.

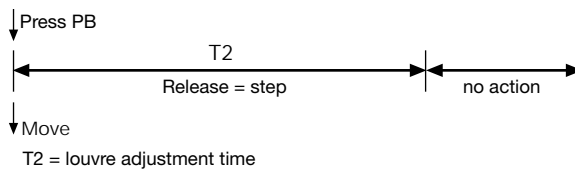

Concept 3: Step-Move

A PB action causes a step telegram. The step-move time (T1) runs. Releasing the PB within T1 causes no further telegram. By pressing the PB longer than T1, a move telegram will be send.

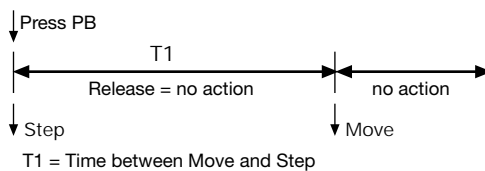

Concept 4: Move-Step or Step

This concept is similar to concept 1. In difference, the first PB action causes no step telegram. The step-move time (T1) starts. Releasing the push-button within T1 causes a step telegram. By pressing the PB longer than T1, a move telegram will be send, the louvres adjustment time (T2) starts. Releasing the PB before T2 is finished causes a step telegram while pressing longer than T2 causes no further telegram.



T1 = Time between Move and Step

T2 = Louvre adjustment time

5 C) Fan coil control

The use of fan coil control requires the “constant PI-control” or the “PWM control” for regulation.

The fan coil control can be carried out:

- Automatically operated
- Manually operated

Automatic operation mode:

The set value of the controller is used for the internal control of the fan level.

When changing between fan levels, it can only be changed to the next higher or lower fan level to secure a possibly required leadtime of the heating/cooling medium.

Manual operation mode:

By means of pressing the button with the function “Manual control” the RCD differs if it is in automatic or manual operation mode.

If it is in automatic operation mode, it will switch into manual operation mode and the fan will be switched OFF.

If the RCD is already in the manual operation mode, it will switch into the next higher fan level.

If the RCD is in the manual operation mode and the fan is in the highest level, the fan will be switched OFF.

Push-button functions “fan level”

The push-button function “fan level” can be parameterised in two ways:

Fan control in automatic operation mode or fan control in manual operation mode

By means of pressing the button with the function “automatic”, the automatic operation mode will be active.

By means of pressing the button with the function “manual control”, the manual operation mode will be active.

The push-button function “fan level” has no communication objects. This function refers directly to the object values and the automatic object.

Indication on Display

When the fan is running, a symbol for the fan appears in the display of the RCD. The actual fan level will be displayed in the upper segment line from right to the left.

For example the fan level 3 will be displayed with the 3 upper segments on the right side.

Forced position

With the parameter “forced position” a specific fan levels can be predefined. When the respective object receives the value 1, the “forced position” is activated. Then only the predefined fan level is activated and can not be changed with automatic or manual operation mode to another fan level. When the respective object receives the value 0, the “forced position” is deactivated.

Level restriction

With the parameter “level restriction” a maximum fan level can be predefined. When the respective object receives the value 1, the “level restriction” is activated.

Only the predefined level and lower fan levels can be selected with the automatic or manual operation mode. (Exception: Forced position)

If a higher fan level is switched on before activation of the “level restriction”, the parameterised fan level will be activated.

Switching of operation modes (fan)

The switch over between manual and automatic operation mode will be enabled via:

switch objects (1 bit)

value objects (1 byte)

Fan level switching via switch object (1 bit)

Each fan level has a switch object. When changing between fan levels, the active fan level will be switched off before the new selected fan level will be switched on.

The switch objects of the respective switch actuator are only allowed to be switched from the RCD. Only the RCD should be able to send writing telegrams.

Fan level switching via value object (1 byte)

Each fan level is assigned to one value of the value object (see chart). The respective switch actuator must be able to read values of the 1 byte object to switch the desired fan level contact. Only the RCD should be able to send writing telegrams.

Object No. 89 “Fan, fan level 1 – 3 (4)”

Object value	Fan level
0	OFF level
1	Level 1
2	Level 2
3	Level 3
4	Level 4
5	

5

D) First operation level

In the first operation level it is possible to parameterise up to 5 indications. If more than 1 indication is parameterised, these will alternate.

In the first operation level can be displayed:

- Actual value
- Set value
- Date
- Time
- External value

For better identification of actual and setpoint temperature an additional "s" is indicated in the display together with the set temperature.

The external value can be displayed in format 1 byte or 2 byte. It can be added a leading sign or a measuring unit. When the external value is displayed, all other display symbols are not indicated. The external value will always be displayed without decimal places. The range of values depends on the parameterisation.

Range of values (1 byte)

	with measuring unit	without measuring unit
With leading sign	-99 ... 99	-128 ... 127
Without leading sign	0 ... 255	0 ... 255

Range of values (2 byte)

	with measuring unit	without measuring unit
With leading sign	-99 ... 99	-999 ... 999
Without leading sign	0 ... 999	0 ... 9999

E) Second operation level

In the second operation level the switch over between standby and comfort mode can be released with the parameter "changing of operation mode in operation level 2". If the changing is released, the operation mode can be switched over in the second display of the second operation level.

Consideration of outdoor temperature

If the parameter "Consideration of outdoor temperature" will be parameterised with "yes", the ECON generates the object "outdoor temperature" (object 95) of type EIS 5. The connected function limits the setting of the setpoint temperature to max. 6 Kelvin. This also means, that the setpoint temperature will be adjusted to the outdoor temperature (outdoor temperature minus 6 K).

This parameter and the connected functionality is only visible, if the operation mode "cooling" or "heating & cooling" is parameterised.

Commissioning note:

When an ETS project with an RCD has to be exported and imported into another PC, please ensure that the software is also installed on the target PC!

6 Symbols

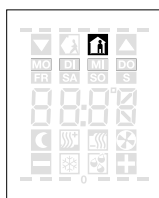

Comfort mode

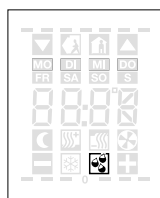

Heat protection
(dew point)

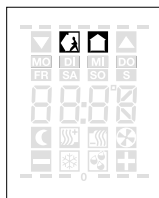

Standby mode

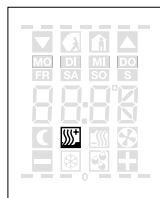

Heating

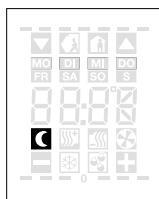

Night mode

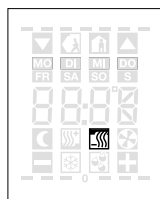

Cooling

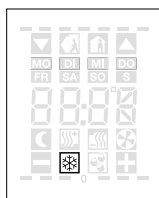

Frost protection



Date, time or
temperature display

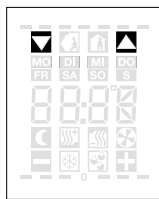

Menu operation

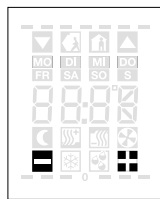

Set point adjustment

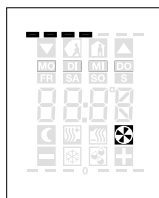

Step 1 - 4
FanCoil



Set temperature

FD Room controller

LS 990 / LS plus

Stainless Steel / Aluminium / Anthracite

1



2

		Ref.-No.
KNX FD room controller display (RCD)		
ETS-product family:	Heating, A/C, ventilation or push-button	
Product type:	Regulator or temperature	
FD RCD 4-gang	ivory	RCD 3094 M
	white	RCD 3094 M WW
	light grey	RCD 3094 M LG
	stainless steel	RCDES 3094 M
	aluminium	RCDAL 3094 M
	anthracite	RCDAL 3094 M AN
FD RCD 6-gang	ivory	RCD 3096 M
	white	RCD 3096 M WW
	light grey	RCD 3096 M LG
	stainless steel	RCDES 3096 M
	aluminium	RCDAL 3096 M
	anthracite	RCDAL 3096 M AN

3

- The KNX FD room controller display (RCD) combines three devices:
- Universal FD push-button functions including light scene plus additional features.
 - Room temperature controller with continuous PI control , switching PI control (pulse width modulation) or a switching two-step control for heating or cooling and additional heating/cooling system, plus additional features.
 - Fan coil application with up to 4 fan speeds and auto function.
 - LCD display is freely programmable (14 byte string text) with up to 4 pages with up to 3 lines. After push an info text with status indication (pop-up text) can be displayed as an option instead an inscription on the rockers.

Via corresponding symbols the different operation modes are indicated. The device has a blue operation LED and each push-button has its own red status LED with the option of an own communication object.

The key arrangement (operation) is optional either top / bottom or left / right.

The device comes with a v4 data base which includes the plug-in software already which makes the handling more easier.

The room controller can be extended with additional FD push-buttons by using 3- to 5-gang frames and can be implemented in the various LS design range by means of using the twistable supporting frame.

The BCU is already integrated into the device.

Note: Due to the dynamic software it is recommended to check the latest software status on our web-page: www.jung.de.

Attention: The software requires at least the ETS 3 version d !

4 Technical data

KNX Supply	
Voltage:	21 – 32 V DC
Power consumption:	typ. 150 mW
Connection:	bus terminal (KNX type 5.1)
Protection:	IP 20
Operation temperature:	-5°C ... +45°C
Storage temperature:	-25°C ... +75°C (storage above +45 °C results in shorter life time)
Type of fastening:	Fixing to the supporting frame by means of the attached plastic screws

Connection and mounting of the FDRCD ..309x M.:

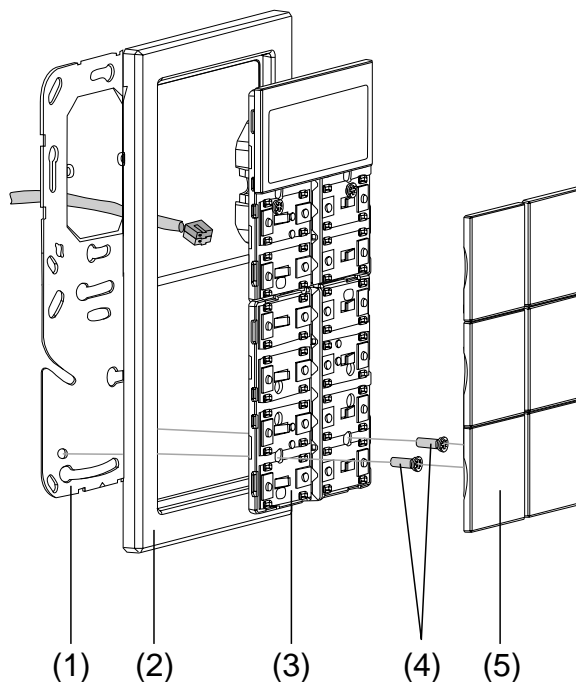

- Metal supporting frame (1) to be mounted on a wall box. Marking "TOP" = on top; "A" in front for FD frame or "B" in front for LS 990, LS plus frame.
- Attach design-frame (2) onto the supporting frame.
- Connect FD RCD module (3) with standard bus connector to the KNX and attach it to the supporting frame.
- When mounting on a single wall box (no wall box under the lower part) generate space for the lower plastic screws in the wall, approx. 10 mm (e.g. drill 6 mm). Use the supporting frame for positioning.
- Fix the FD RCD module (3) to the supporting frame by means of the plastic screws (4) → dismantling / burglar protection. Screw the plastic screws slightly only.
- Download the physical address into the device before mounting the design covers (5).

Note: Do not mount the device next to heat sources due to the influence of the integrated temperature sensor !

5 Description of software application:

During printing stage the technical manual was not yet available.
 For further description of the application please refer to the FD universal push-button ref.-no. 309x TSM and the room temperature controller 2178.
 The complete documentation will be available for download on our web-page.

Flat Design RCD, 6-gang

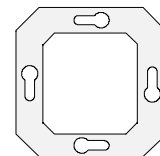

Sensor

Product name:	Room Controller
Design:	flush-mounting device (FMD)
Article. no.	RCD 3096 M .. / RCD .. 3096 M ..
ETS search path:	<ul style="list-style-type: none"> • Heating, Ventilation, Air Conditioning / Controller / RCD flat x-fold (x = 4, 6) and • Pushbutton / Pushbutton, general / RCD flat x-fold (x = 4, 6)
Status:	28.03.2007
Functions:	
Room controller functions	
<p>On the press of a key and depending on the ETS parameter settings, the room controller transmits telegrams to the KNX / EIB. These telegrams can be used, for instance, for switching or momentary-contact control, for dimming or for blind/shutter control. It is also possible to program value transmitter functions such as dimming value transmitters, light-scene extensions, temperature value transmitters or brightness value transmitters. Each of the control surfaces of the room controller can be optionally used as a rocker or as two independent keys. The control surface itself can be divided into vertical or horizontal surfaces. When a control surface is configured as a rocker, it is also possible with some functions to trigger special functions by a press on the whole surface of the rocker.</p> <p>The room controller is equipped with two status LEDs per control surface. These status LEDs can optionally either be permanently on or off, or otherwise act as an actuation or status indicator for a key or a rocker. As an alternative, the LED can also be controlled via separate communication objects. The status LEDs can then also signal the operating states of room temperature controllers or indicate the results of logic value comparisons. A blue operation LED can optionally serve as an orientation light (steady or also flashing) or be controlled via an independent communication object. When the room controller is in the programming mode, the operation LED flashes with a frequency of about 8 Hz. The same flashing rate is also used for indicating that a rocker has been actuated by a press on the full surface; in this case the flashing rate returns to the programmed behaviour after the actuation. If no or a wrong application has been loaded into the room controller, the operation LED flashes with a frequency of abt. 0.75 Hz to indicate an error and the room controller does not work.</p>	
Room temperature controller functions:	
<p>The room controller can be used to control the temperature of individual rooms. Depending on the control option, the current temperature-setpoint and the room temperature, the controller can transmit actuating variables for the control of heating or cooling systems to the KNX / EIB.</p> <p>The room temperature can be sensed by the internal temperature sensor or also by a combination consisting of the internal sensor and external sensor. As a supplement to basic heating or cooling, an additional stage can also be activated. The temperature setpoint difference between the basic and the additional stage can be preset. For larger deviations between the setpoint and the actual temperature value, the room can therefore be heated up or cooled down more quickly by switching on the additional stage. The basic and the additional stage can have different control algorithms assigned to them. The controller can operate in 5 operating modes (comfort, standby, night, frost/ heat protection and controller disable) each having their own temperature setpoints for the heating mode or cooling mode. For the heating and cooling functions continuous-action or switching PI or switching 2-state control characteristics can be selected.</p> <p>In conjunction with a room temperature controller equipped with a 1-byte object for switching over the modes of operation the room controller can be used as a full-featured controller extension unit. The device can also be used for presence detection or for reference value shifting purposes. The integrated temperature sensor allows measuring and transmitting of the room temperature. Central heating control units that are not equipped with a temperature sensor of their own can thus be integrated into the KNX / EIB room temperature control chain.</p>	

Display functions:

The upper part of the room controller display is a graphic display with 132 x 30 pixels. In this section, two or three rows of text can be displayed. The lower half of the display contains fixed symbols indicating the different operating modes of the room controller. The display backlighting can be switched on and off and its brightness can be varied.

The room controller is equipped with an internal BCU and can be connected directly to the bus line (cf. wiring diagram). The room controller is fastened on a supporting ring with plastic screws supplied with the device.

Article numbers:

Room Controller Variant	Jung article no.	ELKA article no.
Room Controller 4-fold	RCD .. 3094 M ..	13557510
Room Controller 6-fold	RCD .. 3096 M ..	13557510

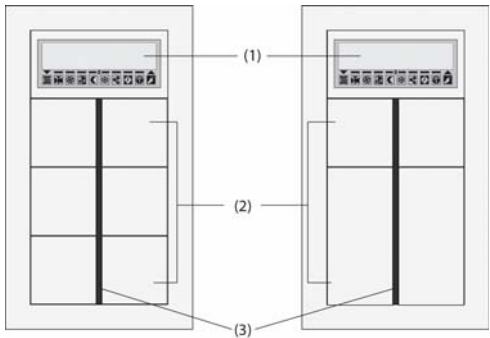
Illustration: 	Dimensions: Width: 70 mm (without frame) Height: 140 mm (without frame) Depth: 20 mm (including flush-mounting box)	Controls: (1) LC-Display (2) Room controller keys (3) Status LED (red) and operation LED (blue)
Technical data		
Type of protection: Safety class: Mark of approval: Ambient temperature: Storage / transport temperature: Mounting position: Minimum distances: Type of fastening:	IP 20 III KNX / EIB -5 °C ... +45 °C -25 °C ... +70 °C (storage above +45 °C reduces the lifetime) any none fastened on the supporting ring with plastic screws supplied with the device.	
KNX / EIB supply Voltage: current rating: Connection:	21 – 32 V DC (SELV) max. 20 mA bus connecting terminal (KNX type 5.1)	
External supply	---	
Internal temperature sensor: Measuring range: Resolution: Air humidity:	+ 5 °C ...+ 35 °C ±1 % 0.1 K 0 % ... 95 % (no condensation)	

Response to bus voltage failure**Bus voltage only:**

object values will be deleted, LEDs extinguished
room temperature controller: no response, control off

Behaviour on return of bus voltage**Bus voltage only:**

room temperature controller: the controller is initialized; depending on parameterization, different temperature values and the status will be transmitted and the switch-over objects will be updated.

Wiring diagram and terminals:

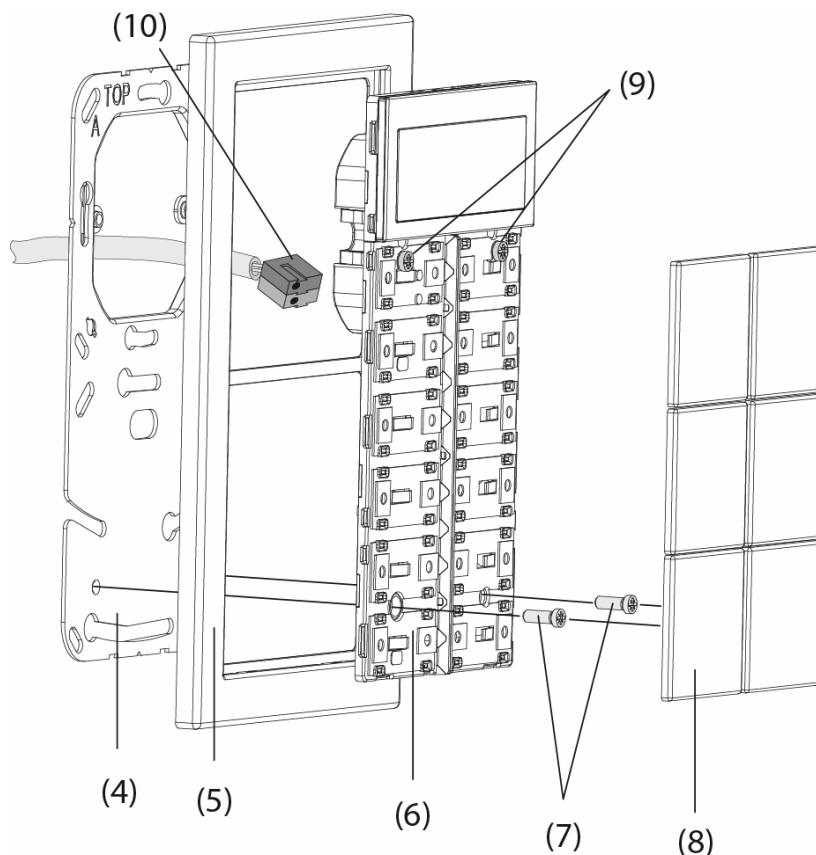

Fitting:

1. Fit supporting ring (4) in correct position on a flush-mounting box (DIN 49073) ("TOP" mark = up; "Type A" - supporting ring side A for FD design - or "Type B" - supporting ring side B for LS design - in front). Use the screws supplied with the box.
2. Place decorative frame (5) on the supporting ring.
3. Connect the room controller module (6) with the standard bus connecting terminal (10) to the KNX/EIB and plug onto supporting ring (leading the bus wires out at the bottom).
4. Fasten the room controller module with the plastic screws supplied (7 and 9) on the supporting ring (protection against removal or theft; to prevent damage to the device resulting from electrostatic charges use the plastic screws without using force (!)).
5. Before fitting the covers (8) load the physical address into the device (cf. "Commissioning").

If the device is fitted only on a flush-mounting box, the screws (7) must be sunk in the wall, e.g. by providing a borehole of $\varnothing 6 \times 10$ mm.

Use the supporting ring as a template.

Fitting of the key covers:

Place the covers one by one on the room controller module. In the correct position the cover can be snapped on with a brief press.

Commissioning

After connection of the room controller to the bus and after fitting it can be put into operation. The start-up procedure is basically confined to programming with the ETS.

I. Assignment of the physical address

The room controller is equipped with an integrated BCU. The room controller has no separate programming key or LED. The programming mode is activated by a defined and time-delayed press of the first rocker and signalled by the operation LED. For programming of the physical address, the module covers must not be in place on the device.

The physical address is programmed as described below...

Activate the programming mode (cf. Fig.1):

- Press button (11) and keep it pressed.

Then - depending on the variant - press

> the square cover at the top left: key (12)

> press the rectangular cover top left: key (13).

The programming mode is activated. The blue operation LED flashes fast (approx. 8 Hz).

Important:

For pressing the keys use suitable tools (e.g. small screwdriver, tip of ballpoint pen, etc.)

- To exclude any inadvertent activation of the programming mode during a 'normal' use of the control surface in operation later on, the time between the first and the second key actuation must be at least 200 ms. A simultaneous press of both keys (time between first and second key-press < 200 ms) will not result in an activation of the programming mode.

- It should be noted that the operation LED starts flashing fast also in case of a full-surface actuation of rocker 1 (cf. functional description). The difference between fast flashing in this case and fast flashing in the programming mode is that - in case of a full-surface actuation of the rocker - the flashing rate falls back into the programmed basic behaviour when the key is released. In the programming mode, the flashing rate remains the same until the mode is ended. The state of the LED defined by the programming mode will always prevail.

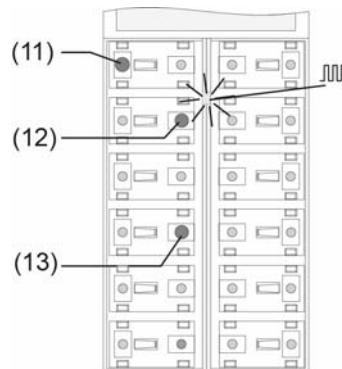

Fig. 1: Keys for activation of the programming mode

1. Program the physical address with the help of the ETS.

2. The programming mode ends:

- automatically after adoption of the physical address

- by pressing a key.

Important:

- If the programming mode is to be activated or deactivated in a device which is already programmed with a valid application, there is the possibility that telegrams will be transmitted to the bus in that instant when a key is being pressed. The telegram transmitted depends on the key function programmed.

II. Programming of the application

The application is to be programmed thereafter into the device with the help of the ETS. The ETS3.0 from version "d" with Service Release "A" onwards detects automatically whether a valid application has already been programmed into the device before. To reduce the programming time, the ETS3 downloads the whole application only if the device was programmed beforehand with another application or with no application at all. In all other cases, the ETS makes a time-optimized partial download in which only the modified data are loaded into the device.

For commissioning operations, the ETS3.0 from version "d" onwards with service release "A" is required.

As-supplied state and non-operational application

As long as pushbutton sensor Universal TSM has not yet been programmed with application data by means of the ETS, the blue operation LED flashes at a slow rate (approx. 0.75 Hz). When any of the keys or rockers is pressed, the pertaining status LED lights up briefly (key-press indication). This state persists until the application is programmed into the device.

By slow flashing of its operation LED (approx. 0.75 Hz), the device can also indicate that it was programmed with a non-executable application by the ETS. Applications are non-executable, if they are not intended for use with the room controller in the ETS product database. Attention must also be paid to the fact that the room controller variant is compatible with the one in the project (e. g. if a 6-fold version is designed in the ETS project, a 6-fold version must be installed and also programmed).

The operation LED flashes slowly even if the application program of the room controller has been removed from the device by the ETS.

In both cases, the room controller is not operational.

Hardware information

Software description

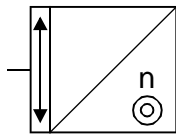
ETS search path: <ul style="list-style-type: none"> • Heating, Ventilation, Air Conditioning / Controller / RCD x-fold (x = 4, 6) and • Pushbutton / Pushbutton, general / RCD flat x-fold (x = 4, 6) 	ETS search path: 
--	---

BAU used: TPUART + µC (Mask 0705 Light)

KNX/EIB type class: 3b – Device with cert. PhL + stack

Configuration: S-mode standard

PEI Type 00_{Hex} 0 Dec

PEI connector no connector

Applications:

No.	Short description:	Name:	Version:
1	none	RCD flat 6-fold RCD flat 4-fold	0.1 / from ETS3.0d: SRA

Application:	RCD flat 6-fold		
Executable from mask version:	7.05		
Number of addresses (max):	254	dynamic table management:	Yes No
Number of assignments (max):	255	Maximum table length:	
Communication objects:	156 (maximum object number 155, gaps in between)		





















Rocker 1...6 2

Object ³	Function	Name:	Type	DP-ID	Flag
0	Switching	P. rocker 1	1 bit	1.xxx	C, W, T, (R) ¹
0	Status-LED top	P. rocker 1	1 bit	1.xxx	C, W (,R) ¹
0	Short-time operation	P. rocker 1	1 bit	1.007	C, T, (R) ¹
0	Value	P. rocker 1	1 byte	5.xxx	C, W, T, (R) ¹
0	Value	P. rocker 1	2 byte	7.xxx	C, W, T, (R) ¹
0	Temperature value	P. rocker 1	2 byte	9.001	C, W, T, (R) ¹
0	Brightness value	P. rocker 1	2 byte	9.004	C, W, T, (R) ¹
0	Scene extension	P. rocker 1	1 byte	18.001	C, T, (R) ¹
0	Channel 1 switching	P. rocker 1	1 bit	1.xxx	C, W, T, (R) ¹
0	Channel 1 value	P. rocker 1	1 byte	5.xxx	C, T, (R) ¹
0	Channel 1 value	P. rocker 1	2 byte	9.001	C, T, (R) ¹
1	Switching	P. rocker 1 full-face actuation	1 bit	1.xxx	C, W, T, (R) ¹
1	Scene extension	P. rocker 1 full-face actuation	1 byte	18.001	C, T, (R) ¹
1	Status LED bottom	P. rocker 1	1 bit	1.xxx	C, W (,R) ¹
18	Dimming	P. rocker 1	4 bit	3.007	C, W, T, (R) ¹
18	Long-time operation	P. rocker 1	1 bit	1.008	C, W, T, (R) ¹
18	Channel 2 switching	P. rocker 1	1 bit	1.xxx	C, W, T, (R) ¹
18	Channel 2 value	P. rocker 1	1 byte	5.xxx	C, T, (R) ¹
18	Channel 2 value	P. rocker 1	2 byte	9.001	C, T, (R) ¹
36	Status-LED top	P. rocker 1	1 bit	1.xxx	C, W (,R) ¹
36	Status-LED top	P. rocker 1	1 byte	20.102	C, W (,R) ¹
36	Status-LED top	P. rocker 1	1 byte	5.xxx	C, W (,R) ¹
36	Status-LED top	P. rocker 1	1 byte	6.xxx	C, W (,R) ¹
37	Status LED bottom	P. rocker 1	1 bit	1.xxx	C, W (,R) ¹
37	Status LED bottom	P. rocker 1	1 byte	20.102	C, W (,R) ¹
37	Status LED bottom	P. rocker 1	1 byte	5.xxx	C, W (,R) ¹
37	Status LED bottom	P. rocker 1	1 byte	6.xxx	C, W (,R) ¹

¹: The communication objects can be read out (set L-flag).

²: The number of rockers or keys depends on the room controller variant used in the project. Mixed use of rocker and pushbutton functions in one and the same room controller possible.

³: As an example, the objects are described for rocker 1. The objects for the other rockers are defined in the same way by shifting the object number.

Key 1...12 ²						
Object ⁴	Function	Name ⁴	Type	DP-ID	Flag	
 0	Switching	P. key 1	1 bit	1.xxx	C, W, T, (R) ¹	
 0	Status LED	P. key 1	1 bit	1.xxx	C, W (,R) ¹	
 0	Short-time operation	P. key 1	1 bit	1.007	C, T, (R) ¹	
 0	Value	P. key 1	2 byte	5.xxx	C, W, T, (R) ¹	
 0	Value	P. key 1	1 byte	7.xxx	C, W, T, (R) ¹	
 0	Temperature value	P. key 1	2 byte	9.001	C, W, T, (R) ¹	
 0	Brightness value	P. key 1	2 byte	9.004	C, W, T, (R) ¹	
 0	Scene extension	P. key 1	1 byte	18.001	C, T, (R) ¹	
 0	Channel 1 switching	P. key 1	1 bit	1.xxx	C, W, T, (R) ¹	
 0	Channel 1 value	P. key 1	1 byte	5.xxx	C, T, (R) ¹	
 0	Channel 1 value	P. key 1	2 byte	9.001	C, T, (R) ¹	
 18	Dimming	P. key 1	4 bit	3.007	C, W, T, (R) ¹	
 18	Long-time operation	P. key 1	1-bit	1.008	C, W, T, (R) ¹	
 18	Channel 2 switching	P. key 1	1-bit	1.xxx	C, W, T, (R) ¹	
 18	Channel 2 value	P. key 1	1 byte	5.xxx	C, T, (R) ¹	
 18	Channel 2 value	P. key 1	2 byte	9.001	C, T, (R) ¹	
 36	Status LED	P. key 1	1-bit	1.xxx	C, W (,R) ¹	
 36	Status LED	P. key 1	1 byte	20.102	C, W (,R) ¹	
 36	Status LED	P. key 1	1 byte	5.xxx	C, W (,R) ¹	
 36	Status LED	P. key 1	1 byte	6.xxx	C, W (,R) ¹	

¹: The communication objects can be read out (set L-flag).

²: The number of rockers or keys depends on the room controller variant used in the project. Mixed use of rocker and pushbutton functions in one and the same room controller possible.

⁴: As an example, the objects are described for key 1. The objects for the keys 2 ... max. 12 are defined in the same way by shifting the object number.

Disabling functions:						
Object	Function	Name:	Type	DP-ID	Flag	
	16 Switching	P. disabling function 1	1-bit	1.xxx	C, W, T, (R) ¹	
	16 Short-time operation	P. disabling function 1	1-bit	1.007	C, T, (R) ¹	
	16 Value	P. disabling function 1	1 byte	5.xxx	C, W, T, (R) ¹	
	16 Value	P. disabling function 1	2 byte	7.xxx	C, W, T, (R) ¹	
	16 Temperature value	P. disabling function 1	2 byte	9.001	C, W, T, (R) ¹	
	16 Brightness value	P. disabling function 1	2 byte	9.004	C, W, T, (R) ¹	
	16 Scene extension	P. disabling function 1	1 byte	18.001	C, T, (R) ¹	
	16 Channel 1 switching	P. disabling function 1	1-bit	1.xxx	C, W, T, (R) ¹	
	16 Channel 1 value	P. disabling function 1	1 byte	5.xxx	C, T, (R) ¹	
	16 Channel 1 value	P. disabling function 1	2 byte	9.001	C, T, (R) ¹	
	17 Switching	P. disabling function 2	1-bit	1.xxx	C, W, T, (R) ¹	
	17 Short-time operation	P. disabling function 2	1-bit	1.007	C, T, (R) ¹	
	17 Value	P. disabling function 2	2 byte	5.xxx	C, W, T, (R) ¹	
	17 Value	P. disabling function 2	1 byte	7.xxx	C, W, T, (R) ¹	
	17 Temperature value	P. disabling function 2	2 byte	9.001	C, W, T, (R) ¹	
	17 Brightness value	P. disabling function 2	2 byte	9.004	C, W, T, (R) ¹	
	17 Scene extension	P. disabling function 2	1 byte	18.001	C, T, (R) ¹	
	17 Channel 1 switching	P. disabling function 2	1-bit	1.xxx	C, W, T, (R) ¹	
	17 Channel 1 value	P. disabling function 2	1 byte	5.xxx	C, T, (R) ¹	
	17 Channel 1 value	P. disabling function 2	2 byte	9.001	C, T, (R) ¹	
	34 Long-time operation	P. disabling function 1	1-bit	1.008	C, W, T, (R) ¹	
	34 Dimming	P. disabling function 1	4-bit	3.007	C, W, T, (R) ¹	
	34 Channel 2 switching	P. disabling function 1	1-bit	1.xxx	C, W, T, (R) ¹	
	34 Channel 2 value	P. disabling function 1	1 byte	5.xxx	C, T, (R) ¹	
	34 Channel 2 value	P. disabling function 1	2 byte	9.001	C, T, (R) ¹	
	35 Long-time operation	P. disabling function 2	1-bit	1.008	C, W, T, (R) ¹	
	35 Dimming	P. disabling function 2	4-bit	3.007	C, W, T, (R) ¹	
	35 Channel 2 switching	P. disabling function 2	1-bit	1.xxx	C, W, T, (R) ¹	
	35 Channel 2 value	P. disabling function 2	1 byte	5.xxx	C, T, (R) ¹	
	35 Channel 2 value	P. disabling function 2	2 byte	9.001	C, T, (R) ¹	
	54 Disabling	P. key disable	1-bit	1.001	C, W, (R) ¹	

¹: The communication objects can be read out (set L-flag).

Operation LED						
<input type="checkbox"/>	52	Switching	T. operation LED	1-bit	1.001	C, W (,R) ¹
Alarm message:						
Object	Function	Name:	Type	DP-ID	Flag	
<input type="checkbox"/>	56	Switching	P. alarm message	1-bit	1.xxx	C, W (,R) ¹
<input type="checkbox"/>	57	Switching	P. alarm signalling acknowledge	1-bit	1.xxx	C, T, (R) ¹
Controller extension:						
Object	Function	Name:	Type	DP-ID	Flag	
<input type="checkbox"/>	58	Operating mode switch-over	P. controller extension	1 byte	20.102	C, W, T, R
<input type="checkbox"/>	59		P. controller extension	1 byte	20.102	C, W, T, R
<input type="checkbox"/>	60	Presence key	P. controller extension	1-bit	1.001	C, W, T, R
<input type="checkbox"/>	61	Setpoint shift output	P. controller extension	1 byte	6.010	C, W, T, R
<input type="checkbox"/>	62	Setpoint shift input	P. controller extension	1 byte	6.010	C, W, T, R
<input type="checkbox"/>	63	Controller status	P. controller extension	1 byte	undefined	C, W, T, (R) ¹
<input type="checkbox"/>	64	Actual temperature	P. temperature measurement	2 byte	9.001	C, T, (R) ¹
<input type="checkbox"/>	65	External temperature	P. external temperature sensor	2 byte	9.001	C, W, (R) ¹
Scene control						
Object	Function	Name	Type	DP-ID	Flag	
<input type="checkbox"/>	66	Switching	P. scene output 1 ⁵	1-bit	1.001	C, W, T, (R) ¹
<input type="checkbox"/>	66	Value	P. scene output 1 ⁵	1 byte	5.xxx	C, W, T, (R) ¹
<input type="checkbox"/>	66	Value	P. scene output 1 ⁵	1 byte	5.001	C, W, T, (R) ¹
<input type="checkbox"/>	74	Extension input	P. scenes	1 byte	18.001	C, W (,R) ¹
<p>¹: The communication objects can be read out (set L-flag).</p> <p>⁵: Scene outputs 2 ... 8 see scene output 1 taking into consideration an object number shift (66 + number of scene output - 1).</p>						

Room temperature controller functions:						
Object	Function	Name	Type	DP-ID	Flag	
80	Basic setpoint	C. input	2 byte	9.001	C, W	
82	Operating mode switch-over	C. input	1 byte	20.102	C, W, T, R	
82	Comfort mode	C. input	1-bit	1.001	C, W, T	
83	standby mode	C. input	1-bit	1.001	C, W, T	
84	Night mode	C. input	1-bit	1.001	C, W, T	
85	Frost/ heat protection	C. input	1-bit	1.001	C, W, T	
86	Operating mode forcing object	C. input	1 byte	20.102	C, W, T, R	
87	Presence object	RTC input / output	1-bit	1.001	C, W, T, R	
88	Window status	C. input	1-bit	1.019	C, W, T, R	
89	Heating/cooling switch-over:	C. input	1-bit	1.100	C, W, T, R	
90	Controller status	RTC output	1 byte	undefined	C, T	
90	Controller status, comfort mode	RTC output	1-bit	1.001	C, T	
90	Controller status, standby mode	RTC output	1-bit	1.001	C, T	
90	Controller status, night mode	RTC output	1-bit	1.001	C, T	
90	Controller status, frost / heat protection	RTC output	1-bit	1.001	C, T	
90	Controller status, controller disabled	RTC output	1-bit	1.001	C, T	
90	Controller status, heating / cooling	RTC output	1-bit	1.001	C, T	
90	Controller status, controller inactive	RTC output	1-bit	1.001	C, T	
90	Controller status, frost alarm	RTC output	1-bit	1.001	C, T	
91	Heating message	RTC output	1-bit	1.001	C, T	
92	Cooling message	RTC output	1-bit	1.001	C, T	
94	Disable controller	C. input	1-bit	1.001	C, W, T, R	
95	Disable additional stage 8	C. input	1-bit	1.001	C, W	
96	Actuating variable heating	RTC output	1 byte	5.001	C, T	
96	Actuating variable heating	RTC output	1-bit	1.001	C, T	
96	Actuating variable basic heating	RTC output	1 byte	5.001	C, T	
96	Actuating variable basic heating	RTC output	1-bit	1.001	C, T	
96	Actuating variable heating/cooling	RTC output	1 byte	5.001	C, T	
96	Actuating variable heating/cooling	RTC output	1-bit	1.001	C, T	
96	Actuating variable basic stage	RTC output	1 byte	5.001	C, T	
96	Actuating variable basic stage	RTC output	1-bit	1.001	C, T	
97	Actuating variable additional heating	RTC output	1 byte	5.001	C, T	
97	Actuating variable additional heating	RTC output	1-bit	1.001	C, T	
97	Actuating variable additional stage	RTC output	1 byte	5.001	C, T	
97	Actuating variable additional stage	RTC output	1-bit	1.001	C, T	
98	Actuating variable cooling	RTC output	1 byte	5.001	C, T	
98	Actuating variable cooling	RTC output	1-bit	1.001	C, T	
98	Actuating variable basic cooling	RTC output	1 byte	5.001	C, T	
98	Actuating variable basic cooling	RTC output	1-bit	1.001	C, T	
99	Actuating variable additional cooling	RTC output	1 byte	5.001	C, T	
99	Actuating variable additional cooling	RTC output	1-bit	1.001	C, T	















Room temperature controller functions (continued):						
Object	Function	Name	Type	DP-ID	Flag	
☐→	100	PWM actuating variable heating	C. output	1 byte	5.001	C, T
☐→	100	PWM actuating variable basic heating	C. output	1 byte	5.001	C, T
☐→	100	PWM actuating variable heating / cooling	C. output	1 byte	5.001	C, T
☐→	100	PWM actuating variable basic stage	C. output	1 byte	5.001	C, T
☐→	101	PWM actuating variable additional heating	RTC output	1 byte	5.001	C, T
☐→	101	PWM actuating variable additional stage	RTC output	1 byte	5.001	C, T
☐→	102	PWM actuating variable cooling	RTC output	1 byte	5.001	C, T
☐→	102	PWM actuating variable basic cooling	RTC output	1 byte	5.001	C, T
☐→	103	PWM actuating variable additional cooling	RTC output	1 byte	5.001	C, T
☐→	104	Setpoint temperature	RTC output	2 byte	9.001	C, T, R
☐→	106	Setpoint shift feedback	RTC output	1 byte	6.010	C, T, R
☐←	107	Setpoint shift preset	C. input	1 byte	6.010	C, W
☐→	108	Status report additional stage	RTC output	1 byte	undefined	C, T
☐→	109	Actual temperature not adjusted	RTC output	2 byte	9.001	C, T
☐↔	110	Ventilation automatic / manual	C. input	1-bit	1.001	C, W, T
☐→	111	Ventilation, fan level 1	C. output	1-bit	1.001	C, T, R
☐→	111	Ventilation, fan level 1 – 8	C. output	1 byte	5.001	C, T, R
☐→	112	Ventilation, fan level 2	C. output	1-bit	1.001	C, T, R
☐→	113	Ventilation, fan level 3	C. output	1-bit	1.001	C, T, R
☐→	114	Ventilation, fan level 4	C. output	1 bit	1.001	C, T, R
☐→	115	Ventilation, fan level 5	C. output	1 bit	1.001	C, T, R
☐→	116	Ventilation, fan level 6	C. output	1 bit	1.001	C, T, R
☐→	117	Ventilation, fan level 7	RC. output	1 bit	1.001	C, T, R
☐→	118	Ventilation, fan level 8	C. output	1 bit	1.001	C, T, R
☐←	119	Ventilation, forced-control	C. input	1 bit	1.001	C, W
☐←	120	Ventilation, level limitation	C. input	1 bit	1.001	C, W
☐←	121	Ventilation, fan protection	C. input	1 bit	1.001	C, W
☐←	122	Outside temperature	C. input	2 byte	9.001	C, W
☐←	123	Cooling setpoint limiting	C. input	1 bit	1.001	C, W
☐←	124	Floor temperature	C. input	2 byte	9.001	C, W
☐←	125	Clock timer channel 1	C. input	1 bit	1.001	C, W
☐←	126	Clock timer channel 2	C. input	1 bit	1.001	C, W
☐←	127	Clock timer channel 3	C. input	1 bit	1.001	C, W
☐←	128	Clock timer channel 4	C. input	1 bit	1.001	C, W

Display functions:						
Object	Function	Name:	Type	DP-ID	Flag	
☐←	130	Time of day	D. input	3 bytes	10.001	C, W
☐←	131	Date	D. input	3 bytes	11.001	C, W
☐→	132	Request date/time of day	D. output	1 bit	1.003	C, T
☐←	133	Backlighting on/off	D. input	1 bit	1.001	C, W
☐←	133	Backlighting brightness	D. input	1 byte	5.001	C, W
☐↔	134	Info-mode:	D. input/output	1 bit	1.001	C, W, T
☐←	135	Fixed page recall	D. input	1 bit	1.001	C, W
☐←	135	Variable page recall	D. input	1 byte	5.010	C, W
☐←	136	Switching	D. input [page 1 line 1] ⁶	1 bit	1.001	C, W
☐←	136	Value, 1 byte	D. input [page 1 line 1] ⁶	1 byte	5.0xx 6.0xx	C, W
☐←	136	Value, 1 dimming value	D. input [page 1 line 1] ⁶	1 byte	5.001 5.010	C, W
☐←	136	Blind	D. input [page 1 line 1] ⁶	1 bit	1.008	C, W
☐←	136	Light-scene	D. input [page 1 line 1] ⁶	1 byte	18.001	C, W
☐←	136	Value, 2 bytes	D. input [page 1 line 1] ⁶	2 bytes	7.xxx 8.xxx 9.xxx	C, W
☐←	136	Value, 4 bytes	D. input [page 1 line 1] ⁶	4 bytes	12.xxx 13.xxx 14.xxx	C, W
☐←	136	ASCII, 14 bytes	D. input [page 1 line 1] ⁶	14 bytes	16.00x	C, W
☐←	139	Symbol recall page 1	D. input	1 bit	1.001	C, W
☐←	139	Symbol recall page 1	D. input	1 bytes	5.010 ⁷	C, W
☐←	152	Central alarm unit line 1	D. input	14 bytes	16.00x	C, W
☐←	153	Central alarm unit line 2	D. input	14 bytes	16.00x	C, W
☐←	154	Central alarm unit line 3	D. input	14 bytes	16.00x	C, W
☐→	155	Central alarm unit selection	D. output	1 bit	1.001	C, T







⁶: As an example, the objects are described for page 1 line 1. The objects of pages 2 to 4 and of the other lines result from object number shifting.





















⁷: The object has the datapoint type "ShowElementNo". This type corresponds to an integer without sign.

Rocker function object description

	0, 1	Switching	1-bit object for the transmission of switching telegrams (ON, OFF).
	0	Short-time operation	1-bit object for the transmission of telegrams with which a blind or shutter drive motor can be stopped or with which the shutter slats can be adjusted by short-time operation.
	0, 1	Scene extension	1-byte object for recalling or for storing one of 64 scenes max. from a scene pushbutton sensor.
	0	Brightness value	2-byte object for the transmission of a brightness value from 0 lux to 1500. If the variation of the value is enabled, the object can transmit cyclical telegrams after a long press with which the value can be reduced or increased by 50 lux.
	0	Temperature value	2-byte object for the transmission of a temperature value from 0 °C to 40 °C. If the variation of the value is enabled, the object can transmit telegrams cyclically after a long press with which the value can be reduced or increased by 1 K.
	0	Value	1-byte object or 2-byte object for the transmission of values from 0 to 255 (corresponding to values from 0 % to 100 %) or from 0 to 65535. If the variation of the value is enabled, the object can transmit telegrams cyclically after a long press with which the value can be reduced or increased by a presettable amount.
	0	Channel 1 switching	1-bit object for the transmission of switching telegrams, if the 2-channel control is activated.
	0	Channel 1 value	1-byte object or 2-byte object for the transmission of value telegrams, if the 2-channel control is activated.
	36	Top status LED	1-bit object or 1-byte object for controlling the status LED.
	37	Bottom status LED	1-bit object or 1-byte object for controlling the status LED.
	18	Dimming	4-bit object for the transmission of relative dimming telegrams.
	18	Long-time operation	1-bit object for the transmission of telegrams with which a blind or shutter drive can raise or lower the curtain.
	18	Channel 2 switching	1-bit object for the transmission of switching telegrams, if the 2-channel control is activated.
	18	Channel 2 value	1-byte object or 2-byte object for the transmission of value telegrams, if the 2-channel control is activated.

Key function object description

	0	Switching	1-bit object for the transmission of switching telegrams (ON, OFF).
	0	Short-time operation	1-bit object for the transmission of telegrams with which a blind or shutter drive motor can be stopped or with which the shutter slats can be adjusted by short-time operation.
	0	Scene extension	1-byte object enabling the room controller to transmit a telegram to a scene pushbutton sensor for recalling or for storing one of max. 64 scenes.
	0	Brightness value	2-byte object for the transmission of a brightness value from 0 lux to 1500. If the variation of the value is enabled, the object can transmit cyclical telegrams after a long press with which the value can be reduced or increased by 50 lux.
	0	Temperature value	2-byte object for the transmission of a temperature value from 0 °C to 40 °C. If the variation of the value is enabled, the object can transmit telegrams cyclically after a long press with which the value can be reduced or increased by 1 K.
	0	Value	1-byte object or 2-byte object for the transmission of values from 0 to 255 (corresponding to values from 0 % to 100 %) or from 0 to 65535. If the variation of the value is enabled, the object can transmit telegrams cyclically after a long press with which the value can be reduced or increased by a presettable amount.

	0	Channel 1 switching	1-bit object for the transmission of switching telegrams, if the 2-channel control is activated.
	0	Channel 1 value	1-byte object or 2-byte object for the transmission of value telegrams, if the 2-channel control is activated.
	36	Status LED	1-bit object or 1-byte object for controlling the status LED.
	18	Dimming	4-bit object for the transmission of relative dimming telegrams.
	18	Long-time operation	1-bit object for the transmission of telegrams with which a blind or shutter drive can raise or lower the curtain.
	18	Channel 2 switching	1-bit object for the transmission of switching telegrams, if the 2-channel control is activated.
	18	Channel 2 value	1-byte object or 2-byte object for the transmission of value telegrams, if the 2-channel control is activated.
Disabling function object description			
	16, 17	Switching	1-bit object for the transmission of switching telegrams (ON, OFF).
	16, 17	Short-time operation	1-bit object for the transmission of telegrams with which a blind or shutter drive motor can be stopped or with which the shutter slats can be adjusted by short-time operation.
	16, 17	Scene extension	1-byte object enabling the room controller to transmit a telegram to a scene pushbutton sensor for recalling or for storing one of max. 64 scenes.
	16, 17	Brightness value	2-byte object for the transmission of a brightness value from 0 lux to 1500. If the variation of the value is enabled, the object can transmit cyclical telegrams after a long press with which the value can be reduced or increased by 50 lux.
	16, 17	Temperature value	2-byte object for the transmission of a temperature value from 0 °C to 40 °C. If the variation of the value is enabled, the object can transmit telegrams cyclically after a long press with which the value can be reduced or increased by 1 K.
	16, 17	Value	1-byte object or 2-byte object for the transmission of values from 0 to 255 (corresponding to values from 0 % to 100 %) or from 0 to 65535. If the variation of the value is enabled, the object can transmit telegrams cyclically after a long press with which the value can be reduced or increased by a presettable amount.
	16, 17	Channel 1 switching	1-bit object for the transmission of switching telegrams, if the 2-channel control is activated.
	16, 17	Channel 1 value	1-byte object or 2-byte object for the transmission of value telegrams, if the 2-channel control is activated.
	34, 35	Dimming	4-bit object for the transmission of relative dimming telegrams.
	34, 35	Long-time operation	1-bit object for the transmission of telegrams with which a blind or shutter drive can raise or lower the curtain.
	34, 35	Channel 2 switching	1-bit object for the transmission of switching telegrams, if the 2-channel control is activated.
	34, 35	Channel 2 value	1-byte object or 2-byte object for the transmission of value telegrams, if the 2-channel control is activated.
	54	Disable	1-bit object with which the room controller can be disabled and re-enabled (polarity can be parameterized).
Operation LED object description			
	52	Switching	1-bit object for switching the operation LED on or off ("1" = on; "0" = off).

Alarm message object description

□←	56	Switching	1-bit object for the reception of an alarm message (polarity can be parameterized).
□→	57	Switching	1-bit object for transmitting the alarm message acknowledgement (polarity can be parameterized)

Controller extension object description

□←	58	Operating mode switch-over	1-byte object for switching over a room temperature controller between the comfort, standby, night and frost / heat protection operating modes
□→	59	Forced operating mode switch-over	1-byte object for switching over a room temperature controller between the comfort, standby, night and frost / heat protection operating modes
□→	60	Presence key	1-bit object for switching over the presence status of a room temperature controller (polarity can be parameterized).
□→	61	Setpoint shift output	1-byte object for presetting a basic setpoint shift for a controller. $x \leq 0 \leq y$ (0 = no active shifting); integers Value object 62 + 1 (increase step value) Value object 62 + 1 (decrease step value) The possible range of values (x to y) is fixed by the setpoint adjusting range to the 'upper limit' or to the 'lower limit' (parameterizable) in combination with the step value <u>on the room temperature controller</u> .
□→	62	Setpoint shift input	1-byte object used by the extension for receiving the current setpoint shift of the room temperature controller $x \leq 0 \leq y$ (0 = no active shifting); integers The possible range of values (x to y) is fixed by the setpoint adjusting range to the 'upper limit' or to the 'lower limit' (parameterizable) in combination with the step value <u>on the room temperature controller</u> .
□→	63	Controller status	1-byte object used by the extension for receiving the current state of operation of the controller. Status LEDs that can be used to indicate a status independently of a key function can display one of the various information units which are grouped in this byte (bit-oriented evaluation).
□→	64	Actual temperature	2-byte object for the transmission of the measured temperature. When evaluating the room temperature, the room controller can optionally use only the internal sensor or also the value measured by an external sensor.
□→	65	External temperature	2-byte object with which the room controller can receive or scan the temperature value of an external sensor.

Object description for scene control

□←	66...73	Switching	1-bit objects for controlling up to 8 actuator groups (ON, OFF).
□←	66...73	Value	1-byte objects for controlling up to 8 actuator groups (0...255).
□←	74	Extension input	1-byte object with which one of the eight internally stored scenes can be recalled or stored again.

Room temperature controller object description

□←	80	Basic setpoint:	2-byte object for external preset of basic setpoint. Depending on the control option, the possible range of values is limited by the parameterized frost protection and/or heat protection temperature. The received value is mathematically rounded off to half °C!
□←	82	Operating mode switch-over:	1-byte object for switch-over of the controller's operating modes acc. to KONNEX.
□←	82	Comfort operation:	1-bit object for switch-over into the "Comfort" operating mode.
□←	83	Standby operation:	1-bit object for switch-over into the "standby" operating mode.
□←	84	Night-time operation:	1-bit object for switch-over into the "night" operating mode.
□←	85	Frost / heat protection	1-bit object for switch-over into the "frost/heat protection" operating mode.
□←	86	Forced-control object operating mode:	1-byte object for higher-level forced control of the controller's operating modes acc. to KONNEX.
□↔	87	Presence object:	1-bit object (bi-directional) which transmits the status of the presence key - to the bus after pressing or which can be used for connection of a presence detector. (presence detected = "1", presence not detected = "0")
□←	88	Window status:	1-bit object for the connection of window contacts. (window open = "1", window closed = "0")
□↔	89	Heating / cooling change-over:	1-bit object for switching over between control options "heating" and "cooling, if not done by the controller automatically (object value 1: heating; object value 0: cooling). In case of automatic switch-over the active control option can be transmitted (parameter-dependent).
□→	90	Controller status:	1-byte object for general status feedback
□→	90	Controller status ...:	1-bit object for individual status feedback of parameterizable functions of the controller (frost alarm, heating/cooling, comfort mode, night mode, standby mode, controller disabled, controller inactive, frost/heat protection).
□→	91	Message heating:	1-bit object for the controller to indicate a request for heating energy (object value = "1": energy requested, object value = "0": no energy requested).
□→	92	Message cooling:	1-bit object for the controller to indicate a cooling energy request (object value = "1": energy requested, object value = "0": no energy requested).
□←	94	Controller disable:	1-bit object for deactivating the controller (activation of dew-point operation). (controller deactivated = "1", controller activated = "0")
□←	95	Disable additional stage:	1-bit object for deactivating the additional stage of the controller. (additional stage deactivated = "1", additional stage activated = "0")

Room temperature controller object description

☐→	96	Actuating variable heating	1-byte object for outputting the continuous actuating variable for heating operation
☐→	96	Actuating variable heating:	1-bit object to output the switching actuating variable or PWM actuating variable used for the heating operation.
☐→	96	Actuating variable basic heating:	1-byte object to output the continuous actuating variable for basic heating operation.
☐→	96	Actuating variable basic heating:	1-bit object to output the switching actuating variable or PWM actuating variable used for basic heating.
☐→	96	Actuating variable heating/cooling:	1-byte object to output the continuous actuating variable for heating or cooling operation. (via shared object if actuating variables are output)
☐→	96	Actuating variable heating/cooling:	1-bit object to output the switching actuating variable or PWM actuating variable alternatively for the heating or cooling operation. (via shared object if actuating variables are output)
☐→	96	Actuating variable basic heating and cooling:	1-byte object for the output of the continuous actuating variable either for basic heating or for basic cooling operation. (via shared object if actuating variables are output)
☐→	96	Actuating variable basic heating and cooling:	1-bit object to output the switching actuating variable or PWM actuating variable either for basic heating or basic cooling operation. (via shared object if actuating variables are output)
☐→	97	Actuating variable additional heating:	1-byte object to output the continuous actuating variable for additional heating operation.
☐→	97	Actuating variable additional heating:	1-bit object to output the switching actuating variable or PWM actuating variable for additional heating operation.
☐→	97	Actuating variable additional stage:	1-byte object for the output of the continuous actuating variable either for additional heating or cooling operation (via shared object if actuating variables are output)
☐→	97	Actuating variable additional stage:	1-bit object to output the switching actuating variable or PWM actuating variable either for the heating or cooling operation. (via shared object if actuating variables are output)
☐→	98	Actuating variable cooling:	1-byte object to output the continuous actuating variable for cooling operation.
☐→	98	Actuating variable cooling:	1-bit object to output the switching actuating variable or PWM actuating variable for cooling operation.
☐→	98	Actuating variable basic cooling:	1-byte object to output the continuous actuating variable for basic cooling operation
☐→	98	Actuating variable basic cooling:	1-bit object to output the switching actuating variable or PWM actuating variable for basic cooling operation.
☐→	99	Actuating variable additional cooling:	1-byte object to output the continuous actuating variable for additional cooling operation.
☐→	99	Actuating variable additional cooling:	1-bit object to output the switching actuating variable or PWM actuating variable for additional cooling operation.
☐→	100	PWM actuating variable heating:	1-byte object with PWM actuating variable for status feedback of the actuating variable value for heating operation.
☐→	100	PWM actuating variable basic heating:	1-byte object with PWM actuating variable for status feedback of the continuous actuating variable value for basic heating operation
☐→	101	PWM actuating variable additional heating:	1-byte object with PWM actuating variable for status feedback of the continuous actuating variable value for additional heating.
☐→	102	PWM actuating variable cooling:	1-byte object with PWM actuating variable for status feedback of the continuous actuating variable value for cooling operation.
☐→	102	PWM actuating variable basic cooling:	1-byte object with PWM actuating variable for status feedback of the continuous actuating variable value for basic cooling operation

Room temperature controller object description

☐→	103	PWM actuating variable additional cooling:	1-byte object with PWM actuating variable for status feedback of the continuous actuating variable value for additional cooling operation
☐→	104	Setpoint temperature:	2-byte object to output the current temperature setpoint value. Depending on the control option, the possible range of values is limited by the parameterized frost protection and/or heat protection temperature.
☐→	106	Feedback setpoint shift:	1-byte object for current setpoint shift feedback $x \leq 0 \leq y$ (0 = no active shifting); integers The possible range of values (x to y) is fixed by the setting of the upper and lower limits for the setpoint (parameterizable) in combination with the step value (0.5 °C).
☐←	107	Setpoint shift default:	1-byte object for presetting a basic setpoint shift, e.g. via a controller extension. $x \leq 0 \leq y$ (0 = no active shifting); integers The possible range of values (x to y) is fixed by the setting of the upper and lower limits for the setpoint (parameterizable) in combination with the step value (0.5 °C). In case the limits of the value range are exceeded by the preset external value, the controller will automatically reset the received value to the minimum and maximum limits.
☐→	108	Additional status indication:	1-byte object for general additional status feedback
☐→	109	Actual temperature non adjusted	2-byte object to output the actual temperature (room temperature) as measured and not adjusted by the controller. (possible range of values: -99.9 °C ... +99.9 °C / Measuring range of internal temperature sensor: 0 °C to + 40 °C ± 1 %)
☐←	110	Ventilation automatic / manual	1-bit object for switching over between automatic and manual fan control. The object values for automatic or manual operation can be preset.
☐→	111	Ventilation, fan intensity level 1-8	1-byte object to output the current fan intensity level.
☐→	111	Ventilation, fan intensity level	1-bit objects to output the current fan intensity level. The number of objects can be parameterized. After a changing the fan intensity level, the waiting time is started at first. The current fan intensity level remains unchanged. The current fan level is deactivated only after the waiting time has elapsed. After deactivation of the old level, the new level is activated.
☐←	119	Ventilation, forced-control	1-bit for activation of a predefined fan intensity level.
☐←	120	Ventilation, level limitation	1-bit object activating the maximum fan level limitation, e.g. during the night.
☐←	121	Ventilation, fan protection	1-bit object which can be used to activate the fan protection.
☐←	122	Outside temperature	2-byte suitable for receiving the measuring value of a separate outside temperature sensor. This value can be displayed and at the same time be used for controlling the setpoint temperature in cooling operation.
☐←	123	Cooling setpoint limiting	1-bit object which can be used for activating the limitation of the maximum setpoint temperature in cooling operation.
☐←	124	Floor temperature	2-byte object which can be used for limiting the intensity of an underfloor heating.
☐←	125	Clock timer channel 1	1-bit object for activating the corresponding symbol on the display.
☐←	126	Clock timer channel 2	1-bit object for activating the corresponding symbol on the display.
☐←	127	Clock timer channel 3	1-bit object for activating the corresponding symbol on the display.

<input type="checkbox"/>	128	Clock timer channel 4	1-bit object for activating the corresponding symbol on the display.
--------------------------	-----	--------------------------	--

Display object description

<input type="checkbox"/>	130	Time of day	3-byte object for receiving the current time of day.
<input type="checkbox"/>	131	Date	3-byte object for receiving the current date.
<input type="checkbox"/>	132	Request date/time of day	1-bit object with which the RCD can request a master clock to transmit the current date and the current time of day. With this information, the RCD can synchronize its internal clock with the master.
<input type="checkbox"/>	133	Backlighting on/off	1-bit object for activating the display backlighting.
<input type="checkbox"/>	133	Backlighting dimmer	1-byte object for adjusting the display backlighting via the bus. The numerical values 0 ... 255 correspond to brightness values of 0% ... 100% (0% = backlighting off)
<input type="checkbox"/>	134	Info-mode:	1-bit object for switching the display info mode on or off. The info mode can be controlled via the second operation level menu or via parameters. The object is hidden if the parameter "Display info after initialization" is set to OFF.
<input type="checkbox"/>	135	Fixed page recall	1-bit object for displaying a parameterized page.
<input type="checkbox"/>	135	Variable page recall	1-byte object for displaying any of the pages.
<input type="checkbox"/>	136	Switching	1-bit objects receiving switching states to be displayed. For the object values 0 and 1, a static text and variable texts can be parameterized.
<input type="checkbox"/>	136 ...138	Value, 1 byte	1-byte objects receiving values to be displayed. Depending on the datapoint type selected, different formatting options (static text, value conversion, unit text) are available
<input type="checkbox"/>	136 ...138	Dimming value	Dimming objects (1 byte) receiving dimming values to be displayed (line display "dimming").
<input type="checkbox"/>	136 ...138	Bind/shutter	1-bit objects receiving the drive control telegrams to be displayed. For the object values 0 and 1, a static text and variable texts can be parameterized.
<input type="checkbox"/>	136 ...138	Light-scene	1-byte objects receiving scene numbers to be displayed. A static text can be parameterized. The scene number is displayed independent of the scene recall or scene storage function.
<input type="checkbox"/>	136 ...138	Value, 2 bytes	2-byte objects receiving values to be displayed. Depending on the datapoint type selected, different formatting options (static text, value conversion, unit text) are available.
<input type="checkbox"/>	136 ...138	Value, 4 bytes	4-byte objects receiving values to be displayed. Depending on the datapoint type selected, different formatting options (static text, value conversion, unit text) are available.
<input type="checkbox"/>	136 ...138	ASCII, 14 bytes	14-byte objects receiving values to be displayed. A static text can be parameterized.
<input type="checkbox"/>	139	Symbol recall page 1	1-bit object or 1-byte object with which a 30 x 30 pixels symbol can be displayed on the right-hand margin of the display window. The 1-byte object is of the "ShowElementNo" datapoint type. This type corresponds to an integer without sign. Possible values of the object: 0: no change 1: show symbol no. 1 2: show symbol no. 2 ... 255: show symbol no. 255 The room controller's memory holds 30 symbols. Any higher value received by the object will be ignored.
<input type="checkbox"/>	152 ... 154	Message Central alarm unit line 1 ... line 3	14-byte objects suitable for receiving texts from a central alarm unit to be displayed. The messages are acknowledged by the following 1-bit object.



155

Central alarm
unit selection1-bit object transmitting an acknowledge message to the central alarm unit
which can then transmit the next text message.

Room controller scope of functions

- Rocker / key functions
 - Each control surface can either be used as a single rocker or as two independent keys.
 - The control surfaces can be configured in such a way that they are arranged in horizontal or vertical direction.
 - Each rocker can be used for the functions 'switching', 'dimming', 'blind/shutter control', '1-byte value transmitter', '2-byte value transmitter' and 'scene extension'.
 - Each key can be used for the functions 'switching', 'dimming', 'blind/shutter control', '1-byte value transmitter', '2-byte value transmitter', 'scene extension' and room temperature controller extension.
 - 2-channel control: Each rocker or each key can be set for controlling two independent channels. This means that only one key-press is enough to transmit up to 2 telegrams to the bus. The channels can be parameterized independent of one another for the functions 'switching', 'value transmitter (1 byte)' or 'temperature value transmitter (2 bytes)' .
 - As far as the rocker functions 'dimming', 'blind/shutter' (operation concept "Long – Short or Short") and '2-channel control' are concerned, a press on the full surface of the rocker can be evaluated as well. With a rocker full-surface actuation it is possible to send switching telegrams and scene recall requests over the bus independently of the programmed rocker function.
 - The switching function offers the following configurations: Reaction on pressing and / or on releasing, switching on, switching off and toggling.
 - The dimming function offers the following configurations: One- or two-surface actuation, times for short and long press, dimming in different steps, telegram repetition on long press, transmission of stop telegram on key release.
 - The blind/shutter control offers the following configurations: One- or two-surface actuation, four different operation concepts with times for short and long press and slat adjustment.
 - The 1-byte and 2-byte value transmitter function offers the following configurations: Selection of the value range (0 ... 100 %, 0 ... 255, 0 ... 65535, 0 ... 1500 lux, 0 ... 40 °C), value on key-press, value variation on sustained key-press with different step widths, times between two value telegrams, behaviour on reaching the limit value.
 - The scene control offers the following configurations: Internal storage of eight scenes with eight output channels, recall of internal scenes by means of a presettable scene number, selection of object types for the output channels; for each scene, the storage of the individual output values and the transmission of the output values can be permitted or inhibited; the individual channels can be delayed during scene recall; as scene extension, 64 scenes can be recalled and stored.
 - The controller extension function offers the following configurations: Operating mode switch-over with normal and high priority, defined selection of an operating mode, change between different operating modes, change of presence status, setpoint shift.
- LED functions
 - Each control surface has two vertically arranged status LEDs.
 - When a status LED is internally connected with the rocker or the key, it can signal a key-press or the current status of a communication object. The status can also be indicated in inverted form.
 - When a status LED is independent of the rocker or key, it can be permanently on or off, indicate the status of its own communication object, the operating state of a room temperature controller or the result of a comparison between signed or unsigned 1-byte values.
 - The operation LED can be permanently on or off, flashing or alternatively switched by means of a communication object.
- Disabling / alarm functions
 - The rockers or keys can be disabled via a 1-bit object. The following configurations are available: Polarity of the disabling object, behaviour at the beginning and at the end of disabling. During an active disable, all or some of the rockers / keys can have no function, can perform the function of a selected key or execute one of two presettable disabling functions.
 - All status LEDs and the operation LED of the room controller can flash simultaneously in case of an alarm message. The following configurations are available: Value of the alarm message object for the states alarm / no alarm, alarm acknowledge by actuation of a key, transmission of the acknowledge signal to other devices.

Room temperature controller scope of functions

- General
 - 5 operating modes: Comfort, standby, night, frost/heat protection and controller disable (dew-point)
 - Operating modes switch-over via 1-byte object according to KONNEX or individual 1-bit objects.
- Heating/cooling system
 - Control options: "heating", "cooling", "heating and cooling" each with or without additional stage.
 - PI control (continuous or switching PWM) or 2-state control (switching) adjustable as control algorithms.
 - Continuous (1-byte) or switching (1-bit) actuating variable output.
 - Control parameter for PI controller (if desired: proportional range, reset time) and 2-state controller (hysteresis) presetable.
 - Fan control manually or as a function of the actuating variable (8 stages max.)
- Setpoint values
 - Each operating mode can have its own temperature setpoints (for heating and/or cooling) assigned.
 - The setpoints for the additional stage are derived via a parameterizable stage offset from the values of the basic stage.
 - Setpoint value shifting by local operation on device itself or via communication objects.
- Functions
 - Automatic or object oriented switch-over between "heating" and "cooling".
 - The controller operation can optionally be disabled via an object.
 - Duration of comfort mode prolongation parameterizable.
 - Complete (1-byte) or partial (1-bit) status information can be parameterized and transmitted to the bus via an object.
 - Deactivation of the control or of the additional stage via different objects possible.
- Room temperature measurement
 - Internal and external room temperature sensor available.
 - Internal to external determination of measured value with enabled external sensor.
 - Request interval of external temperature sensor adjustable.
 - The actual and setpoint temperature can be output to the bus (also cyclically), if a parameterizable deviation is detected .
 - The room temperature measurement (actual value) can be adjusted separately for the internal and external sensor via parameter.
 - Frost/heat protection switch-over depending on window state (delayed detection possible) and automatic frost protection.
 - Temperature alarm with upper and lower temperature limit possible. Telegram activation via two separate objects.
- Actuating variable output
 - Separate or combined actuating variable output via one or two objects for "heating and cooling".
 - Normal or inverted actuating variable output parameterizable
 - Automatic transmission and cycle time for actuating variable output parameterizable
 - Fan control via one 1-byte or eight 1-bit objects.

Display scope of functions

- Backlighting can be dimmed and switched
- Pictograms
 - Operating mode of room temperature controller can be displayed
 - Fan control status display
- Text display
 - Display of four pages max. with up to three lines
 - Page recall cyclical and / or event-triggered
- Info-mode:
 - Display of texts for pushbutton sensor operation
- Second control level
 - Room temperature and fan control settings
 - Display of messages from central alarm unit

Table of contents

1	General settings	30
1.1	Rocker / key selection	31
1.2	Key arrangement	31
1.3	Internal key functions	32
1.4	Operation LED	32
1.5	Transmit delay	33
1.6	Setting of time and date	33
1.7	Language settings	34
2	"Switching" function	35
3	"Dimming" function	35
3.1	Single-surface and double-surface actuation	35
3.2	Advanced parameters	36
3.3	Full-surface actuation	37
4	"Blind/shutter" function	37
4.1	Single-surface and double-surface actuation	37
4.2	Operating concepts	38
4.2.1	Operating concept "step – move – step".	38
4.2.2	Operating concept "move – step"	39
4.2.3	Operating concept "step – move".	39
4.2.4	Operating concept "move – step or step"	40
4.3	Full-surface actuation	40
5	"1-byte value transmitter" and 2-byte value transmitter" function	41
5.1	Value ranges	41
5.2	Variation by means of long key-press	41
5.3	Value variation examples	42
6	Scene extension" function	43
7	2-channel operation	44
7.1	Operating concept channel 1 or channel 2	45
7.2	Operating concept channel 1 and channel 2	46
7.3	Full-surface actuation	46
8	Status LED	47
8.1	Status LED function "always OFF" or "always ON"	48
8.2	Function of the status LED as "actuation indicator / telegram acknowledge"	48
8.3	Function of the status LED as "status indicator"	48
8.4	Function of the status LED as "operating mode indicator (KNX controller)"	48
8.5	Function of the status LED as "controller status indicator"	49
8.6	Function of the status LED as "comparator"	50
9	Scene control	51
9.1	Scene definition and scene recall	51
9.2	Storing scenes	53
10	Disabling of the keys	54
11	Controller extension:	57
11.1	Connection with the room temperature controller	57
11.2	Key functions "Operating mode switch-over" and "Forced operating mode switch-over"	58
11.3	Key function "Presence key"	59
11.4	Key function "Setpoint shift"	59
12	Alarm message	61
13	Room temperature controller functions	62
13.1	Operating modes	65
13.1.1	Operating mode switch-over	66
13.1.2	Notes on the operating modes	72
13.1.3	Controller status	74
13.1.4	Additional controller status	76
13.2	Control options and control option switch-over	77
13.3	Room temperature control and actuating variables	79
13.3.1	Control algorithms, control circuits and calculation of actuating variable	79
13.3.1.1	Adapting the PI control	85
13.3.1.2	Adapting the 2-state control	87
13.3.2	Actuating variable output	88
13.3.2.1	Actuating variable objects	88
13.3.2.2	Automatic transmission	89
13.4	Temperature setpoints	90
13.4.1	Setpoint presettings in the ETS	90
13.4.1.1	Setpoints for the "heating" option	91

<hr/>		
13.4.1.2	Setpoints for the "cooling" option	93
13.4.1.3	Setpoint for the "heating and cooling" option	94
13.4.1.4	Limiting the setpoint temperatures in cooling operation	97
13.4.2	Adjusting the setpoints	97
13.4.2.1	Adjusting basic temperature and setpoint temperatures for comfort, standby and night mode	97
13.4.2.2	Basic setpoint shifting	99
13.4.2.3	Transmitting the setpoint temperature	101
13.5	Room temperature measurement	101
13.5.1	Temperature detection and determination of measured value	102
13.5.2	Calibrating the measured values	103
13.5.3	Transmitting the actual temperature	103
13.6	Disable functions of the room temperature controller	104
13.7	Valve protection	104
13.8	Fan control:	105
13.8.1	Automatic fan control	105
13.8.2	Manual fan control	106
13.8.3	Higher-ranking operating modes	107
14	Display functions	108
14.1	Display elements	108
14.2	Backlighting	109
14.3	Info-mode:	109
14.4	Display pages	109
14.4.1	Page changes:	110
14.4.2	Page layout	110
14.4.3	Display examples	113
14.5	Second operator control level	121
15	Parameters	125
15.1	General parameters	125
15.2	Pushbutton sensor	128
15.3	Room temperature control	169
15.4	Display	181
15.5	Scenes	186

Functional description**1 General settings**

The room controller is equipped with square control surfaces which can be used independently of one another as a rocker with two opposite actuation points or as two keys with one actuation point each. The number of control rockers depends on the room controller variant used.

Depending on the function of the rocker / key, the two red LEDs beside each rocker may be internally connected with the control function. They can, however, also be used for signalling completely independent functions or be permanently on or off.

The blue operation LED can also signal the value of an independent object or be permanently on or off. Besides the functions that can be programmed with the application software, the operation LED also indicates that the room controller is in the programming mode for commissioning or diagnosis purposes. The white illumination of the nameplate can represent the value of an independent 1-bit or 1-byte object (brightness value) or be permanently on or off.

Moreover, the room controller has functions which are not immediately linked with the rockers or keys and which must therefore be additionally enabled by the corresponding parameters. These functions are: controller extension function, room temperature measurement, key functions disable, internal scenes and displaying of alarm messages.

Notes on this product documentation:

On different occasions, the functional description makes use of screenshots of the parameter windows. These screenshots are intended to illustrate the parameter settings described in detail. The pictures were taken with the ETS 3. The representation may vary depending on the type of operating system used and of the pertaining configuration settings.

1.1 Rocker / key selection

The choice between rocker and key control is made on the parameter page "Rocker / key selection". The other parameter pages and the communication objects of the rockers or keys are adapted in line with the settings selected on this tab.

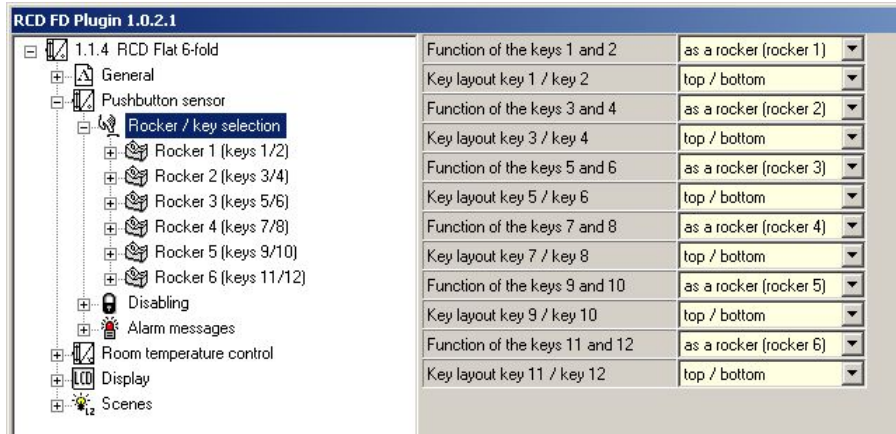

If a control surface is used a rocker, both action points act in common on the communication objects assigned to the rocker. As a rule, a press on the two action points will then produce exactly the opposite reaction (e.g. switching: ON, OFF / blind/shutter: UP - DOWN). The commands given when a key is pressed are generally independent of one another.

Depending on the basic function of a rocker, it is also possible with some settings to use a full-surface actuation with a separate function.

When a control surface is used as separate keys, the keys are parameterized independent of one another and can fulfil completely different functions (e.g. switching: TOGGLE – controller operating mode: comfort). In addition to the function selection in case of the rocker function, the key operation offers moreover the possibility of using the keys as an extension for a room temperature controller. Full-surface actuation of the control surface in the key control mode is not possible.

Pressing several rockers or keys at the same time will be considered as an incorrect operator input. The special rocker function "Full-surface actuation" is an exception to the above rule. In this case, the programming of the rocker decides whether the operation is incorrect or not.

1.2 Key arrangement

With the "Key arrangement" parameter, the user can select separately for each key pair of a control surface how the keys are to be arranged on the surface, i.e. where the actuation points are located.

In the basic configuration the two actuation points of a control surface are arranged vertically (top / bottom). As an alternative, the actuation points can be arranged horizontally (left / right).

Different key arrangements can also be programmed in a room controller. The key configuration can still be changed later on. Assigned group addresses or parameter settings remain unaffected.

1.3 Internal key functions

The keys of the room controller can be used on the one hand for sending telegrams to other devices and on the other hand for executing internal functions. These internal functions do not result directly in a transmission of telegrams.

The following internal functions are available:

- Fan control: A key to which the "Fan control" function has been assigned acts immediately on the fan control as part of the room temperature control. A second parameter determines whether the fan control will be switched on the press of a key into automatic or into manual operation. The length of the key-press is not relevant. The function of the fan control is discussed in detail in the room temperature control description.
- Info-key: The info mode can be used to display help on the use of a key when this key is pressed. The use of the info mode is described under the display functions.
- Page changing: The display can show up to four pages with up to three lines per page. A key for changing the page can either be used for calling up a specific page directly or for calling up different pages in a defined order. The use of this feature is described under the display functions.
- Operating mode switch-over: Switching over of the operating mode has an immediate effect on the internal room temperature controller. The functions are discussed in the room temperature controller description.
- Setpoint shifting: Shifting of the setpoint has an immediate effect on the internal room temperature controller. Each press of a key increments or decrements the room temperature by a step. The setpoint shifting functions and the steps are discussed in the room temperature controller description.

1.4 Operation LED

The blue operation LED of the room controller is used for different functions which are partly fixed internal default functions.

- In a non-programmed device (as-supplied state) or after downloading of a wrong application program, this LED flashes at a slow rate of 0.75 Hz.
- When the room controller is switched over into the programming mode for commissioning or for ETS diagnosis purposes, the LED flashes at a fast rate of about 8 Hz (cf. "Commissioning" in the hardware description of this documentation).
- To confirm the detection of a full-surface press with the rocker function, the LED flashes with 8 Hz, too.

More LED functions can be preset by means of the parameters in the application software:

- The LED can be programmed to flash together with all other red status LEDs with a frequency of about 2 Hz, when the communication object for the alarm message is active.
- The LED can display the status of a separate communication object in inverted or non-inverted form.
- The LED can be switched on permanently to serve as an orientation light.
- The LED can be permanently off.

If several of the above states occur at the same time, the priority is as follows:

1. Display of the programming mode. The programming mode is cancelled automatically after a key-press.
2. Display of a valid full-surface actuation with the rocker function.
3. Display of an alarm. The mode of resetting the alarm either automatically by a key-press or by the communication object must be specified in the parameters.
4. The status display of the separate communication object or the permanent states (on, off).

1.5 Transmit delay

After a reset (e.g. after loading of an application program or the physical address or after return of bus voltage), the room controller can automatically transmit telegrams for the room temperature controller extension and room temperature measurement functions. In case of the controller extension, the room controller attempts to get values from the room temperature controller by means of read telegrams in order to update the object states. In case of the room temperature measurement, the room controller transmits the current room temperature to the bus after a reset.

If there are still other devices in the bus which transmit telegrams immediately after a reset, it may be useful to activate the transmit delay for automatically transmitting objects on the "General" parameter page in order to reduce the bus load.

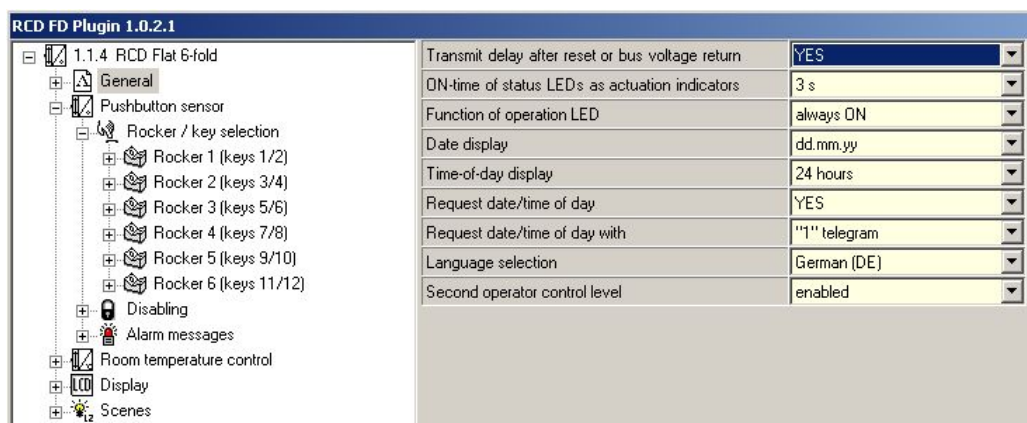

If the transmit delay is activated, the room controller infers the value of its individual delay from the device number in its physical address (physical address: area, line, device number). This value can be about 30 seconds maximum. Without setting a special delay, this principle prevents several room controllers from transmitting telegrams to the bus at the same time.

The transmit delay is not active for the rocker and key functions of the room controller.

1.6 Setting of time and date

The room controller can also display the current time of day and the current date. The internal computation of the current time of day is influenced to a large extent by the size of the internal functions and the data traffic caused thereby. This may result in quite significant deviations. For this reason, the internal time and the internal date should be synchronized at regular intervals. Thus, it is recommended to have a master clock with DCF 77 receiver transmit the current time of day once every hour and the current date once a day to the bus.

Depending on the "Date / time request" parameter, the communication object "Request date / time of day" can transmit a value of "1" for the date at 00:00 and for the time of day at 04:00 to a master clock to request the latest data for synchronization purposes.

The room controller checks whether a synchronization has occurred within the last 24 hours. If this is not the case, the controller displays --:-- instead of the time and --.--- instead of the date.

The time of day can either be displayed in the 12-hour format or in the 24-hour format. This setting is valid for all display screens. The 12-hour format is displayed without additional a.m. and p.m. information.

The date can be displayed in different formats to account for country-specific display standards. The default display is day.month.year. The screen pages can display the year partly with two digits and partly with four digits. The format depends on the space requirements of the character sets used.

1.7 Language settings

The language for the display of text in the info mode and on the second control level can be selected on parameter page "General".

The screenshot shows the configuration interface for the RCD FD Plugin 1.0.2.1. On the left, a tree view shows the configuration structure under '1.1.4 RCD Flat 6-fold', with 'General' selected. On the right, a list of parameters is displayed with their current values:

Transmit delay after reset or bus voltage return	YES
ON-time of status LEDs as actuation indicators	3 s
Function of operation LED	always ON
Date display	dd.mm.yy
Time-of-day display	24 hours
Request date/time of day	YES
Request date/time of day with	"1" telegram
Language selection	German (DE)
Second operator control level	enabled

2 "Switching" function

For each rocker or each key with the function set to "switching" the ETS indicates a 1-bit communication object. The parameters of the rocker or key permit fixing the value this object is to adopt on pressing and / or on releasing of the key (ON, OFF, TOGGLE - toggling of the object value). No distinction is made between a brief or long press.

The status LEDs can be parameterized independently as described in chapter "8. Status LED".

3 "Dimming" function

For each rocker or each key with the function set to "dimming" the ETS indicates a 1-bit and a 4-bit object. Generally, the room controller sends a switching telegram after a brief press and a dimming telegram after a long press. In the standard parameterization, the room controller transmits a telegram for stopping the dimming action after a long press. The time needed by the room controller to identify an actuation as a long actuation is presettable in the parameters.

The status LEDs can be parameterized independently as described in chapter "8. Status LED".

3.1 Single-surface and double-surface actuation

A rocker is preprogrammed for double-surface actuation. This means that the room controller transmits a telegram for switching on after a brief press and a telegram for increasing the brightness after a long press on the upper action point. Similarly, the room controller transmits a telegram for switching off after a brief press and a telegram for reducing the brightness after a long press on the lower action point.

Separate keys are preprogrammed for single-surface actuation. In this mode, the room controller transmits on each brief press alternating ON and OFF telegrams ("TOGGLE") . After a long press, the room controller transmits alternating "brighter" and "darker" telegrams.

For the rocker and also for the key function, the command issued on pressing the key or rocker can basically be selected at the user's discretion.

If the actuator can be controlled from several sensors, a faultless single-surface actuation requires that the addressed actuator reports its switching state back to the 1-bit object of the key or rocker and that the 4-bit objects of the room controllers sensors are linked with one another. The room controller would otherwise not be able to recognize that the actuator has been addressed from another sensor, in which case it would have to be actuated twice during the next use in order to produce the desired reaction.

3.2 Advanced parameters

For the dimming function, the room controller can be programmed with advanced parameters which are hidden in the standard view for greater clarity. If necessary, these advanced parameters can be activated and thus be made visible.

The advanced parameters can be used to determine whether the room controller is to cover the full adjusting range of the actuator continuously with one dimming telegram ("Increase brightness by 100 %", "Reduce brightness by 100 %") or whether the dimming process is to be performed in several small steps (50 %, 25 %, 12,5 %, 6 %, 3 %, 1,5 %).

In the continuous dimming mode (100%), the room controller transmits a telegram only at the beginning of the long press to start the dimming process and generally a stop telegram after the end of the press. For dimming in small steps it may be useful if the room controller repeats the dimming telegram in case of a sustained press automatically at presettable intervals (parameter "Telegram repetition"). The stop telegram after the end of the press is then not needed.

When the parameters are hidden ("Advanced parameters = deactivated"), the dimming range is set to 100 %, the stop telegram is activated and the telegram repetition is deactivated.

3.3 Full-surface actuation

When a rocker is used for dimming, the room controller needs a certain time at the beginning of each actuation in order to distinguish between a short and a long actuation. When the full-surface actuation is enabled, the room controller can make use of this time span to evaluate the otherwise invalid simultaneous actuation of both action points.

The room controller detects a full-surface actuation of a rocker, if a control surface is depressed in such a way that both action points of the rocker are actuated at the same time.

When the room controller has detected a valid full-surface actuation, the operation LED flashes fast at a rate of about 8 Hz for the duration of such actuation. The full-surface actuation must have been detected before the first telegram has been transmitted by the dimming function (switching or dimming). If this is not so, even a full-surface actuation will be interpreted as an incorrect operation and not executed.

A full-surface actuation is independent. It has a communication object of its own and can optionally be used for switching (ON, OFF, TOGGLE – toggling of the object value) or for a scene recall without or with storage function. In the latter case, the full-surface actuation causes a scene to be recalled in less than a second. If the room controller is to send the telegram for storing a scene, the full-surface actuation must be maintained for more than 5 seconds. If the full-surface actuation ends between the first and the fifth second, the room controller will not send any telegrams.

If the status LEDs of the rocker are used as "actuation indicators", they will light up for 3 seconds during transmission of the storage telegram.

4 "Blind/shutter" function

For each rocker or each key with the function set to "blind/shutter" the ETS indicates the two 1-bit objects "short-time operation" and "long-time operation".

The status LEDs can be parameterized independently as described in chapter "8. Status LED".

4.1 Single-surface and double-surface actuation

A rocker is preprogrammed for double-surface actuation. This means that the room controller transmits a telegram for an upward movement after an actuation of the upper action point and a telegram for a downward movement after an actuation of the lower action point.

Separate keys are preprogrammed for single-surface actuation. In this case, the room controller changes the direction of the long-time telegram (TOGGLE) after each sustained press. Several short-time telegrams in succession have the same direction.

For the key function, the command issued on pressing the key can basically be selected at the user's discretion.

If the actuator can be controlled from several sensors, a faultless single-surface actuation requires that the long-time objects of the room controllers are interlinked. The room controller would otherwise not be able to detect that the actuator has been addressed from another sensor, in which case it would have to be actuated twice during the next use in order to produce the desired reaction.

4.2 Operating concepts

For the control of blind, shutter, awning or similar drives, the room controller supports four operating concepts in which telegrams with a different timing are transmitted. The room controller can therefore be used to operate various drive configurations.

The different operating concepts are described in detail in the following chapters.

4.2.1 Operating concept "step – move – step".

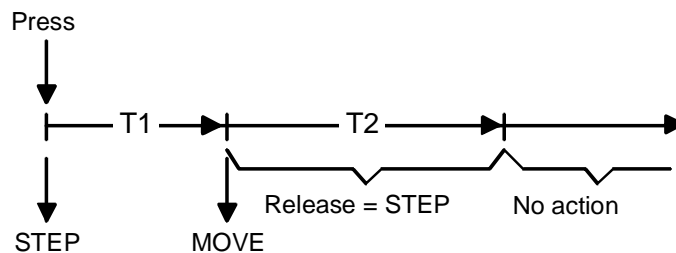

In the operating concept "step – move – step", the pushbutton sensor shows the following behaviour:

- Immediately on pressing the key, the room controller transmits a short-time telegram. This key-press stops a running drive and starts time T1 ("time between short- and long-time command") If the key is released within T1, no further telegram will be transmitted. This step serves the purpose of stopping a continuous movement.
The "time between short- and long-time command" in the room controller should be selected shorter than the short-time operation of the actuator to prevent undesired jerky movements of the shutter.
- If the key is kept depressed longer than T1, the room controller transmits a long-time telegram after the end of T1 for starting up the drive motor and time T2 ("slat adjustment time") is started.
- If the key is released within the slat adjustment time, the room controller sends another short-time telegram. This function is used for adjusting the slats of a blind. The function permits stopping the slats in any position during their rotation.
The "slat adjustment time" should be chosen as required by the drive for a complete rotation of the slats. If the slat adjustment time is selected longer than the complete running time of the drive, a pushbutton function is possible as well. This means that the drive is active only when the key is kept depressed.
- If the key is kept depressed longer than T2, the room controller transmits no further telegrams. The drive remains on until the end position is reached.

4.2.2 Operating concept "move – step"

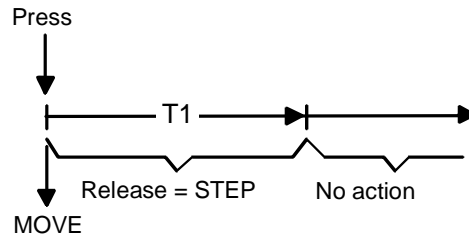

If the operating concept "move – step" is selected, the room controller shows the following behaviour:

- Immediately on pressing the key, the room controller transmits a long-time telegram. The drive begins to move and time T1 ("slat adjustment time") is started.
- If the key is released within the slat adjustment time, the room controller sends a short-time telegram. This function is used for adjusting the slats of a blind. The function permits stopping the slats in any position during their rotation. The "slat adjustment time" should be chosen as required by the drive for a complete rotation of the slats. If the slat adjustment time is selected longer than the complete running time of the drive, a pushbutton function is possible as well. This means that the drive is active only when the key is kept depressed.
- If the key is kept depressed longer than T1, the room controller transmits no further telegrams. The drive remains on until the end position is reached.

4.2.3 Operating concept "step – move".

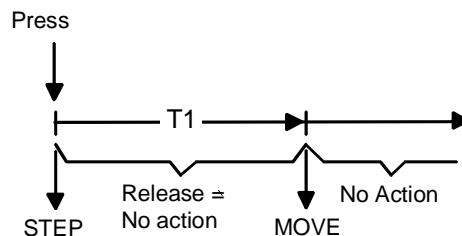

In the operating concept "step – move", the room controller shows the following behaviour:

- Immediately on pressing the key, the room controller transmits a short-time telegram. This key-press stops a running drive and starts time T1 ("time between short- and long-time command") If the key is released within T1, no further telegram will be transmitted. This step serves the purpose of stopping a continuous movement. The "time between short- and long-time command" in the room controller should be selected shorter than the short-time operation of the actuator to prevent undesired jerky movements of the shutter.
- If the key is kept depressed longer than T1, the room controller transmits a long-time telegram after the end of T1 for starting the drive.
- No further telegram is transmitted when the key is released. The drive remains on until the end position is reached.

4.2.4 Operating concept "move – step or step"

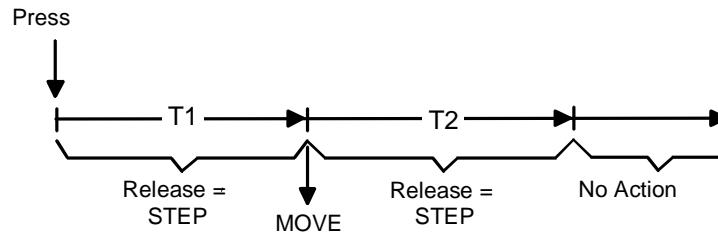

In the operating concept "move – step or step", the room controller shows the following behaviour:

- Immediately on pressing the key, the room controller starts time T1 ("time between short- and long-time command") and waits. If the key is released again before T1 has elapsed, the room controller transmits a short-time telegram. This telegram can be used to stop a running drive. A stationary drive rotates the slats by one step.
- If the key is kept depressed after T1 has elapsed, the room controller transmits a long-time telegram and starts time T2 ("slat adjustment time").
- If the key is released within time T2, the room controller sends another short-time telegram. This function is used for adjusting the slats of a blind. The function permits stopping the slats in any position during their rotation.
The "slat adjustment time" should be chosen as required by the drive for a complete rotation of the slats. If the slat adjustment time is selected longer than the complete running time of the drive, a pushbutton function is possible as well. This means that the drive is active only when the key is kept depressed.
- If the key is kept depressed longer than T2, the room controller transmits no further telegrams. The drive remains on until the end position is reached.

In this operating concept, the room controller will not transmit a telegram immediately after depressing one side of the rocker. This principle permits detecting a full-surface actuation when the sensor is configured as a rocker.

4.3 Full-surface actuation

When a rocker is programmed for blind/shutter operation and if the operating concept "move – step or step" is used, the room controller needs some time at the beginning of each actuation in order to distinguish between a short and a long actuation. When full-surface actuation is enabled, the room controller can make use of this time span to evaluate the otherwise invalid simultaneous actuation of both action points.

The room controller detects a full-surface actuation of a rocker, if a control surface is depressed in such a way that both action points of the rocker are actuated at the same time.

When the room controller has detected a valid full-surface actuation, the operation LED flashes fast at a rate of about 8 Hz for the duration of such actuation. The full-surface actuation must have been detected before the first telegram has been transmitted by the blind/shutter function (STEP or MOVE). If this is not so, even a full-surface actuation will be interpreted as an incorrect operation and not executed.

A full-surface actuation is independent. It has a communication object of its own and can optionally be used for switching (ON, OFF, TOGGLE – toggling of the object value) or for a scene recall without or with storage function. In the latter case, the full-surface actuation causes a scene to be recalled in less than a second. If the room controller is to send the telegram for storing a scene, the full-surface actuation must be maintained for more than 5 seconds. If the full-surface actuation ends between the first and the fifth second, the room controller will not send any telegrams. If the status LEDs of the rocker are used as "actuation indicators", they will light up for 3 seconds during transmission of the storage telegram.

5 "1-byte value transmitter" and 2-byte value transmitter" function

For each rocker or each key with the function set to "1-byte value transmitter" or "2-byte value transmitter" the ETS indicates a corresponding object.

On the press of a key, the parameterized value or the value last stored internally by a value change (see below) will be transmitted to the bus. In case of a rocker function, different values can be parameterized or varied for both action points.

The status LEDs can be parameterized independently as described in chapter "8. Status LED".

5.1 Value ranges

The "Functionality" parameter determines the value range used by the controller.

As a 1-byte value transmitter, the room controller can optionally transmit integers from 0 ... 255 or relative values within a range of 0 ... 100 % (e.g. as dimming value transmitter).

As a 2-byte value transmitter, the room controller can optionally transmit integers from 0 ... 65535, temperature values within a range of 0 ... 40 °C or brightness values from 0 ... 1500 lux.

For each of these ranges, the value that can be transmitted to the bus for each actuation of a rocker or key is parameterizable.

5.2 Variation by means of long key-press

If the value variation feature has been enabled in the ETS, the key must be kept depressed for more than 5 seconds in order to vary the current value of the value transmitter. The value variation function continues to be active until the key is released again. In a value variation, the room controller distinguishes the following options...

- The "Starting value for value variation" parameter defines the original starting value for the variation. Variation can begin from the value parameterized in the ETS, from the final value of the last variation cycle or from the current value of the communication object, with the last option not being available for the temperature and brightness value transmitter.
- The parameter "Direction of value variation" defines whether the values will always be increased ("upwards"), always reduced ("downwards") or alternately increased and reduced ("switch-over").
- For the value transmitters 0 ... 255, 0 ... 100 % and 0 ... 65535, the step size by which the current value is to be changed during the value variation can be specified. In case of the temperature and the brightness value transmitter, the step sizes (1 °C and 50 lux) are fixed.
- The parameter "Time between two telegrams" can be used in conjunction with the step size to define the time required to cycle through the full respective value range. This value defines the time span between two value transmissions.
- When the room controller detects during the value variation that the preset step size would result in the limits being exceeded with the next telegram, it adapts the step size once in such a way that the respective limit value is transmitted together with last telegram. Depending on the setting of the parameter "Value variation with overflow", the room controller stops the variation at this instance or inserts a pause consisting of two steps and then continues the variation beginning with the other limit value.

Value range limits for the different value transmitters:

	Functionality	Lower end of number range	Upper end of number range
Value transmitter 1-byte	0 ... 255	0	255
	0 ... 100 %	0 % (value = "0")	100 % (value = "255")
Value transmitter 2-byte	0 ... 65535	0	65535
	Temperature value	0 °C	40 °C
	Brightness value	0 lux	1500 lux

Notes on value variation:

- During a value variation, the newly adjusted values are stored only in the volatile RAM memory of the room controller. Therefore, the stored values are replaced by the preset values programmed in the ETS when the room controller is reset (bus voltage failure or ETS programming).
- During a value variation, the status LED of the corresponding key is switched off irrespective of its parameterization. The status LED will then light up for ca. 250 ms whenever a new value is transmitted.
- When the 1-byte value transmitter operates in the "Value transmitter 0...100 %" function, the step size of the variation is also indicated in "%". If the starting value of the communication object is used, it may happen in this case during value variation that the value last received via the object must be rounded and adapted before a new value can be calculated on the basis of the step size and transmitted. Due to the computation procedure used, the new calculation of the value may be slightly inaccurate.

5.3 Value variation examples

Parameterization:

- Value transmitter 1 byte (all other value transmitters basically identical)
- functionality = value transmitter 0...255
- value specified in the ETS (0...255) = 227
- step width (1...10... 5)
- start on value variation = like parameterized value
- direction of value variation = switch-over (alternating)
- time between two telegrams = 0.5 s

Example 1: value variation with overflow? = No

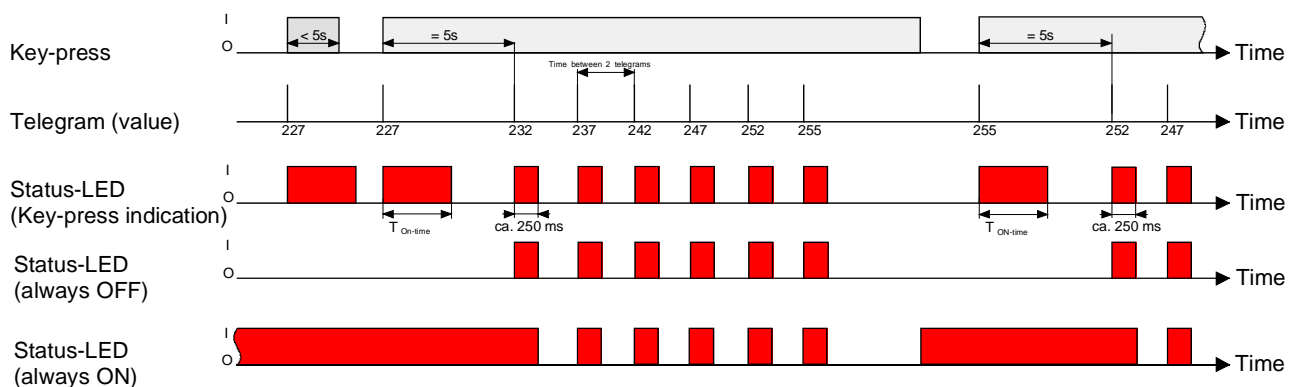

Example 2: value variation with overflow? Yes

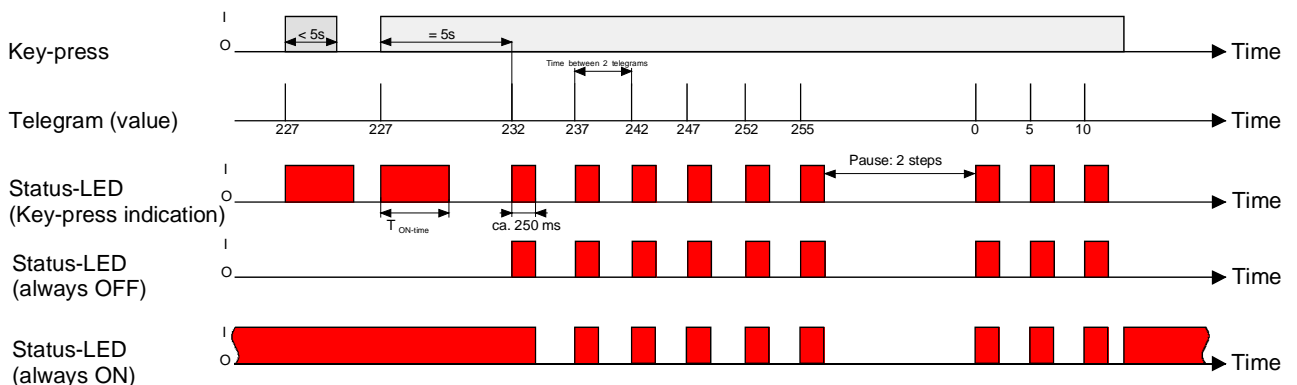

6 Scene extension" function

For each rocker or each key with the function set to "scene extension" the ETS indicates the "Function" parameter which distinguishes between ...

- "Scene extension without storage function"
- "Scene extension with storage function"
- "Internal scene recall without storage function"
- "Internal scene recall with storage function"

In the scene extension function, the room controller transmits a preset scene number (1..64) via a separate communication object to the bus when a key is pressed. This feature permits recalling scenes stored in other devices and also storing them, if the storage function is used.

The recall of an internal scene does not result in a telegram being transmitted on the bus. For this reason, the corresponding communication object is not existing. This function can rather be used to recall – and with the storage function also to store – the 8 scenes max. stored internally in the room controller.

In the setting "... without storage function", a key-press triggers the simple recall of a scene. If the status LED is parameterized as actuation indicator, it will be switched on for the parameterized ON-time. A long key-press has no further or additional effect.

In the setting "... with storage function", the room controller monitors the length of the actuation. A key-press of less than a second results in a simple recall of the scene as mentioned above. If the status LED is parameterized as actuation indicator, it will be switched on for the parameterized ON-time.

After a key-press of more than five seconds, the room controller generates a storage instruction. In the scene extension function, a storage telegram is in this case transmitted to the bus. If configured for the recall of an internal scene, the sensor will store the internal scene. The internal scene control module of the room controller will then request the current scene values for the actuator groups used from the bus (cf. chapter "9 Scene control").

An actuation lasting between one and five seconds will be discarded as invalid.

The parameter "Scene number" specifies which of the maximum of 8 internal or 64 external scenes is to be used after a key-press. In case of the rocker function, two different scene numbers can be assigned.

The status LEDs can be parameterized independently as described in chapter "8. Status LED".

7 2-channel operation

In some situations it is desirable to control two different functions with a single key-press and to transmit different telegrams, i.e. to operate two function channels at a time. This is possible with the "2-channel operation" function.

For both channels, the parameters "Function channel 1" and "Function channel 2" can be used to determine the communication object types to be used. The following types are available...

- Switching (1 bit)
- Value transmitter 0 ... 255 (1 byte)
- Value transmitter 0 ... 100 % (1 byte)
- Temperature value transmitter (2 bytes)

The object value the room controller is to transmit on a key-press can be selected depending on the selected object type. The "Switching (1 bit)" type permits selecting whether an ON or an OFF telegram is to be transmitted or whether the object value is to be switched over (TOGGLE) and transmitted on the press of a key. The parameterization as "Value transmitter 0 ... 255 (1 byte)" or as "Value transmitter 0 ... 100 % (1 byte)" permits entering the object value freely within a range from 0 to 255 or from 0% to 100%.

A temperature value between 0°C and 40°C can be selected as "Temperature value transmitter (2 bytes)".

In this case, the variation of the object value on a long key-press is not possible as the determination of the actuation length is needed for the adjustable operating concepts.

Unlike in the other rocker and key functions, the application software assigns the "Telegram acknowledge" function instead of the "Actuation indicator" function to the status LED. In this mode, the status LED lights up for about 250 ms with each telegram transmitted. As an alternative, the status LEDs can be parameterized independently as described in chapter "8. Status LED".

7.1 Operating concept channel 1 or channel 2

In this operating concept, exactly one telegram will be transmitted on each press of a key.

- A short press causes the room controller to transmit the telegram for channel 1.
- A long press causes the room controller to transmit the telegram for channel 2.

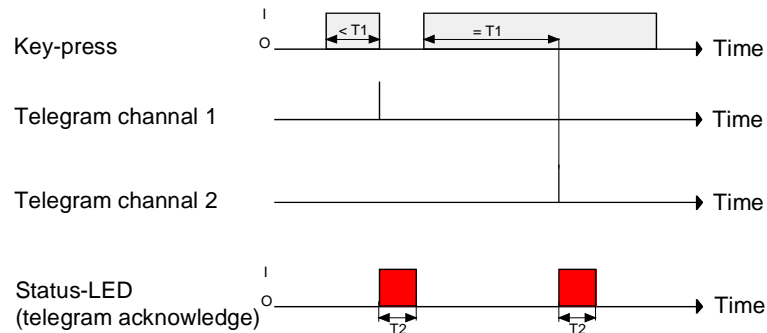

T_1 = time between channel 1 and 2
 T_2 = on-time for telegram acknowledge (approx. 250 ms)

The time required for distinguishing between a short and a long actuation is defined by the parameter "Time between channel 1 and channel 2". If the key is pressed for less than the parameterized time, only the telegram to channel 1 is transmitted. If the length of the key-press exceeds the time between channel 1 and channel 2, only the telegram to channel 2 will be transmitted. This concept provides the transmission of only one channel. To indicate that a telegram has been transmitted, the status LED lights up for ca. 250 ms in the "Telegram acknowledge" mode.

In this operating concept, the room controller will not transmit a telegram immediately after depressing the rocker. This principle permits detecting also a full-surface actuation. The settings that are possible with full-surface actuation are described below

7.2 Operating concept channel 1 and channel 2

In this concept, one or alternatively two telegrams can be transmitted for each press.

- A short press causes the room controller to transmit the telegram for channel 1.
- A long press causes the room controller to transmit first the telegram for channel 1 and then the telegram for channel 2.

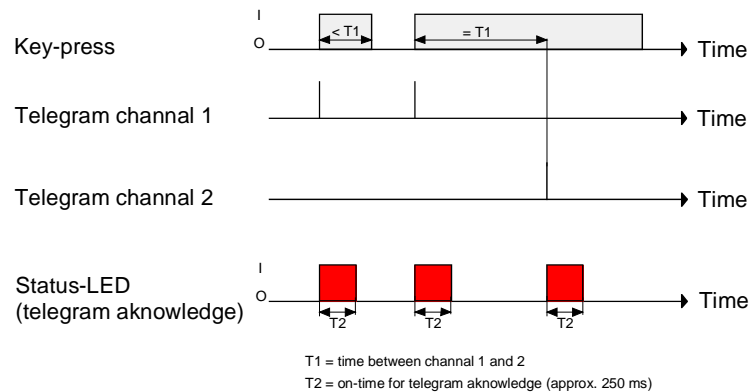

The time required for distinguishing between a short and a long actuation is defined by the parameter "Time between channel 1 and channel 2". In this operating concept, a key-press sends this telegram immediately to channel 1. If the key is held depressed for the parameterized time, the telegram for the second channel will be transmitted as well. If the key is released before the time has elapsed, no further telegram will be transmitted. This operating concept, too, offers the parameterizable possibility of having the transmission of a telegram signalled by the status LED (setting "Telegram acknowledge").

7.3 Full-surface actuation

When a rocker is programmed for 2-channel operation and if the operating concept "channel 1 or channel 2" is used, the room controller needs some time at the beginning of each actuation in order to distinguish between a short and a long actuation. When the full-surface actuation is enabled, the room controller can make use of this time span to evaluate the otherwise invalid simultaneous actuation of both action points.

The room controller detects a full-surface actuation of a rocker, if a control surface is depressed in such a way that both action points of the rocker are actuated at the same time.

When the room controller has detected a valid full-surface actuation, the operation LED flashes fast at a rate of about 8 Hz for the duration of such actuation. The full-surface actuation must have been detected before the first telegram has been transmitted by the 2-channel function. If this is not so, even a full-surface actuation will be interpreted as an incorrect operation and not executed.

A full-surface actuation is independent. It has a communication object of its own and can optionally be used for switching (ON, OFF, TOGGLE – toggling of the object value) or for a scene recall without or with storage function. In the latter case, the full-surface actuation causes a scene to be recalled in less than a second. If the room controller is to send the telegram for storing a scene, the full-surface actuation must be maintained for more than 5 seconds. If the full-surface actuation ends between the first and the fifth second, the room controller will not send any telegrams. If the status LEDs of the rocker are used as "actuation indicators", they will light up for 3 seconds during transmission of the storage telegram.

8 Status LED

Each rocker has two status LEDs and each key has one status LED. Depending on the configuration of the rockers or keys, the available functions differ slightly.

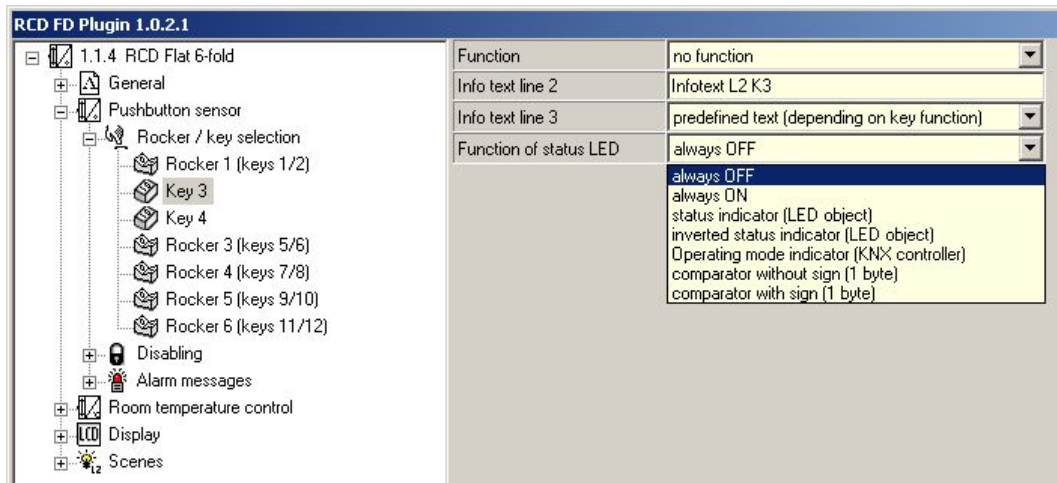

Each status LED can indicate the following options...

- always OFF,
- always ON,
- status display (LED object),
- inverted status display (LED object),
- operating mode indication (KNX controller),
- controller status indication (activate controller extension!),
- comparator without sign (1 byte),
- comparator with sign (1 byte).

These are always available even the rocker or key has no function assigned to it.

If a function is assigned to the rocker or to the key, the ETS additionally provides the option...

- Key-press indication,
which is replaced for the "2-channel operation" function by...
- telegram acknowledge.

If the rocker or the key is used for switching and dimming, the following options are available in addition...

- Status indication (switching object),
- Inverted status indication (switching object)

If a key is used for controller extension operation, the following options can be preset in addition...

- Key function indication active / inactive (only with presence key),
- setpoint shift indication (only with setpoint shift)

Besides the functions that can be preset separately for each status LED, all status LEDs are also used together with the operation LED for alarm messages. In case of an active alarm message, all LEDs of the room controller flash at the same time. After deactivation of the alarm message, all LEDs will immediately return to the state corresponding to their parameterization and communication objects.

8.1 Status LED function "always OFF" or "always ON"

The two status LED functions "always OFF" and "always ON" have no further settings and no communication objects. In this setting, the status LED is either permanently ON or permanently OFF.

8.2 Function of the status LED as "actuation indicator / telegram acknowledge"

A status LED used as actuation indicator is switched on by the room controller each time the corresponding rocker or key is pressed. The "ON-time of the status LED as actuation indicator" parameter on parameter page "General" defines how long the LED is lit up. The status LED lights up when the rocker or key is pressed even if a telegram is transmitted by the room controller only after the key or rocker has been released.

In the "2-channel operation" function, the "actuation indicator" option is replaced by the "telegram acknowledge" option. In this case, the status LED lights up for about 250 ms during transmission of the telegrams for both channels.

8.3 Function of the status LED as "status indicator"

Each status LED can indicate the status of a separate LED communication object independent of the rocker or key configuration. Additionally, the status LEDs can be linked in the rocker or key functions "switching" and "dimming" also with the object used for switching and thus signal the current switching state of the actuator group.

For both, the status indication of the LED object and the status indication of the switching object, the inverted value can be indicated as well.

After a reset of the room controller or after an ETS programming operation, the value of the LED object is always "OFF - 0".

8.4 Function of the status LED as "operating mode indicator (KNX controller)"

For switching over between different operating modes, new room temperature controllers can make use of two communication objects of the 20.102 "HVAC-Mode" data type. One of these objects can switch over with normal priority between the operating modes "comfort", "standby", "night", "frost/heat protection". The second object has a higher priority. It permits switching over between "automatic", "comfort", "standby", "night", "frost/heat protection". Automatic means in this case that the object with the lower priority is active.

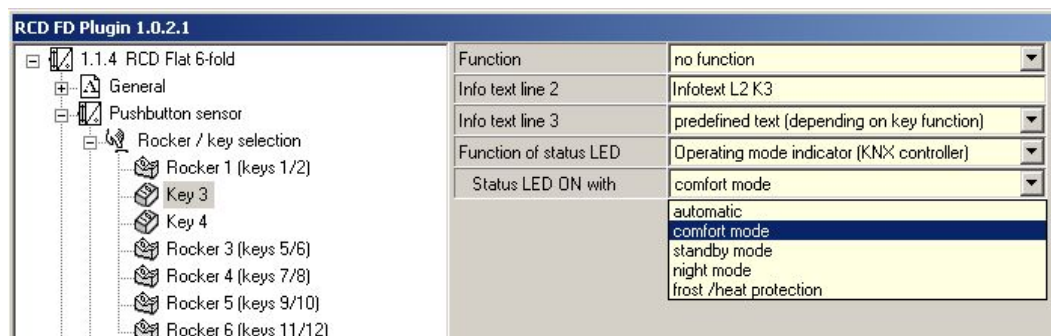

If a status LED is to indicate the operating mode, the communication object of the status LED must be linked with the matching object of the room temperature controller. The desired mode which the LED is to indicate can then be selected with the parameter "Status LED on with..." The LED is then lit up when the corresponding operating mode has been activated in the controller.

After a reset of the room controller or after an ETS programming operation, the value of the LED object is always "0" (automatic).

8.5 Function of the status LED as "controller status indicator"









If a status LED is to indicate the status of a room temperature controller, the controller extension must have been activated on parameter page "General". The status LED is then internally linked directly with the 1-byte object "Controller status" of the controller extension. This object must then be linked via a group address with the corresponding communication object of the controller.

The object "Controller status" groups eight different information units in a bit-oriented way in a byte. For this reason, it is important to select in the "Status LED on with..." parameter which information is to be indicated, i.e. which bit is to be evaluated.

The following bits can be selected...

- Bit 0: comfort operation
- Bit 1: standby operation
- Bit 2: night-time operation
- Bit 3: frost/heat protection
- Bit 4: controller disabled
- Bit 5: heating / cooling (heating = 1 / cooling = 0)
- Bit 6: controller inactive (dead-zone operation)
- Bit 7: frost alarm

Description of bit-oriented status messages of the room temperature controller (active = ON):

- Comfort operation:
active if operating mode "comfort"  or "comfort prolongation"   or   is activated.
- Standby operation:
active if the operating mode "standby"  is activated.
- Night-time operation:
active if the operating mode "night"  is activated.
- Frost/ heat protection:
active if the operating mode "frost/heat protection"  is activated.
- Controller disabled:
active if controller disable is activated (dew-point mode).
- Heating/cooling:
active if the heating mode is activated and inactive if the cooling mode is activated. (as a rule inactive when the controller is disabled.)
- Controller inactive:
active with the "*heating and cooling*" control option when the measured room temperature lies within the dead zone. This status information is generally "0" for the individual "*heating*" or "*cooling*" options! (inactive if controller is disabled.)
- Frost alarm:
active if the detected room temperature reaches or drops below + 5 °C.

The communication object "Controller status" of the controller extension is updated automatically after a reset of the room controller or after an ETS programming operation, if the parameter "Value request value by controller extension" on parameter page "General" is set to "yes". Updating is effected by means of a value read telegram to the room temperature controller. The controller must answer the request with a value feedback telegram. If the room controller does not receive the answer, the status LED remains off (object value "0"). In this case, the object must first be reactivated via the bus after a reset before a status information can be indicated by the LED. This is also the case, if the "Request value from controller extension" parameter is set to "no".

8.6 Function of the status LED as "comparator"

The status LED can indicate whether a parameterized comparison value is greater than, equal to or less than the 1-byte object value of the status object. This comparator can be used for unsigned (0 ... 255) or for signed (-128 ... 127) integers. The data format of the comparison is defined by the function of the status LED. The status LED lights up only if the comparison is "true".

After a reset of the room controller or after an ETS programming operation, the value of the LED object is always "0".

9 Scene control

The room controller can be used in two different ways in a scene control...

- Each rocker or key can work as a scene extension. This feature makes it possible to recall or to store scenes which may be stored in other devices.
- The room controller can independently store up to eight scenes with eight actuator groups. These internal scenes can be recalled or stored by the rockers or keys (internal scene recall) and also by the communication object "scene extension".
In the following subsections the internal scene function will be dealt with in greater detail.

9.1 Scene definition and scene recall

If the internal scenes are to be used, the parameter "scene function" on parameter page "Scenes" must be set to "yes".

The matching data types for the eight scene outputs must then be selected and adapted to the actuator groups used. The types "Switching", "Value (0 ... 255)" or "Value / shutter position (0 ... 100 %)" can be selected. As a rule, blinds are controlled via two scene outputs. One output controls the height of the curtain and the other one adjusts the slat position.

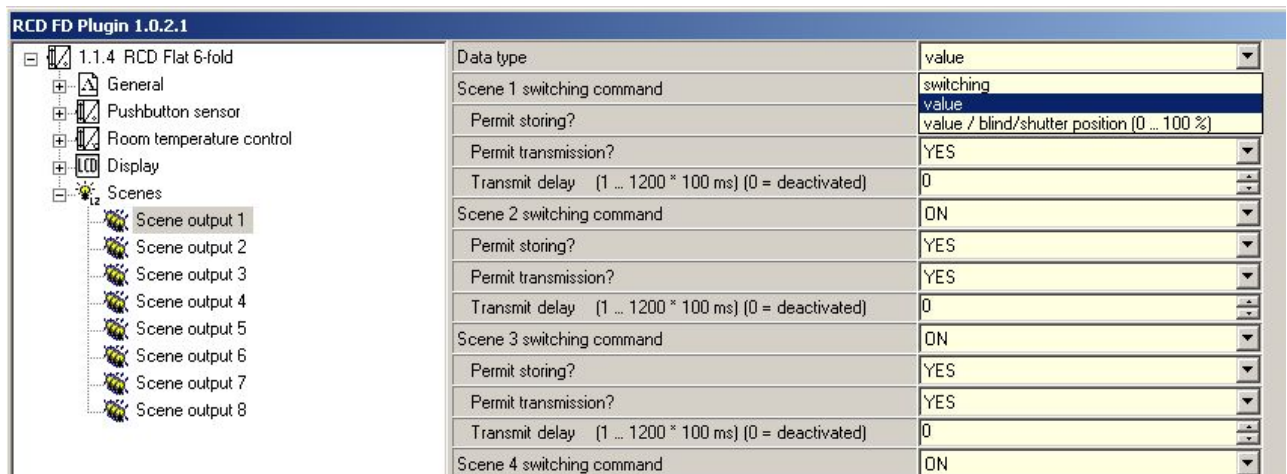

The ETS displays the communication objects and the scene control parameters pertaining to these data-types

It is possible that the values for the individual scenes preset by the parameters are modified later on with the storage function (cf. chapter "9.2 Storage function") when the system is in operation. If the application program is then downloaded again with the ETS, these locally adapted values will be overwritten by the parameters. Due to the fact that it may take considerable efforts to readjust the values for all scenes in the system, the parameter "Overwrite scene values during ETS download ?" offers the possibility of retaining the scene values stored in operation without overwriting them.

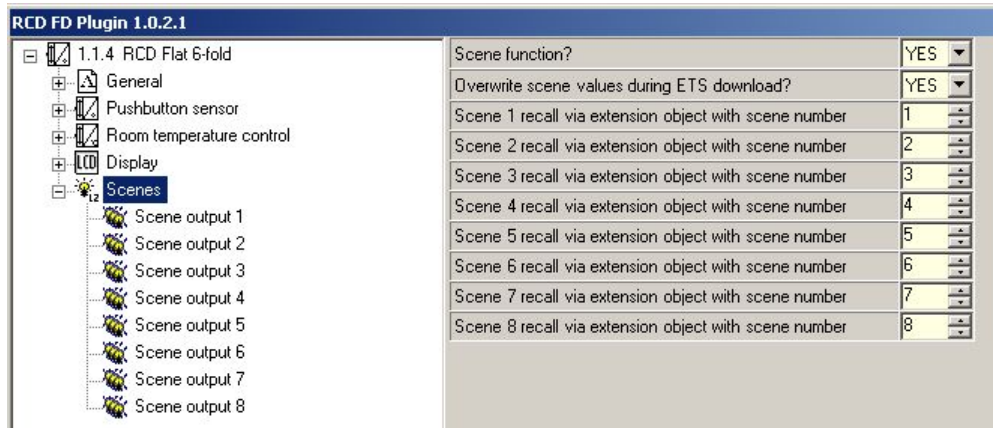

These internal scenes can be recalled directly via the rockers or keys (function "internal scene recall") and also by another bus device via the "scene extension input" communication object. This 1-byte communication object supports the evaluation of up to 64 scene numbers. For this reason it must be specified which of the external scene numbers (1 ... 64) is to recall the internal scene (1 ... 8). If the same scene number is listed for several internal scenes, it is always only the first of these scenes that will be activated (scene with the lowest scene number).

In some situations there may be the requirement that a group of actuators is not controlled by all but only by certain scenes. A classroom, for instance, may require open blinds for the "Welcome" and "Pause" scenes, closed blinds during the "PC-presentation" scene and no change in the "Discussion" scene. In this example, the parameter "Permit transmission?" can be set to "no" for the "Discussion" scene. The scene output is then deactivated during the corresponding scene.

The parameter "Transmit delay" permits entering an individual waiting time for each scene output. This transmit delay can be used in different situations...

- When the actuators participating in a scene transmit status messages automatically or when several scene keys are used to increase the number of channels within the scenes, the recall of a scene may result for a short time in high bus loading. The transmit delay helps to reduce the bus load at the time of scene recall.
- Sometimes, it is desirable that an action is started only after another action has ended. This can be, for instance, the lights which are to go out only after the blinds/shutters have been raised.

The transmit delay can be set separately for each scene output. The transmit delay defines the time between the individual telegrams during a scene recall. The setting specifies how much time must pass after the first scene telegram before the second telegram is transmitted. After sending the second scene telegram, the parameterized time must again pass before the third telegram is transmitted and so forth... The transmit delay for the first scene telegram starts immediately after the scene has been recalled.

Alternatively, the transmit delay between telegrams can also be deactivated (setting "0"). The telegrams are then transmitted at the shortest possible interval. In this case, however, the order of the telegrams transmitted can deviate from the numbering of the scene outputs.

When a new scene recall (also with the same scene number) occurs during a current scene recall - even in consideration of the pertaining transmit delays - the processing of the scene started before will be aborted and the newly received scene number will be processed. A running scene is also aborted when a scene is being stored!

During a scene recall - even if delayed - the control surfaces of the room controller are operational.

9.2 Storing scenes

For each output of a scene, the user can define a corresponding scene value in the ETS which is then transmitted to the bus during a scene recall. During the regular operation of the system it may be required to adapt these preset values and to store the adapted values in the room controller. This can be achieved with the storage function of the scene control.

The value storage function for the corresponding scene number is enabled with the parameter "Permit storage?" ("yes") or disabled ("no"). When the storage function is disabled, the object value of the corresponding output is disregarded during storage.

A scene storage process can be initiated in two different ways...

- by a long rocker or key actuation of a control surface parameterized as "scene extension,
- by a storage telegram to the extension object.

During a storage process, the room controller reads the current object values of the connected actuators. This is effected by means of eight read telegrams (ValueRead) addressed to the devices in the scene which return their own value (ValueResponse) as a reaction to the request. The returned values are received by the room controller and stored in the non-volatile memory of the scene. For each scene output, the room controller waits one second for a response. If no answer is received during this time, the value for this scene output remains unchanged and the room controller scans the next output.

In order to enable the room controller to read the object value of the actuator addressed when a scene is stored, the read flag of the corresponding actuator object must be set. This should be done only for one actuator out of an actuator group so that the value response is unequivocal.

The stored values overwrite those programmed into the room controller with the ETS.

The storage process will always be executed completely by the room controller and cannot not be aborted before it has ended. Recalling scenes in the course of a storage process is not possible, the control surfaces of the room controller remaining nevertheless operational.

10 Disabling of the keys

With the 1-bit communication object "Key disable", the control surfaces of the room controller can be partly or completely disabled. During a disable, the rockers or keys can temporarily execute other functions as well. An active disable affects only the functions of the rockers or keys. The functions of the status LED, room temperature measurement, scene function and the alarm message are not affected by the disabling function. The disabling function and the pertaining parameters and communication objects are enabled if the parameter "Disabling function ?" is set to "yes" on parameter page "Disabling functions".

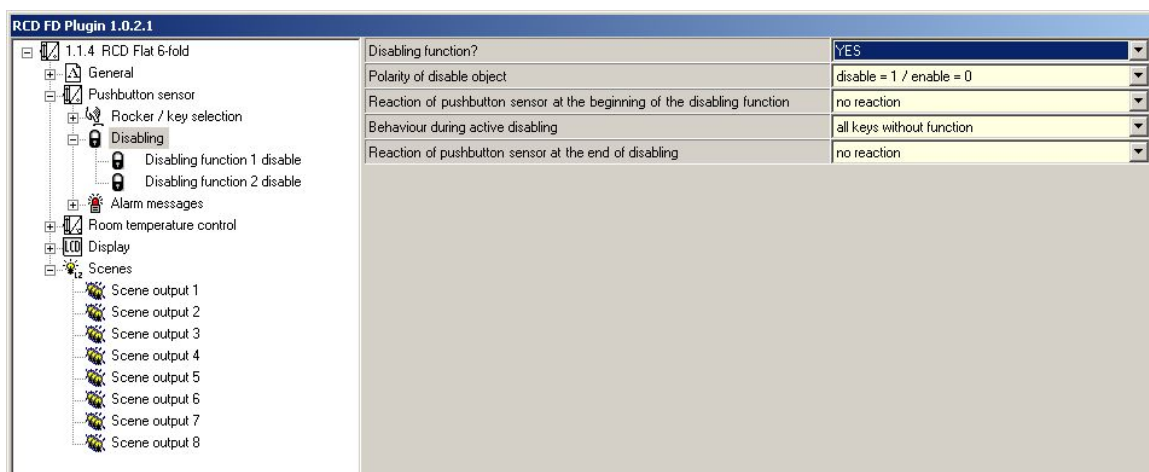

The polarity of the disable object is parameterizable. In case of polarity inversion (disabled = 0 / enabled = 1), the disabling function is not activated immediately after a reset or after ETS programming (object value = "0"). There must first be an object update "0" until the disabling function will be activated. Telegram updates from "0" to "0" or from "1" to "1" on the "Key disable" object remain without effect.

If the disabling function is used, the reaction of the room controller on activation and deactivation of the disabling function can be preset separately in the room controller parameters (parameter "Reaction of room controller at the beginning / end of disable"). In this connexion it is irrelevant which of the control surfaces is influenced and possibly also locked by a disabling function. The room controller always shows the parameterized behaviour. The following settings are possible...

- I. "No reaction":
The room controller shows no reaction at the beginning and at the end of disable. The sensor only adopts the state as provided for by the "Behaviour during active disable".
- II. "Internal scene recall 1 ...8":
The room controller recalls one of the 8 internal scenes max. Scene storage is not provided for.

III Reaction like key >> X << / >> Y << on pressing /releasing":

The room controller executes the function assigned to any of the "target keys" in non-disabled state. Target keys are control keys of the room controller which may be configured for rocker or for key operation. The target keys are parameterized separately for the beginning (X) of for the end (Y) of disabling (key X / Y: key to key 16 max.).For this purpose, the two keys of a rocker are considered as two separate keys.

The action parameterized for the respective target key is executed. If the target key is parameterized in such a way that it has no function or does not transmit a telegram on pressing or releasing of the key, then there is also no reaction to disabling or to re-enabling. If the selected target key is part of a parameterized rocker, the behaviour preset for the respective rocker side (rocker X.1 or X.2) will be used.

Table 1 shows all possible telegram reactions of the room controller with respect to the target key function.

Function of >>target key<<	reaction "like >>target key<< when pressed"	Reaction "like >>target key<< when released"
switching / toggling	switching telegram	Switching telegram
dimming	switching telegram	no telegram
Blind/shutter	move telegram	no telegram
scene extension	scene recall telegram	no telegram
value transmitter, 8 bits	value telegram	no telegram
value transmitter 2 bytes	value telegram	no telegram
temperature value transmitter	temperature value telegram	no telegram
brightness value transmitter	brightness value telegram	no telegram
2-channel operation channel 1: 1-bit object type	switching telegram	no telegram
2-channel operation channel 1: 1-byte object type	value telegram	no telegram
2-channel operation channel 1: 2-byte object type	temperature value telegram	no telegram
controller extension operating mode switch-over	operating mode telegram	no telegram
controller extension presence detection	presence telegram	no telegram
controller extension setpoint shift	step value telegram	no telegram
no function	no telegram	no telegram

Table 1: telegram reactions of the room controller depending on the target key function.

The telegrams are transmitted to the bus via the required communication object of the target key.

IV. "Reaction like disabling function 1 / 2 when pressed / released":

The room controller executes the function assigned to either of the two 'virtual' disabling functions. The disabling functions are internal key functions with independent communication objects and independent parameters. Except for the status LED, the setting possibilities available for disabling function 1 and disabling function 2 are the same as for the keys.

The respective parameterization of the predefined disabling function will be executed. If no function or no telegram is parameterized in the disabling function on pressing or releasing of a key, then there is also no reaction to disabling or to re-enabling.

Also for this case, table 1 shows all possible telegram reactions of the room controller depending on programming of the disabling function.

The telegrams are transmitted to the bus via the required communication object of the disabling function.

During disable, the control keys can be separately influenced independently of the room controller's behaviour at the beginning or at the end of disabling.

During disabling...

- all keys can be without function.
In this case, the room controller is completely locked during disabling. Pressing a key has no effect. The status LEDs of the disabled keys are without function (no key-press indication either). Only the "always ON" or "always OFF" state remains unaffected by the disabling function.
- all keys can behave like predefined keys.
All keys behave as defined in the parameters for the two specified reference keys of the room controller. The parameter "All even / odd keys behave during disabling like..." defines the reference keys (key 1 to key 4 max.) For all control keys with an even number (2, 4) and for all keys with an odd number (1, 3) it is possible to program not only different reference keys, but also identical reference keys. The two 'virtual' disabling functions of the room controller can also be parameterized as a reference key. The telegrams are transmitted to the bus via the communication objects of the specified reference keys. The status LEDs of the reference keys are activated depending on the respective function. The status LEDs of the disabled keys are without function (no key-press indication either). Only the "always ON" or "always OFF" state remains unaffected by the disabling function.
- individual keys can be without function.
Only the individually specified keys are locked during a disabling function. The other control keys remain unaffected by the disabling function. The keys that will be locked are defined in the parameters on the "Disable – Key selection" page. The status LEDs of the disabled keys are without function (no key-press indication either). Only the "always ON" or "always OFF" state remains unaffected by the disabling function.
- individual keys can behave like predefined keys.
Only the individually specified keys behave as defined in the parameters of the two specified reference keys of the room controller. The parameter "All even / odd keys behave during disabling like..." defines the reference keys (key 1 to key 16 max.) For all control keys with an even number (2, 4) and for all keys with an odd number (1, 3) it is possible to program not only different reference keys, but also identical reference keys. The two 'virtual' disabling functions of the room controller can also be parameterized as a reference key. The keys that will be locked are defined in the parameters on the "Disable – Key selection" page. The telegrams are transmitted to the bus via the communication objects of the specified reference keys. The status LEDs of the reference keys are activated depending on the respective function. The status LEDs of the disabled keys are without function (no key-press indication either). Only the "always ON" or "always OFF" state remains unaffected by the disabling function.

Notes on the activation and deactivation of a disabling function:

If a key scan is taking place at the time of activation / deactivation of a disabling function, this function is aborted immediately and with it also the pertaining key function. All keys must first be released before a new key function can be executed if so permitted by the disable state.

11 Controller extension:

11.1 Connection with the room temperature controller

For controlling of a KNX/EIB room temperature controller, the controller extension function can be activated. The controller extension function is enabled with the parameter "*Controller extension*" on the "*Room temperature control*" page.

The controller extension itself is not involved in the regulating process. With the controller extension function, the user can operate the single-room temperature regulation from different places in the room. The controller extension can also be used to adjust central heating control units which are located, for instance, on a sub-distribution board.

Typical KNX/EIB room temperature controllers generally offer different means of influencing or of visualizing the room temperature regulation.

- Switching over between different operating modes (e.g. "Comfort", "Night" ...) with different setpoint temperatures assigned to each mode by the controller
- Detecting the presence of a person in a room. The detection may also be combined with a parameterized change of the operating mode.
- Readjustment of the setpoint temperature in steps which are referred in each case to the parameterized setpoint temperature of the current operating mode (basic setpoint shift).

With its control keys, the room controller can fully control a room temperature controller by changing the operating mode, by predefining the presence situation or by readjusting the setpoint shift (cf. the following sub-chapters). The room controller keys selected as control elements for the extension unit must be parameterized for this purpose as "*Controller extension*". It should be noted that an extension operation is possible only if one control surface is configured as a key and if the controller extension function has been enabled on the "*Room temperature control*" page. In all other cases, the controller extension function is not operational.

In addition, the room controller can – independent of the controller extension function – indicate the state of one or more room temperature controllers with the status LEDs of the keys or rockers. This feature permits the indication of operating modes or the bit-oriented evaluation of different status objects of controllers (cf. chapter "8. Status LEDs").

In case of the controller extension functions "Setpoint shift" or "Presence function", the status LEDs can also signal the state of the corresponding functions directly.

The controller extension can work properly only if all extension objects are linked with the corresponding objects of the room temperature controller. The controller extension with the objects is existent only once in the room controller. All key functions parameterized for the controller extension act on the objects belonging to the extension. Several controller extensions can also act on one master controller.

The communication objects "Operating mode switch-over", "Forced operating mode switch-over", "Presence key", "Setpoint shift input" and "Controller status" of the controller extension updates themselves automatically after a reset of the room controller or after an ETS programming operation, if the parameter *"Request value from controller extension"* on parameter page *"Room temperature control"* is set to "yes". Updating is effected by means of a ValueRead telegram to the room temperature controller. The controller must answer the request with a ValueResponse telegram. If the room controller does not receive all or some of the answers, the affected objects are initialized in the room controller with "0". In this case, the objects must first be actively rewritten by the bus after a reset. This is also the case, if the *"Request value from controller extension"* parameter is set to "no".

11.2 Key functions "Operating mode switch-over" and "Forced operating mode switch-over"

Switch-over of the controller operating mode can be effected in accordance with the standard function block for room temperature controllers defined in the Konnex handbook with two 1-byte communication objects. A distinction is made between operating mode switch-over via the normal and the forced-control object. The "Operating mode switch-over" object offers a selection between the following operating modes...

- comfort operation
- standby operation
- night-time operation
- frost / heat protection

The "Forced operating mode switch-over" communication object has the higher priority. The "Forced operating mode switch-over" object permits forced switching between the following modes of operation...

- Auto (normal operating mode switch-over)
- comfort operation
- standby mode
- night-time operation
- frost / heat protection

The operating mode transmitted to the bus when a controller extension key is pressed is defined by the parameter "Operating mode on key-press". Depending on the parameterized functionality, it is possible that ...

- either one of the above-mentioned modes is activated (single selection) on the press of the key,
- or the device is switched over between two or three modes (multiple selection).

Notes on multiple selection:

In order to ensure that a switch-over from one mode into another works properly even from different locations, the operating mode objects of the controller and those of all controller extension room controllers must be interlinked and have their "Write" flag set. In the objects concerned this flag is set by default.

By checking the linked operating mode switch-over object, the controller extension knows which of the possible operating modes is active. Based on this information, the device switches over into the next operating mode in sequence when a key is pressed. In the event that none of the possible operating modes is active, the next operating mode in the sequence is set to "Comfort" operation (in case of "Standby ->Night" to "Standby"). As far as the switch-overs between the forced operating modes and "Auto" is concerned, the device switches into the "Auto" operating mode when none of the parameterized operating modes is active.

It is not possible to program a reaction on release of the key. A long key-press is evaluated in the same way as a short one and switches into the corresponding mode of operation in so far as this is allowed for the controller.

If a status LED is to indicate the current mode of operation, it must be programmed for "Operating mode indication" and its status object be linked with the corresponding group address for switching with normal or high priority (cf. chapter "8. Status LEDs").

11.3 Key function "Presence key"

All keys with their functions set to "Presence key" are internally linked with the "Presence key" object of the controller extension. The parameter "Presence function on key-press" defines the object value transmitted to the bus on pressing a key.

In order to ensure that the object value transmitted in the "Presence TOGGLE" setting is always the correct one, the presence object of the room temperature controller and the "Presence key" objects of the controller extensions of the room controllers must be interlinked and have their "Write" flag set. In the extension objects concerned this flag is set by default.

It is not possible to program a reaction on release of the key. A long key-press is evaluated in the same way as a short one and switches into the corresponding presence state in so far as this is admissible for the controller.

The status LED of the presence key can indicate both the presence status (setting "Key function indication active / inactive") and also the actuation of the key. In addition, the usual setting options for the status LED are parameterizable as well (cf. chapter "8. Status LEDs").

11.4 Key function "Setpoint shift"

The setpoint shift is another available function of the controller extension. It makes use of two 1-byte communication objects with datapoint type 6.010 (integer with sign). This extension function allows to shift the basic setpoint for the temperature on the room temperature controller by actuating a key. Operation of the controller extension is generally the same as the operation of the controller master.

A key parameterized as setpoint shifting key reduces or increases the setpoint shift value on each press by one step respectively. The direction of the value variation is defined by the parameter "Setpoint shift on key-press". Releasing the key and a long press have no other functions.

Communication with main controller:

In order to enable the room controller to effect a setpoint shift in a room temperature controller, the controller must have input and output objects for setpoint shifting. In this case, the output object of the controller must be linked with the input object of the extension and the input object of the controller must be linked with the output object of the extension via an independent group address.

All objects are of the same datapoint type and have the same value range. A setpoint shift is interpreted by object values: a shift in positive direction is expressed by positive values whereas a shift in negative direction is represented by negative object values. An object value of "0" means that no setpoint shift has been activated.

Via the "Setpoint shift input" object of the controller extensions which is linked with the room temperature controller the extensions are enabled to determine the current setpoint shift position. Starting from the value of the communication object, each key-press on an extension will adjust the setpoint in the corresponding direction by one counting step. Each time the setpoint is adjusted, the new shift is transmitted to the room temperature controller via the "Setpoint shift output" object of the controller extension to the room temperature controller. The controller itself checks the received value for the minimum and maximum temperature limits (see controller documentation) and adjusts the new setpoint shift if the values are valid. When the new count value is accepted as valid, the controller transfers this value to its output object for setpoint shifting and retransmits the value to the extension as positive feedback.

Due to the standard datapoint type used as the output and input object of the controller extension and the weighting of the individual step by the controller itself, each extension is able to determine whether a shifting took place, in which direction it took place and by how many steps the setpoint was shifted. This requires that the communication objects in all controller extensions and in the controller are linked.

The information about the step value as feedback from the controller enables the extension to continue the adjustment anytime at the right point. The extensions can equally react to a reset of the setpoint shifting function by the controller.

The status LED of a setpoint shifting key can indicate both the setpoint shifting status (setting "Setpoint shift indication") and also the actuation of the key. In addition, the usual setting options for the status LED are parameterizable as well (cf. chapter "8. Status LEDs").

For setpoint shifting status indication, the controller makes use of the step count value which is transmitted to the extension and evaluated for switching of the status LED. The "Status LED" parameter defines the switching behaviour: The LED can be permanently off and light up only after a shift has been detected (setting "ON, ..."). As an alternative, the LED can be permanently on and go out only after a shift has been detected (setting "OFF, ..."). It can also be distinguished whether the LED is ON or OFF only if ...

- there has been shifting at all
- only a positive shift has been detected,
- only a negative shift has been detected.

12 Alarm message

The room controller permits signalling of a alarm which might be, for instance, a burglar or a fire alarm from a KNX/EIB central alarm unit. An alarm is signalled by all status LEDs and the operation LED of the room controller blinking synchronously. This display alarm can be separately enabled with the parameter "Display alarm message" on parameter page "Alarm message" so that it can be used.

When alarm signalling is enabled, the ETS displays the communication object "Alarm message" and further alarm function parameters.

The alarm message object is used as an input for activating or deactivating the indication of the alarm. The polarity of this object can be selected. When the object value corresponds to the "alarm" condition, all status LEDs and the operation LED are always blinking with a frequency of ca. 2 Hz. In case of an alarm, the basic parameters set for the LEDs are of no importance. The LEDs adopt their originally parameterized behaviour only after the alarm signalling function has been deactivated. Changes of the state of the LEDs during an alarm - if they are controlled by separate LED objects or if they signal key functions - are internally stored and recovered at the end of the alarm.

Apart from the possibility of deactivating an alarm message indication via the alarm object, it can also be deactivated locally by a key-press on the room controller itself. The parameter "Reset alarm message by key-press?" defines the key response during an alarm...

If this parameter is set to "Yes", active alarm signal displaying can be deactivated by a key-press on the room controller. This key-press does not cause the parameterized function of the pressed key to be executed. Only after then next key-press will the parameterization of the key be evaluated and a telegram be transmitted to the bus, if applicable.

If "No" has been selected, alarm signalling can only be deactivated via the alarm signalling object. A key-press will always directly execute the parameterized key function.

If an alarm message indication can be deactivated by a key-press, the parameter "Acknowledge alarm message by" defines whether this key-press transmits an additional alarm acknowledge telegram to the bus via the separate object "Alarm signalling acknowledge".

Such an acknowledge telegram can, for instance, be sent via a 'listening' group address to the "Alarm message" objects of other room controllers in order to reset the alarm status there as well. Attention must be paid during resetting of an alarm to the selectable polarity if the acknowledge object.

Notes on the alarm message indication function:

Polarity of the alarm object: If the setting is "Alarm when OFF and alarm reset when ON", the alarm object must be actively written by the bus with "0" to activate the alarm after a reset or after programming with the ETS.

An active alarm message is not stored so that the alarm message indication is generally deactivated after a reset or after programming with the ETS.

13 Room temperature controller functions

The room temperature controller supports the three control options "heating", "cooling" and "heating and cooling". In all three control options, the controller can work in different operating modes to which different setpoint temperatures are assigned. The following diagrams show these setpoint temperatures and their graduations.

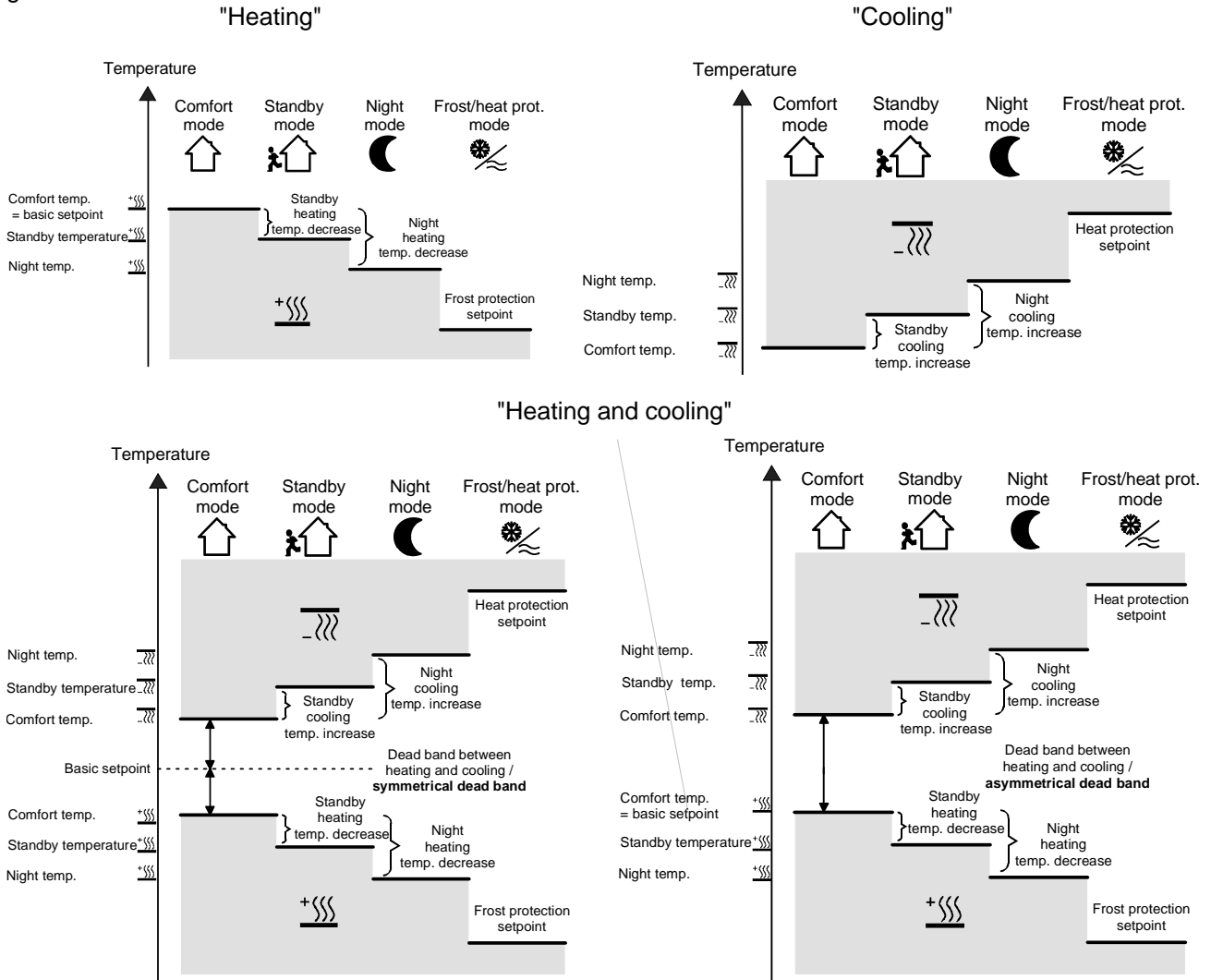

Temperature control with additional stage considering as an example "heating and cooling" with symmetrical dead zone...

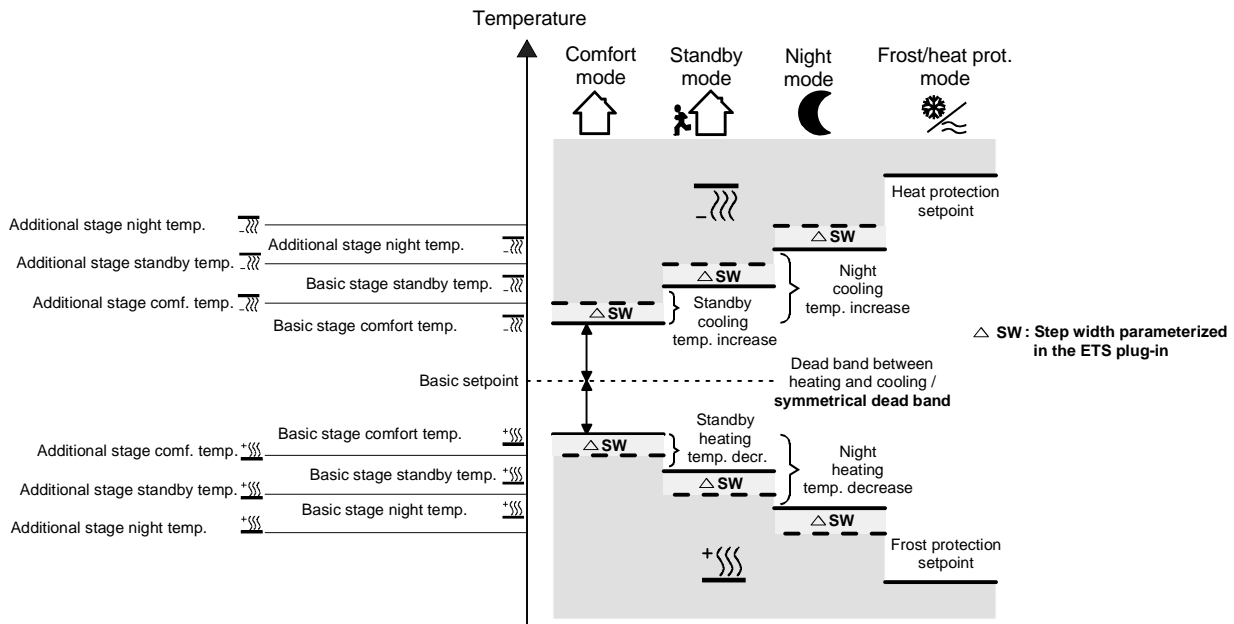

If enabled in the ETS, 6 temperature setpoints can be varied in "heating and cooling" control option. Depending on the temperature decrease, increase or dead zone parameterized in the ETS, all temperature setpoints are derived from the basic setpoint temperature.

It must be pointed out that changing the setpoint temperature for heating in the comfort mode will also change all other setpoint temperature values!

The dead zone (temperature zone for which there is neither heating nor cooling) is the difference between the setpoint temperatures for "heating" and "cooling" in the comfort mode. The following applies:

$$T_{\text{comfort setpoint cooling}} - T_{\text{comfort setpoint heating}} = T_{\text{dead zone}}; T_{\text{comfort setpoint cooling}} \geq T_{\text{comfort setpoint heating}}$$

Important notes:

- If the dead zone is symmetrical, the basic setpoint is indirectly set via the comfort temperature for heating.
- Changing the comfort setpoint temperature for cooling allows the adjustment of the dead zone. An adjustment of the dead zone with a symmetrical dead zone position will result in a shift of the comfort setpoint temperature for heating and thus of all other temperature setpoints. With an asymmetrical dead zone position, an adjustment of the comfort setpoint temperature for cooling will only shift the temperature setpoints for cooling. It is possible to shift the dead zone to 0 °C via local control ($T_{\text{comfort setpoint cooling}} = T_{\text{comfort setpoint heating}}$). In this case there is neither heating nor cooling, if the determined room temperature equals the comfort setpoint temperatures.

The setpoint temperatures for "Standby" and "Night" are derived from the comfort setpoint temperatures for heating or cooling. The temperature increase (for cooling) and the temperature decrease (for heating) of both operating modes can be preset in the ETS.

It is possible to adjust the setpoint temperatures for "Standby" and "Night" via local control in the programming mode independent of the values for the temperature increase/decrease which were originally parameterized in the ETS.

In this case, the standby or night setpoint temperatures will always shift together with the temperature increase/decrease resulting from the local control during the adjustment of the basic setpoint temperature or the dead zone. After the reprogramming with the ETS, the originally parameterized values can be accepted again.

The following applies...

$$T_{\text{standby setpoint heating}} \leq T_{\text{comfort setpoint heating}} \leq T_{\text{comfort setpoint cooling}} \leq T_{\text{standby setpoint cooling}}$$

or

$$T_{\text{night setpoint heating}} \leq T_{\text{comfort setpoint heating}} \leq T_{\text{comfort setpoint cooling}} \leq T_{\text{night setpoint cooling}}$$

In case of a two-stage control the setpoints of the additional stage are always derived dynamically from the setpoints of the basic stage. The temperature setpoints of the additional stage are predefined by the stage offset which is parameterized in the ETS. The stage offset cannot be adjusted in the local control mode.

As far as a change of the basic setpoint temperature is concerned (when a new comfort setpoint temperature value for heating is being received by the "Basic setpoint" communication object), there are basically two cases which must be distinguished:

- Case 1: The basic setpoint change is permanently adopted,
- Case 2: The basic setpoint change is adopted only temporarily (default).

Via the "*Adopt basic temperature setpoint change permanently*" parameter on the "*Room temperature controller function /setpoints*" parameter page, it is possible to determine whether the changed basic temperature value shall be stored in memory permanently ("*yes*") or only temporarily ("*no*").

Case 1:

If the basic temperature setpoint is changed, it will be permanently stored in the room temperature controller's EEPROM. The newly adjusted value will overwrite the basic temperature originally parameterized with the ETS!

It should be noted, however, that frequent adjustments of the basic temperature (e.g. several times a day) can affect the product life of the device as the non-volatile memory is designed only for less frequent write access.

Thus the basic setpoint received by the object remains in memory even after a bus voltage failure.

Case 2:

The basic setpoint received via the object stays only temporarily active in the current operating mode. In case of a bus voltage failure or following a switch-over into another operating mode (e.g. comfort followed by standby), the basic setpoint adjusted via local operation or received via the object will be discarded and replaced by the value which was originally parameterized in the ETS.

Important:

- Since the setpoint temperatures for the "standby" and "night" operating modes or the setpoints for the "cooling" control option are derived - in consideration of the increase, decrease or dead zone values that are parameterized in the ETS - from the basic setpoint temperature for "heating", these setpoint temperatures will shift linearly by the change of the basic setpoint value.

The temperature setpoints for the standby or night mode or "cooling" comfort mode (dead zone) will always be stored in the non-volatile EEPROM.

- It has to be pointed out that temperature setpoints can only be changed or stored via local control or via the "Basic setpoint" object, if it was enabled in the ETS. Any value preset via local control will not be adopted by the object.

13.1 Operating modes

The room temperature controller features several operating modes. By selecting these modes it is possible to activate different temperature setpoints that, for example, depend on the presence of a person, the status of the heating or cooling system, the time of day or day of week.

- Comfort mode:

The comfort mode should be activated if people are present in the room that requires the room temperature to be adjusted to a comfortable and appropriate value. The switch-over into this operating mode can also take place via presence control.

The comfort mode - when activated - is signalled by LED B (🏠).

- Standby mode

If a room is not in use during the day as people are absent, the standby mode may be activated. This will set the room temperature to a standby value so that heating or cooling energy can be saved in the process.

The standby mode - when activated - is signalled by LED C (🏠).

- Night mode

During the night hours or during a longer absence it is often best to adjust the room temperature to cooler temperatures for heating systems (e.g. in bedrooms). In this case, cooling systems can be adjusted to higher temperature values, if climate control is not required (e.g. in offices). For this purpose the night mode can be activated.

The night mode - when activated - is signalled by LED D (🌙).

- Frost / heat protection mode

Frost protection is necessary, if, for example, the room temperature must not fall below critical values when the window is open. Heat protection might be necessary, if the temperature in a mostly warm environment becomes too high due to external influences.

In these cases, freezing or overheating of the room can be prevented by activating the frost/heat protection depending on the adjusted "heating" or "cooling" control option by specifying an individual temperature setpoint.

A frost/heat protection - when activated - is signalled by LED H (🌸).

- Comfort mode prolongation (temporary comfort mode)

The comfort mode prolongation is to be activated from the night mode or the frost/heat protection (not triggered by the "window state" object) and can be used to adjust the room temperature to the comfort temperature for a certain amount of time, if, for example the room 'is used' during the night as well. The prolongation is activated exclusively by a parameterized presence key. The comfort mode prolongation is automatically deactivated after a settable time has elapsed or by pressing the presence key again or via receiving a presence object value = "0". The prolongation cannot be retriggered.

An individual temperature setpoint can be preset for each "heating" or "cooling" control option.

13.1.1 Operating mode switch-over

There are several ways to activate or switch-over the operating modes. Activating or switching-over – interdependent in terms of priority – are possible via...

- a) local operation of the presence key, if enabled,
- c) the 1-bit objects that are available separately for each operating mode or alternatively via the KONNEX objects (1 byte).

Ad a):

If the presence key has been selected for presence detection on parameter page "Controller functions", the presence key can be used to switch from the night mode or from the frost/heat protection mode over to the comfort mode for the preset comfort prolongation time on provision that the above modes have not been activated by the "Window state" object. The comfort mode prolongation is deactivated after this time has elapsed, after a new press on the presence key or after receiving a presence object value = "0". If the duration of the comfort prolongation is set to "0", the presence function can be activated, but the operating mode is not changed. During the comfort prolongation period, the comfort LED is lit up together with the "night mode" or the "frost/heat protection" LED.

If the standby mode is active, it is possible to switch into the comfort mode by actuating the presence key or via a presence object value = "1".

Ad b):















One distinguishes whether the operating mode is to be switched-over via separate 1-bit objects or, alternatively, via the 1-byte KONNEX objects. The "Operating mode switch-over" parameter on the "Room temperature controller function" parameter page predefines how the switch-over will take place.

- Operating mode switch-over via "switching (4 x 1 bit):

There is a separate 1-bit switch-over object for each operating mode. Each one of these objects allows to switch-over or to preset the current operating mode by priority.

Taking into consideration the priority, the following switch-over hierarchy results from an operating mode switch-over via the objects. One distinguishes between presence detection by presence key (table 1 / figure 1) and by presence detector (table 2 / figure 2 on next page):

Table 1

"Operating mode switch-over" objects:				Window status Obj.-No. 88	Presence key object Obj.-No. 87	activated operating mode
 Obj.-No. 85	 Obj.-No. 82	 Obj.-No. 83	 Obj.-No. 84			
X	X	X	X	1	X	Frost / heat protection 
1	X	X	X	0	0	Frost / heat protection 
0	1	X	X	0	0	Comfort 
0	0	1	X	0	0	Standby 
0	0	0	1	0	0	Night 
1	X	X	X	0	1	Comfort mode prolongation  
0	1	X	X	0	1	Comfort 
0	0	1	X	0	1	Comfort 
0	0	0	1	0	1	Comfort mode prolongation  
0	0	0	0	0	0	last selected valid mode
0	0	0	0	0	1	Comfort / comfort mode prolongation *

X = irrelevant

*: Depends on the last selected valid operating mode.

Fig. 1:

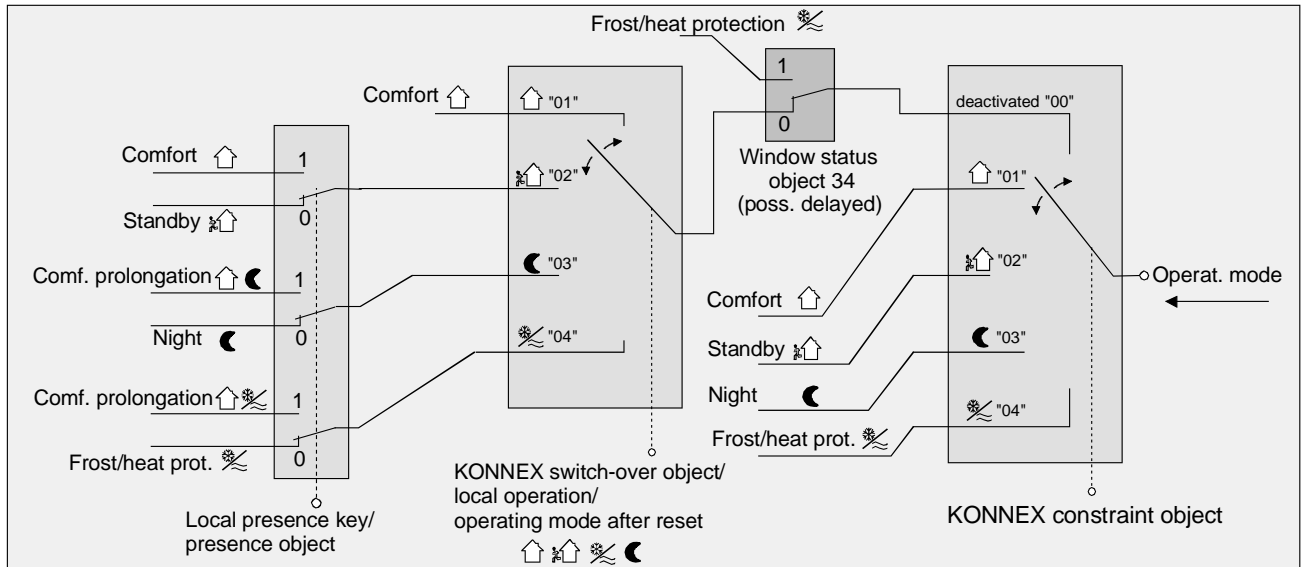
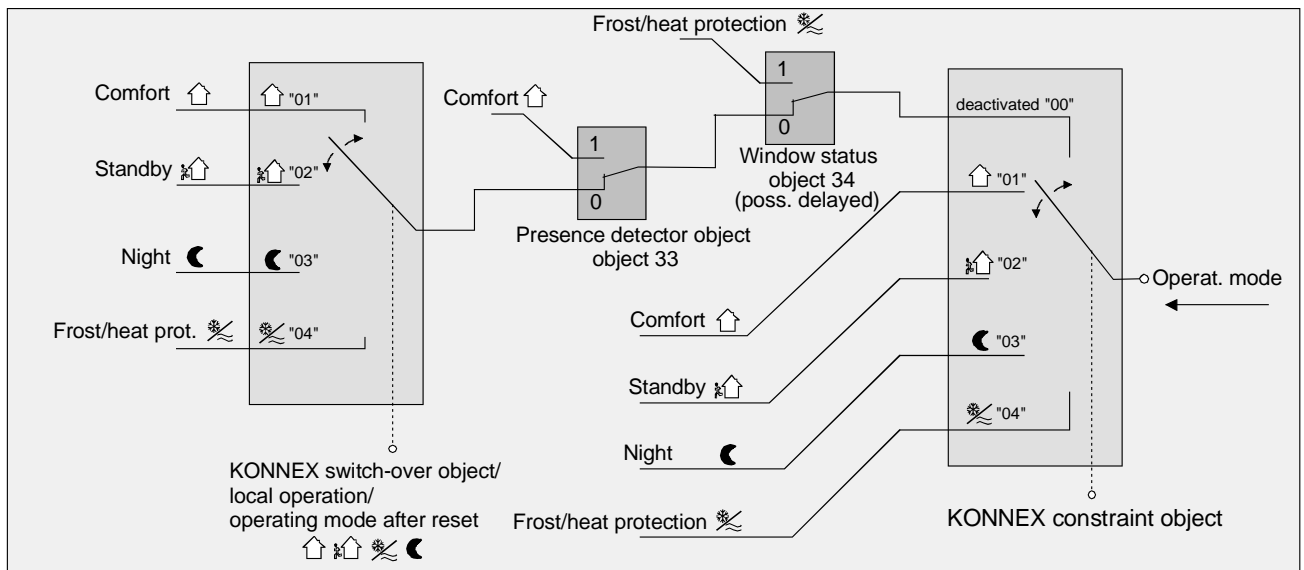

Table 2

"Operating mode switch-over" objects:				Window status Obj.-No. 88	Presence detector object Obj.-No. 87	activated operating mode
Obj.-No. 85	Obj.-No. 82	Obj.-No. 83	Obj.-No. 84			
X	X	X	X	1	X	Frost / heat protection
X	X	x.y	x.y	0	1	Comfort
1	x.y	x.y	x.y	0	0	Frost / heat protection
0	1	x.y	x.y	0	0	Comfort
0	0	1	x.y	0	0	Standby
0	0	0	1	0	0	Night
0	0	0	0	0	0	last selected valid mode

X = irrelevant

Fig. 2:

















Notes on operating mode switch-over via "Switching" (4 x 1-bit):

- When the operating modes are switched-over, the objects, too, (comfort mode / standby mode / night mode / frost/heat protection) will always be updated and can, if applicable, be read out (set "read" flag!). Once the "transmission" flag is set for these objects, changed values will also be actively transmitted to the bus. Following a return of bus voltage or an initialization, the object corresponding to the set operating mode will be updated and its value actively transmitted to the bus when the "transmission" flag is set.
- When parameterizing a presence key:
The presence object is active "1" for the duration of an activated comfort mode prolongation.
The presence object will be automatically deleted ("0"), if the comfort mode prolongation is terminated after the prolongation time has elapsed or if the operating mode has been switched by a higher-priority control via the switch-over objects or via local operation.
- The operating mode switch-over via "value" (2 x 1-byte):

A shared 1-bit switch-over object exists for all operating modes. Via this value object, the operating mode can instantly be switched over after receiving only one telegram. The received value will determine the operating mode. In addition, there is a second 1-byte object available which can (by forced control and higher ranking) set an operating mode independent of all other available switch-overs. Both 1-byte objects are implemented according to the KONNEX specification.

Taking into account the priorities there is the following switching hierarchy for an operating mode switch-over by objects, with a distinction being made between a presence detection via presence key (table 1 / figure 1) and by presence detector (table 2 / figure 2 on next page):

Table 1

"Operating mode switch-over" object Obj.-No. 82	"Operating mode forced-control" object *** Obj.-No. 86	Window status Obj.-No. 88	Presence key object Obj.-No. 87	activated operating mode
x.y	01	x.y	x.y	Comfort 
x.y	02	x.y	x.y	Standby 
x.y	03	x.y	x.y	Night 
x.y	04	x.y	x.y	Frost / heat protection 
x.y	00	1	x.y	Frost / heat protection 
01	00	0	0	Comfort 
02	00	0	0	Standby 
03	00	0	0	Night 
04	00	0	0	Frost / heat protection 
01	00	0	1	Comfort 
02	00	0	1	Comfort 
03	00	0	1	Comfort mode prolongation  
04	00	0	1	Comfort mode prolongation  
00	00	0	0	last selected valid mode
00	00	0	1	Comfort / comfort mode prolongation *

*: Depends on the last selected valid operating mode. / X = irrelevant

** : Values greater than "04" will not be evaluated. A "00" value will leave the last selected valid operating mode active.

***: Values greater than "04" will not be evaluated. A "00" value signifies that the forced-control object is deactivated.

Fig. 1:

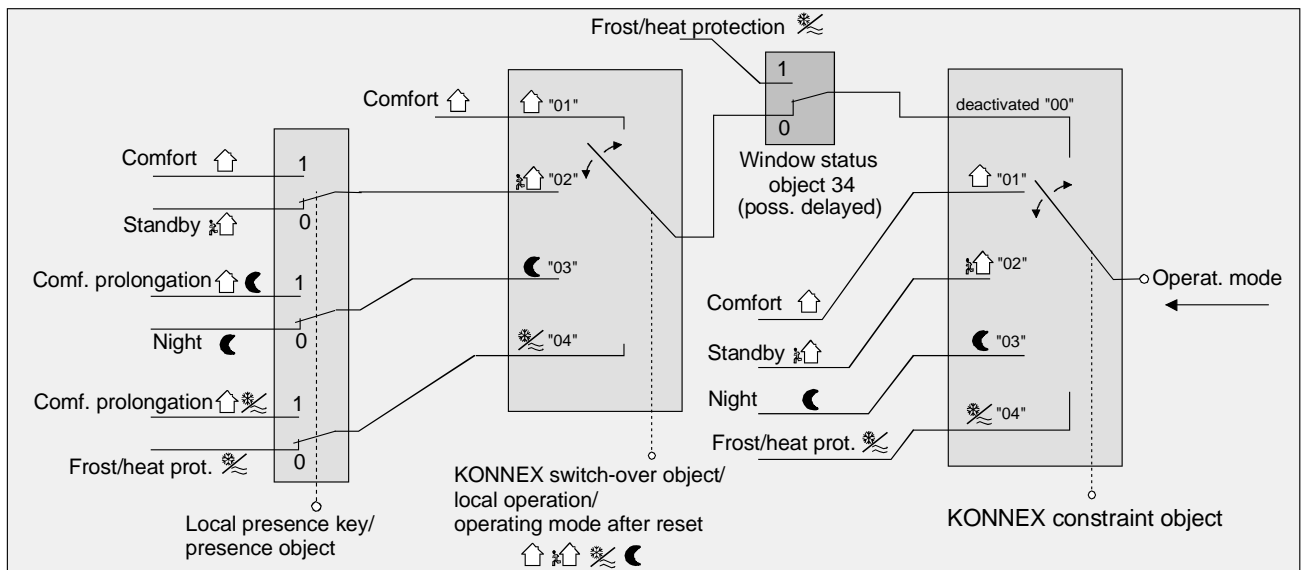

Table 2

"Operating mode switch-over" object Obj.-No. 82	"Operating mode forced-control" object *** Obj.-No. 86	Window status Obj.-No. 88	Presence detector object Obj.-No. 87	activated operating mode
x.y	01	x.y	x.y	Comfort
x.y	02	x.y	x.y	Standby
x.y	03	x.y	x.y	Night
x.y	04	x.y	x.y	Frost / heat protection
x.y	00	1	x.y	Frost / heat protection
x.y	00	0	1	Comfort
01	00	0	0	Comfort
02	00	0	0	Standby
03	00	0	0	Night
04	00	0	0	Frost / heat protection
00	00	0	0	last selected valid mode

X = irrelevant

** : Values greater than "04" will not be evaluated. A "00" value will leave the last selected valid operating mode active.

*** : Values greater than "04" will not be evaluated. A "00" value signifies that the forced-control object is deactivated.

Fig. 2:

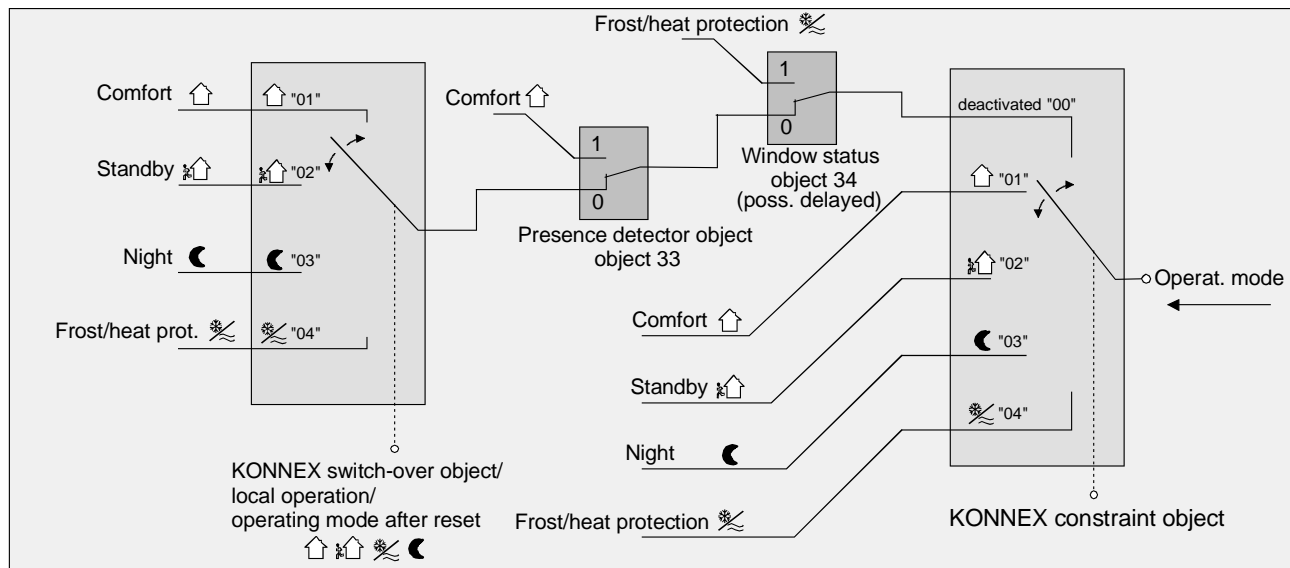

Notes for operating mode switch-over via "switching" (2 x 1-byte):

- Any operating mode switch-over will also update the KONNEX switch-over object and can be, if applicable, read out (set "read" flag!). If the "transmission" flag is set with this object, the current value will actively transmitted to the bus following a change. After a return of bus voltage or an initialization, the value corresponding to the adjusted operating mode will be actively transmitted on the bus if flag is set to "transmission". In case controller extensions are used, the "transmission" flag must also be set!
- When parameterizing a presence key:
The presence object is active ("1") for the duration of an activated comfort mode prolongation.
The presence object will automatically be deleted ("0"), if the comfort mode prolongation is terminated after the elapsed prolongation time, if the operating mode has been switched by a higher-priority control via the switch-over objects or local operation or if a forced operating mode has been deactivated via the KONNEX forced-control object (forced-control object → "00").

13.1.2 Notes on the operating modes

Presence function / comfort mode prolongation:

Via a presence detection the room temperature controller can switch into the comfort mode prolongation for a short time when a key is pressed or into the comfort mode if movement is detected. The "*Presence detection*" and "*Type of presence detection*" parameters on the "Room temperature controller function – functions" parameter page determine whether the presence detection is controlled by movement via the presence detector or manually by pressing the presence key:

- Presence detection via presence key:

If the presence key is enabled as the type of presence detection, the setting "*Presence key*" can be selected under key functions. In addition, object 33, the "*presence object*", is enabled.

That way, it is possible to switch into the comfort mode prolongation during activated night mode or frost/heat protection (not activated via the "window status" object) by actuating the presence key or via a presence object value = "1". The prolongation is automatically deactivated as soon as the parameterized "*Duration of comfort mode prolongation*" has elapsed. A comfort mode prolongation can be prematurely deactivated, if the presence key is pressed again or if a value = "0" is received by the object. Retriggering of the prolongation time is not possible.

If the duration of the comfort mode prolongation is set to "0", it will not be possible to activate a comfort mode prolongation from the night mode or the frost/heat protection. In this case, the operating mode is not changed even though the presence function is activated.

If the standby mode is active, it is possible to switch into the comfort mode by actuating the presence key or via a presence object value = "1". This will also be the case, if the duration of the comfort mode prolongation is parameterized to "0". The active mode remains active for as long as the presence function is activated or until there is another operating mode.

The presence object or the presence function will always be deleted when switching over into another operating mode or after a forced-control operating mode has been deactivated (with KONNEX forced-control switch-over). The presence object is bi-directional ("W" and "T" flags set to default) so that an activation (= "1") or a deactivation (= "0") of the presence function will result in a transmission of telegrams with the corresponding object value. A presence function including the object that was activated before a reset will always be deleted after the reset.

- Presence detection by the presence detector:

If a presence detector is enabled for presence detection purposes, only the object 33, the "*Presence object*", will be visible. This object can be used to incorporate presence detectors in the room temperature control.

If any movement is detected ("1" telegram), the controller will switch into the comfort mode. The presettings by the switch-over objects or via local control directly on the touch sensor itself are not relevant. Only a window contact or the automatic frost protection or the KONNEX forced-control object have a higher priority.

After the delay time in the presence detector has elapsed ("0" telegram), the controller switches back into the mode which was active before the presence detection or it will track the telegrams of the switch-over objects received during the presence detection.

Switching-over of the operating mode on the room temperature controller is not possible while the presence detection is active.

A presence function that was activated before a reset will always be deleted after the reset. In this case the presence detector has to transmit a new "1" telegram in order to activate the presence function.

- Window status / automatic frost protection:

The room temperature controller provides different ways of switching into the frost/heat protection . Besides switching by means of the corresponding operating mode switch-over object, the frost/heat protection can be activated by a window contact. Among these options, the window contact has the higher priority.

A telegram with the value = "1" (opened window) to object 34 will activate the frost/heat protection. In this case, the operating mode cannot be deactivated by the operating mode switch-over objects (with the exception of the KONNEX forced-control object).

Only a telegram with the value = "0" (closed window) will reset the window status and deactivate the frost/heat protection. Subsequently, the operating mode that was set before the opening of the window or tracked via the bus during the time the window was open will be activated.

Operating mode after reset:

In the ETS it is possible to determine via the "*Operating mode after reset*" parameter on the "*Room temperature controller function – functions*" parameter page which operating mode is to be activated following a return of bus voltage or a programming operation with the ETS. The following settings are possible:

- "*Comfort mode*": After the initialization phase the comfort mode is activated.
- "*Standby mode*": After the initialization phase the standby mode is activated.
- "*Night mode*": After the initialization phase the night mode is activated.
- "*Frost/heat protection*": After the initialization phase the frost/heat protection is activated.
- "*Restore operating mode before reset*": The mode that was activated before a reset will be readjusted after the initialization phase of the device.

The objects associated with the activated operating mode will be updated after a reset.

Notes on the setting "*Restoring operating mode before reset*":

- Frequent changes of the operating mode during the operation (e.g. several times a day) may affect the product life of the device as the non-volatile storage (EEPROM) is designed only for less frequent write access.
- A presence function including the object that was activated before a reset is deleted after the reset. The operating mode activated by the presence function, however, remains active after the reset.

A comfort mode prolongation which was restarted by a reset is automatically deactivated after the prolongation time has elapsed.

The "*Window status*" object is deleted after a reset ("0"). In this case, too, the frost/heat protection which was previously activated via the window status remains activated even after a reset.

13.1.3 Controller status

The room temperature controller is able to transmit its status. Available is either a general collective status report (1-byte) or alternatively one of up to 8 individual status reports (1-bit).

The "Status controller" parameter on the "Room temperature controller function – actuating variable and status output" parameter page releases the status report and determines the status format:

- "Status controller" = "controller general":

The 1-byte status object 36 holds the complete status information. The status - controlled by the control algorithm – is actively transmitted (cyclically every 30 seconds) to the bus (pre-condition: "T" flag is set!). The setting of the "R" flag allows the read-out of the status.







Settings	Relevance of data	
Controller general 1-byte	Bit 0: 1: comfort mode active Bit 1: 1: standby mode active Bit 2: 1: night mode active Bit 3: 1: frost/heat protection active	Bit 4: 1: controller disabled Bit 5: 1: heating; 0: cooling Bit 6: 1: controller inactive (dead zone) Bit 7: 1: frost alarm (T room ≤ + 5 °C)

- "Status controller" = "Transmit individual status":

The 1-bit status object 36 includes the status information selected by the "individual status" parameter. The status - controlled by the control algorithm – is actively transmitted (cyclically every 30 seconds) to the bus (pre-condition: "T" flag is set!). The setting of the "R" flag allows read-out of the status.

Parameterization for "Individual status"	Relevance of data	
Comfort mode active	1: comfort mode / prolongation active	0: no comfort mode
Standby mode active	1: standby mode active	0: no standby mode
Night mode active	1: Night mode active	0: no night mode
Frost/ heat protection active	1: frost/heat protection active	0: no frost/heat protection
Controller disabled	1: controller disabled (dew-point mode)	0: controller not disabled
Heating/cooling	1: heating operation	0: cooling operation
Controller inactive	1: controller inactive (dead zone)	0: controller active
Frost alarm	1: frost alarm (T room ≤ + 5 °C)	0: no frost alarm (T room > + 5 °C)

Meaning of status reports:

- Comfort operation: active when operating mode "comfort"  or when comfort mode prolongation  or  is activated.
- Standby operation: active when operating mode "standby"  is activated.
- Night-time operation: active when operating mode "night"  is activated.
- Frost/ heat protection: active when operating mode "frost/heat protection"  is activated.
- Controller disabled: active when controller disable is activated (dew-point mode).
- Heating/cooling: active when heating is activated and inactive when cooling is activated. (inactive with controller disabled.)
- Controller inactive: active in the case of the "heating and cooling" control option when the measured room temperature lies within the dead zone. This status information is always "0" for the individual "heating" or "cooling" control options! (inactive when controller is disabled.)
- Frost alarm: active when the detected room temperature reaches or drops below + 5 °C. The status report has no significant influence on the controller behaviour.

Status object 36 will be updated following a reset after the initialization phase. Afterwards the status is updated every 30 seconds parallel to the calculation of the controller's actuating variable.

13.1.4 Additional controller status

The additional controller status is an object in which information already available on the bus is to be collected so that it can be displayed with a suitable device. This 1-byte object is a mere visualization object which does not allow any write access. This status object possesses a KNX-certified (but not standardized) datapoint type.

Settings for "Controller general"	Relevance of data for "Additional controller status report"	
Bit 0	1: normal operating mode	0: forced-control operating mode
Bit 1	1: comfort prolongation active	0: no comfort prolongation
Bit 2	1: presence (presence detector)	0: no presence (presence detector)
Bit 3	1: presence (presence key)	0: no presence (presence key)
Bit 4	1: window contact active	0: no window opened
Bit 5	1: additional stage active	0: additional stage not active
Bit 6	1: heat protection active (heat protection temp. < actual temp.)	0: no heat protection (heat protection temp. > actual temp.)
Bit 7	1: controller disabled (dew-point mode)	0: controller not disabled

Status object 57 will be updated following a reset after the initialization phase. Thereafter, the additional controller status is updated every 30 seconds parallel to the computation of the actuating variable of the controller. In the event of a change, the new status determined will be transmitted to the EIB.

13.2 Control options and control option switch-over

The room temperature controller features up to two control options. These control options determine whether the controller shall address heating systems (individual control option *"heating"*) or cooling systems (individual control option *"cooling"*) via its actuating variable. It is also possible to activate a mixed-mode in which the controller can switch-over automatically or, alternatively, object-controlled between *"heating"* and *"cooling"*.

Moreover, the control operation can be carried out in two stages for addressing an additional heating and cooling device. If controlled in two stages, actuating variables will be calculated separately for the basic and additional stage and transmitted on the bus depending on the deviation between actual and setpoint temperature.

The *"Control option"* parameter on the *"Room temperature controller functions"* parameter page determines the control option to be carried out and activates, if applicable, the additional stage(s).

For the individual control options *"heating"* or *"cooling"* without additional stage, the controller runs with only one actuating variable. Alternatively, it runs with two actuating variables for the parameterized control option, if the additional stage is activated. Depending on the determined room temperature and the preset setpoint temperatures of the operating modes, the room temperature controller decides independently whether heating or cooling energy is required and calculates the actuating variable for the heating or cooling system.

Following a reset (return of bus voltage or new ETS programming) in the *"heating"* or *"cooling"* mode, the controller will always operate in the control option that was set in the ETS.

In the *"heating and cooling"* mixed-mode the controller is able to address heating and cooling systems. In this case, the switch-over behaviour of the control options can be preset:

- The *"Switching-over between heating and cooling"* parameter on parameter page *"Room temperature controller-functions"* is set to *"automatic"*:

Depending on the determined room temperature and the preset basic temperature setpoint value or the dead zone, the heating or cooling mode is automatically activated. If the room temperature lies within the preset dead zone, neither heating nor cooling will take place (both actuating variables = "0"). The room will be cooled down if the room temperature is higher than the temperature setpoint for cooling. The room will be heated up, if the room temperature is lower than the temperature setpoint for heating.

With an automatic switch-over of the control option, the information whether the controller is in the heating mode ("1" telegram) or in the cooling mode ("0" telegram) can be actively transmitted to the bus via the *"Control option switch-over"* object 35. The *"Automatic transmission heating/cooling switch-over"* parameter determines when a control option switch-over is transmitted.

- Setting *"Changing the control option"*:

In this case, a telegram is transmitted solely when switching-over from heating to cooling (object value = "0") or from cooling to heating (object value = "1").

- Setting *"Changing the output variable"*:

With this setting, the current control option will always be transmitted if the output variable has changed. With the actuating variable = "0" the control option that was last active will be transmitted.

If the determined room temperature lies within the dead zone, the control option last activated will be retained in the object value until the controller is switched-over into the other control option.

With an automatic switch-over, the object value can also be transmitted cyclically. The *"Cyclical heating/cooling switch-over"* parameter enables cyclical transmission (factor setting > "0") and determines the cycle time.

Notes on the automatic switch-over of the control option:

A dead zone that is too narrow might result in continuous switching over between heating and cooling. For this reason the dead zone (temperature difference between the set-temperatures for heating and cooling comfort mode) should preferably not be adjusted below the default value.

- The "*Switching-over between heating and cooling*" parameter on parameter page "*Room temperature controller-functions*" is set to "via object":

Independent of the dead zone, the control option is then controlled via the "*Control option switch-over*" object 35. This type of switch-over may be required, for example, in case of heating and cooling via a single-duct system (combined heating and cooling system). For this purpose, the temperature of the medium in the single-duct system must be changed beforehand by the system control. Afterwards the control option is set via the object (often the single-duct system uses cold water for cooling during the summer, hot water for heating during the winter).

The "*Control option switch-over*" object has the following polarity: "1": heating; "0": cooling. After a reset the object value "0" and the "*Control option heating/ cooling after reset*" parameter will be activated.

The "*control option heating / cooling after reset*" parameter determines which control option will be activated after a reset. The "*heating*" or "*cooling*" setting causes the controller to activate the parameterized control option directly after the initialization phase. Setting the "*Control option before reset*" parameter will activate the control option that was selected before the reset.

If a switch-over takes place via the control option object, the controller will first switch-over into a control option that was set after the reset. The controller will switch-over, if applicable, into the other control option only after the device has received an object update.

Notes on the "*Control option before reset*" setting:

- Frequent changes of the control option in operation (e.g. several times a day) may affect the product life of the device as in this case the non-volatile storage (EEPROM) is only designed for less frequent write access.

Heating / cooling message:

Depending on the selected control option it is possible to output the information via separate objects whether heating or cooling energy is currently required, i.e. whether heating or cooling operation is in progress.

As long as the actuating variable for heating (cooling) is > "0", a "1" telegram is transmitted via the "heating" ("cooling") signalling object. The message telegrams will be reset only if the actuating variables = "0" ("0" telegram will be transmitted).

Exception: In case of a 2-state control, the LEDs "heating" or "cooling" will light up or the signalling objects for heating and cooling will already become active as soon as the temperature falls short of the temperature setpoint in case of heating or exceeds the temperature setpoint in case of cooling. In this case, the parameterized hysteresis is not being considered.

Heating and cooling at the same time is not possible!

The signalling objects may be enabled via the "*Heating message*" or the "*Cooling message*" parameter on the "*Actuating variable and status output*" parameter page.

The signalling objects are controlled by the control algorithm. It has to be considered that the actuating variable is calculated only every 30 seconds (thus updating the signalling objects every 30 seconds).

13.3 Room temperature control and actuating variables

13.3.1 Control algorithms, control circuits and calculation of actuating variable

A comfortable temperature control for a living space requires a special control algorithm which controls the installed heating or cooling systems. By considering the setpoint temperatures as well as the actual room temperature, the controller determines the actuating variables controlling the heating or cooling system. The control system (control circuit) consists of the room temperature controller, the servo drive or the switching actuator (for the use of electro-thermal drives), the actual heating or cooling element (e.g. heaters or cooling ceiling) and the room. This results in the following control process:

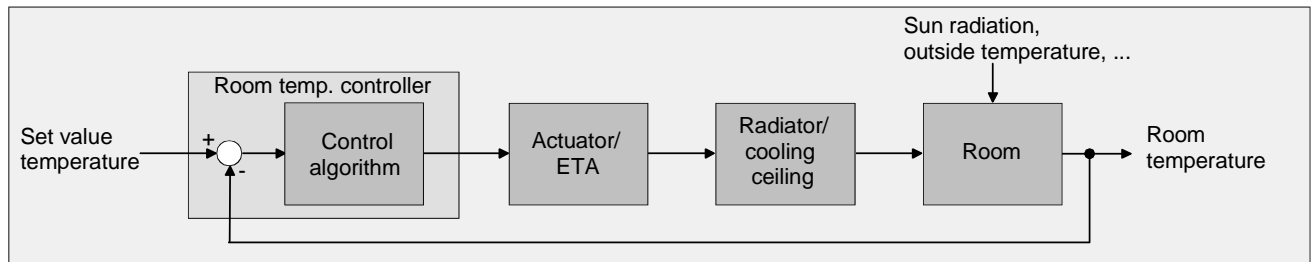

The controller measures the actual temperature (determined room temperature) and compares it with the given setpoint temperature. The control algorithm calculates the actuating variable from the difference between actual and setpoint temperature. This enables the controller to compensate for actual/setpoint temperature differences in the control circuit caused by external influences (e.g. strong exposure to sun or varying outside temperatures) by regularly readjusting the actuating variable. In addition, the flow temperature of the heating and cooling circuit affects the control process making it necessary to adapt the actuating variables.

The room temperature controller allows the option between a continuous or switching proportional/integral control (PI) or a switching 2-state control.

The actuating variables calculated by the control algorithm are output via the "actuating variable heating" or "actuating variable cooling" communication objects. The control algorithm selected for the heating and/or cooling operation determines, among other things, also the format of the actuating variable object. Thus, it is possible to create 1-bit or 1-byte actuating variable objects.

The control algorithm is determined via the "Type of heating control" or "Type of cooling control" parameters on the "Room temperature controller function" parameter page, possibly also for the additional stages.

Each of the following three algorithms can be selected:

1. Continuous PI control:

A PI control is an algorithm consisting of a proportional and an integral part. A combination of these control characteristics allows to accurately adjust the room temperature as fast as possible without or with only small control deviations.

This algorithm lets the room temperature controller calculate a new continuous actuating variable periodically every 30 seconds. This one will be output to the bus via a 1-byte value object, if the calculated actuating variable has changed by a predetermined percentage. The "Automatic transmission if value changes by..." parameter on the "Room temperature controller function – actuating variable and status output" parameter page determines the change interval in percent.

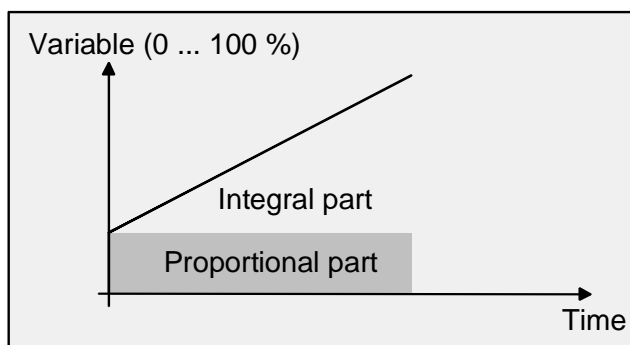

An additional PI controlled heating or cooling stage works exactly as the PI control of the basic stage. The difference is that the setpoint will shift by taking into account the parameterized stage offset.

Characteristic feature of the PI control:

If the setpoint/actual value deviation of the room temperature results in an actuating variable of 100%, the room temperature controller uses the maximum actuating variable until the determined room temperature reaches the setpoint. This special control behaviour is known as 'clipping'.

This will quickly heat up or cool down the temperature in chilled or overheated rooms. In two stage heating or cooling systems this control behaviour also applies to the actuating variables of the additional stages.

2. Switching PI control:

This parameterization will also keep the room temperature constant via the PI control algorithm. Averaged over time, the control system will behave the same as with a continuous controller. The only difference compared to a continuous control is the actuating variable output.

The actuating variable calculated periodically every 30 seconds by the algorithm is internally converted into an equivalent pulse width modulated (PWM) actuating variable signal and output to the bus via a 1-bit switching object after the cycle time.

Allowing for the cycle time which is adjustable via the "Cycle time of the switching actuating variable..." parameter on the "Room temperature controller function – actuating variable and status output" parameter page, the average value of the actuating variable signal resulting from this modulation is a measure for the averaged valve position of the control valve, thus making it a reference value for the adjusted room temperature.

Shifting of the average value and thus changing of the heating output is achieved by changing the pulse/pause ratio of the actuating variable signal.

Depending on the calculated actuating variable, the controller adapts the pulse/pause ratio only at the end of a time period! Each change in the actuating variable is realized no matter what the relative change of the actuating variable is (the "Automatic transmission if value changes by..." and "Cycle time for automatic transmission..." parameters have no function here). The actuating variable last calculated within an active time period will be realized. If the setpoint temperature changes, for example, due to switching-over into another operating mode, the actuating variable will also be adapted only at the end of an active cycle time.

The following figure shows the output actuating variable switching signal depending on the actuating variable internally calculated (first 30 %, then 50 % actuating variable; actuating variable output not inverted).

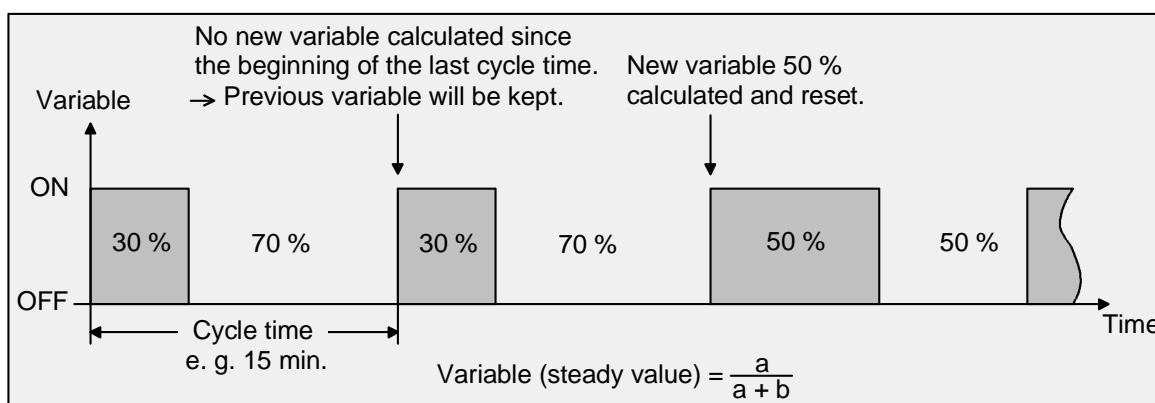

With an actuating variable of 0 % (continuously switched-off) or 100 % (continuously switched-on) an actuating variable telegram according to the actuating variable value ("0" or "1") is output after a cycle time has elapsed. With this type of control, the 'clipping' behaviour (cf. "continuous PI control") is active as well.

Even in case of a switching PI control, the controller always calculates internally with continuous actuating variable values. These continuous values can be additionally output to the bus via a separate 1-byte value object, for example, to display it as status information.

With a switching PI control (PWM), the value object 46 is created for heating and the value object 48 for cooling. If additional stages are used, the value object 47 will be additionally enabled for the additional heating and the value object 49 for the additional cooling.

If the actuating variable for heating and cooling is to be output via a shared object, the continuous value for the activated control option will be transmitted via the object 46 and, if applicable, for the additional stages via the object 47.

The status value objects are only updated after the elapse of the parameterized cycle time together with the actuating output. The "Automatic transmission if value changes by..." and "Cycle time for automatic transmission..." parameters have no function here.

An additional PI controlled heating or cooling stage works exactly the same as the switching PI control of the basic stage. The difference is that the setpoint will shift by taking into account the parameterized stage offset. All PWM controls use the same cycle time.

Cycle time:

In most cases, the pulse width modulated actuating variables are used to control electro-thermal drives. The room temperature controller transmits the switching actuating variable telegrams to a switching actuator (preferably with semi-conductor switching elements) which is connected to the drives.

Setting the cycle time for the PWM signal allows to adapt the control to the drives that are being used. The cycle time determines the switching frequency of the pulse modulated signal and allows the adaptation to the adjusting cycle times of the servo drive (time required by the drive to adjust the valve from a completely closed position to a completely opened position). In addition to the adjusting cycle time, the dead time (time during which the servo drives show no response when switching on or off) has to be considered. If different drives with different adjusting cycle times are used, the longer time is to be accounted for. The manufacturer's specifications for the drive have to be observed.

In standard practice, two cases for the adjustment of the cycle time can be considered:

I. Cycle time 2 x adjusting cycle time of the drives being used, for example 15 minutes (default)

In this case, the pulse/pause times of the PWM signal are long enough for the drives to completely open or close within a time period.

Advantages:

The desired average value for the actuating variable and thus the required room temperature is relatively accurately adjusted even with several drives that are simultaneously activated.

Disadvantages:

It has to be considered that due to the constantly 'travelled' full valve lift the product life of the drives may decrease. The heat transfer to the room in the vicinity of the heater may be non-uniform and may be felt bothering to some people if the cycle times are very long (> 15 minutes) and if the system has a slower response (for example in case of smaller hot water heaters).

Notes:

- This setting for the cycle time is recommended for slower, more inert heating systems (for example underfloor heating).
- This setting is also recommended for a larger number of possibly different drives making it easier to average the valve travel.

II. Cycle time < adjusting cycle time of the drives being used, for example 2 minutes (default)

In this case, the short pulse/pause times of the PWM signal are not sufficient for the drives to completely open or close within a time period.

Advantages:

This setting ensures a constant water flow through the heaters with a uniform heat transfer to the room. If only one servo drive is controlled, the controller is able to compensate for the shift of the average value caused by the short cycle time by continuously adapting the actuating variable and is thus able to adjust the desired room temperature.

Disadvantages:

If more than one drive is controlled at the same time, the desired average for the actuating variable and thus the required room temperature is adjusted only very poorly or with larger deviations.

Note:

- This setting for the cycle time is recommended for fast-responding heating systems (for example hot water heaters with higher flow temperature).

3. Switching 2-state control:

The 2-state control represents a very simple temperature control. For this type of control, two hysteresis temperature values are predefined. The controller addresses the actuating elements via switch-on and switch-off actuating variable commands (1-bit). A continuous actuating variable will not be calculated with this type of control. The room temperature is evaluated periodically every 30 seconds as well, i.e. the actuating variables, if required, will change only during these times.

While the 2-state temperature control is very simple, the fluctuating temperature is a disadvantage. For this reason, no fast responding heating or cooling systems should be controlled via a 2-state control as it may result in heavy temperature overshooting and thus in a loss of comfort.

When defining the hysteresis limit settings, one has to distinguish between the control options:

- Individual control options *"heating"* or *"cooling"*:

In the heating mode the controller will switch-on the heater, if the temperature falls below a preset limit. In the heating mode the controller will switch-off the heater only, if an adjusted temperature limit has been exceeded.

In the cooling mode the controller will switch-on the cooling, if the room temperature has exceeded a preset limit. While in the cooling mode, the controller will switch-off the cooling only if the temperature has fallen below an adjusted temperature limit.

Depending on the switching state of the actuating variable, a "1" or "0" will be output, if the value exceeds or remains under the hysteresis limits.

In case of a 2-state control, the LEDs *"heating"* or *"cooling"* will light up or the signalling objects for heating and cooling will already become active as soon as the temperature falls short of the temperature setpoint in case of heating or exceeds the temperature setpoint in case of cooling. In this case, the hysteresis is not taken into account.

The upper and lower hysteresis limits are to be parameterized in the ETS for both control options.

The following figure shows a 2-state control for the individual control options *"heating"* or *"cooling"* (heating on the left, cooling on the right; two temperature setpoints; one-stage heating or cooling; non-inverted actuating variable output):

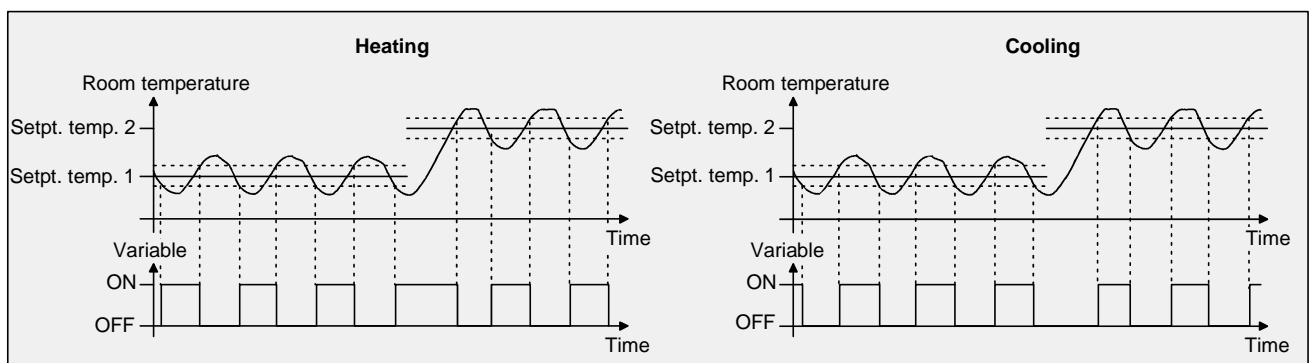

An additional 2-state control heating or cooling stage works in exactly the same way as the 2-state control of the basic stage. The difference is that the setpoint and the hysteresis values will shift by taking into account the parameterized stage offset.

- "Heating" and "cooling" mixed mode:

In the heating mode the controller will switch-on the heater, if the temperature falls below a preset limit. The control will switch-off the heater as soon as the room temperature exceeds the temperature setpoint of the active operating mode.

In the cooling mode the controller will switch on the cooling, if the room temperature has exceeded a preset limit. While in the cooling mode the controller will switch off the cooling as soon as the room temperature falls below the temperature setpoint of the active operating mode.

Thus, in mixed-mode operation there is no upper hysteresis limit value for heating or no lower hysteresis limit value for cooling as these values would lie in the dead zone. There is neither heating nor cooling within the dead zone.

Depending on the switching state the actuating variable "1" or "0" will be output, if the values exceed or remain under the hysteresis limits.

In case of a 2-state control, the LEDs "heating" or "cooling" will light up or the signalling objects for heating and cooling will already become active as soon as the temperature falls short of the temperature setpoint in case of heating or exceeds the temperature setpoint in case of cooling. In this case, the hysteresis is not taken into account.

The upper and lower hysteresis limits are to be parameterized in the ETS for both control options.

The following figure shows a 2-state control for the "heating" or "cooling" mixed-mode (activated heating on the left, activated cooling on the right; two temperature setpoints; non-inverted actuating variable output):

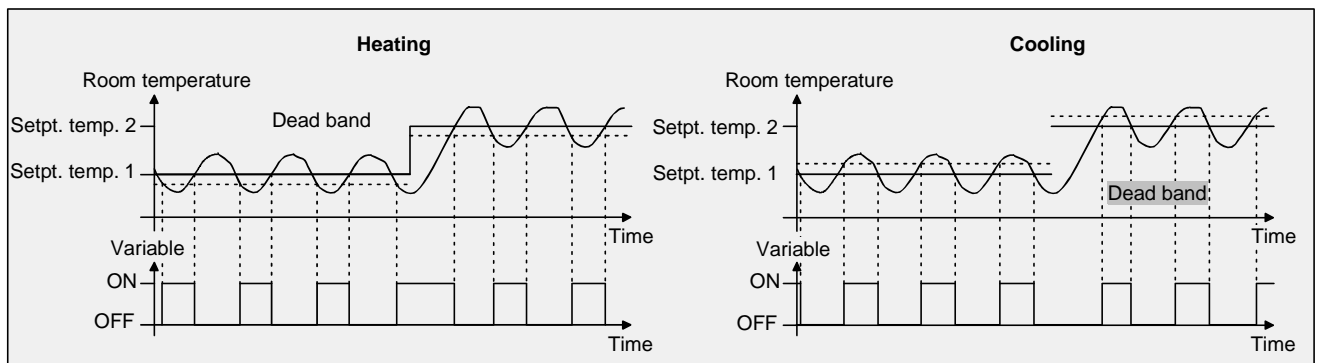

An additional 2-state control heating or cooling stage works in exactly the same way as the 2-state control of the basic stage. The difference is that the setpoint and the hysteresis values will shift by taking into account the parameterized stage offset.

13.3.1.1 Adapting the PI control

There are several systems available which may heat or cool a room. Thus, it is possible to uniformly heat or cool the surroundings with heat transfer media (preferably water or oil) in combination with room air convection. Such systems are used, for example, with wall mounted heaters, underfloor heating or cooling ceilings. Alternatively, rooms can be heated or cooled by blower units. In most cases, such systems are electrical fan heaters, fan coolers or refrigerating compressors with fans. Due to the direct heating of the room air, such heating and cooling systems work quite fast.

The control parameters need to be adjusted so that the PI control algorithm may efficiently control all common heating and cooling systems thus making the room temperature control work as fast as possible and without deviation.

Certain factors can be adjusted in a PI control system that can influence the control behaviour quite significantly at times. For this reason, the room temperature controller can be set to predefined 'experience values' for the most common heating and cooling systems. In case the selection of a corresponding heating or cooling system does not yield a satisfactory result with the default values, the adaptation can optionally be optimized via control parameters.

Predefined control parameters for the heating or cooling stage and, if applicable, also for the additional stages are adjusted via the *Type of heating* or *Type of cooling* parameters. These fixed values correspond to the practical values of a properly planned and executed air conditioning system and will result in an ideal behaviour of the temperature control. The following types can be set for heating or cooling.

for heating control				
Type of heating	default values		recommended type of PI control:	recommended PWM cycle time
	Proportional range	Reset-time		
• Hot water heating	5 Kelvin	150 minutes	continuous / PWM	15 minutes **
• Underfloor heating	5 Kelvin	240 minutes	PWM	15 – 20 min.
• Electrical heating	4 Kelvin	100 minutes	PWM	10 – 15 min.
• Blower convector	4 Kelvin	90 minutes	continuous	---
• Split-unit *	4 Kelvin	90 minutes	PWM	10 – 15 min.
for cooling control				
Type of cooling	default values		recommended type of PI control:	recommended PWM cycle time
	Proportional range	Reset-time		
• Cooling ceiling	5 Kelvin	240 minutes	PWM	15 – 20 min.
• Blower convector	4 Kelvin	90 minutes	continuous	---
• Split-unit *	4 Kelvin	90 minutes	PWM	10 – 15 min.

*: split mobile climate control unit,

** : for smaller, fast-working heaters (e.g. higher flow temperature) PWM cycle time 2 – 3 minutes.

If the "Type of heating" or "Type of cooling" parameters are set to "via control parameters" it will be possible to adjust the control parameters manually. The control may be considerably influenced by presetting the proportional range for heating or for cooling (P component) and the reset-time for heating or for cooling (I component).

Notes:

- Even minor adjustments of the control parameters will lead to a noticeably different control behaviour.
- The adaptation should start with the control parameter setting for the corresponding heating or cooling system according to the fixed values mentioned above.

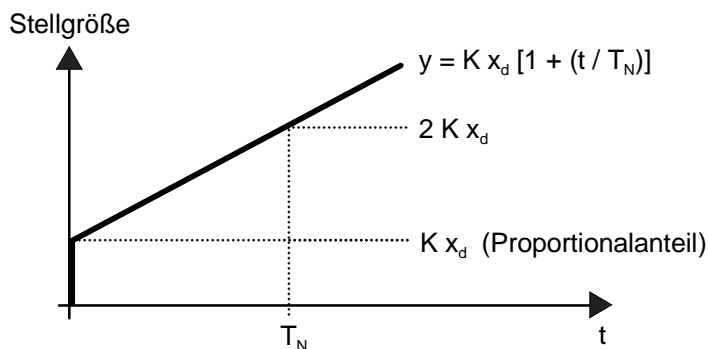

x_d : Regeldifferenz $x_d = x_{soll} - x_{ist}$
 $P = 1/K$: parametrierbarer Proportionalbereich
 $K = 1/P$: Verstärkungsfaktor
 T_N : parametrierbare Nachstellzeit

PI control algorithm: Actuating variable $y = K x_d [1 + (t / T_N)]$; By deactivating the reset-time (setting = "0"):

P control algorithm: Actuating variable $y = K x_d$

Parameter setting		Result
P	small proportional range	large overshoot in case of setpoint changes (possibly permanently), quick adjustment to the setpoint
P	large proportional range	no (or small) overshoot but slow adjustment
T_N	short reset-time	fast compensation of control deviations (ambient conditions), risk of permanent oscillations
T_N	long reset-time	slow compensation of control deviations

13.3.1.2 Adapting the 2-state control

The 2-state control is a very simple temperature control system. For this type of control, two hysteresis temperature values are predefined.

The upper and lower temperature hysteresis limits can be adjusted via parameters. It has to be considered that...:

- a small Hysteresis will lead to small temperature variations but to a higher bus load.
- a large hysteresis switches less frequently but will cause uncomfortable temperature variations.

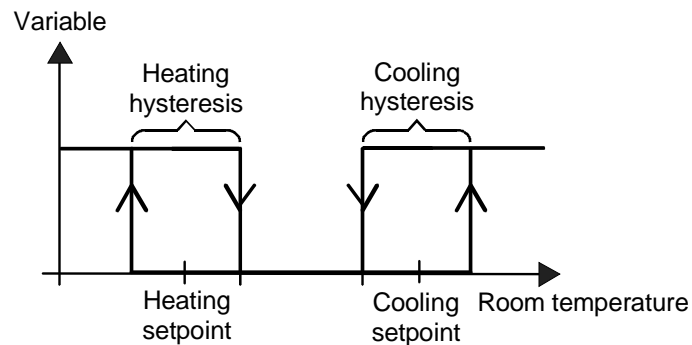
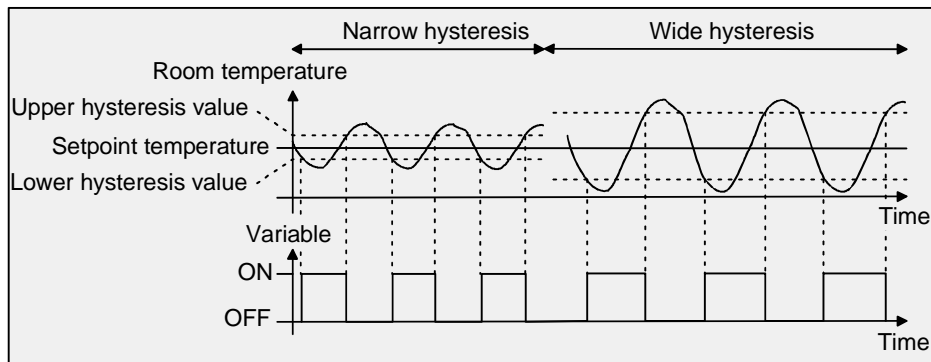

13.3.2 Actuating variable output

13.3.2.1 Actuating variable objects

The format of the actuating variable objects is determined depending on the control algorithm selected for heating and / or cooling and, if applicable, also for the additional stages. 1-bit or 1-byte actuating variable objects can be created. The control algorithm calculates and outputs the actuating variables in intervals of 30 seconds. With the pulse-width modulated PI control (PWM), the actuating variable is updated, if required, only at the end of a time cycle.

Possible object data formats for the actuating variables separately for both control options, for the basic and the additional stage, are...

- continuous PI control: 1 byte
- switching PI control: 1 bit + additionally 1 byte (e.g. for status indication in visualization systems),
- switching 2-state control: 1 bit.

Depending on the selected control option, the controller is able to address heating and / or cooling systems, to determine actuating variables and to output them via separate objects. One distinguishes between two cases for the mixed mode "*heating and cooling*":

Case 1: Heating and cooling system are two separate systems.

In this case, the "*Transmit actuating variable heating and cooling to a shared object*" parameter should be set to "*no*" (default) on the "*Room temperature controller functions*" parameter page. Thus there are separate objects available for each actuating variable which can be separately addressed via the individual systems. This setting allows to define separate types of control for heating and cooling.

Case 2: Heating and cooling system are a combined system.

In this case the "*Transmit actuating variable heating and cooling to a shared object*" parameter may be set, if required, to "*yes*" on the "*Room temperature controller functions*" parameter page. This will transmit the actuating variables for heating and cooling to the same object. In case of a 2-stage control, another shared object will be enabled for the additional stages for heating and cooling.

With this setting it is only possible to define the same type of control for heating and for cooling as the control and the data format must be identical. The ("*Type of heating / cooling*") control parameter for cooling and heating still have to be defined separately.

A combined actuating variable object may be required, for example, if heating as well as cooling shall take place via a single-duct system (combined heating and cooling system). For this purpose, the temperature of the medium in the single-duct system must be changed beforehand by the system control. Afterwards the control option is set via the object (often the single-duct system uses cold water for cooling during the summer, hot water for heating during the winter).

Note:

Basically, it is not possible to heat and cool at the same time (actuating variables > "0")!

13.4 Temperature setpoints

13.4.1 Setpoint presettings in the ETS

Temperature setpoints can be preset independently for each operating mode. The setpoints for the "comfort", "standby" und "night" modes can be parameterized in the ETS. If desired, the setpoint temperatures can be subsequently adjusted via local operation of the controller in the programming mode or via object control. The "frost/heat protection" operating mode allows the separate parameterization of two temperature setpoints for heating (frost protection) and cooling (heat protection) only in the ETS.

When presetting the setpoint temperatures for comfort, standby and night mode, attention has to be paid to the fact that all setpoints depend on each other as all values are derived from the basic temperature (basic setpoint). The "*Basic temperature after reset*" parameter on the "*Setpoints*" parameter page determines the basic setpoint which is loaded when the device is programmed with the ETS.

Taking into account the "*Decreasing /increasing the setpoint temperature in standby mode*" or "*Decreasing/ increasing the setpoint temperature in night mode*" parameters, the temperature setpoints for the standby and night mode are derived from this value depending on the heating or cooling control option. The dead zone will be additionally considered for the "*Heating and cooling*" mode.

In the 2-stage control mode, all setpoint temperatures of the additional stage are derived from the setpoint temperatures of the basic stage. The setpoint temperatures of the additional stage are determined by subtracting the "*stage offset*", which is parameterized in the ETS from the setpoints of the basic stage in heating mode or by adding the setpoints in cooling mode. If the temperature setpoints of the basic stage are changed by setting a new basic setpoint, the setpoint temperatures of the additional stage will be indirectly and automatically changed as well. Both stages will heat or cool with the same actuating variable at the same time when the setpoint difference is "0".

Depending on the control option, the relationships described on the following pages have to be considered for the setpoint temperatures.

13.4.1.1 Setpoints for the "heating" option

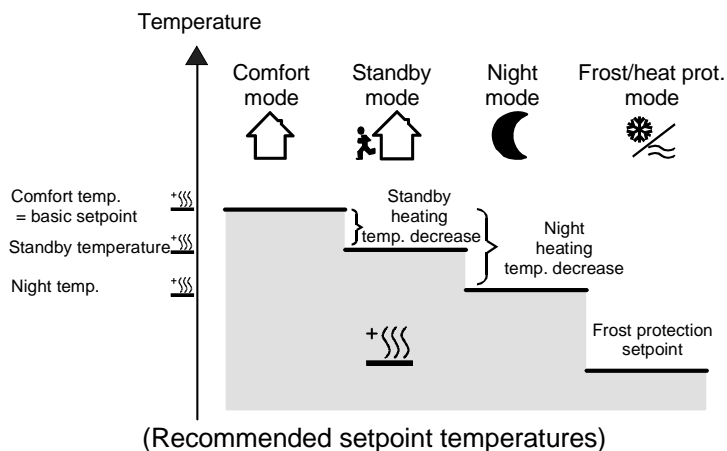

The setpoint temperatures for comfort, standby and night mode exist for this control option. The frost protection temperature can be preset. The following applies...

$$T_{\text{standby setpoint heating}} \leq T_{\text{comfort setpoint heating}} \text{ OR } T_{\text{night setpoint heating}} \leq T_{\text{comfort setpoint heating}}$$

The standby and night setpoint temperatures are derived from the comfort setpoint temperature (basic setpoint) in line with the parameterized decrease-temperatures. If enabled, it is also possible to adjust also other reduction temperatures by means of a local operation on the controller itself in the programming mode by changing the setpoint temperature values for night and standby mode.

The frost protection is supposed to prevent the heating system from freezing. For this reason the frost protection temperature should be set to a smaller value than the night temperature for heating (default: +7 °C). In principle, however, it is possible to select frost protection temperature values between +7 °C and +40 °C.

The possible range of values for a setpoint temperature lies between + 7.0 °C and + 99.9 °C for "heating" and is limited by the frost protection temperature in the lower range.

The stage offset parameterized in the ETS will be additionally considered in a two stage heating mode.

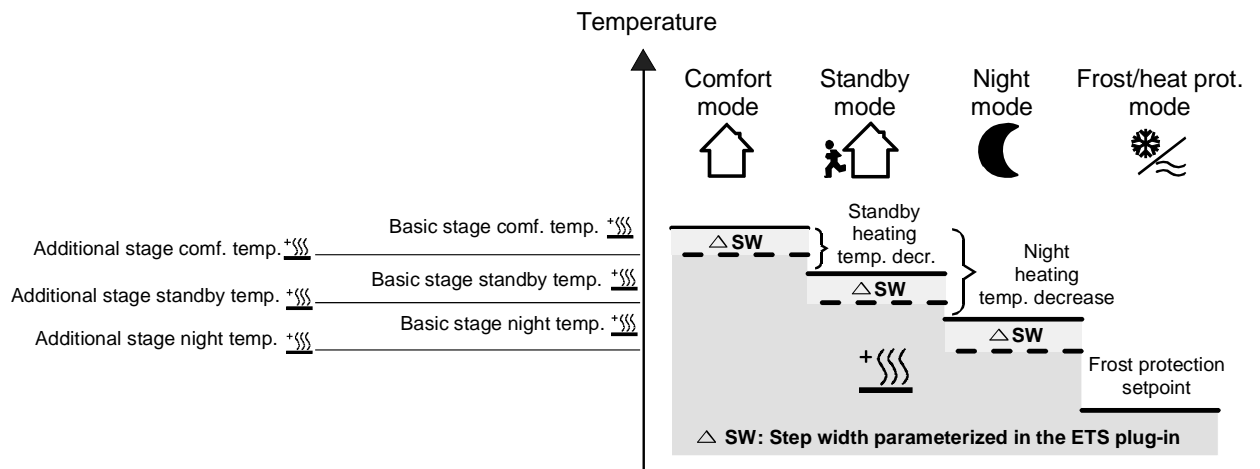

$$T_{\text{comfort setpoint additional stage heating}} \leq T_{\text{comfort setpoint basic stage heating}} / T_{\text{standby setpoint additional stage heating}} \leq T_{\text{standby setpoint basic stage heating}}$$

$$T_{\text{standby setpoint heating}} \leq T_{\text{comfort setpoint heating}}$$

or

$$T_{\text{comfort setpoint additional stage heating}} \leq T_{\text{comfort setpoint basic stage heating}} / T_{\text{night setpoint additional stage heating}} \leq T_{\text{night setpoint basic stage heating}}$$

$$T_{\text{night setpoint value heating}} \leq T_{\text{comfort setpoint heating}}$$

13.4.1.2 Setpoints for the "cooling" option

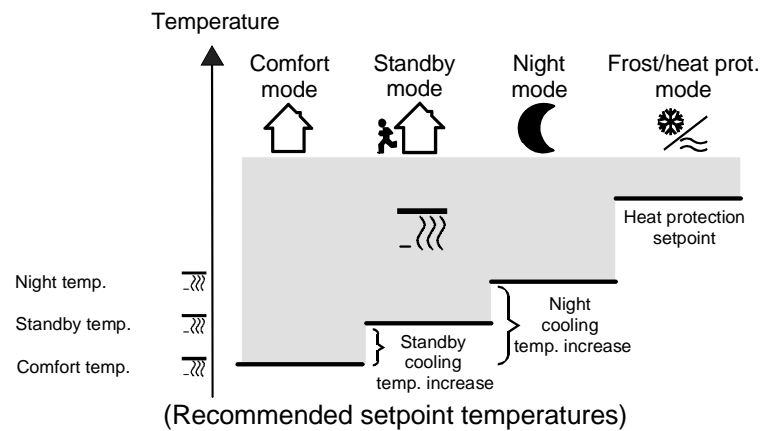

The setpoint temperatures for comfort, standby and night mode exist for this control option. The heat protection temperature can be preset. The following applies...

$$T_{\text{comfort setpoint value cooling}} \leq T_{\text{standby setpoint cooling}} \text{ or } T_{\text{comfort setpoint cooling}} \leq T_{\text{night setpoint cooling}}$$

The standby and night setpoint temperatures are derived from the comfort setpoint temperature (basic setpoint) in line with the parameterized increase temperatures.

The heat protection is supposed to ensure that the maximum permissible room temperature is not exceeded in order to protect system components. For this reason the heat protection temperature should be set to a larger value than the night temperature (default: +35 °C). In principle, however, it is possible to select heat protection temperature values between +7 °C and +45 °C.

The possible range of values for a set-temperature lies between - 99.9 °C and + 45.0 °C for "cooling" and is limited by the heat protection temperature in the upper range.

The stage offset parameterized in the ETS will be additionally considered in a two stage heating mode.

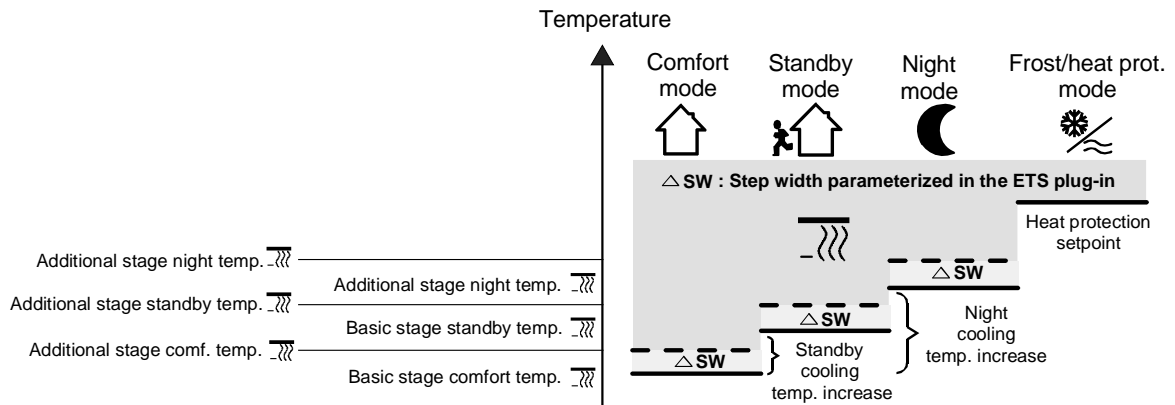

$$T_{\text{comfort setpoint basic stage cooling}} \leq T_{\text{comfort setpoint additional stage cooling}} / T_{\text{standby setpoint basic stage cooling}} \leq T_{\text{standby setpoint additional stage cooling}}$$

$$T_{\text{comfort setpoint cooling}} \leq T_{\text{standby setpoint cooling}}$$

or

$$T_{\text{comfort setpoint basic stage cooling}} \leq T_{\text{comfort setpoint additional stage cooling}} / T_{\text{night setpoint basic stage cooling}} \leq T_{\text{night setpoint additional stage cooling}}$$

$$T_{\text{comfort setpoint cooling}} \leq T_{\text{night setpoint cooling}}$$

13.4.1.3 Setpoint for the "heating and cooling" option

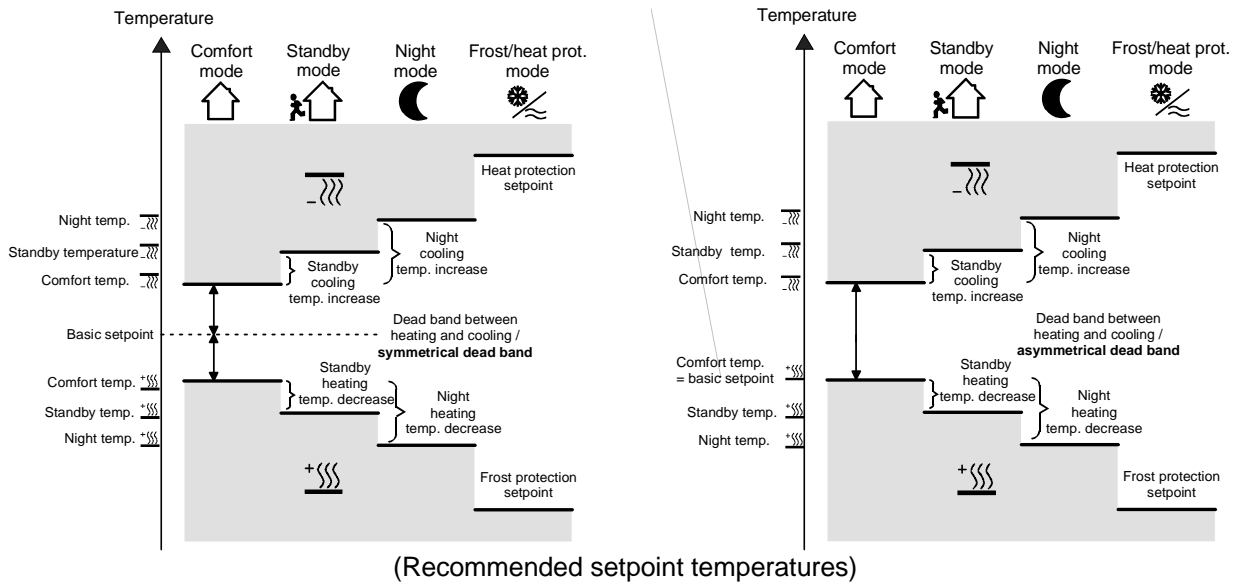

For this control option, the setpoint temperatures of both control options exist for comfort, standby and night mode as well as the dead zone. In addition, the frost protection and the heat protection temperatures can be preset. The following applies...

$$T_{\text{standby setpoint heating}} \leq T_{\text{comfort setpoint heating}} \leq T_{\text{comfort setpoint cooling}} \leq T_{\text{standby setpoint cooling}}$$

or

$$T_{\text{night setpoint heating}} \leq T_{\text{comfort setpoint heating}} \leq T_{\text{comfort setpoint cooling}} \leq T_{\text{night setpoint cooling}}$$

The setpoint temperatures for "Standby" and "Night" are derived from the comfort setpoint temperatures for heating or cooling. The temperature increase (for cooling) and the temperature decrease (for heating) of both operating modes can be preset in the ETS. The comfort temperatures themselves are derived from the dead zone and the basic setpoint.

The frost protection is supposed to prevent the heating system from freezing. For this reason the frost protection temperature should be to a set smaller value than the night temperature for heating (default: +7 °C). In principle, however, it is possible to select frost protection temperature values between +7 °C and +40 °C.

The heat protection is supposed to prevent the temperature from exceeding the maximum permissible room temperature in order to protect system components. For this reason the heat protection temperature should be set to a larger value than the night temperature for cooling (default: +35 °C). In principle, however, it is possible to select heat protection temperature values between +7 °C and +45 °C.

The possible range of values for a setpoint temperature ("heating and cooling") lies between + 7 °C and + 45.0 °C and is limited by the frost protection temperature in the lower range and by the heat protection temperature in the upper range..

The stage offset parameterized in the ETS will be additionally considered in a 2-stage heating or cooling mode.

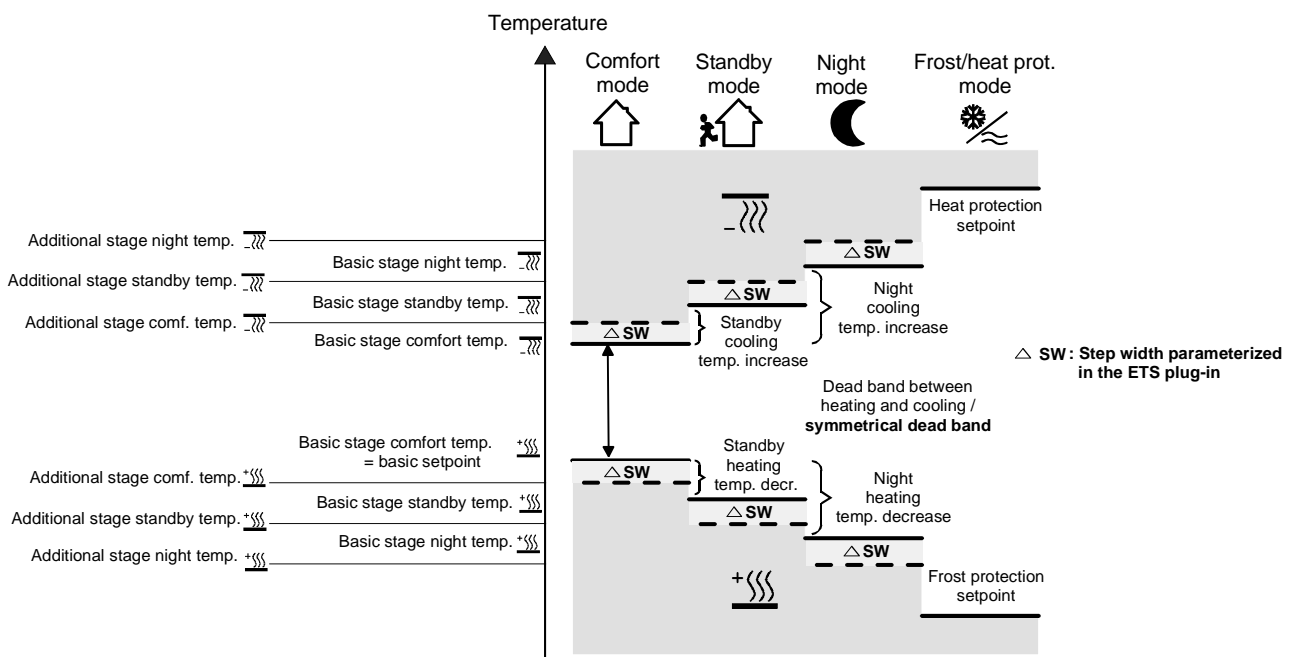

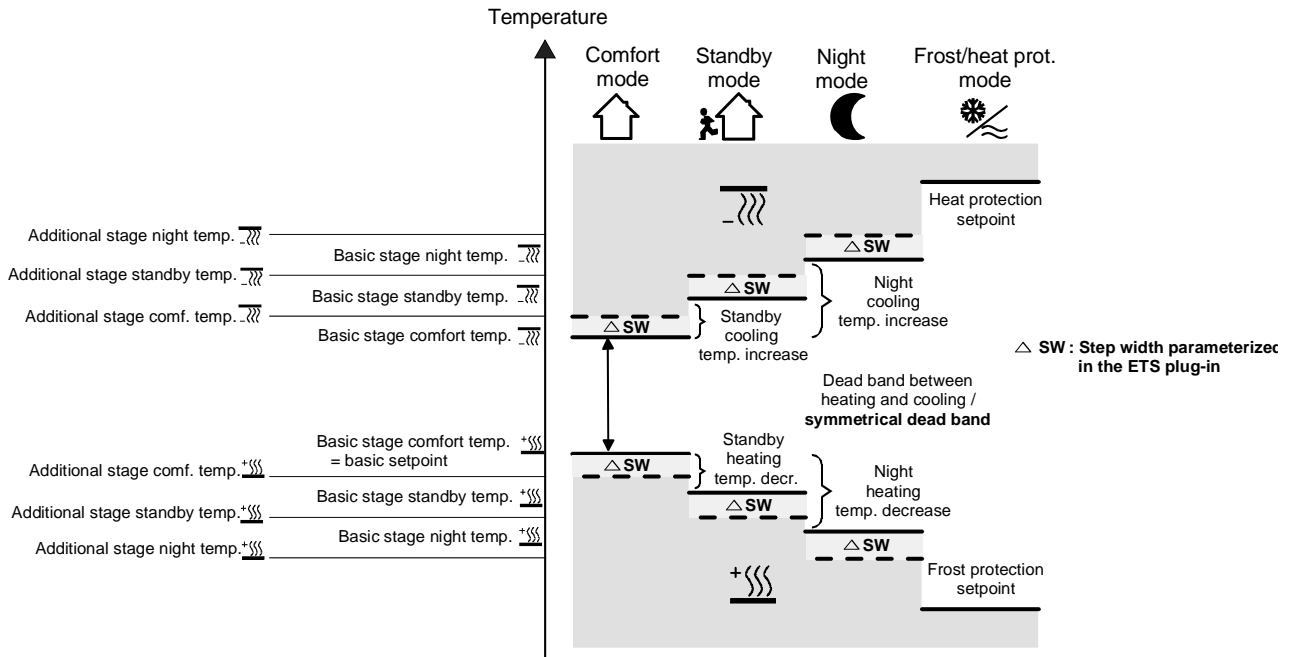

$$T_{\text{comfort setpoint additional stage heating}} \leq T_{\text{comfort setpoint basic stage heating}} \leq T_{\text{comfort setpoint basic stage cooling}} \leq T_{\text{comfort setpoint additional stage cooling}}$$

$$T_{\text{standby setpoint additional stage heating}} \leq T_{\text{standby setpoint basic stage heating}} \leq T_{\text{standby setpoint basic stage cooling}} \leq T_{\text{standby setpoint additional stage cooling}}$$

$$T_{\text{standby setpoint heating}} \leq T_{\text{comfort setpoint heating}} \leq T_{\text{comfort setpoint cooling}} \leq T_{\text{standby setpoint cooling}}$$

or

$$T_{\text{comfort setpoint additional stage heating}} \leq T_{\text{comfort setpoint basic stage heating}} \leq T_{\text{comfort setpoint basic stage cooling}} \leq T_{\text{comfort setpoint additional stage cooling}}$$

$$T_{\text{night setpoint additional stage heating}} \leq T_{\text{night setpoint basic stage heating}} \leq T_{\text{night setpoint basic stage cooling}} \leq T_{\text{night setpoint additional stage cooling}}$$

$$T_{\text{night setpoint heating}} \leq T_{\text{comfort setpoint heating}} \leq T_{\text{comfort setpoint cooling}} \leq T_{\text{night setpoint cooling}}$$

Dead zone:

The comfort setpoint temperatures for heating and cooling are derived from the basic setpoint in consideration of the adjusted dead zone. The dead zone (temperature zone for which there is neither heating nor cooling) is the difference between the comfort setpoint temperatures.

The "Dead zone between heating and cooling", "Dead zone position" parameters as well as the "Basic temperature after reset" parameter are preset in the ETS. The following settings must be distinguished:

Dead zone = "symmetrical" (default):

The dead zone preset in the ETS is divided into two parts at the basic setpoint. The comfort setpoint temperatures are derived directly from the basic setpoint resulting from the half dead zone. The following applies:

$$T_{\text{basic setpoint}} - \frac{1}{2}T_{\text{dead zone}} = T_{\text{comfort setpoint heating}} \text{ Or } T_{\text{basic setpoint}} + \frac{1}{2}T_{\text{dead zone}} = T_{\text{comfort setpoint cooling}}$$

$$\rightarrow T_{\text{comfort setpoint cooling}} - T_{\text{comfort setpoint heating}} = T_{\text{dead zone}}; T_{\text{comfort setpoint cooling}} \geq T_{\text{comfort setpoint heating}}$$

Dead zone position = "asymmetrical":

With this setting, the comfort setpoint temperature for heating equals the basic setpoint! The dead zone preset in the ETS takes only effect from the basic setpoint in the direction of comfort temperature for cooling. Thus the comfort setpoint temperature for cooling is derived directly from the comfort setpoint for heating. The following applies:

$$T_{\text{basic setpoint}} = T_{\text{comfort setpoint heating}} \rightarrow T_{\text{basic setpoint}} + T_{\text{dead zone}} = T_{\text{comfort setpoint cooling}}$$

$$\rightarrow T_{\text{comfort setpoint cooling}} - T_{\text{comfort setpoint heating}} = T_{\text{dead zone}}; T_{\text{comfort setpoint cooling}} \geq T_{\text{comfort setpoint heating}}$$

13.4.1.4 Limiting the setpoint temperatures in cooling operation

According to the place-of-work regulations, DIN 1946 Part 2 and the industrial premises tenancy laws, the maximum temperature at the place of work must not exceed 26°C and – in case of outside temperatures above 32°C – be at least 6K lower than respective temperature. The value may be exceeded only in exceptional cases. To cope with these guidelines, the room controller has four parameters which apply only to cooling operation.

The parameter "Setpoint temperature limiting during cooling operation" can be used to deactivate the limiting function or to specify the limiting procedure.

In the setting "Difference with respect to outside temperature" a maximum difference between 1 and 15 K can be specified. When the outside temperature rises to such an extent that the maximum difference is exceeded, the controller corrects the setpoint temperature value until the desired difference is again reached. The setpoint temperature is raised only temporarily. When the outside temperature drops again, the setpoint temperature is reduced as well until the original setpoint temperature is again reached.

In the setting "Max. setpoint temperature only", all setpoint temperatures higher than the configured value (default: 26°C) are not accepted. This applies also to the user inside the room who cannot set a higher value by setpoint shifting. The parameterized "heat protection" setpoint cannot be exceeded either.

In the setting "Max. setpoint temperature and difference with respect to outside temperature", the maximum setpoint temperature has the priority. This means that the controller can correct the setpoint temperature based on the difference with respect to the outside temperature until the maximum setpoint temperature is exceeded.

13.4.2 Adjusting the setpoints

13.4.2.1 Adjusting basic temperature and setpoint temperatures for comfort, standby and night mode

When presetting the setpoint temperatures for comfort, standby and night mode, attention has to be paid to the fact that all setpoints depend on each other as all values are derived from the basic temperature (basic setpoint). The "*Basic temperature after reset*" parameter on the "*Setpoints*" parameter page determines the basic setpoint which is loaded when the device is programmed with the ETS.

It is possible to change or adjust the setpoint temperatures 'later' via the "*Basic setpoint*" object).

Any change must always be enabled in the ETS on the "*Setpoints*" parameter page. It is possible to permit the "*Change of basic temperature setpoint*" by directly changing the comfort temperature for heating on the device and/or by presetting a new basic setpoint via the bus.

In case basic setpoint adjustment via the bus is disabled, the object "*Basic setpoint*" will be hidden.

Adjusting the basic setpoint / comfort temperature for heating:

It is only in the event of a basic setpoint change that two cases must be distinguished:

- Case 1: The basic setpoint change is permanently adopted,
- Case 2: The basic setpoint change is adopted only temporarily (default).

Via the "*Adopt basic temperature setpoint change permanently*" parameter on the "*Room temperature controller function /setpoints*" parameter page, it is possible to determine whether the changed basic temperature value shall be stored in memory permanently ("*yes*") or only temporarily ("*no*").

Case 1:

If the basic temperature setpoint is changed, it will be permanently stored in the room temperature controller's EEPROM. The newly adjusted value will overwrite the basic setpoint temperature originally parameterized in the ETS! This is the only way to keep the changed basic setpoint even after switching over the operating mode or after a reset.

Notes:

- Frequent adjustments of the basic temperature (e.g. several times a day) can affect the product life of the device as the non-volatile storage (EEPROM) is designed only for less frequent write access.
- Any value preset via local control will not be adopted by the "Basic setpoint" object.
- The stored basic setpoint will still be active after the return of bus voltage. The value of the object is, however, "0". The current basic setpoint can be read out only after an external object update (set "R" flag!).

Case 2:

The basic setpoint adjusted on the room temperature controller itself or received via the object stays only temporarily active in the current operating mode. In case of a bus voltage failure or following a switch-over into another operating mode (e.g. comfort followed by standby), the basic setpoint adjusted via local operation or received via the object will be discarded and replaced by the value which was originally parameterized in the ETS.

Adjusting the setpoints for standby mode, night mode and dead zone (comfort temperature for cooling):

Since the setpoint temperatures for the "standby" and "night" operating modes or the setpoints for the "cooling" control option are derived - in consideration of the increase, decrease or dead zone values that are parameterized in the ETS or preset locally - from the basic setpoint temperature, these setpoint temperatures will shift linearly by the change of the basic setpoint value.

In addition, it is possible to adjust setpoint temperatures other than those parameterized in the ETS for "standby", "night" or "dead zone" only via local control in the programming mode. In this case, the originally parameterized decrease, increase temperatures or dead zone temperatures will be replaced by the new values resulting from the locally adjusted temperature setpoints. Independent of the "*Adopt basic temperature setpoint change permanently*" parameter, the temperature setpoints for the standby or night mode or "cooling" comfort mode (dead zone) will always be stored in the non-volatile EEPROM memory.

13.4.2.2 Basic setpoint shifting

In addition to the setting of individual temperature setpoints by the ETS, by local operation in the programming mode or by the basic setpoint object, the user is able to shift the basic setpoint anytime with the "setpoint shift" key function (if parameterized) within the parameterized limits.

It has to be considered that a shift of the displayed setpoint temperature (temperature offset of the basic temperature) will directly affect the basic setpoint and as a result shift all other temperature setpoints.

Whether a basic setpoint shift only affects the currently active operating mode or whether it influences all other setpoint temperatures of the remaining operating modes is determined by the *"Adopt change of basic setpoint shift permanently"* parameter on the *"Setpoint"* parameter page.

Settings: "no" (default):

Shifting of the basic setpoint is effective only as long as the operating mode or control option is not changed or the basic setpoint is maintained. Otherwise the setpoint shift will be reset to "0".

Setting "yes":

In general, shifting of the basic setpoint affects all operating modes. The shift is maintained even after switching-over the operating mode or the control option or after readjusting the basic setpoint.

The adjustable temperature range for a basic setpoint shift is defined via the *"Adjusting the basic setpoint temperature upwards"* or *"Adjusting the basic setpoint temperature downwards"* parameters. It is possible to shift the current setpoint by a maximum of +/- 10 K. The stage offset is set invariably to 0.5 °C.

Notes on basic setpoint shifting:

- Since the value for the basic setpoint shifting is stored exclusively in volatile memory (RAM), the shift will get lost in case of a reset (e.g. bus voltage failure).
- A setpoint shift does not affect the temperature setpoints for frost or heat protection.

Communication objects for the basic setpoint shifting:

The controller carries the current setpoint shift in the "*Current setpoint shifting*" communication object with a 6.010-byte counting value (acc. to KNX DPT – representation of positive and negative values in a 2's complement). By connecting to this object the controller extensions are also able to display the current setpoint shift.

As soon as there is an adjustment by one temperature step (0.5 °C) in positive direction, the controller counts up the value by one digit. The counting value will be counted down by one digit, if there is a negative adjustment of the temperature.

Thus the possible range of values for the object is determined by the setpoint adjustment options. A value of "0" means that no setpoint shift has been adjusted.

Example:

Initial situation:

The temperature step for the setpoint shift is set to 0.5 °K.

Current setpoint temperature = 21.0°C / counting value in object 52 = "0" (no setpoint shift active)

After shifting the setpoint:

- A setpoint shift by one temperature step in positive direction will count up the value in object 52 by one = "1". Current setpoint temperature = 21.5°C.
- Another setpoint shift by one temperature step in positive direction will count up the value in object 52 again by one = "2". Current setpoint temperature = 22.0°C.
- A setpoint shift by one temperature step in negative direction will count down the value in object 52 by one = "1". Current setpoint temperature = 21.5°C.
- Another setpoint shift by one temperature step in negative direction will count down the value in object 52 again by one = "0". Current setpoint temperature = 21.0°C.
- Another setpoint shift by one temperature step in negative direction will count down the value in object 52 again by one = "-1". Current setpoint temperature = 20.5°C.

etc.

The maximum possible range of values for the "*Current setpoint shift*" communication object depends on the "*Adjustment options of the basic setpoint temperature upwards/downwards*" parameter. A parameterization of ± 10 K at this point will have the value of the object move within the limits $-20 \dots +20$.

In addition, the setpoint shift of the controller can be externally adjusted via communication object 53 ("*Setpoint shift preset*"). This object has the same datapoint type and range of values as object 52 (see above). A connection with object 53, enables the controller extensions to directly adjust the current setpoint shift of the controller.

As soon as the controller receives a value, it will adjust the setpoint shift accordingly. Each value increment corresponds to a temperature step of 0.5°C (cf. example above). Values that lie within the possible range of values can be approached directly.

The controller monitors the received value independently. As soon as the external preset value exceeds the limits of the adjustment options for the setpoint shifting in positive or negative direction, the controller will correct the received value and adjust the setpoint shifting to maximum. Depending on the direction of the shift, the value feedback is set to the maximum value via communication object 52 ("*Current setpoint shift*").

13.4.2.3 Transmitting the setpoint temperature

The setpoint temperature determined by the current operating mode or subsequently readjusted can be transmitted actively to the bus by means of object 50 "*Setpoint temperature*".

The "*Transmission when setpoint temperature changes by...*" parameter on the "*Setpoints*" parameter page determines the temperature value by which the setpoint has to change in order to have the setpoint temperature value transmitted automatically via the object. Temperature value changes between 0.1 C and 25.5°C or 0.1 K and 25.5 K are possible. A setting of "0" at this point will deactivate the automatic transmission of the set temperature.

In addition, the setpoint can be transmitted cyclically. The "*Cyclical transmission of room temperature*" parameter determines the cycle time (1 to 255 minutes). The value "0" (default) will deactivate the cyclical transmission of the setpoint temperature.

It should be noted that in case of deactivated cyclical transmission and deactivated automatic transmission, no setpoint temperature telegrams will be transmitted anymore.

Setting the "R" flag on the "Setpoint temperature" object makes it possible to read out the current setpoint. After return of bus voltage or after new programming with the ETS, the object value will be updated according to the current setpoint temperature value and transmitted actively to the bus.

13.5 Room temperature measurement

The room temperature controller measures the actual temperature cyclically and compares it with the given setpoint temperature. The control algorithm calculates the adjusted actuating variable from the difference between actual and setpoint temperature.

In order to always ensure a fault-free and effective room temperature control, it is very important to determine the exact actual temperature.

The room temperature controller features an intergrated temperature sensor. Alternatively (e.g. if the room temperature controller has been installed in an unfavourable location or operates in difficult conditions, for instance, in a moist atmosphere) or additionally (e.g. in large rooms or halls), a second KNX/EIB temperature sensor externally coupled via the bus or an external sensor at channel 4 of the pushbutton interface can be used to determine the actual value.

When choosing the installation location of the controller or the external sensor, the following points should be considered:

- The controller should not be installed in multiple combinations, especially when flush-mounted dimmers are installed in the same combination.
- The sensors should not be installed in the vicinity of large electrical consumers (heat radiation).
- The sensor should not be installed in the vicinity of heaters or cooling systems.
- The temperature sensor should not be exposed to direct sunlight.
- The installation of sensors on the inside of an outside wall might have a negative impact on the temperature measurement.
- Temperature sensors should be installed at least 30 cm away from doors or windows and at least 1.5 m above the floor.

13.5.1 Temperature detection and determination of measured value

The "*Temperature detection*" parameter on the "*Room temperature measurement*" parameter page will determine which one of the sensors is used for sensing the actual temperature. The following settings are possible:

- "*Internal sensor*":

The temperature sensor integrated in the room temperature controller is activated. Thus, the actual temperature is determined only locally on the device. When parameterized as such, the control will start directly after a reset.

- "*External sensor*":

The actual temperature is determined only by the external temperature sensor. The internal sensor is deactivated. The external sensor must transmit the detected temperature value to the room temperature controller's 2-byte "*External temperature sensor*" (DPT-ID 9.001) object 24 . Alternatively or additionally, the room temperature controller can cyclically request the current temperature value (set "R" flag for the external sensor). For this purpose, the "*Interrogation interval for external sensor...*" parameter has to be set to a value > "0". The interrogation interval can be set from 1 minute to 255 minutes. This parameterization will cause the room temperature controller to wait for a temperature value telegram from the external temperature sensor after a reset until the control starts and an actuating variable, if applicable, is output.

- "*Internal and external sensor*":

With this setting the internal as well as the external temperature sensor is active. The external sensor must transmit the detected temperature value to the room temperature controller's 2-byte "*External temperature sensor*" (DPT-ID 9.001) object 24 . Alternatively or additionally, the room temperature controller can cyclically request the current temperature value (set "R" flag for the external sensor). For this purpose, the "*Interrogation interval for external sensor...*" parameter has to be set to a value > "0". The interrogation interval can be set from 1 minute to 255 minutes. This parameterization will cause the room temperature controller to wait for a temperature value telegram from the external temperature sensor after a reset until the control starts and an actuating variable, if applicable, is output.

The actually prevailing temperature is determined on the basis of the two measured temperature values. The weighting of the temperature values is determined by the "*Calculation of temperature based on internal / external measurement*" parameter. Depending on the different locations of the sensors or a possible non-uniform heat distribution inside the room, it is thus possible to adjust the actual temperature measurement. Often, those temperature sensors that are subject to negative external influences (for example, unfavourable location because of exposure to sun or heater or door / window directly next to it) are weighted less heavily.

Example:

Room temperature controller installed next to the entrance door (internal sensor). An additional external temperature sensor is installed on an inner wall in the middle of the room below the ceiling.

Internal sensor: 21.5°C (measuring range of internal sensor: 0 C ... + 40°C ±1%)

External sensor: 22.3 °C

Calculation of temperature: 30% to 70 %

Result: $T_{\text{result internal}} = T_{\text{intern}} \cdot 0.3 = 6.45^{\circ}\text{C}$, $T_{\text{result external}} = T_{\text{external}} \cdot 0.7 = 15.61 \text{ C} \rightarrow$

$T_{\text{Result actual}} = T_{\text{Result intern}} + T_{\text{Result extern}} = 22.06 \text{ C}$

13.5.2 Calibrating the measured values

In some cases it may be required to calibrate the temperature measurements of the internal and external sensor. A calibration becomes necessary, if the temperature measured by the sensors stays permanently below or above the actual room temperature in the vicinity of the sensor. The actual room temperature should be determined by a reference measurement with a calibrated temperature measuring device.

The "*Calibration of internal sensor...*" or "*Calibration of external sensor...*" parameter on the "*Room temperature controller function – room temperature measurement*" parameter page allows to parameterize the positive temperature adjustment (increase, factors: 1...127) or the negative adjustment (temperature decrease: factors – 128...-1) in steps of 0.1°C. Thus, the calibration is made only once and is the same for all operating modes.

Notes:

- The measured value has to be increased, if the value measured by the sensor lies below the actual room temperature. The measured value has to be decreased, if the value measured by the sensor lies above the actual room temperature.
- When the measured values from internal and external sensor are used, the actual value is calculated on the basis of the adjusted value.

13.5.3 Transmitting the actual temperature

The measured actual temperature can be actively transmitted to the bus via the "*Actual temperature*" object 23. The "*Transmission when setpoint temperature changes by...*" parameter on the "*Room temperature controller functions – room temperature measurement*" parameter page determines the temperature value by which the actual value has to change in order to have the actual temperature value transmitted automatically via object 23. Temperature value changes between 0.1 C and 25.5°C or 0.1 K and 25.5 K are possible. A setting of "0" at this point will deactivate the automatic transmission of the actual temperature.

In addition, the actual value can be transmitted cyclically. The "*Cyclical transmission of room temperature*" parameter determines the cycle time (1 to 255 minutes). The value "0" (default) deactivates the cyclical transmission of the actual temperature value.

Setting the "R" flag on the "Actual temperature" object makes it possible to read out the current actual value. It should be noted that in case of deactivated cyclical transmission and deactivated automatic transmission, no setpoint temperature telegrams will be transmitted anymore.

After return of bus voltage or after new programming with the ETS, the object value will be updated according to the actual temperature value and transmitted to the bus.

If no temperature value telegram has as yet been received from the external sensor when such an external sensor is used, only the value provided by the internal sensor will be transmitted. If only the external sensor is used, the value "0" will be in the object after a reset. For this reason, the external temperature sensor should always transmit the current value after a reset.

13.6 Disable functions of the room temperature controller

In certain operating conditions it may be required to deactivate the room temperature control. For example, the control can be switched-off during the dew point mode of a cooling system or during maintenance work on the heating or cooling system.

The "*Switch-off controller (dew-point mode)*" parameter on the "*Room temperature controller functions*" parameter page enables the "*Disable controller*" object 40 when set to "*via object*". In addition, the controller disable function can be permanently deactivated when set to "*no*" (default).

If a "1" telegram is received via the enabled disable object, the room temperature control is completely deactivated. In this case all actuating variables = "0" and the "dew-point operation" LED is lit up (wait for 30 sec actuating variable update interval). The controller, however, can be operated in this case.

In the 2-stage heating or cooling mode, the additional stage can be separately disabled. The "*Disable object additional stage*" parameter on the "*Room temperature controller functions*" parameter page will enable the "*Disable additional stage*" object 41 when set to "*yes*". In addition, the disable function of the additional stage can be permanently deactivated when set to "*no*" (default).

In case a "1" telegram is received via the enabled disable object, the room temperature control is completely deactivated by the additional stage. The actuating variable of the additional stage is "0" while the basic stage continues to operate.

A disable is always deleted after a reset (return of bus voltage, ETS programming operation).

13.7 Valve protection

A valve protection may be carried out periodically in order to prevent the addressed control valves of the heater or cooling system to become calcified or stuck. The "*Valve protection*" parameter on the "*Room temperature controller function*" parameter page will activate the valve protection when set to "*yes*".

This type of protection is generally started not only for non-active actuating variable outputs, i.e. for outputs which have not requested any heating or cooling energy over the past 24 hours.

For these outputs, the controller will periodically set the actuating variable to the maximum value once a day for a duration of approx. 5 minutes based on the following parameterization:

Actuating variable output not inverted: 1-bit actuating variable: "1", 1-byte actuating variable: "255",

Actuating variable inverted: 1-bit actuating variable: "0", 1-byte actuating variable: "0".

Thus, even valves closed for prolonged periods will be shortly opened on a regular basis.

13.8 Fan control:

The room controller has a fan control mode which can be used when the room temperature control works internally as a PI controller with continuous or switching (PWM) actuating variable output. Depending on the operating mode of the room temperature control, the fan control can be based on different controller actuating variables. For this purpose, the plug-in has the two parameters "*Fan operating mode – controller basic stage*" and "*Fan operating mode – controller additional stage*".

- In single-stage room temperature control, only the parameter "*Fan operating mode – controller basic stage*" is evaluated. In this case, the user can specify whether the fan is to be activated during heating and/or cooling.
- In two-stage room temperature control, the fan control can make use of the basic stage or of the additional stage for heating and for cooling. The simultaneous use of the basic and the additional stage within the same operating mode is not possible.

The fan control supports up to 8 levels with the option of presetting the number of intensity levels actually used. Depending on the actuator controlling the fan, switching can be performed with a 1-byte object or with separate 1-bit objects

- In case of the 1-byte object, the number of the respective fan intensity level or a value of "0" is transmitted.
- In case of the 1-bit objects, the presettable "waiting time during level switch-over" is started before fan intensity level switching can take place. When this time has elapsed, the object of the previous stage is set to "0". Only after the previous bit is "0" will the object of the new intensity level be set to "1".

The fan control can work automatically dependent on the room temperature control, but it can also be controlled manually. The two operating modes are switched over with the 1-bit object "*Ventilation, automatic/manual*". The parameter "*Interpretation object fan control automatic/manual*" defines the object polarity for automatic or manual operation. This parameter specifies at the same time the operating mode that will be active after a reset of the device. In this case, the fan control works in the mode corresponding to the value of "0".

13.8.1 Automatic fan control

The determination of the fan stage in the automatic mode is based on the internal continuous output variable of the room temperature controller. This actuating variable can be limited at the lower and upper end of the range respectively with the two parameters "*Actuating variable is 0% until internal actuating variable exceeds...*" and "*Actuating variable is 100% until internal actuating variable exceeds...*". In addition, the variable can be still be raised by a constant value with the parameter "*Actuating variable offset*". In case the calculation leads to results greater than 100%, the values are limited automatically by the room controller.

This actuating variable is then compared in the fan control with the thresholds parameterized for the individual intensity levels. When a threshold is exceeded, the control activates the next level. In case of a decreasing actuating variable, the control moreover observes a defined hysteresis which is the same for all thresholds.

When the actuating variable exceeds the first threshold, the fan control evaluates the parameter "*Start with level...*" which means that the control can switch the fan temporarily to a higher level. In automatic operation, the control always switches from the actual level only into the next higher or the next lower level once the motor is running. Due to the "Waiting time during level switch-over" parameter, there is always a short pause between individual switching actions.

13.8.2 Manual fan control

When the fan control works in the automatic mode and when the manual fan control key is pressed, the fan control switches over into the manual mode.

The response of the fan control depends on the setting of the parameters "*Fan intensity level when switching over to manual*" and "*Start with level...*" and on the previously active fan level in the automatic mode.

- If the parameter "*Fan intensity level when switching over to manual*" requires a defined intensity level of between 1 and 8, the control will set this intensity level. The setting of the "*Start with level...*" parameter is taken into account in this case.
- If the parameter "*Fan intensity level when switching over to manual*" is set to "*fan level OFF*", the control will shut off the fan. The "*Start with level...*" parameter is taken into account on the next press of the manual mode control key.
- If no defined level is specified in the "*Fan intensity level when switching over to manual*" parameter (setting: "no change") and if the fan was off in the automatic mode, it will remain off. The "*Start with level...*" parameter is taken into account on the next press of the manual mode control key.

Each further press on the key increases the current fan intensity level by one step until the highest level is reached. The next press will then cause the fan control to switch to the "Off" position. Thereafter, each following press will then again raise the fan intensity level by one step. The "*Start with level...*" parameter is now ignored until the control switches over again into the automatic mode.

When the fan is shut off manually while running at the highest intensity level, it will continue to run until the parameterized "fan shut-off delay heating" or "fan shut-off delay cooling" delay has elapsed. The shut-off delay will be aborted if the manual mode control key is pressed again within this delay. In this case, the fan switches off briefly and then at once back to level 1.

13.8.3 Higher-ranking operating modes

Normally, the fan control works automatically and dependent on the room temperature control or dependent on the manual control operations of the user. Additionally, the following three operating modes have a higher priority (in ascending order):

- Fan protection: The fan protection function can be used to switch a fan that has not been in operation for a prolonged period temporarily to maximum intensity. For this purpose, the "Ventilation, fan protection" communication object is available in the ETS. When this object receives a value of "1", the fan protection function is active. The response at the end of the fan protection function depends on the preceding operating mode. In the automatic mode, the fan is switched to the intensity determined by the room temperature controller. In the manual mode, the fan switches off and can then be switched on again manually. The "Start with level..." parameter is taken into account in this case.
- When the fan control is inactive*, the fan can only be activated via the fan protection function. In this case, the fan is controlled directly via the object value. The fan protection function activates the highest fan intensity level and cannot be influenced by any other parameter (e.g. forced-control or level limitation).

*) Parameterization example: The controller is in the operating mode "Basic and additional heating and cooling" / "Fan control for basic heating" and the controller is presently in the cooling mode. In this case, fan control is inactive.
- Level limitation: If the ventilation is not to exceed a certain level at night, for instance, the parameter "Level limitation (max. fan level)" can be used. In this case, the ETS shows the "Ventilation, level limitation" communication object. Level limitation is active when the object receives the value "1". If a higher level has been set by the automatic or manual mode or by the fan protection function at this time, the ventilation is automatically reduced in successive steps. The response at the end of level limitation depends on the current operating mode. In the manual mode, the limitation level is maintained until the fan level is raised again manually. In the automatic mode, the fan gradually approaches the level determined by the room temperature controller. In the fan protection mode, the fan is switched immediately to the highest possible level.
- Forced-control position: Forced control has the highest priority. As soon as the communication "Ventilation, forced control" receives a "1", the fan is switched immediately to the parameterized level. The response at the end of forced control depends on the current operating mode. In the manual mode, the fan switches off and can then be switched on again by another manual operation. In the automatic mode, the fan switches off and then gradually approaches the level determined by the room temperature controller. In the fan protection mode, the fan switches off and is then switched immediately to the highest possible level.

14 Display functions

The room controller is equipped with a backlit LCD.

- In the lower part, the display features two rows with defined symbols representing specific operating states of the device.
- In the upper part, texts specified in the project design phase can be displayed in different font sizes. This part of the display screen is also used for operator prompting purposes on the second control level for setting device functions locally.

14.1 Display elements

The following illustration shows the basic design of the LCD screen with the text display and the different symbols.

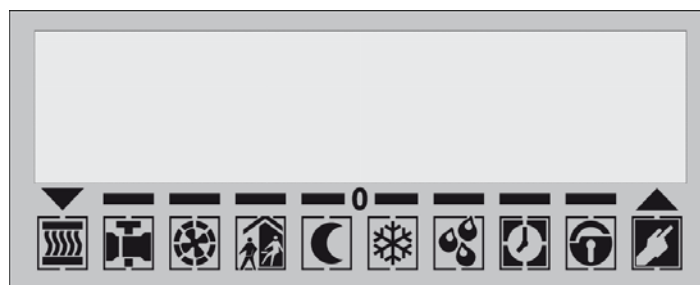

The symbols of the upper row have the following functions:

- ▼ Symbol indicating shut-off, dimming, blind lowering, value reduction
- ... -- 0 Setpoint value shift towards colder active
- 0 No setpoint value shift
- 0 -- ... Setpoint value shift towards warmer active
- ▲ Symbol indicating switch-on, brightness increase, blind raising, value increase

The symbols of the lower row consist partly of several elements and can also be displayed in combination with other symbols. They have the following functions:

- Heating with heating intensity level indicator
- Cooling with cooling intensity level indicator
- Valve symbol: energy supply; heating or cooling in progress.
- Fan control with fan intensity level indication
- Comfort operation mode
- Standby operation mode
- Night-time operation mode
- Frost and heat protection
- Night-time comfort prolongation
- Frost protection or heat protection comfort prolongation
- Dew-point operation mode indication; controller is disabled
- Switching channels 1...4 are active:
- Locked symbol: Key-lock
- Hand symbol: Info-mode is active

14.2 Backlighting

The display backlighting can be permanently on or off or switched or dimmed driven by specific events. The backlighting can be activated by the following events:

- a key-press,
- night-time operation of the room temperature control
- the normal or inverted value of a separate switching object
- the value of a separate 1-byte object

The activation of the backlighting by key-press can be combined with anyone of the other events. If the backlighting is activated by key-press, it will be automatically deactivated by the room controller after a presettable time. If the backlighting is activated by one of the other events, it will be deactivated by the room controller after the end of this event.

Brightness and contrast can be adjusted in the menu of the second control level.

14.3 Info-mode:

After a key-press, the screen can display texts describing the function assigned to the key and the value to be transmitted. One distinguishes between single- and double press operation of a key. In the single-press mode, the info text is displayed and the normal key function executed in parallel after one press of the key. In the double-press mode, the first key-press only displays the info text. The normal key function is executed only after the second key-press.

In the info mode, the screen displays three lines of text overwriting the normal display temporarily.

- The first line displays the text "Info Mode"
- The second line displays freely programmable text composed of 18 characters max.
- The third line optionally displays another freely programmable text equally composed of 18 characters max. or an automatically generated text depending on the key function.

The info mode can be switched on or off in four different ways:

- By pressing the key of the room controller defined as the info key. The key can be parameterized to distinguish between single-press and double-press operation.
- In the menu of the second control level. On this level, single-press or double-press operation can be selected locally.
- By a telegram to the 1-bit communication object "Info mode". The selection between single-press or double-press operation is not available in this case. When the T-flag of the object is set, the room controller can also transmit the current value.
- The state after a new start of the application program can be defined in a parameter. This state can be changed in operation as described above.

14.4 Display pages

In the project design, up to four pages max. with up to three lines can be created.

The pages can show values partly referred to internal values of the room controller as, for instance, the setpoint temperature of the room temperature control or to independent communication objects.

14.4.1 Page changes:

A page change can be controlled by three different events with different priority.

- Cyclical page changing has the lowest priority. For this type of change, a time of up to one minute can be parameterized. After this time, the controller automatically displays the next page. When the last page is reached, the cycle restarts with the first page. For pages 2 and 4, the user can specify whether he wants to include these pages in the automatic cycle.
- Deliberate page changes can be achieved by parameterizing the keys of the room controller. The options "Scroll forward to next page", "Scroll backwards to preceding page", "Recall specific page" or "Alternate between page 1 and another page" are available. The key function equally allows to change between pages which are not recalled in the course of the automatic cycle. A press on the key restarts the time of the cyclical change. After this time, the automatic change continues from the page last recalled cyclically.
- The parameter "Display page recall" can be used optionally with the 1-bit object "fixed page recall" or the 1-byte object "variable page recall". If one of these objects is used for page changing, the two previously described page changing methods can be overridden. If the "fixed page recall" object is used, the controller jumps automatically to the parameterized page when a "1" is received. If the "variable page recall" object is used, a value from "1" to "4" permits recalling any predefined page. If the recalled page is not programmed, the telegram will be ignored. A value of "0" re-enables the automatic cycle or the manual page change.

14.4.2 Page layout

During the project design, up to four display pages with one, two or three display lines can be defined. For this purpose, two proportional fonts with a character height of 20 and 10 pixels are available.

- The one-line display makes use of the large font.
- The two-line display uses the large font for the first line and the small font for the second line. Alternatively, the first line can be used for displaying a value with the large font and the unit text with the small font.
- The three-line display is only used with the small font.

All characters exceeding the screen display range will be cut off.

In addition to text, a symbol with a size of 30 x 30 pixels can be displayed at the right margin of the screen. Texts and values may be hidden when a symbol is displayed. 30 symbols are stored in the memory of the device (see next page). A separate program permits replacing the predefined symbols by other symbols.



Weather					
1		clouds	2		rain
3		wind	4		storm
5		night	6		sun (day)
7		sun north	8		sun east
9		sun south	10		sun west
Temperature					
11		inside temperature 1	12		inside temperature 2
13		outside temperature	14		setpoint temperature
15		actual temperature			
Timer clock					
			16		presence
17		party	18		holidays
Blinds / shutters / awnings					
19		blinds / shutters UP	20		blinds / shutters DOWN
21		blind / shutter in motion	22		awning extended
Filling					
23		tank empty	24		tank full
Multimedia					
25		request pages	26		multimedia
27		music title playing	28		new music title
29		O.K.	30		adjust

The one-line display makes use of the large font only. The following information can be displayed:

- Time of day
- Time-of-day and weekday
- Date
- Setpoint temperature
- Actual temperature
- External / outside temperature
- Date + time of day
- Time of day and date
- Time of day + setpoint temperature
- Time of day + actual temperature
- Time of day + external / outside temperature

The format of the displayed values is predefined.

The first line of the two-line display corresponds largely to the one-line display. In addition, the following information can be displayed:

- Value display fix DPT 5.xxx (EIS 6)
- Value display DPT 9.xxx (EIS 5)
- Value display DPT 14.xxx (EIS 9)

The second line of the two-line display and the three-line display offer the same settings. The small font is used.

- Switching
- Dimming
- Blind/shutter
- Light-scene
- Value display DPT 5.xxx (EIS 6)
- Value display DPT 6.xxx (EIS 14 signed)
- Value display DPT 7.xxx (EIS 10 unsigned)
- Value display DPT 8.xxx (EIS 10 signed)
- Value display DPT 9.xxx (EIS 5)
- Value display DPT 12.xxx (EIS 11 unsigned)
- Value display DPT 13.xxx (EIS 11 signed)
- Value display DPT 14.xxx (EIS 9)
- Value display DPT 16.xxx (EIS 15)
- Static text

14.4.3 Display examples

The following illustrations are to intended demonstrate the basic options for different line displays. The actual space requirements for texts deviate from the display examples as the fonts are not the same as those used in the room controller.

The placeholder shown in the illustrations is always he same.

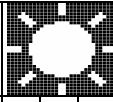
Time of day:												
with symbol	1	2	:	2	4							
without symbol	1	2	:	2	4							
<ul style="list-style-type: none"> - with one-line display and for first line of the two-line display - left-aligned display of time of day: - the leading zero of the hour is replaced by a special blank 												

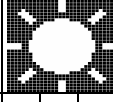
Time of day + weekday												
with symbol	M	o	n		1	4	:	3	5			
without symbol	M	o	n		1	4	:	3	5			
<ul style="list-style-type: none"> - with one-line display and for first line of the two-line display - left-aligned display of time of day and weekday - the leading zero of the hour is replaced by a special blank - Weekdays can be displayed with three characters for languages where this is necessary or standard practice. The blank space between the weekday and the time of day can be retained. 												

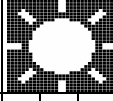
Date												
with symbol	1	2	.	1	2	.	2	0	0	6		
without symbol	1	2	.	1	2	.	2	0	0	6		
<ul style="list-style-type: none"> - with one-line display and for first line of the two-line display - left-aligned display of the date - leading zeroes of day and month are suppressed - depending on parameterization, the date is displayed as follows: dd.mm.yyyy, mm.dd.yyyy, yyyy.dd.mm or yyyy.mm.dd 												

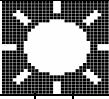
Setpoint temperature or actual temperature												
with symbol	2	0	.	5	°	C						
without symbol	2	0	.	5	°	C						

- with one-line display and for first line of the two-line display
- left-aligned display of setpoint temperature or of actual temperature
- leading zero is suppressed
- display value unsigned

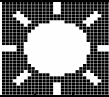
External / outside temperature												
with symbol	-	1	0	.	5	°	C					
without symbol	-	1	0	.	5	°	C					

- with one-line display and for first line of the two-line display
- left-aligned display of temperature
- leading zero suppressed
- display of negative sign, the positive sign is suppressed

Date + time of day (no symbol display)														
without symbol	1	2	.	1	2	.	0	6		2	2	:	1	5

- with one-line display and for first line of the two-line display
- display only without symbol
- left-aligned display of the date
- leading zeroes of day and month are suppressed
- depending on parameterization, the date is displayed as follows: dd.mm.yy, mm.dd.yy, yy.dd.mm or yy.mm.dd
- right-aligned display of time of day:
- leading zero of hour is suppressed

Time of day + date (no symbol display)														
without symbol	2	2	:	1	5		1	2	.	1	2	.	0	6
<ul style="list-style-type: none"> - with one-line display and for first line of the two-line display - display only without symbol - left-aligned display of time of day: - the leading zero of the hour is replaced by a special blank - right-aligned display of the date - leading zeroes of day and month are suppressed - depending on parameterization, the date is displayed as follows: dd.mm.yy, mm.dd.yy, yy.dd.mm or yy.mm.dd 														

Time of day + setpoint temperature or Time of day + actual temperature (no symbol display)														
without symbol	2	2	:	1	5			2	3	.	5	°	C	
<ul style="list-style-type: none"> - with one-line display and for first line of the two-line display - display only without symbol - left-aligned display of time of day - the leading zero of the hour is replaced by a special blank - right-aligned display of temperature - leading zero is suppressed - display value unsigned 														

Time of day + external / outside temperature (no symbol display)														
without symbol	2	2	:	1	5			-	1	0	.	5	°	C
<ul style="list-style-type: none"> - with one-line display and for first line of the two-line display - display only without symbol - left-aligned display of time of day - the leading zero of the hour is replaced by a special blank - right-aligned display of temperature - leading zero is suppressed - display of negative sign, the positive sign is suppressed 														

Value display fixed DPT 5.xxx (EIS 6)
with large unit text

with symbol	5	0	%	U	n	i	t													
without symbol	5	0	%	U	n	i	t													

- used for first line of the two-line display
- Display of object data type 5.xxx
- Display format: 0..255 or as shown 0%..100%
- left-aligned display of value
- display limited to three digits max., leading zeroes are suppressed
- for 0%..100%, the '%' sign is displayed directly behind the value without a space
- unit text with 10 characters max., freely programmable
- unit text displayed with 20-pixel or 10-pixel font
- unit texts follows value or '%' sign directly without a space

Value display fixed DPT 5.xxx (EIS 6)
with small unit text

with symbol	5	0	%	u	n	i	t														
without symbol	5	0	%	u	n	i	t														

- used for first line of the two-line display
- Display of object data type 5.xxx
- Display format: 0..255 or as shown 0%..100%
- left-aligned display of value
- display limited to three digits max., leading zeroes are suppressed
- for 0%..100%, the '%' sign is displayed directly behind the value without a space
- unit text with 10 characters max., freely programmable
- unit text displayed with 20-pixel or 10-pixel font
- unit texts follows value or '%' sign directly without a space

Value display DPT 9.xxx and 14.xxx
with large unit text

with symbol	2	0	K	.	1	u	x															
without symbol	1	2	3	4	5	6	7	8	9	.	1	2	3	E								

- used for first line of the two-line display
- left-aligned display of value
- Display format parameterizable within the following limits:
 - offset: -100000.000..+100000.000 (default: 0.000)
 - amplification: 0.001..100000.000 (default: 1.000)
 - digits to the left of decimal point 0..9 (default: 3)
 - digits after the decimal point: 0..3 (default: 0)
 - sign: selectable, positive sign generally not displayed
- leading zeroes are suppressed
- positive sign is generally suppressed
- negative sign always directly before 1st numeral
- unit text with 10 characters max., freely programmable
- unit text displayed with 20-pixel or 10-pixel font
- unit texts follows value or '%' sign directly without a space

Value display fixed DPT 9.xxx and 14.xxx
with small unit text

with symbol	2	0																				
without symbol	1	2	3	4	5	6	7	8	9	.	1	2	3	E								

- used for first line of the two-line display
- left-aligned display of value
- display format parameterizable within the following limits:
 - offset: -100000.000..+100000.000 (default: 0.000)
 - amplification: 0.001..100000.000 (default: 1.000)
 - digits to the left of decimal point: 0..9 (default: 3)
 - digits after the decimal point: 0..3 (default: 0)
 - sign: selectable, positive sign generally not displayed
- leading zeroes are suppressed
- positive sign is generally suppressed
- negative sign always directly before 1st numeral
- unit text with 10 characters max., freely programmable
- unit text displayed with 20-pixel or 10-pixel font
- unit texts follows value or '%' sign directly without a space

Time of day and / or date

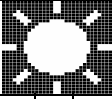
with symbol	M o n 1 4 : 3 5	
	T i m e + d a y M o n 1 4 : 3 5	
without symbol	M o n 1 4 : 3 5	
	T i m e + d a y M o n 1 4 : 3 5	

- left-aligned, freely programmable text
 - max. 18 characters
- right-aligned display of weekday, time of day and / or date
 - the leading zero of the hour is replaced by a special blank
 - Weekdays can be displayed with three characters for languages where this is necessary or standard practice. The blank space between the weekday and the time of day can be retained.
 - depending on parameterization, the date is displayed as follows: dd.mm.yy, mm.dd.yy, yy.dd.mm or yy.mm.dd

Value display

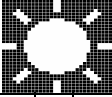
with symbol	M o n 1 4 : 3 5	
	v a l 1 2 3 4 5 6 7 8 9 . 1 2 3 U	
without symbol	M o n 1 4 : 3 5	
	v a l . 1 2 3 4 5 6 7 8 9 . 1 2 3 U n i t	

- left-aligned, freely programmable text
 - 18 characters max.
- right-align value display
 - display format parameterizable within the following limits:
 - offset: 0.000..+100000.000 (default: 0.000)
 - amplification: 0.001..100000.000 (default: 1.000)
 - digits to the left of decimal point: 0..9 (default: 3)
 - digits after the decimal point: 0..3 (default: 0)
 - sign: depending on datapoint type
 - unit text (10 characters max.) follows value directly without a space

Dimming

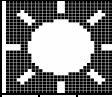
with symbol	M o n 1 4 : 3 5	
	D i m m i n g 7 8 %	
without symbol	M o n 1 4 : 3 5	
	D i m m i n g 7 8 %	

- left-aligned, freely programmable text
 - 18 characters max.
- right-align display of brightness value
 - 0%..100%
 - leading zeroes are suppressed
 - the '%' sign follows the value directly without a space

14.5 Second operator control level

The second operator control level enables the user to change various basic settings of the device locally without using the ETS. To prevent inadvertent changes to essential functions, the device can be programmed in such a way that the access to individual settings or also to the whole second operator control level is denied. The access to the second control level is not possible either, if a key-lock is active. The settings made by the user on the second operator control level remain unchanged even after a reset caused, for instance by a bus voltage failure.

The room controller is switched over to the second operator control level by a pressing keys 1 and 3 simultaneously. A repeated press on the same keys causes the room controller to quit the second operator control level.



Depending on the setting of the parameter "Save changes after manual quitting", the changed settings are either saved or discarded. The three parameters "Automatic quitting of the second operator control level", "Time to automatic quitting" and "Save changed settings" define whether the room controller quits the second operator control level automatically when no entries are made within a specified delay and whether all changed settings are to be saved or discarded in this case. Besides the above-mentioned two possibilities of quitting the second control level menu at any position, the main menu offers the two options "Save" and "Abort" which can be used for ending the second operator control level.

The functions of the second operator control level are organized in a menu/submenu structure. The menus is controlled with keys 1 thru 4. For user guidance purposes, the functions of keys 1 thru 4 are visualized at the sides of the display screen. If a key has no function in the respective context, the corresponding symbol is switched off.

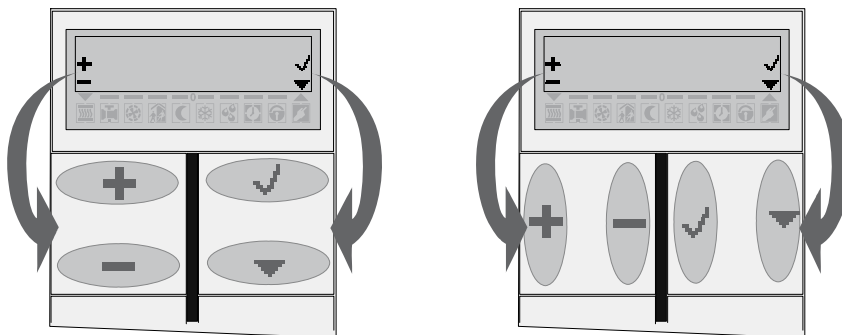

Generally, the keys have the following functions:

- + : change between value options, increasing of the set value
- : change between value options, decreasing of the set value
- ✓ : jump to selected submenu, confirming of the set value and return to main menu
- ▼ : next entry; if end of list is reached, continue with first menu item

The main menu of the second operator control level presents itself as follows:

```

2nd level
central alarm syst. .. ✓
    
```

"2nd level" is the heading.

"central alarm Syst." is the menu item actually selected. ✓ opens this submenu.

"info mode" is the following menu item. ▼ selects this item.

+ and – are blanked in this screen.

Items of the main menu:

- central alarm syst.
- info mode
- c.-action controller
- presence
- setpoint point shift
- mode of operation
- fan intens. levels
- device info
- display
- saving
- aborting

The sequence of the menu items is predefined. There are two ways of influencing the main menu configuration with the ETS:

- A main menu item disabled by parameterization does not appear on the list.
- The menu item displayed when the second operator control level is called up can be selected.

In the submenu "Central alarm unit", the room controller can display messages from the central alarm unit. For this purpose, the communication object "Central alarm unit selection" transmits a telegram to the central alarm unit. The central alarm unit then transmits three telegrams to the 14-byte communication objects "Central alarm unit line 1" to "Central alarm unit line 3". These texts are then displayed on the screen. If no texts are received, the screen displays "- - -".

The keys have the following functions:

+: no function, blanked out

-: no function, blanked out

✓: return to main menu

▼: call up following messages

In the info mode submenu, the room controller displays the current status.

The keys have the following functions:

±: Change between "single-press operation", "double-press operation", "OFF"

✓: confirmation of entry and return to main menu

▼: no function, blanked out

The "continuous-action controller submenu has several entries which can be disabled separately in the parameterization. If an entry can be edited, the respective value blinks. If an entry is disabled, the respective value does not blink.

The keys have the following functions:

- ±: selects the respective values
- ✓: confirms an entry and returns to main menu
- ▼: selects between
 - "comfort mode", setting of setpoint temperature
 - "heating-standby", setting of temperature reduction
 - "cooling-standby", setting of temperature increase
 - "heating nt reduction", setting of temperature reduction
 - "cooling nt increase", setting of temperature increase
 - "heat protection", setting of setpoint temperature
 - "frost protection", setting of setpoint temperature
 - "cooling max.", setting of limit value

In the "presence" submenu, the room controller displays the current status. The setting acts like the actuation of the presence key.

The keys have the following functions:

- ±: changes between "on", "off"
- ✓: confirms the entry and returns to main menu
- ▼: no function, blanked out

The "setpoint shift" submenu permits gradual shifting of the setpoint. In the third line, the device displays the numerical value of the shift and also a bargraph.

The keys have the following functions:

- ±: changes the shift
- ✓: confirms and returns to main menu
- ▼: no function, blanked out

In the "mode of operation" submenu, the current status of the device can be displayed and changed.

The keys have the following functions:

- ±: changes between "Comfort mode", "Standby mode", "Night-time mode", "Frost/heat protection"
- ✓: confirms and returns to main menu
- ▼: no function, blanked out

In the "fan intens. levels:" submenu, the current status of the device can be displayed and changed.

The keys have the following functions:

- ±: changes between "Automatic mode", "OFF", "Manual" level 1", ... "Manual": level 8"

The selection of the manual levels depends on the parameterized number of levels.

- ✓: confirms and returns to main menu
- ▼: no function, blanked out

The "Device info" submenu informs about the hardware and software in use. These settings cannot be changed.

The keys have the following functions:

- ±: no function, blanked out
- ✓: returns to main menu
- ▼: goes to next info entry

The "display" submenu shows three pages.

: selection of the respective values

✓: confirms and returns to main menu

▼: changes between

"contrast", setting of contrast from 0% to 100%. The changes made with the ± keys are immediately displayed.

"brightness", setting of brightness from 0% to 100%. The changes made with the ± keys are immediately displayed. The set value is used when the backlighting is switched by a key-press, by the night-time mode of the room temperature controller or via the 1-bit object.

The 1-byte value object for the backlighting brightness overwrites the set value permanently.

A setting of 0% switches the backlighting off.

"pixel test", activates for 2 seconds all pixels and symbols of the display screen. Thereafter, the device is switched back automatically to the main menu.

15 Parameters		
Description:	Values:	Remarks:
15.1 General parameters		
 General		
Transmit delay after reset or bus voltage return	yes no	<p>After a reset (e.g. after loading of an application program or the physical address or after return of bus voltage), the room controller (only 8-fold type) can automatically transmit telegrams for the room temperature controller extension and room temperature measurement functions. In case of the controller extension, the room controller attempts to get values from the room temperature controller by means of read telegrams in order to update the object states. In case of the room temperature measurement, the room controller transmits the current room temperature to the bus after a reset.</p> <p>If there are also other bus devices besides the room controller transmitting telegrams immediately after a reset, it may be useful to activate the transmit delay for automatically transmitting objects in order to reduce the bus load.</p> <p>When the transmit delay is activated (setting: "yes", the room controller calculates the delay time from the device number of its physical address. The controller then waits 30 secs maximum before transmitting telegrams.</p>
ON-time of status LEDs as actuation indicators	1s 2s 3s 4s 5s	<p>This parameter defines the time the status LED is lit up to indicate actuation. The setting concerns all status LEDs whose function is set to "Actuation indicator"</p>

Function of status LED	<p>always OFF</p> <p>always ON</p> <p>switching via object</p> <p>inverted switching via object</p>	<p>This parameter defines the function of the operation LED.</p> <p>The operation LED is always off.</p> <p>The operation LED is always on, for instance, as orientation lighting.</p> <p>The operation LED is controlled by a separate communication object ("1" = ON; "0" = OFF).</p> <p>The operation LED is controlled with inversion by a separate communication object ("1" = OFF; "0" = ON).</p> <p>Besides this function, the operation LED can display different states by means of other blinking rates. These comprise the programming mode, the confirmation of full-surface actuation or the message that an application has not been loaded.</p>
Date display	<p>dd.mm.yy</p> <p>mm.dd.yy</p> <p>yy.dd.mm</p> <p>yy.mm.dd</p>	<p>This parameter defines the sequence in which the day, month and year info is displayed on the screen.</p> <p>Depending on the datapoints to be displayed and the font used, the year is indicated with two or four digits.</p>
Time-of-day display	<p>24 hours</p> <p>12 hours</p>	<p>To display the time of day, the room controller can use either the 12- or the 24-hour format. The 12-hour format cannot distinguish between a.m. and p.m.</p>
Request date/time of day	<p>no</p> <p>yes</p>	<p>If the parameter is set to "yes" and if the room controller has not received a valid time information during the last 24 hours, the controller uses the "Request date/time of day" object to transmit a telegram to a master clock at 04:00.</p> <p>If the controller has not received a valid date information during the past 24 hours, it transmits a telegram to the master clock at 0:00.</p>
Request date/time of day with	<p>"1" telegram</p> <p>"0" telegram</p> <p>German (DE)</p> <p>English (EN)</p> <p>Spanish (ES)</p> <p>Dutch (NL)</p> <p>French (FR)</p> <p>Norwegian (NO)</p>	<p>This is the value transmitted by the room controller for requesting the date and the time of day from a master clock.</p> <p>This parameter indicates the language in which pre-formulated texts (e.g. in the info mode) are displayed on the screen.</p>
Second operator control level	<p>disabled</p> <p>enabled</p>	<p>This parameter enables or disables all the functions of the second operator control level together. When the second level is enabled, the ETS shows further parameters.</p>

Second operator control level

Central alarm unit options on second operator control level	invisible visible	This parameter can be used to enable the access to messages from the alarm central unit on the second control level.
Continuous-action controller options on second operator control level	invisible visible	This parameter can be used to enable the access to the basic settings of the continuous-action controller on the second control level.
Presence options on second operator control level	invisible visible	This parameter can be used to enable the access to the presence function of the continuous-action controller on the second control level.
Setpoint shift options on second operator control level	invisible visible	This parameter can be used to enable the access to the setpoint shift of the continuous-action controller on the second control level.
Operating mode change-over on second operator control level	invisible visible	This parameter can be used to enable the access to the operating mode change-over of the continuous-action controller on the second control level.
Fan intensity level options on second operator control level	invisible visible	This parameter can be used to enable the access to the fan control on the second control level.
First menu item of second operator control level	Central alarm unit Info-mode: Continuous-action controller Presence Setpoint value shift Mode of operation Fan intensity levels	The selected menu item appears in the first position when the second control level is called up. The other menu item retain their position in the sequence.
Automatic quitting of the second operator control level	no yes	If there is no actuation on the second operator control level for a presettable time, the room controller can return automatically to the first control level.
Time to automatic quitting	10 s 20 s 30 s 1 min 2 min	This parameter fixes the time after which the room controller quits the second control level automatically if no actuation is sensed.
Save changes	no yes	When the room controller quits the second control automatically, all changes made can either be saved or discarded.
Save changes after manual quitting	no yes	The second control level can be quitted at any position within the menu after pressing keys 1 and 3 simultaneously. In this case, the room controller can either save or discard all changes made.

15.2 Pushbutton sensor

📁 Rocker / key selection

Function of keys 1 and 2 **as a rocker (rocker 1)**
(the same parameters are available for the other control surfaces / key pairs) as separate keys

For each control surface the user can independently specify whether it is to be used as a rocker with a common basic function or as two different keys with completely independent functions.

Depending on this choice, the ETS displays different communication objects and parameter pages.

If a control surface is parameterized as a rocker, it is also possible to activate a full-surface actuation with some basic functions.

Key layout left / right
key 1 / key 2 **top / bottom**
(the same parameters are available for the other control surfaces / key pairs)

For each control surface the user can specify whether the surface is to be divided horizontally or vertically. This arrangement fixes the actuation points of the control surface.

📁 Rocker 1 (keys 1/2) (only if "Function of keys 1 and 2 = as one rocker (rocker 1)!")

Function **Switching**
Dimming
blind
value transmitter 1 byte
value transmitter 2 bytes
scene extension
2-channel operation

This parameter is used to define the basic function of the rocker.

Depending on this choice, the ETS displays different communication objects and parameters.

Info text line 2 **info text L2 R1**

The info text entered here is displayed when a rocker is pressed. The text can be edited at the user's discretion and may consist of 18 characters max.

Info text line 3 top/left **predefined text (depending on key function)**
free text

Depending on the programmed function of the rocker, different texts are predefined for the third line in the device software.

As an option, also free texts can be entered. In this case, the ETS shows the next parameter.

Info text line 3 top/left **info text L3 top/left**

The info text entered here is displayed when a rocker is pressed. The text can be edited at the user's discretion and may consist of 18 characters max.

Info text line 3 bottom/right **predefined text (depending on key function)**
free text

Depending on the programmed function of the rocker, different texts are predefined for the third line in the device software.

As an option, also free texts can be entered. In this case, the ETS shows the next parameter.

Info text line 3 bottom/right **info text L3 top/left**

The info text entered here is displayed when a rocker is pressed. The text can be edited at the user's discretion and may consist of 18 characters max.

The status LEDs of a control surface can be programmed for independent LED functions which have no relationship with the basic functions of the rocker. This always results in the LED parameters described below...

If the function of the status LED = "Operating mode indicator (KNX controller)"

Status LED ON with	automatic mode comfort operation standby mode night-time operation frost /heat protection	The values of a communication object with data type 20.102 "HVAC Mode" are defined as follows: 0 = automatic 1 = comfort 2 = standby 3 = night-time 4 = frost/ heat protection
--------------------	--	---

The value "automatic" is used only by the "forced operating mode switch-over" objects
The status LED is on when the object adopts the parameterized value.

If the function of the status LED = "Controller status indicator"

Status LED ON with	comfort operation standby mode night-time operation frost /heat protection controller disabled heating / cooling controller inactive (dead zone operation) frost alarm
--------------------	--

The "Controller status" communication object of the controller extension function includes eight information units in one byte. This parameter defines which bit is to be indicated by the LED.

The controller status can be displayed only if the controller extension is enabled (parameter page "General")!

If the function of the status LED = "Comparator without sign"

Status LED ON with	reference value greater than received value reference value less than received value reference value equal to received value
--------------------	---

The status LED indicates whether the parameterized reference value is greater or less than or equal to the value of the "Status LED" object.

Reference value (0 ... 255)	0 ... 255
--------------------------------	------------------

This parameter defines the reference value to which the value of the "Status LED" object is compared.

If the function of the status LED = "Comparator with sign"

Status LED ON with	reference value greater than received value reference value less than received value reference value equal to received value
--------------------	---

The status LED indicates whether the parameterized reference value is greater or less than or equal to the value of the "Status LED" object.

Reference value (-128 ... 127)	-128 ... 0 ... 127
-----------------------------------	---------------------------

This parameter defines the reference value to which the value of the "Status LED" object is compared.

<p>If function of the rocker = "switching Function of status LED at the top</p>	<p>always OFF always ON Key-press indication status indicator (switching object) inverted status indicator (switching object) status indicator (LED object) inverted status indicator (LED object) operating mode indicator (KNX controller) controller status indicator (activate controller extension!) comparator without sign (1 byte) comparator with sign (1 byte)</p>	<p>With a switching function the status LED can...</p> <ul style="list-style-type: none"> • be permanently on or off independent of the communication objects, • signal a key-press, • signal the state of the communication object "Switching" • signal a state of the controller extension, • perform a comparison, • show the state of the own LED object. <p>Depending on this setting, the ETS may also display further LED parameters.</p>
<p>Function of status LED at the bottom</p>	<p>always OFF always ON Key-press indication status indicator (switching object) inverted status indicator (switching object) status indicator (LED object) inverted status indicator (LED object) operating mode indicator (KNX controller) controller status indicator (activate controller extension!) comparator without sign (1 byte) comparator with sign (1 byte)</p>	<p>With a switching function the status LED can...</p> <ul style="list-style-type: none"> • be permanently on or off independent of the communication objects, • signal a key-press, • signal the state of the communication object "Switching" • signal a state of the controller extension, • perform a comparison, • show the state of the own LED object. <p>Depending on this setting, the ETS may also display further LED parameters.</p>
<p>Command on pressing rocker 1.1</p>	<p>no reaction ON OFF TOGGLE</p>	<p>Depending on the "Key arrangement" parameter, these parameters define the reaction taking place when the top (or left-hand) rocker is pressed or released.</p>
<p>Command on releasing rocker 1.1</p>	<p>no reaction ON OFF TOGGLE</p>	
<p>Command on pressing rocker 1.2</p>	<p>no reaction ON OFF TOGGLE</p>	<p>Depending on the "Key arrangement" parameter, these parameters define the reaction taking place when the bottom (or right-hand) rocker is pressed or released.</p>
<p>Command on releasing rocker 1.2</p>	<p>no reaction ON OFF TOGGLE</p>	

<p>If function of the rocker = "dimming" Function of status LED at the top</p>	<p>always OFF always ON Key-press indication status indicator (switching object) inverted status indicator (switching object) status indicator (LED object) inverted status indicator (LED object) operating mode indicator (KNX controller) controller status indicator (activate controller extension!) comparator without sign (1 byte) comparator with sign (1 byte)</p>	<p>With a dimming function the status LED can...</p> <ul style="list-style-type: none"> • be permanently on or off independent of the communication objects, • signal a key-press, • signal the state of the communication object "Switching" • signal a state of the controller extension, • perform a comparison, • show the state of the own LED object. <p>Depending on this setting, the ETS may also display further LED parameters.</p>
<p>Function of status LED at the bottom</p>	<p>always OFF always ON Key-press indication status indicator (switching object) inverted status indicator (switching object) status indicator (LED object) inverted status indicator (LED object) operating mode indicator (KNX controller) controller status indicator (activate controller extension!) comparator without sign (1 byte) comparator with sign (1 byte)</p>	<p>With a dimming function the status LED can...</p> <ul style="list-style-type: none"> • be permanently on or off independent of the communication objects, • signal a key-press, • signal the state of the communication object "Switching" • signal a state of the controller extension, • perform a comparison, • show the state of the own LED object. <p>Depending on this setting, the ETS may also display further LED parameters.</p>
<p>Command on pressing rocker 1.1</p>	<p>no reaction Brighter (ON) Darker (OFF) brighter / darker (TOGGLE) brighter (TOGGLE) darker (TOGGLE)</p>	<p>Depending on the "Key arrangement" parameter, this parameter defines the reaction taking place when the top (or left-hand) rocker is pressed. If the room controller is to toggle on a brief press, the corresponding switching objects of other sensors with the same function must be linked with one another. In the "Brighter/darker (TOGGLE)" setting, the dimming objects must be interlinked as well so that the room controller can send the correct telegram on the next key-press.</p>

Command on pressing rocker 1.2	no reaction Brighter (ON) Darker (OFF) brighter / darker (TOGGLE) brighter (TOGGLE) darker (TOGGLE)	Depending on the "Key arrangement" parameter, this parameter defines the reaction taking place when the bottom (or right-hand) rocker is pressed. If the room controller is to toggle on a brief press, the corresponding switching objects of other sensors with the same function must be linked with one another. In the "Brighter/darker (TOGGLE)" setting, the dimming objects must be interlinked as well so that the room controller can send the correct telegram on the next key-press.
Time between switching and dimming rocker 1.1 (100 ... 50000 x 1 ms)	100 ... 400 ... 50000	This parameter defines how long the top (or left-hand) rocker must be pressed for the room controller to send a telegram.
Time between switching and dimming rocker 1.2 (100 ... 50000 x 1 ms)	100 ... 400 ... 50000	This parameter defines how long the bottom (or right-hand) rocker must be pressed for the room controller to send a telegram.
Advanced parameters	activated deactivated	When the advanced parameters are activated, the ETS shows the following parameters.
Advanced parameters activated...		
Increase brightness by	1,5 % 3 % 6 % 12,5 % 25 % 50 % 100 %	This parameter sets the relative dimming step when the brightness is increased. On each key-press, the brightness is changed at maximum by the parameterized step Especially with smaller dimming steps it is recommended that the room controller repeats the dimming telegrams automatically (cf. "Telegram repetition").
Reduce brightness by	1,5 % 3 % 6 % 12,5 % 25 % 50 % 100 %	This parameter sets the relative dimming step when the brightness is reduced. On each key-press, the brightness is changed at maximum by the parameterized step Especially with smaller dimming steps it is recommended that the room controller repeats the dimming telegrams automatically (cf. "Telegram repetition").
Transmit stop telegram ?	yes no	For "Yes" the room controller transmits a telegram for stopping the dimming process when the rocker is released. When the room controller transmits telegrams for dimming in smaller steps, the stop telegram is generally not needed.

Telegram repetition?	yes no	This parameter can be used to activate telegram repetition for dimming. With the key held down, the room controller will then transmit the relative dimming telegrams (in the programmed step width) until the key is released.
Time between two telegrams	200 ms 300 ms 400 ms 500 ms 750 ms 1 s 2 s	This parameter defines the interval at which the dimming telegrams are automatically repeated in the telegram repetition mode. Visible only if "Telegram repetition = Yes"!
Full-surface actuation	enabled disabled	When full-surface actuation is enabled, the ETS shows the following parameters.
Function in case of full-surface actuation	Switching scene recall without storage function scene recall with storage function	In case of full-surface operation, this parameter defines the function that is to be used. The ETS shows the corresponding communication object and the other parameters. If the room controller is to recall a scene with storage function by full-surface actuation, it will make a distinction between a brief press (less than 1 s), a sustained press (longer than 5 s) and an invalid key-press (between 1 s and 5 s) A brief press recalls the scene, a sustained press stores a scene and an invalid full-surface actuation is ignored. Visible only if "Full-surface actuation = enabled"!
Command with full-surface actuation	ON OFF TOGGLE	This parameter defines the value of the transmitted telegram a full-surface actuation has been sensed. TOGGLE" switches over the current object value. Visible only if "Function with full-surface actuation = Switching"!
Scene number (1 ... 64)	1, 2, ..., 64	This parameter defines the scene number which is to be transmitted to the bus after a scene recall or during storage of a scene. Visible only if "Function with full-surface actuation = Scene recall"!

If function of the rocker = "Blind/shutter"	<p>Function of status LED at the top</p> <p>always OFF always ON</p> <p>Key-press indication status indicator (LED object) inverted status indicator (LED object) operating mode indicator (KNX controller) controller status indicator (activate controller extension!) comparator without sign (1 byte) comparator with sign (1 byte)</p>	<p>With a blind/shutter function the status LED can...</p> <ul style="list-style-type: none"> • be permanently on or off independent of the communication objects, • signal a key-press, • signal a state of the controller extension, • perform a comparison, • show the state of the own LED object. <p>Depending on this setting, the ETS may also display further LED parameters.</p>
Function of status LED at the bottom	<p>always OFF always ON</p> <p>Key-press indication status indicator (LED object) inverted status indicator (LED object) operating mode indicator (KNX controller) controller status indicator (activate controller extension!) comparator without sign (1 byte) comparator with sign (1 byte)</p>	<p>With a blind/shutter function the status LED can...</p> <ul style="list-style-type: none"> • be permanently on or off independent of the communication objects, • signal a key-press, • signal a state of the controller extension, • perform a comparison, • show the state of the own LED object. <p>Depending on this setting, the ETS may also display further LED parameters.</p>
Command on pressing the rocker	<p>rocker X.1: UP / rocker X.2: DOWN rocker X.1: DOWN / rocker X.2: UP rocker X.1: TOGGLE / rocker X.2: TOGGLE</p>	<p>This parameter defines the running direction of a drive after a key-press. If the setting is "TOGGLE", the direction is changed after each long-time command. If several pushbuttons are to control the same drive, the long-time objects of the pushbuttons must be interlinked for a correct change of the running direction.</p>
Operation concept	<p>Short – long - short long – short: short – long - short long – short:</p>	<p>For shutter control, four different operation concepts can be selected. For these concepts, the ETS shows further parameters.</p>
Time between short-time and long-time command rocker 1.1 (1 ... 3000 x 100 ms)	<p>1 ... 4 ... 3000</p>	<p>This parameter sets the time after which the long-time operation will be evaluated on pressing the top (or left-hand) rocker.</p> <p>This parameter is not visible with "Operation concept = Long – Short"!</p>

<p>Time between short-time and long-time command rocker 1.2 (1 ... 3000 x 100 ms)</p>	<p>1 ... 4 ... 3000</p>	<p>This parameter sets the time after which the long-time operation will be evaluated on pressing the bottom (or right-hand) rocker.</p>
<p>Slat adjustment time rocker 1.1 (0 ... 3000 x 100 ms)</p>	<p>0 ... 5 ... 3000</p>	<p>Time during which a transmitted MOVE telegram can be terminated by releasing the top (or left-hand) key of the rocker (STEP). This function is used for adjustment of the slats of a blind.</p>
<p>Slat adjustment time rocker 1.2 (0 ... 3000 x 100 ms)</p>	<p>0 ... 5 ... 3000</p>	<p>Time during which a transmitted MOVE telegram can be terminated by releasing the bottom (or right-hand) key of the rocker (STEP). This function is used for adjusting the slats of a blind.</p>
<p>Full-surface actuation</p>	<p>enabled disabled</p>	<p>When full-surface actuation is enabled, the ETS shows the following parameters.</p> <p>Full-surface actuation can only be programmed if "Operation concept = Long – Short or Short"!</p>
<p>Function in case of full-surface actuation</p>	<p>Switching scene recall without storage function scene recall with storage function</p>	<p>In case of full-surface operation, this parameter defines the function that is to be used. The ETS shows the corresponding communication object and the other parameters.</p> <p>If the room controller is to recall a scene with storage function by full-surface actuation, it will make a distinction between a brief press (less than 1 s), a sustained press (longer than 5 s) and an invalid key-press (between 1 s and 5 s). A brief press recalls the scene, a sustained press stores a scene and an invalid full-surface actuation is ignored.</p>
		<p>Visible only if "Full-surface actuation = enabled"!</p>

Command with full-surface actuation	ON OFF TOGGLE	This parameter defines the value of the transmitted telegram a full-surface actuation has been sensed. TOGGLE" switches over the current object value.
Scene number (1 ... 64)	1, 2, ..., 64	Visible only if "Function with full-surface actuation = Switching"! This parameter defines the scene number which is to be transmitted to the bus after a scene recall or during storage of a scene.
If function of the rocker = "Value transmitter 1 byte" Function of status LED at the top	always OFF always ON Key-press indication status indicator (LED object) inverted status indicator (LED object) operating mode indicator (KNX controller) controller status indicator (activate controller extension!) comparator without sign (1 byte) comparator with sign (1 byte)	With a value transmitter function the status LED can... <ul style="list-style-type: none">• be permanently on or off independent of the communication objects,• signal a key-press,• signal a state of the controller extension,• perform a comparison,• show the state of the own LED object. Depending on this setting, the ETS may also display further LED parameters.
Function of status LED at the bottom	always OFF always ON Key-press indication status indicator (LED object) inverted status indicator (LED object) operating mode indicator (KNX controller) controller status indicator (activate controller extension!) comparator without sign (1 byte) comparator with sign (1 byte)	With a value transmitter function the status LED can... <ul style="list-style-type: none">• be permanently on or off independent of the communication objects,• signal a key-press,• signal a state of the controller extension,• perform a comparison,• show the state of the own LED object. Depending on this setting, the ETS may also display further LED parameters.

Functionality	<p>rocker X.1 / X.2 no function rocker X.1: 0 ... 255 / rocker X.2: 0 ... 255 rocker X.1: 0 ... 100 % / rocker X.2: 0 ... 100 % rocker X.1: 0 ... 255 / rocker X.2: no function rocker X.1: 0 ... 100 % / rocker X.2: no function rocker X.1: no function / rocker X.2: 0 ... 255 rocker X.1: no function / rocker X.2: 0 ... 100 %</p>	<p>A rocker parameterized as "Value transmitter 1 byte" permits selecting whether the values to be transmitted are interpreted as integers from 0 to 255 or as a percentage from 0 % to 100 % . This decision determines the following parameters and the respective settings.</p>
Value rocker 1.1 (0 ... 255)	0 ... 255	<p>Depending on the "Key arrangement" parameter, this parameter defines the object value, when the top (or left-hand) rocker is pressed.</p> <p>Visible only if "Functionality = ... 0...255"!</p>
Value rocker 1.2 (0 ... 255)	0 ... 255	<p>Depending on the "Key arrangement" parameter, this parameter defines the object value, when the bottom (or right-hand) rocker is pressed.</p> <p>Visible only if "Functionality = ... 0...255"!</p>
Value rocker 1.1 (0 ... 100 %)	0 ... 100	<p>Depending on the "Key arrangement" parameter, this parameter defines the object value, when the top (or left-hand) rocker is pressed.</p> <p>Visible only if "Functionality = ... 0...100 %"!</p>
Value rocker 1.2 (0 ... 100 %)	0 ... 100	<p>Depending on the "Key arrangement" parameter, this parameter defines the object value, when the top (or left-hand) rocker is pressed.</p> <p>Visible only if "Functionality = ... 0...100 %"!</p>
Value variation by long key-press	<p>enabled disabled</p>	<p>If value variation by long key-press is enabled, the ETS shows further parameters. Value variation begins, when the key is being held down for more than 5 s. In this case, the respective status LED blinks as a sign that a new telegram has been transmitted.</p>

Start value for value variation	<p>as specified by parameter</p> <p>same as value after last variation</p> <p>same as value from communication object</p>	<p>Value variation can begin with different starting values.</p> <p>After each long press, the room controller always starts with the value parameterized in the ETS.</p> <p>After a long press, the room controller starts with the value transmitted by itself as the last value.</p> <p>After a long press, the room controller starts with the value transmitted by itself or by another device with this group address as the last value. Visible only if "Value variation by long key-press = enabled"!</p>
Direction of value variation	<p>upwards</p> <p>downwards</p> <p>toggleing (alternating)</p>	<p>With a long press, the room controller can either vary the values always in the same direction or it stores the direction of the last variation and reverses it on the next key-press.</p> <p>Visible only if "Value variation by long key-press = enabled"!</p>
Step width (1 ... 15)	<p>1 ... 15</p>	<p>In a value variation, the room controller determines the new telegram value from the previous value and the preset step width. If the value falls below the lower limit of the variation range (0 or 0 %) or if it exceeds the upper limit (0 or 255%), the sensor adapts the step width of the last step automatically.</p> <p>Visible only if "Value variation by long key-press = enabled"!</p>
Time between two telegrams	<p>0.5 s</p> <p>1 s</p> <p>2 s</p> <p>3 s</p>	<p>This parameter defines the interval at which the room controller transmits new telegrams during a value variation.</p> <p>Visible only if "Value variation by long key-press = enabled"!</p>

Value variation with overflow	yes no	<p>If value variation is to be effected without overflow (setting "no") and if the room controller reaches the lower limit of the variation range (0 or 0 %) or the upper limit (255 or 100 %) during value variation, the variation will be stopped automatically by the sensor. If the value variation with overflow is programmed (setting "yes") and if the pushbutton sensor reaches the lower or the upper limit, it will transmit the value of this range limit and then add a pause the duration of which corresponds to two steps. Thereafter, the room controller sends a telegram with the value of the other range limit and continues to vary the value in the same direction.</p>
If function of the rocker = "Value transmitter 2 byte" Function of status LED at the top	<p>always OFF always ON Key-press indication status indicator (LED object) inverted status indicator (LED object) operating mode indicator (KNX controller) controller status indicator (activate controller extension!) comparator without sign (1 byte) comparator with sign (1 byte)</p>	<p>Visible only if "Value variation by long key-press = enabled"!</p> <p>With a value transmitter function the status LED can...</p> <ul style="list-style-type: none"> • be permanently on or off independent of the communication objects, • signal a key-press, • signal a state of the controller extension, • perform a comparison, • show the state of the own LED object. <p>Depending on this setting, the ETS may also display further LED parameters.</p>
Function of status LED at the bottom	<p>always OFF always ON Key-press indication status indicator (LED object) inverted status indicator (LED object) operating mode indicator (KNX controller) controller status indicator (activate controller extension!) comparator without sign (1 byte) comparator with sign (1 byte)</p>	<p>With a value transmitter function the status LED can...</p> <ul style="list-style-type: none"> • be permanently on or off independent of the communication objects, • signal a key-press, • signal a state of the controller extension, • perform a comparison, • show the state of the own LED object. <p>Depending on this setting, the ETS may also display further LED parameters.</p>

Functionality	Temperature value transmitter Brightness value transmitter value transmitter (0 ... 65535)	A rocker parameterized as "Value transmitter 1 byte" permits selecting whether the values to be transmitted are to be interpreted as temperature values (0 °C to 40 °C), as brightness values (0 lux to 1500 lux) or as integers (0 to 65535). The following parameters and their settings depend on this distinction.
Temperature value (0 ... 40 °C) rocker 1.1	0 ... 20 ... 40	<p>Depending on the "Key arrangement" parameter, this parameter defines the object value, when the top (or left-hand) rocker is pressed.</p> <p>Visible only if "Functionality = Temperature value transmitter"!</p>
Temperature value (0 ... 40 °C) rocker 1.2	0 ... 20 ... 40	<p>Depending on the "Key arrangement" parameter, this parameter defines the object value, when the bottom (or right-hand) rocker is pressed.</p> <p>Visible only if "Functionality = Temperature value transmitter"!</p>
Brightness value rocker 1.1	0, 50, ... 300 ... 1450, 1500 lux	<p>Depending on the "Key arrangement" parameter, this parameter defines the object value, when the top (or left-hand) rocker is pressed.</p> <p>Visible only if "Functionality = Brightness value transmitter"!</p>
Brightness value rocker 1.2	0, 50, ... 300 ... 1450, 1500 lux	<p>Depending on the "Key arrangement" parameter, this parameter defines the object value, when the bottom (or right-hand) rocker is pressed.</p> <p>Visible only if "Functionality = Brightness value transmitter"!</p>
Value (0 ... 65535) rocker 1.1	0 ... 65535	<p>Depending on the "Key arrangement" parameter, this parameter defines the object value, when the top (or left-hand) rocker is pressed.</p> <p>Visible only if "Functionality = Value transmitter (0 ... 65535)"!</p>
Value (0 ... 65535) rocker 1.2	0 ... 65535	<p>Depending on the "Key arrangement" parameter, this parameter defines the object value, when the bottom (or right-hand) rocker is pressed.</p> <p>Visible only if "Functionality = Value transmitter (0 ... 65535)"!</p>

Value variation by long key-press	<p>enabled disabled</p>	<p>If value variation by long key-press is enabled, the ETS shows further parameters. Value variation begins, when the key is being held down for more than 5 s. In this case, the respective status LED blinks as a sign that a new telegram has been transmitted.</p>
Start value for value variation	as specified by parameter	<p>Value variation can begin with different starting values.</p> <p>After each long press, the room controller always starts with the value parameterized in the ETS.</p>
	same as value after last variation	<p>After a long press, the room controller starts with the value transmitted by itself as the last value.</p>
	same as value from communication object	<p>After a long press, the room controller starts with the value transmitted by itself or by another device with this group address as the last value. *</p> <p>Visible only if "Value variation by long key-press = enabled"!</p> <p>*: This setting selectable only if "Functionality = Value transmitter (0...65535)!"</p>
Direction of value variation	<p>upwards downwards toggle (alternating)</p>	<p>With a long press, the room controller can either vary the values always in the same direction or it stores the direction of the last variation and reverses it on the next key-press.</p> <p>Visible only if "Value variation by long key-press = enabled"!</p>
Step size	1 °C	<p>For temperature values, the step size of the variation is fixed to 1°C.</p> <p>Visible only if "Functionality = Temperature value transmitter" and "Value variation by long key-press = enabled"!</p>
Step size	50 lux	<p>For brightness values, the step size of the variation is fixed to 50 lux.</p> <p>Visible only if "Functionality = Brightness value transmitter" and "Value variation by long key-press = enabled"!</p>

Step size	1	This parameter sets the step size of the value variation for the 2-byte value transmitter. Visible only if "Functionality = Temperature value transmitter" and "Value variation by long key-press = enabled"!
	2	
	5	
	10	
	20	
	50	
	75	
	100	
	200	
	500	
750		
1000		
Time between two telegrams	0.5 s	This parameter defines the interval at which the room controller transmits new telegrams during a value variation. Visible only if "Value variation by long key-press = enabled"!
	1 s	
	2 s	
	3 s	
Value variation with overflow	yes no	If value variation is to be effected without overflow (setting "No") and if the room controller reaches the lower limit of the variation range (0°C, 0 lux, 0) or the upper limit (+40°C, 1500 lux, 65535) during value variation, the variation will be stopped automatically by the sensor. If the value variation with overflow is programmed (setting "yes") and if the room controller reaches the lower or the upper limit, it will transmit the value of this range limit and then add a pause the duration of which corresponds to two steps. Thereafter, the room controller sends a telegram with the value of the other range limit and continues to vary the value in the same direction.
If function of the rocker = "Scene extension"		
Function of status LED at the top	always OFF	With a scene extension function the status LED can... <ul style="list-style-type: none"> • be permanently on or off independent of the communication objects, • signal a key-press, • signal a state of the controller extension, • perform a comparison, • show the state of the own LED object. Depending on this setting, the ETS may also display further LED parameters.
	always ON	
	Key-press indication	
	status indicator (LED object)	
	inverted status indicator (LED object)	
	operating mode indicator (KNX controller)	
	controller status indicator (activate controller extension!)	
	comparator without sign (1 byte)	
	comparator with sign (1 byte)	

Function of status LED at the bottom	<p>always OFF always ON Key-press indication status indicator (LED object) inverted status indicator (LED object) operating mode indicator (KNX controller) controller status indicator (activate controller extension!) comparator without sign (1 byte) comparator with sign (1 byte)</p>	<p>With a scene extension function the status LED can...</p> <ul style="list-style-type: none"> • be permanently on or off independent of the communication objects, • signal a key-press, • signal a state of the controller extension, • perform a comparison, • show the state of the own LED object. <p>Depending on this setting, the ETS may also display further LED parameters.</p>
Functionality	<p>Scene extension without storage function Scene extension with storage function Recall of internal scene without storage function Recall of internal scene with storage function</p>	<p>This parameter defines the functionality of the extension.</p> <p>If the room controller is used as scene extension, the scenes can either be stored in one or in several other KNX/EIB devices (e.g. light scene pushbutton sensor). During a scene recall or in a storage function, the room controller transmits a telegram with the respective scene number via the extension object of the rocker.</p> <p>During the recall of an internal scene, a scene stored internally in the room controller Universal TSM is recalled or stored again. No telegram will be transmitted to the bus via a scene extension object. For this setting, the internal scene function must be enabled.</p>
Scene number (1 ... 64) rocker 1.1	1 ... 64	<p>In accordance with the KNX standard, objects with data type 18.001 "Scene Control" can recall or store up to 64 scenes by their numbers. The parameter defines the scene number to be transmitted when the top (or left) of the key is pressed.</p>
Scene number (1 ... 64) rocker 1.2	1 ... 64	<p>In accordance with the KNX standard, objects with data type 18.001 "Scene Control" can recall or store up to 64 scenes by their numbers. The parameter defines the scene number to be transmitted when the bottom (or right) of the key is pressed.</p>
Scene number (1 ... 8) rocker 1.1	1 ... 8	<p>This parameter defines the number of the internal scene which is recalled or stored when the top (or left) of the key is pressed.</p>
Scene number (1 ... 8) rocker 1.2	1 ... 8	<p>This parameter defines the number of the internal scene which is recalled or stored when the bottom (or right) of the key is pressed.</p>

<p>If function of the rocker = "switching" Function of status LED at the top</p>	<p>always OFF always ON telegram acknowledge status indicator (LED object) inverted status indicator (LED object) operating mode indicator (KNX controller) controller status indicator (activate controller extension!) comparator without sign (1 byte) comparator with sign (1 byte)</p>	<p>With a 2-channel function, the status LED can...</p> <ul style="list-style-type: none"> • be permanently on or off independent of the communication objects, • indicate whether a telegram has been transmitted, • signal a state of the controller extension, • perform a comparison, • show the state of the own LED object. <p>Depending on this setting, the ETS may also display further LED parameters.</p>
<p>Function of status LED at the bottom</p>	<p>always OFF always ON telegram acknowledge status indicator (LED object) inverted status indicator (LED object) operating mode indicator (KNX controller) controller status indicator (activate controller extension!) comparator without sign (1 byte) comparator with sign (1 byte)</p>	<p>With a 2-channel function, the status LED can...</p> <ul style="list-style-type: none"> • be permanently on or off independent of the communication objects, • indicate whether a telegram has been transmitted, • signal a state of the controller extension, • perform a comparison, • show the state of the own LED object. <p>Depending on this setting, the ETS may also display further LED parameters.</p>
<p>Operation concept</p>	<p>channel 1 or channel 2 channel 1 and channel 2</p>	<p>This parameter defines the 2-channel operation concept. If the setting "Channel 1 or channel 2" is selected, the room controller decides dependent on the key-press duration which of the channels will be used. If the setting "Channel 1 and channel 2" is selected, the pushbutton sensor transmits only the telegram of channel 1 on a short key-press and both telegrams on a sustained key-press.</p>
<p>Function channel 1 (2)</p>	<p>no function switching (1 bit) value transmitter 0 ... 255 (1 byte) value transmitter 0 ... 100 % (1 byte) temperature value transmitter (2 bytes)</p>	<p>This parameter defines the channel function and specifies which other parameters and which communication object are to be displayed for channel 1 (2).</p>
<p>Key command for channel 1 (2) rocker 1.1</p>	<p>ON OFF TOGGLE</p>	<p>This parameter defines the object value transmitted to the bus, when the top (or left-hand) rocker is pressed.</p> <p>Visible only if "Function channel 1 (2) = Switching (1 bit)"!</p>

Key command for channel 1 (2) rocker 1.2	ON OFF TOGGLE	This parameter defines the object value transmitted to the bus, when the bottom (or right-hand) rocker is pressed. Visible only if "Function channel 1 (2) = Switching (1 bit)"!
Value of key for channel 1 (2) rocker 1.1 (0 ... 255)	0 ... 255	This parameter defines the object value transmitted to the bus, when the top (or left-hand) rocker is pressed. Visible only if "Function channel 1 (2) = Value transmitter 0...255 (1 byte)"!
Value of key for channel 1 (2) rocker 1.2 (0 ... 255)	0 ... 255	This parameter defines the object value transmitted to the bus, when the bottom (or right-hand) rocker is pressed. Visible only if "Function channel 1 (2) = Value transmitter 0...255 (1 byte)"!
Value of key for channel 1 (2) rocker 1.1 (0 ... 100 %)	0 ... 100	This parameter defines the object value transmitted to the bus, when the top (or left-hand) rocker is pressed. Visible only if "Function channel 1 (2) = Value transmitter 0...100 % (1 byte)"!
Value of key for channel 1 (2) rocker 1.2 (0 ... 100 %)	0 ... 100	This parameter defines the object value transmitted to the bus, when the bottom (or right-hand) rocker is pressed. Visible only if "Function channel 1 (2) = Value transmitter 0...100 % (1 byte)"!
Temperature value of key for channel 1 (2) rocker 1.1 (0 ... 40 °C)	0 ... 40	This parameter defines the temperature value transmitted to the bus, when the top (or left-hand) rocker is pressed. Visible only if "Function channel 1 (2) = Temperature value transmitter (2 bytes)"!
Temperature value of key for channel 1 (2) rocker 1.2 (0 ... 40 °C)	0 ... 40	This parameter defines the temperature value transmitted to the bus, when the bottom (or right-hand) rocker is pressed. Visible only if "Function channel 1 (2) = Temperature value transmitter (2 bytes)"!
Time between channel 1 and channel 2 rocker 1.1 (1 ... 255 x 100 ms)	0 ... 30 ... 255	Depending on the selected operation concept, this parameter defines the interval at which the sensor transmits the telegram for channel 1 and the telegram for channel 2 when the top (or left side) of the rocker is pressed.

Time between channel 1 and channel 2 rocker 1.2 (1 ... 255 x 100 ms)	0 ... 30 ... 255	Depending on the selected operation concept, this parameter defines the interval at which the sensor transmits the telegram for channel 1 and the telegram for channel 2 if the bottom (or right side) of the rocker is pressed.
Full-surface actuation	enabled disabled	When full-surface actuation is enabled, the ETS shows the following parameters. Full-surface actuation can only be programmed if "Operation concept = Channel 1 or channel 2"!
Function in case of full-surface actuation	Switching scene recall without storage function scene recall with storage function	In case of full-surface operation, this parameter defines the function that is to be used. The ETS shows the corresponding communication object and the other parameters. If the room controller is to recall a scene with storage function by full-surface actuation, it will make a distinction between a brief press (less than 1 s), a sustained press (longer than 5 s) and an invalid key-press (between 1 s and 5 s) A brief press recalls the scene, a sustained press stores a scene and an invalid full-surface actuation is ignored. Visible only if "Full-surface actuation = enabled"!
Command with full-surface actuation	ON OFF TOGGLE	This parameter defines the value of the transmitted telegram a full-surface actuation has been sensed. TOGGLE" switches over the current object value. Visible only if "Function with full-surface actuation = Switching"!
Scene number (1 ... 64)	1, 2, ..., 64	This parameter defines the scene number which is to be transmitted to the bus after a scene recall or during storage of a scene. Visible only if "Function with full-surface actuation = Scene recall"!

 Rocker 2 see rocker 1!

 Key 1 (only if "Function of keys 1 and 2 = as separate keys"!)		
Function	no function Switching Dimming blind Value transmitter 1 byte Value transmitter 2 bytes Scene extension 2-channel operation Controller extension (-> "room temperature control") Fan control: Info key: Page changing: Operating mode switch-over setpoint value shift	This parameter defines the basic function of the key. Depending on this setting, the ETS displays different communication objects and parameters for this key.
Info text line 2	info text Z2 W1	The text entered here is displayed when a rocker is pressed.
Info text line 3	predefined text (depending on key function) free text	Depending on the programmed function of the key, different texts are predefined for the third line in the device software. As an option, also free texts can be entered. In diesem Fall zeigt die ETS den nächsten Parameter an.
Info text line 3	info text L3 top/left	The text entered here is displayed when a rocker is pressed. The text can be edited at the user's discretion and may consist of 18 characters max.

<p>The status LEDs of a key can be programmed for independent LED functions which have no relationship with the basic function of the key. This always results in the LED parameters described below.</p> <p>If the function of the status LED = "Operating mode indicator (KNX controller)"</p>		
Status LED ON with	<p>automatic mode</p> <p>comfort operation</p> <p>standby mode</p> <p>night-time operation</p> <p>frost /heat protection</p>	<p>The values of a communication object with data type 20.102 "HVAC Mode" are defined as follows:</p> <p>0 = automatic</p> <p>1 = comfort</p> <p>2 = standby</p> <p>3 = night-time</p> <p>4 = frost/ heat protection</p> <p>The value "automatic" is used only by the "forced operating mode switch-over" objects</p> <p>The status LED is on when the object adopts the parameterized value.</p>
<p>If the function of the status LED = "Controller status indicator"</p>		
Status LED ON with	<p>comfort operation</p> <p>standby mode</p> <p>night-time operation</p> <p>frost /heat protection</p> <p>Controller disabled</p> <p>Heating / cooling</p> <p>controller inactive (dead zone operation)</p> <p>Frost alarm</p>	<p>The "Controller status" communication object of the controller extension function includes eight bits of information in one byte. This parameter defines which bit is to be indicated by the LED.</p> <p>The controller status can be displayed only if the controller extension is enabled (parameter page "General")!</p>
<p>If the function of the status LED = "Comparator without sign"</p>		
Status LED ON with	<p>reference value greater than received value</p> <p>reference value less than received value</p> <p>reference value equal to received value</p>	<p>The status LED indicates whether the parameterized reference value is greater or less than or equal to the value of the "Status LED" object.</p>
Reference value (0 ... 255)	<p>0 ... 255</p>	<p>This parameter defines the reference value to which the value of the "Status LED" object is compared.</p>
<p>If the function of the status LED = "Comparator with sign"</p>		
Status LED ON with	<p>reference value greater than received value</p> <p>reference value less than received value</p> <p>reference value equal to received value</p>	<p>The status LED indicates whether the parameterized reference value is greater or less than or equal to the value of the "Status LED" object.</p>
Reference value (-128 ... 127)	<p>-128 ... 0 ... 127</p>	<p>This parameter defines the reference value to which the value of the "Status LED" object is compared.</p>

If function of the key = "No function"	<p>Function of status LED</p> <p>always OFF always ON status indicator (LED object) inverted status indicator (LED object) operating mode indicator (KNX controller) controller status indicator (activate controller extension!) comparator without sign (1 byte) comparator with sign (1 byte)</p>	<p>When the rocker is not used, the status LED can ...</p> <ul style="list-style-type: none"> • be permanently on or off independent of the communication objects, • signal a state of the controller extension, • perform a comparison, • show the state of the own LED object. <p>Depending on this setting, the ETS may also display further LED parameters.</p>
If function of the rocker = "Switching"	<p>Function of status LED</p> <p>always OFF always ON Key-press indication status indicator (switching object) inverted status indicator (switching object) status indicator (LED object) inverted status indicator (LED object) operating mode indicator (KNX controller) controller status indicator (activate controller extension!) comparator without sign (1 byte) comparator with sign (1 byte)</p>	<p>With a switching function the status LED can...</p> <ul style="list-style-type: none"> • be permanently on or off independent of the communication objects, • signal a key-press, • signal the state of the communication object "Switching" • signal a state of the controller extension, • perform a comparison, • show the state of the own LED object. <p>Depending on this setting, the ETS may also display further LED parameters.</p>
Command on pressing the key	<p>no reaction ON OFF TOGGLE</p>	<p>Depending on the "Key arrangement" parameter, these parameters define the reaction taking place when the key is pressed or released.</p>
Command on releasing the key	<p>no reaction ON OFF TOGGLE</p>	

If function of the key = "Dimming"		
Function of status LED	<p>always OFF always ON</p> <p>Key-press indication status indicator (switching object) inverted status indicator (switching object) status indicator (LED object) inverted status indicator (LED object) operating mode indicator (KNX controller) controller status indicator (activate controller extension!) comparator without sign (1 byte) comparator with sign (1 byte)</p>	<p>With a dimming function the status LED can...</p> <ul style="list-style-type: none"> • be permanently on or off independent of the communication objects, • signal a key-press, • signal the state of the communication object "Switching" • signal a state of the controller extension, • perform a comparison, • show the state of the own LED object. <p>Depending on this setting, the ETS may also display further LED parameters.</p>
Command on pressing the key	<p>no reaction Brighter (ON) Darker (OFF) brighter / darker (TOGGLE) brighter (TOGGLE) darker (TOGGLE)</p>	<p>This parameter defines the reaction when the key is pressed.</p> <p>If the room controller is to toggle on a brief press, the corresponding switching objects of other sensors with the same function must be linked with one another. In the "Brighter/darker (TOGGLE)" setting, the dimming objects must be interlinked as well so that the room controller can send the correct telegram on the next key-press.</p>
Time between switching and dimming (100 ... 50000 x 1 ms)	100 ... 400 ... 50000	<p>This parameter defines how long the key must be pressed for the room controller to send a dimming telegram.</p>

Advanced parameters	activated deactivated	When the advanced parameters are activated, the ETS shows the following parameters.
Advanced parameters activated...		
Increase brightness by	1,5 % 3 % 6 % 12,5 % 25 % 50 % 100 %	This parameter sets the relative dimming step when the brightness is increased. On each key-press, the brightness is changed at maximum by the parameterized step Especially with smaller dimming steps it is recommended that the room controller repeats the dimming telegrams automatically (cf. "Telegram repetition").
Reduce brightness by	1,5 % 3 % 6 % 12,5 % 25 % 50 % 100 %	This parameter sets the relative dimming step when the brightness is reduced. On each key-press, the brightness is changed at maximum by the parameterized step Especially with smaller dimming steps it is recommended that the room controller repeats the dimming telegrams automatically (cf. "Telegram repetition").
Transmit stop telegram ?	yes no	For "yes" the room controller transmits a telegram for stopping the dimming process when the key is released. Wenn der Raum-Controller Telegramme zum Dimmen in kleinen Stufen sendet, wird das Stoptelegramm in der Regel nicht benötigt.
Telegram repetition?	yes no	This parameter can be used to activate telegram repetition for dimming. With the key held down, the room controller will then transmit the relative dimming telegrams (in the programmed step width) until the key is released.
Time between two telegrams	200 ms 300 ms 400 ms 500 ms 750 ms 1 s 2 s	This parameter defines the interval at which the dimming telegrams are automatically repeated in the telegram repetition mode. Visible only if "Telegram repetition = Yes"!

If function of the key = "Blind/shutter"		
Function of status LED	<p>always OFF always ON</p> <p>Key-press indication status indicator (LED object) inverted status indicator (LED object) operating mode indicator (KNX controller) controller status indicator (activate controller extension!) comparator without sign (1 byte) comparator with sign (1 byte)</p>	<p>With a blind/shutter function the status LED can...</p> <ul style="list-style-type: none"> • be permanently on or off independent of the communication objects, • signal a key-press, • signal a state of the controller extension, • perform a comparison, • show the state of the own LED object. <p>Depending on this setting, the ETS may also display further LED parameters.</p>
Command on pressing the key	<p>DOWN UP TOGGLE</p>	<p>This parameter defines the running direction of a drive after a key-press. If the setting is "TOGGLE", the direction is changed after each long-time command. If several pushbuttons are to control the same drive, the long-time objects of the pushbuttons must be interlinked for a correct change of the running direction.</p>
Operational sequence	<p>Short – long - short long – short: short – long - short long – short:</p>	<p>For shutter control, four different operation concepts can be selected. For these concepts, the ETS shows further parameters.</p>
Time between short-time and long-time command (1 ... 3000 x 100 ms)	<p>1 ... 4 ... 3000</p>	<p>This parameter sets the time after which the long-time operation will be evaluated on pressing the key.</p> <p>This parameter is not visible with "Operation concept = Long – Short"!</p>
Slat adjustment time (0 ... 3000 x 100 ms)	<p>0 ... 5 ... 3000</p>	<p>Time during which a transmitted MOVE telegram can be terminated by releasing the key (STEP). This function is used for adjusting the slats of a blind.</p> <p>This parameter is not visible with "Operation concept = Long – Short"!</p>

<p>If function of the key = "Value transmitter 1 byte" Function of status LED</p>	<p>always OFF always ON Key-press indication status indicator (LED object) inverted status indicator (LED object) operating mode indicator (KNX controller) controller status indicator (activate controller extension!) comparator without sign (1 byte) comparator with sign (1 byte)</p>	<p>With a value transmitter function the status LED can...</p> <ul style="list-style-type: none"> • be permanently on or off independent of the communication objects, • signal a key-press, • signal a state of the controller extension, • perform a comparison, • show the state of the own LED object. <p>Depending on this setting, the ETS may also display further LED parameters.</p>
<p>Functionality</p>	<p>value transmitter 0 ... 255 value transmitter 0 ... 100 %</p>	<p>A key parameterized as "Value transmitter 1 byte" permits selecting whether the values to be transmitted are interpreted as integers from 0 to 255 or as a percentage from 0 % to 100 %. The following parameters and their settings depend on this distinction.</p>
<p>Value (0 ... 255)</p>	<p>0 ... 255</p>	<p>This parameter defines the object value, when the key is pressed.</p> <p>Visible only if "Functionality = ... 0...255"!</p>
<p>Value (0 ... 100 %)</p>	<p>0 ... 100</p>	<p>This parameter defines the object value, when the key is pressed.</p> <p>Visible only if "Functionality = ... 0...100 %"!</p>
<p>Value variation by long key-press</p>	<p>enabled disabled</p>	<p>If value variation by long key-press is enabled, the ETS shows further parameters. Value variation begins, when the key is being held down for more than 5 s. In this case, the respective status LED blinks as a sign that a new telegram has been transmitted.</p>

Start value for value variation	as specified by parameter	Value variation can begin with different starting values.
	same as value after last variation	After each long press, the room controller always starts with the value parameterized in the ETS.
	same as value from communication object	After a long press, the room controller starts with the value transmitted by itself as the last value.
		After a long press, the room controller starts with the value transmitted by itself or by another device with this group address as the last value.
		Visible only if "Value variation by long key-press = enabled"!
Direction of value variation	upwards downwards toggle (alternating)	With a long press, the room controller can either vary the values always in the same direction or it stores the direction of the last variation and reverses it on the next key-press.
		Visible only if "Value variation by long key-press = enabled"!
Step width (1 ... 15)	1 ... 15	In a value variation, the room controller determines the new telegram value from the previous value and the preset step width. If the value falls below the lower limit of the variation range (0 or 0 %) or if it exceeds the upper limit (255 or 100%), the controller adapts the step width of the last step automatically.
		Visible only if "Value variation by long key-press = enabled"!
Time between two telegrams	0.5 s 1 s 2 s 3 s	This parameter defines the interval at which the room controller transmits new telegrams during a value variation.
		Visible only if "Value variation by long key-press = enabled"!

Value variation with overflow	yes no	<p>If value variation is to be effected without overflow (setting "no") and if the room controller reaches the lower limit of the variation range (0 or 0 %) or the upper limit (255 or 100 %) during value variation, the variation will be stopped automatically by the controller.</p> <p>If the value variation with overflow is programmed (setting "yes") and if the room controller reaches the lower or the upper limit, it will transmit the value of this range limit and then add a pause the duration of which corresponds to two steps. Thereafter, the room controller transmits a telegram with the value of the other range limits and continues the value variation in the same direction.</p>
If function of the key = "Value transmitter 2 bytes" Function of status LED	<p>always OFF always ON</p> <p>Key-press indication status indicator (LED object) inverted status indicator (LED object) operating mode indicator (KNX controller) controller status indicator (activate controller extension!) comparator without sign (1 byte) comparator with sign (1 byte)</p>	<p>Visible only if "Value variation by long key-press = enabled"!</p> <p>With a value transmitter function the status LED can...</p> <ul style="list-style-type: none"> • be permanently on or off independent of the communication objects, • signal a key-press, • signal a state of the controller extension, • perform a comparison, • show the state of the own LED object. <p>Depending on this setting, the ETS may also display further LED parameters.</p>
Functionality	<p>temperature value transmitter brightness value transmitter value transmitter (0 ... 65535)</p>	<p>A key parameterized as "Value transmitter 1 byte" permits selecting whether the values to be transmitted are to be interpreted as temperature values (0 °C to 40 °C), as brightness values (0 lux to 1500 lux) or as integers (0 to 65535). The following parameters and their settings depend on this distinction.</p>
Temperature value (0 ... 40 °C)	0 ... 20 ... 40	<p>This parameter defines the object value, when the key is pressed.</p> <p>Visible only if "Functionality = Temperature value transmitter"!</p>
Brightness value	0, 50, ... 300 ... 1450, 1500 lux	<p>This parameter defines the object value, when the key is pressed.</p> <p>Visible only if "Functionality = Brightness value transmitter"!</p>

Value (0 ... 65535)	0 ... 65535	<p>This parameter defines the object value, when the key is pressed.</p> <p>Visible only if "Functionality = Value transmitter (0 ... 65535)"!</p>
Value variation by long key-press	<p>enabled</p> <p>disabled</p>	<p>If value variation by long key-press is enabled, the ETS shows further parameters. Value variation begins, when the key is being held down for more than 5 s. In this case, the respective status LED blinks as a sign that a new telegram has been transmitted.</p>
Start value for value variation	<p>as specified by parameter</p> <p>same as value after last variation</p> <p>same as value from communication object *</p>	<p>Value variation can begin with different start values.</p> <p>After each long press, the room controller always starts with the value parameterized in the ETS.</p> <p>After a long press, the room controller starts with the value transmitted by itself as the last value.</p> <p>After a long press, the room controller starts with the value transmitted by itself or by another device with this group address as the last value.</p> <p>*</p> <p>Visible only if "Value variation by long key-press = enabled"!</p> <p>*: This setting selectable only if "Functionality = Value transmitter (0...65535)"!</p>
Direction of value variation	<p>upwards</p> <p>downwards</p> <p>toggle (alternating)</p>	<p>With a long press, the room controller can either vary the values always in the same direction or it stores the direction of the last variation and reverses it on the next key-press.</p> <p>Visible only if "Value variation by long key-press = enabled"!</p>
Step size	1 °C	<p>For temperature values, the step size of the variation is fixed to 1°C.</p> <p>Visible only if "Functionality = Temperature value transmitter" and "Value variation by long key-press = enabled"!</p>
Step size	50 lux	<p>For brightness values, the step size of the variation is fixed to 50 lux.</p> <p>Visible only if "Functionality = Brightness value transmitter" and "Value variation by long key-press = enabled"!</p>

Step size	1	This parameter sets the step size of the value variation for the 2-byte value transmitter. Visible only if "Functionality = Temperature value transmitter" and "Value variation by long key-press = enabled"!
	2	
	5	
	10	
	20	
	50	
	75	
	100	
	200	
	500	
750		
1000		
Time between two telegrams	0.5 s	This parameter defines the interval at which the room controller transmits new telegrams during a value variation. Visible only if "Value variation by long key-press = enabled"!
	1 s	
	2 s	
	3 s	
Value variation with overflow	yes no	If value variation is to be effected without overflow (setting "no") and if the room controller reaches the lower limit of the variation range (0°C, 0 lux, 0) or the upper limit (+40°C, 1500 lux, 65535) during value variation, the variation will be stopped automatically by the controller. If the value variation with overflow is programmed (setting "yes") and if the room controller reaches the lower or the upper limit, it will transmit the value of this range limit and then add a pause the duration of which corresponds to two steps. Thereafter, the room controller transmits a telegram with the value of the other range limits and continues the value variation in the same direction.
If function of the rocker = "Scene extension"		
Function of status LED	always OFF always ON key-press indicator status indicator (LED object) inverted status indicator (LED object) operating mode indicator (KNX controller) controller status indicator (activate controller extension!) comparator without sign (1 byte) comparator with sign (1 byte)	With a scene extension function the status LED can... <ul style="list-style-type: none">• be permanently on or off independent of the communication objects,• signal a key-press,• signal a state of the controller extension,• perform a comparison,• show the state of the own LED object. Depending on this setting, the ETS may also display further LED parameters.

<p>Functionality</p>	<p>Scene extension without storage function Scene extension with storage function Recall of internal scene without storage function Recall of internal scene with storage function</p>	<p>This parameter defines the functionality of the extension. If the room controller is used as scene extension, the scenes can either be stored in one or in several other KNX/EIB devices (e.g. light scene room controller).</p> <p>during a scene recall or in a storage function, the room controller transmits a telegram with the respective scene number via the extension object of the rocker. During the recall of an internal scene, a scene stored internally in the room controller is recalled or stored again. In this case, the sensor transmits no telegram to the bus via a scene extension object. For this setting, the internal scene function must be enabled.</p>
<p>Scene number (1 ... 64)</p>	<p>1 ... 64</p>	<p>In accordance with the KNX standard, objects with data type 18.001 "Scene Control" can recall or store up to 64 scenes by their numbers. The parameter defines the scene number to be transmitted when a key is pressed.</p>
<p>Scene number (1 ... 8)</p>	<p>1 ... 8</p>	<p>This parameter defines the number of the internal scene which is recalled or stored when a key is pressed.</p>
<p>If function of the rocker = "Switching" Function of status LED</p>	<p>always OFF always ON telegram acknowledge status indicator (LED object) inverted status indicator (LED object) operating mode indicator (KNX controller) controller status indicator (activate controller extension!) comparator without sign (1 byte) comparator with sign (1 byte)</p>	<p>With a 2-channel function, the status LED can...</p> <ul style="list-style-type: none"> • be permanently on or off independent of the communication objects, • indicate whether a telegram has been transmitted, • signal a state of the controller extension, • perform a comparison, • show the state of the own LED object. <p>Depending on this setting, the ETS may also display further LED parameters.</p>
<p>Operating concept</p>	<p>channel 1 or channel 2 channel 1 and channel 2</p>	<p>This parameter defines the 2-channel operating concept. If the setting "Channel 1 or channel 2" is selected, the room controller decides dependent on the key-press duration which of the channels will be used. If the setting "Channel 1 and channel 2" is selected, the device transmits only the telegram of channel 1 on a short key-press and both telegrams on a sustained key-press.</p>

Function channel 1 (2)	no function switching (1 bit) value transmitter 0 ... 255 (1 byte) value transmitter 0 ... 100 % (1 byte) temperature value transmitter (2 bytes)	This parameter defines the channel function and specifies which other parameters and which communication object are to be displayed for channel 1 (2).
Command of key for channel 1 (2)	ON OFF TOGGLE	This parameter defines the object value transmitted to the bus, when the key is pressed. Visible only if "Function channel 1 (2) = Switching (1 bit)"!
Value of key for channel 1 (2) (0 ... 255)	0 ... 255	This parameter defines the object value transmitted to the bus, when the key is pressed. Visible only if "Function channel 1 (2) = Value transmitter 0...255 (1 byte)"!
Value of key for channel 1 (2) (0 ... 100 %)	0 ... 100	This parameter defines the object value transmitted to the bus, when the key is pressed. Visible only if "Function channel 1 (2) = Value transmitter 0...100 % (1 byte)"!
Temperature value of key for channel 1 (2) (0 ... 40 °C)	0 ... 40	This parameter defines the temperature value transmitted to the bus, when the key is pressed. Visible only if "Function channel 1 (2) = Temperature value transmitter (2 bytes)"!
Time between channel 1 und channel 2 (1 ... 255 x 100 ms)	0 ... 30 ... 255	Depending on the selected operating concept, this parameter defines the interval at which the sensor transmits the telegram for channel 1 and the telegram for channel 2 when the key is pressed.

If function of the key = "Controller extension"	<p>Function of status LED</p> <p>always OFF always ON</p> <p>key-press indicator status indicator (LED object) inverted status indicator (LED object) key function active indicator * key function inactive indicator * setpoint value shift indicator ** operating mode indicator (KNX controller) controller status indicator (activate controller extension!) comparator without sign (1 byte) comparator with sign (1 byte)</p>	<p>With a controller extension function the status LED can...</p> <ul style="list-style-type: none"> • be permanently on or off independent of the communication objects, • signal a key-press, • signal a state of the controller extension, • perform a comparison, • show the state of the own LED object. • signal the presence state (key function indication) * • indicate a setpoint value shift ** <p>Depending on this setting, the ETS may also display further LED parameters.</p> <p>*: The key function indication can only be programmed with a presence key!</p> <p>** : The setpoint value shift can only be programmed, if the key functionality is set to "Setpoint value shift".</p>
Status LED	<p>ON with variation ON with positive variation ON with negative variation OFF with variation OFF with positive variation OFF with negative variation</p>	<p>With a setpoint shift indication, the illumination behaviour of the status LED can be adjusted.</p> <p>If the setting is "ON...", the status LED is on only in case of a variation. Otherwise, it is permanently off.</p> <p>If the setting is "OFF...", the status LED switches off in case of a variation. Otherwise, it is permanently on.</p> <p>One can also specify whether the status LED is to be switched whenever a variation occurs or only in case of a positive or alternatively a negative setpoint variation.</p> <p>Visible only if "Function of the status LED = Setpoint value shift indication"!</p>
Functionality	<p>Operating mode switch-over forced operating mode switchover Presence key setpoint value shift</p>	<p>A controller extension can optionally switch over the operating mode with normal or high priority, change the presence state or change the current room temperature value. With regard to the setting of this parameter, the ETS shows further parameters.</p>

<p>Operating mode on pressing the key</p>	<p>comfort operation standby mode night-time operation frost /heat protection comfort operation -> standby operation -> comfort operation -> night-time operation -> standby operation -> night-time operation -> comfort operation -> standby operation -> night-time operation -></p>	<p>If the controller extension is to switch over the operating mode of the room temperature controller with normal priority, the extension can – when actuated – either activate a defined mode of operation or change over between different modes of operation.</p> <p>In order for this change to work properly, the controller extension should request the current state of the extension objects after a reset or after reprogramming (set parameter under "General" to "Value request from controller extension = Yes").</p> <p>Visible only if "Functionality = Operating mode switch-over"!</p>
<p>Forced operating mode on pressing the key</p>	<p>auto (normal operating mode switch-over) comfort operation standby mode night-time operation frost /heat protection comfort operation -> standby operation -> comfort operation -> night-time operation -> standby operation -> night-time operation -> comfort operation -> standby operation -> night-time operation -> auto -> comfort operation -> auto -> standby operation -></p>	<p>If the controller extension is to switch over the operating mode of the room temperature controller with high priority, the extension can – when actuated – either enable the switch-over with normal priority (auto), switch on a defined mode of operation with a high priority or change over between different modes of operation.</p> <p>In order for this change to work properly, the controller extension should request the current state of the extension objects after a reset or after reprogramming (set parameter under "General" to "Value request from controller extension = yes").</p> <p>Visible only if "Functionality = Forced operating mode switch-over"!</p>
<p>Presence function on pressing the key</p>	<p>presence OFF presence ON presence TOGGLE</p>	<p>On pressing a key, the controller extension can switch the presence state of the room temperature controller either on or off in a defined way or change over between both states ("Presence TOGGLE").</p> <p>In order for this change to work properly, the controller extension should request the current state of the extension objects after a reset or after reprogramming (set parameter under "General" to "Value request from controller extension = yes").</p>

<p>"Setpoint shift" functionality Setpoint shift on pressing the key</p>	<p>reduce setpoint value (step size) increase setpoint value (step size)</p>	<p>This parameter defines the direction of the setpoint shift. For a setpoint value shift, the controller extension makes use of the two communication objects "Output setpoint shift" and "Input setpoint shift". The "Input setpoint shift" communication object informs the extension about the current state of the room temperature controller. Based on this value and the respective parameter, the controller extension determines the new step size which it transmits via the "Output setpoint shift" communication object to the room temperature controller.</p>
<p>"Fan control" functionality Function of key 1</p>	<p>no function automatic mode manual control</p>	<p>When the function of the key is set to "Fan control", it can - when pressed - either activate the automatic control dependent on the room temperature control or the manual control. In this case, each press switches on the next level. After the max. level, the fan control switches the fan off. Thereafter, the levels can be reactivated one after another.</p>
<p>"Info key" functionality Function of the key</p>	<p>no function info mode off info mode on in single-press operation info mode toggle in single-press operation info mode on in double-press operation info mode toggle in double-press operation</p>	<p>On pressing the key, the room controller can switch the info mode on or off or toggle between both states in a defined operation. In addition the user can specify whether the info mode is to be used in single- or in double-press operation</p>

"Page change" functionality	no function scroll to next page scroll to previous page call up page 1 call up page 2 call up page 3 call up page 4 toggle between page 1 and 2 toggle between page 1 and 3 toggle between page 1 and 4	On pressing the key, the screen can display optionally a defined page or change pages in a defined sequence. A change to a non-defined page is prevented by the internal device software.
"Operating mode switch-over" functionality	no function comfort mode standby mode night mode frost /heat protection presence key	On pressing the key, the room temperature controller can be switched to any of the operating modes. The objects for presence detector / key, window status and forced-control object have priority over the operating mode switch-over.
"Setpoint shift" functionality	no function reduce setpoint value increase setpoint value	On pressing the key, the room temperature controller can reduce or increase its setpoint values in steps. The actual setpoint value is calculated by the controller from the basic setpoint value, the current setpoint shift and the step value.

 Keys 2 ... max. 4 see key 1!

Disabling

Disabling function?	yes no	With this parameter, the disabling function of the pushbutton sensor can be centrally activated. If "yes", the ETS shows further communication object and parameters.
Disabling function active... Polarity of disabling object	disable = 1 / enable = 0 disable = 0 / enable = 1	This parameter defines the value of the disabling object at which the disabling function is active.
Reaction of pushbutton sensor at the beginning of the disabling function	no reaction reaction like key >>X<< when pressed reaction like key >>X<< when released reaction like disabling function 1 when pressed reaction like disabling function 1 when released reaction like disabling function 2 when pressed reaction like disabling function 2 when released internal scene recall scene 1 internal scene recall scene 2 internal scene recall scene 3 internal scene recall scene 4 internal scene recall scene 5 internal scene recall scene 6 internal scene recall scene 7 internal scene recall scene 8	Besides disabling of rocker or key functions, the room controller can also and in addition trigger a specific function at the time of activation of the disabling state. This function can... <ul style="list-style-type: none"> • correspond to the function assigned to any of the keys in the non-disabled state ("Reaction like key >>X<< ..."), • be defined on the following parameter pages ("Reaction like disabling function ..."), • recall a scene stored internally in the room controller ("Internal scene recall ...").
Key >>X<<	Key 1 Key 2 ... key 4 *	If the room controller is to perform the function of a specific key at the beginning of the disabling state, this key will be selected here. Visible only if "Reaction of the room controller at the beginning of the disabling state = Reaction like key >>X<< on pressing / releasing of the key"! <p>*: The number of keys depends on the projected room controller variant!</p>
Behaviour during active disabling	all keys without function. all keys behave like... individual keys without function. individual keys behave like...	While disabling is active... <ul style="list-style-type: none"> • all keys or only individually selected keys can be disabled ("... no function"), • all keys or only individually selected keys can be restricted to a specific function ("... behave like..."), In this case, the ETS shows further parameters.

<p>All keys with even numbers behave during disabling like...</p>	<p>key 1 key 2 ... key 4 * disabling function 1 disabling function 2</p>	<p>If a specific key function is to be assigned during disabling to all or to individual keys, this parameter can be used to select the desired key the function of which will then be executed. During disabling, all keys with even numbers (2, 4) behave like the one parameterized here. The desired functions can either correspond to the function of an existing key or they can be parameterized as special disabling functions.</p> <p>Visible only if "Behaviour during active disabling = all keys behave like" or "Behaviour during active disabling = individual keys behave like"!</p> <p>*: The number of keys depends on the projected room controller variant!</p>
<p>All keys with odd numbers behave during disabling like...</p>	<p>key 1 key 2 ... key 4 * disabling function 1 disabling function 2</p>	<p>If a specific key function is to be assigned during disabling to all or to individual keys, this parameter can be used to select the desired key the function of which will then be executed. During disabling, all keys with odd numbers (1, 3) behave like the one parameterized here. The desired functions can either correspond to the function of an existing key or they can be parameterized as special disabling functions.</p> <p>Visible only if "Behaviour during active disabling = all keys behave like" or "Behaviour during active disabling = individual keys behave like"!</p> <p>*: The number of keys depends on the projected room controller variant!</p>

<p>Reaction of pushbutton sensor at the end of disabling</p>	<p>no reaction reaction like key >>Y<< when pressed reaction like key >>Y<< when released reaction like disabling function 1 when pressed reaction like disabling function 1 when released reaction like disabling function 2 when pressed reaction like disabling function 2 when released internal scene recall scene 1 internal scene recall scene 2 internal scene recall scene 3 internal scene recall scene 4 internal scene recall scene 5 internal scene recall scene 6 internal scene recall scene 7 internal scene recall scene 8</p>	<p>Besides disabling of rocker or key functions, the pushbutton sensor can also trigger a special function immediately at the end of disabling.</p> <p>This function can...</p> <ul style="list-style-type: none"> • correspond to the function assigned to any of the keys in the non-disabled state ("Reaction like key >>Y<< ..."), • be defined on the following parameter pages ("Reaction like disabling function ..."), • recall a scene stored internally in the room controller ("Internal scene recall ...").
<p>Key >>Y<<</p>	<p>key 1 key 2 ... key 4 *</p>	<p>If the room controller is to perform the function of a specific key at the end of the disabling state, this key will be selected here.</p> <p>Visible only if "Reaction of the room controller at the beginning of the disabling state = Reaction like key >>X<< on pressing / releasing of the key"!</p> <p>*: The number of keys depends on the projected room controller variant!</p>

Key selection disable



Visible only if "Behaviour during active disabling = individual keys no function" or "Behaviour during active disabling = individual keys behave like"!

Selection of the keys for
behaviour during disabling

Key 1? yes
 no

Key 2? yes
 no

...
Key 4?* yes
 no

The user can specify for each key separately whether it will be affected by the disabling function during the disabling state.

*: The number of keys depends on the projected room controller variant!

Disabling function 1 disable / Disabling function 2 disable



With the exception of the status LED control, the parameters available for the two disabling functions are the same as those for the key functions.

Alarm signalling

Alarm signal display	activated deactivated	This parameter can be used to enable alarm signal displaying When alarm signalling is enabled, the ETS displays further parameters and up to two further communication objects.
Polarity of the alarm signalling object	alarm when ON and alarm reset when OFF alarm when OFF and alarm reset when ON	The alarm signalling object is used as an input for activating or deactivating the signalling of the alarm. When the object value corresponds to the "Alarm" condition, all status LEDs and the operation LED are blinking with a frequency of ca. 2 Hz. If the setting is "Alarm when OFF and alarm reset when ON", the object must first be actively written by the bus with "0" to activate the alarm. An active alarm message is not stored so that the alarm message indication is generally deactivated after a reset or after programming with the ETS.
Reset alarm signalling by a key-press?	yes no	If this parameter is set to "yes", active alarm signal displaying can be deactivated by a key-press on the room controller. This key-press does not cause the parameterized function of the pressed key to be executed. Only after then next key-press will the parameterization of the key be evaluated and a telegram be transmitted to the bus, if applicable. If "no" has been selected, alarm signalling can only be deactivated via the alarm signalling object. A key-press will always execute the parameterized key function.
Use the alarm acknowledge object?	yes no	If a display alarm can be deactivated by a key-press, this parameter defines whether an additional alarm acknowledge telegram is to be transmitted to the bus via the separate object "Alarm signalling acknowledge" after triggering by this key-press. A telegram can, for instance, be sent via this object to the "Alarm signalling" objects of other room controllers in order to reset the alarm status there as well (observe the polarity of the acknowledge object!).
Acknowledge alarm signalling by	OFF telegram * ON telegram *	This parameter sets the polarity of the "Alarm signalling acknowledge" object. *: This parameter presetting depends on the selected polarity of the alarm signalling object.

15.3 Room temperature control

Room temperature control

Room temperature controller function off
on Depending on this parameter, further parameter and objects are displayed.

Controller extension: Controller extension function

Value request from controller extension? yes
no

Controller general

Controller control option **heating** Setting of the control option

cooling
heating and cooling
basic and additional heating
basic and additional cooling
basic and additional heating and cooling

Fan control available **no**
yes

With fan control

Fan control (not effective with switching 2-stage control) heating
cooling
... The possible control options and the standard setting depend on the controller operating mode.
additional heating and cooling

With two-stage operation

Disable object additional stage **no**
yes The additional stages can be disabled via the bus. If "yes" is selected, the disabling object is enabled.

Only with control options "heating and cooling" or "basic and additional heating and cooling"

Transmit actuating variables for heating and cooling to shared object **no**
yes If the parameter is set to "yes", the actuating variable will be transmitted to a shared object during heating or cooling. This function is used, if the same heating system is used to cool the room in the summer and used to heat the room in the winter.

Type of heating control (if applicable, for basic and additional stage) **continuous PI control**
switching PI control PWM)
switching 2-state control (ON/OFF) Selects a control algorithm (PI or 2-point) with data format (1-byte or 1-bit) for the heating system.

With continuous or switching PI control

Type of heating (if applicable, for basic and additional stage) **hot-water heating (5 K / 150 min)**
underfloor heating (5 K / 240 min)
electric heating (4 K / 100 min)
fan convector (4 K / 90 min)
split unit (4 K / 90 min)
via control parameter Adapts the PI algorithm to different heating systems using experience values for the proportional range and reset time control parameters.

Separate input of control parameter

Proportional range heating (10 ... 127) * 0.1 K 10...127, **50** Separate setting of the "proportional range" control parameter.

Reset time heating (0 ... 255) * 1 min; 0 = inactive 0...255, **150** Separate setting of the "reset time" control parameter.

With switching 2-state control		
Lower hysteresis limit of the 2-state controller heating (-128 ... -5) * 0.1 K	-128...-5, -5	Definition of switch-on and switch-off temperatures for heating.
Upper hysteresis limit of the 2-state controller heating (5 ... 127) * 0.1 K	5...127, 5	Definition of switch-on and switch-off temperatures for heating.
Type of cooling control (if applicable, for basic and additional stage)	continuous PI control switching PI control PWM) switching 2-point control (ON/OFF)	Selects a control algorithm (PI or 2-state) with data format (1 byte or 1 bit) for the cooling system. Only if "Transmit actuating variables for heating and cooling to shared object" = "no". If "Transmit actuating variables for heating and cooling to shared object" = "yes", the parameter settings for "Type of heating control" will be accepted.
With continuous or switching PI control		
Type of cooling (if applicable, for basic and additional stage)	cooling ceiling (5 K / 240 min) fan convector (4 K / 90 min) split unit (4 K / 90 min) via control parameter	Adapts the PI algorithm to different cooling systems using experience values for the proportional range and reset time control parameters.
Separate input of control parameter		
Proportional range cooling (10 ... 127) * 0.1 K	10...127, 50	Separate setting of the "proportional range" control parameter.
Reset time cooling (0 ... 255) * 1 min; 0 = inactive	0...255, 240	Separate setting of the "reset time" control parameter.
With switching 2-state control		
Lower hysteresis limit of the 2-state controller cooling (-128 ... -5) * 0.1 K	-128...-5, -5	Defines the switch-on and switch-off temperatures for cooling
Upper hysteresis limit of the 2-state controller cooling (5 ... 127) * 0.1 K	5...127, 5	Defines the switch-on and switch-off temperatures for cooling
Operating mode switch-over	via value (1-byte) via switching (4 x 1-bit)	The switch-over of the operating modes via the bus takes place according to the KONNEX specification via a 1-byte value object. In addition, a higher-ranking forced-control object is available for this setting. The 'classic' switch-over of the operating modes via the bus is via separate 1-bit objects.
Operating mode after reset	comfort mode standby mode night mode frost /heat protection	Defines the operating mode which is set, for instance after a reset caused by bus voltage return or by new programming.

With operating mode switch-over via 1-bit objects Operating mode when all bit objects = 0 (preferred state)	comfort mode standby mode night mode frost /heat protection last state before change to 0	Defines the operating mode which is activated when all 1-bit operating mode objects have value "0".
Mixed control option heating and cooling Switching-over between heating and cooling	automatic via object (heating/cooling switch-over)	Depending on the operating mode and the room temperature, switch-over is automatic. Switch-over only via the "Heating / cooling switch-over" object 35.
Automatic transmission heating/cooling switch-over	when control option changes when output variable changes	Determines when a control option switch-over telegram will be transmitted automatically to the bus via the "Heating / cooling switch-over" object 35.
Cyclical transmission heating/cooling switch-over (0...255) * 1 min; 0=inactive	0 ... 255, 0	Only if "Switch-over between heating and cooling" = "automatic"! The "Heating/cooling switch-over" object can be transmitted cyclically.
 Fan control Fan control not possible with switching 2-state controllers		Info-text without settings
Number of fan intensity levels	no fan levels 1 fan level 2 fan levels 3 fan levels ... 8 fan levels	
Fan level switch-over via	switching objects (8x1 bit) value object (1 byte)	
Threshold fan off -> level 1, *1%	0 ... 100, 1	These parameters determine the actuating variables of the room controller which will cause the fan control to activate the next level.
Threshold fan level 1-> level 2, *1%	0 ... 100, 30	
Threshold fan level 2-> level 3, *1%	0 ... 100, 60	The number of parameters depends on the maximum number of fan intensity levels.
Threshold fan level 3-> level 4, *1%	0 ... 100, 90	
Threshold fan level 4-> level 5, *1%	0 ... 100, 100	
Threshold fan level 5-> level 6, *1%	0 ... 100, 100	
Threshold fan level 6-> level 7, *1%	0 ... 100, 100	
Threshold fan level 7-> level 8, *1%	0 ... 100, 100	
Hysteresis between thresholds, *1%	1 ... 50, 3	When the actuating variable of the room temperature controller has fallen below the threshold minus hysteresis, the fan control switches back to the previous level.

Waiting time for level switching, *0.1s	1 ... 255, 2	If the actuating variable of the room temperature controller changes so fast that the fan control would be forced to switch directly into several successive levels at a time, the switching is performed only after this waiting time.
Level limitation (max. fan level)	no level limitation fan level 1 fan level 2 ... fan level 8	If the fan is to run at certain times (e.g. at night) only with reduced speed, the level limitation can be activated.
Behaviour with forced-control	no forced-control fan level 1 fan level 2 ... fan level 8 OFF	The forced-control function permits control from a higher-ranking system.
Interpretation of object fan control automatic/manual	0=automatic, 1=manual 1=automatic, 0=manual	The parameter defines the polarity of the object for switching over between automatic and manual control.
Fan level when switching to manual	no change fan level 1 fan level 2 ... fan level 8 fan level OFF	This level is selected, when the fan control switches over from automatic to manual operation.
Fan shut-off delay heating, *0.1s, 0=inactive	0 ... 255, 0	Fan shut-off is delayed in automatic and in manual operation by this time.
Fan shut-off delay cooling, *0.1s, 0=inactive	0 ... 255, 0	Fan shut-off is delayed in automatic and in manual operation by this time.
Fan protection	no yes	With the 1-bit fan protection object, the fan can be switched to the highest possible level (taking into account level limitation and forced-control setting).
Start-up via level	fan level OFF fan level 1 fan level 2 ... fan level 8	If the fan does not start up safely when at a low level, a higher level can be selected in this parameter. For starting, the fan switches in this case first to the level selected and then gradually down.
Actuating variable is 0% until internal actuating variable is greater than..., *1%	1	If necessary, these three parameters can be used for adapting the internal characteristics for determination of the automatic fan level.
Actuating variable is 100% when internal actuating variable is greater than..., *1%	99	If the computational offset exceeds 100%, it will be limited by the internal device software.
Actuating variable offset, *1%	0	

Actuating variable and status output

Automatic transmission if value changes by... (0...100) * 1 %; 0 = inactive	0 to 100, 3	Determines the size of the actuating variable change that will cause the automatic transmission of the continuous actuating variables via the actuating variable objects.
Cycle time of switching variable (1...255) * 1 min	1 to 255, 15	Only if at least one type of control is parameterized to "continuous PI control"! Determines the cycle time for the pulse width modulated actuating variable (PWM). Only if at least one type of control is parameterized to "switching PI control (PWM)".
Cycle time for automatic transmission (0...255) * 1 min; 0 = inactive	0 to 255, 10	Time interval for the cyclical transmission of the actuating variable via the actuating variable objects. Only if at least one type of control is parameterized to "continuous PI control" or "switching 2-state control".
Output of actuating variable heating	inverted (closed when sourcing current) normal (opened when sourcing current)	continuous: act. var. = 100 % - normal act. var. switching: act. var. = 1 - normal act. var. normal actuating variable output heating
Output of actuating variable basic stage heating	inverted (closed when sourcing current) normal (opened when sourcing current)	only with "control option = Heating" or "Heating and cooling"! continuous: act. var. = 100 % - normal act. var. switching: act. var. = 1 - normal act. var. normal actuating variable output heating
Output of actuating variable additional heating	inverted (closed when sourcing current) normal (opened when sourcing current)	only with "control option = Heating" or "Heating and cooling"! continuous: act. var. = 100 % - normal act. var. switching: act. var. = 1 - normal act. var. normal actuating variable output heating
Output of actuating variable cooling	inverted (closed when sourcing current) normal (opened when sourcing current)	only with "control option = Heating" or "Heating and cooling"! continuous: act. var. = 100 % - normal act. var. switching: act. var. = 1 - normal act. var. normal actuating variable output heating
Output of actuating variable basic stage cooling	inverted (closed when sourcing current) normal (opened when sourcing current)	only with "control option = Heating" or "Heating and cooling"! continuous: act. var. = 100 % - normal act. var. switching: act. var. = 1 - normal act. var. normal actuating variable output heating
		only with "control option = Heating" or "Heating and cooling"!

Output of actuating variable additional stage cooling	<p>inverted (closed when sourcing current)</p> <p>normal (opened when sourcing current)</p>	<p>continuous: act. var. = 100 % - normal act. var. switching: act. var. = 1 - normal act. var.</p> <p>normal actuating variable output heating</p> <p>only with "control option = Heating" or "Heating and cooling"!</p>
Heating message	<p>no</p> <p>yes</p>	<p>Enables the "heating" message function and thus the "Heating message" object.</p>
Cooling message	<p>no</p> <p>yes</p>	<p>Enables the "cooling" message function and thus the "Cooling message" object.</p>
Controller status	<p>no status</p> <p>controller general</p>	<p>The controller can output its current operating status.</p> <p>No status will be output.</p> <p>The controller status is generally output via the 1-byte object (object 36 "Controller status").</p>
Individual status	<p>transmitting individual status</p> <p>comfort mode active</p> <p>standby mode active</p> <p>night mode active</p> <p>frost/heat protection active</p> <p>controller disabled</p> <p>heating/cooling</p> <p>controller inactive</p> <p>frost alarm</p>	<p>The controller status preset by the "Individual status" parameter will be output via the 1-bit object (Object 36 "Controller status").</p> <p>Defines the controller status to be transmitted.</p> <p>Only if "Controller status" = "transmit individual status".</p>

Setpoint values

Basic temperature after reset (7 ... 4.) * 1 °C	7.0 °C to 40 °C, 21 °C	Defines the basic setpoint value after the initialization.
Adopt change of basic setpoint shift permanently	no yes	
Basic temperature setpoint change	deactivated permit via the bus	Determines whether an adjustment of the basic temperature is possible via the bus.
Adopt basic temperature setpoint permanently	no yes	This parameter determines whether the basic temperature value which has been adjusted via the bus is to be stored permanently (setting "yes") or only temporarily (setting "no").
		When set to "yes" the changed basic value will be retained even after a switch-over of the operating mode and after a reset.
		Only if "Basic temperature setpoint change" = "permit via the bus"
Frost protection setpoint temperature (7...40) * 1 °C	7 °C to 40 °C, 7 °C	Defines the setpoint temperature with activated frost protection.
		Only if "Control option" = "heating" or "heating and cooling", if applicable, with additional stage
Heat protection setpoint temperature (7...45) * 1 °C	7 °C to 45 °C, 35 °C	Defines the setpoint temperature with activated heat protection.
		Only if "Control option" = "cooling" or "heating and cooling", if applicable, with additional stage.
Dead zone position:	Symmetrical Asymmetrical	The comfort setpoint temperatures for heating and cooling are derived from the basic setpoint in consideration of the adjusted dead zone. The dead zone (temperature zone for which there is neither heating nor cooling) is the difference between the comfort setpoint temperatures.
		Symmetrical: The dead zone can be equally positioned above and below the basic setpoint (e. g. +/- 1K). The comfort setpoint temperatures are derived directly from the basic setpoint resulting from the half dead zone.
		Asymmetrical: With this setting, the comfort setpoint temperature for heating equals the basic setpoint! The preset dead zone takes only effect from the basic setpoint in the direction of comfort temperature for cooling. Thus the comfort setpoint temperature for cooling is derived directly from the comfort setpoint for heating.
		Only with the "heating and cooling" or "basic / additional heating/cooling" mixed modes.

<p>Dead zone between heating and cooling (0...127) * 0.1 K</p>	<p>0 to 127, 20</p>	<p>The comfort setpoint temperatures for heating and cooling are derived from the basic setpoint in consideration of the adjusted dead zone. The dead zone (temperature zone for which there is neither heating nor cooling) is the difference between the comfort setpoint temperatures.</p>
<p>Stage offset from the basic to the additional stage (0...127) * 0.1 K</p>	<p>0 to 127, 20</p>	<p>Only with the "heating and cooling" or "basic / additional heating/cooling" mixed modes. In a two-stage control mode it is necessary to determine the temperature difference to the basic stage with which the additional stage is to be incorporated into the control.</p>
<p>Transmit when setpoint temperature changes by (0...255) * 0.1 K</p>	<p>0 to 255, 1</p>	<p>Only in two-stage controller operation Determines the size of the value change required for automatic transmission of the current value via the "Setpoint temperature" object.</p>
<p>Cyclical transmission of setpoint temperature (0...255) * 1 min; 0 = inactive</p>	<p>0 to 255, 0</p>	<p>0 = no automatic transmission Determines whether the setpoint temperature is to be cyclically output via the "Setpoint temperature" object.</p>
<p>Adjustment of setpoint to higher temperatures</p>	<p>0 K +1 K +2 K +3 K +4 K +5 K</p>	<p>Determines the maximum adjustment range for the upward adjustment of the basic setpoint temperature.</p>
<p>Step width for gradual setpoint shift upwards</p>	<p>+0.5 K +1.0 K +1.5 K +2,0K</p>	<p>For gradual shifting of the setpoints from a controller extension or on the second operator control level, the controller uses this parameter to calculate its new setpoint.</p>
<p>Adjustment of setpoint to lower temperatures (-10...0) * 1 K</p>	<p>0 K -1 K -2 K -3 K -4 K -5 K</p>	<p>Determines the maximum adjustment range for the downward adjustment of the basic setpoint temperature.</p>
<p>Step width for gradual setpoint shift downwards</p>	<p>-1.0 K -1.5 K -2.0K</p>	<p>For gradual shifting of the setpoints from a controller extension or on the second operator control level, the controller uses this parameter to calculate its new setpoint.</p>
<p>Decreasing the setpoint temperature in standby mode (heating) (-128...0) * 0.1 K</p>	<p>-128 to 0, -20</p>	<p>The value by which the standby setpoint temperature for heating is lowered compared to the basic setpoint.</p>
<p>Decreasing the setpoint temperature in night mode (heating) (-128...0) * 0.1 K</p>	<p>-128 ... 0, -40</p>	<p>Only if "Control option = "heating" or "heating and cooling", if applicable, with additional stages.</p>
		<p>The value by which the night setpoint temperature for heating is lowered compared to the basic setpoint.</p>
		<p>Only if "Control option = "heating" or "heating and cooling", if applicable, with additional stages.</p>

Decreasing the setpoint temperature in standby mode (cooling) (0...127) * 0.1 K	0 to 127, 20	The value by which the standby setpoint temperature for cooling is lowered compared to the basic setpoint. Only if "Control option = "cooling" or "heating and cooling", if applicable, with additional stages.
Increasing the setpoint temperature in standby mode (cooling) (0...127) * 0.1 K	0 to 127, 40	The value by which the night setpoint temperature for cooling is lowered compared to the basic setpoint. Only if "Control option = "cooling" or "heating and cooling", if applicable, with additional stages.
Setpoint temperature limitation in cooling operation	no limitation only difference to outside temperature only max. setpoint temperature max. setpoint temperature and difference to outside temperature	In the case of strongly increasing outside temperatures, the controller can keep the setpoint temperature during cooling within these limits.
Activation of setpoint temperature limitation in cooling operation via object	no yes	This parameter determines whether the 1-bit object for setpoint temperature limitation is displayed.
Difference to outside temperature in cooling operation	1 K ... 15 K, 6 K	This parameter defines the maximum difference between the setpoint temperature in the comfort mode and the outside temperature
Max. setpoint temperature in cooling operation	20°C ... 35°C, 26°C	The comfort mode setpoint temperature cannot exceed this value neither by manual setpoint shift nor by automatic correction.

Controller functions

Presence detection	presence key	The presence detection takes place via a presence key on the controller or via the presence object (e.g. presence detector). A press on the presence key activates the comfort mode prolongation.
	presence detector	The presence detection takes place via an external presence detector. The detector is coupled via the presence object. If presence is detected, the comfort mode will be activated as long as the presence detector detects movement. The presence key is without function.
With presence key Duration of comfort mode prolongation. (0 ...255) * 1 min; 0 = OFF	0 to 255, 30	An actuation of the presence key causes the controller to switch into the comfort mode for this time. After this time, the controller switches back automatically
Switching off the controller (dew-point operation)	no via the bus	This parameter enables the "Disable controller" object 40. There is no control until enabled (actuating variables = 0). Disabling of the controller when active (dew-point operation) is displayed on the screen.
Valve protection	no yes	The valve is periodically opened (every 24 hours). Works against calcification and thus prevents the valve from getting stuck.
Temperature limitation (underfloor heating) Acting on...	not available available basic stage heating additional stage heating	Activates or deactivates the temperature limitation. Determines the controller output to which the underfloor heating is connected
Maximum temperature underfloor heating * 1°C	20,0°C ... 70,0°C, 30°C	The max. admissible temperature can be set depending on the construction of the underfloor heating. If this temperature is exceeded, the underfloor heating is shut off until the temperature has dropped by at least 1 K.
Limit temperature hysteresis	1 K	Fixed value

Room temperature measurement

Temperature detection		Determines which sensor will be used for room temperature measurement.
	internal sensor	Internal sensor: built-in sensor of the controller
	external sensor	External sensor": An external sensor coupled via the bus, e.g. for complicated measuring conditions (swimming pools or similar).
	internal and external sensor	Internal and external sensor: Both sensors are used, for example, in large rooms.
Determination of measured value from internal / external ratio	10% to 90 % 20% to 80 % 30% to 70 % 40% to 60 % 50% to 50 % 60% to 40 % 70% to 30 % 80% to 20 % 90% to 10 %	Determines the weighting of the measured temperature value for the internal and external sensors. That results in an overall value which will be used for the further evaluation of the room temperature. Only if "Temperature detection" = "internal and external sensor"
Calibration of internal sensor (-128...127) * 0.1 K	-128 to 127, 0	Determines the value by which the internal sensor's room temperature value is calibrated. Only if "Temperature detection = internal sensor" or "internal and external sensor".
Calibration of external sensor (-128...127) * 0.1 K	-128 to 127, 0	Determines the value to which the external sensor's room temperature value is adapted. Only if "Temperature detection = external sensor" or "internal and external sensor".
Interrogation interval for external sensor (0...255) * 1 min; 0 = inactive	0 to 255, 0	Determines the interrogation interval for the external sensor's temperature value . 0" = sensor transmits its temperature value automatically. Only if "Temperature detection = external sensor" or "internal and external sensor".
Transmit when setpoint temperature changes by (0..255) * 0,1 K; 0 = no automatic transmission	0 to 255, 3	Determines the size of the value change of the room temperature after which the current values are automatically transmitted to the bus via the "Actual temperature" object.
Cyclical transmission of room temperature (0...255) * 1 min; 0 = inactive	0 to 255, 15	Determines whether or when the determined room temperature is to be cyclically output via the "Actual temperature" object.

📁 Second operator control level



Change of comfort mode setpoint temperature	disabled enabled	Determines whether the temperature can be changed on the second operator control level.
Change of standby mode setpoint temperature (heating)	disabled enabled	Determines whether the temperature can be changed on the second operator control level.
Change of standby mode setpoint temperature (cooling)	disabled enabled	Determines whether the temperature can be changed on the second operator control level.
Change of night mode setpoint temperature (heating)	disabled enabled	Determines whether the temperature can be changed on the second operator control level.
Change of night mode setpoint temperature (cooling)	disabled enabled	Determines whether the temperature can be changed on the second operator control level.
Display & change of max. setpoint temperature (cooling)	disabled enabled	Determines whether the temperature can be changed on the second operator control level.
Display & change difference to outside temperature	disabled enabled	Determines whether the temperature can be changed on the second operator control level.

15.4 Display

Display



Backlighting	<p>always OFF always ON on by key-press on in night mode on by key-press or in night mode Switching object inverted switching object on by key-press or via switching object on by key-press or via inverted switching object value object (0% ... 100%) on by key-press or via value object</p>	<p>The display backlighting can be permanently on or off or it can be switched or dimmed driven by specific events.</p> <p>In the case of an activation by key-press, the room controller switches the lighting off again after a presettable time.</p> <p>In the case of an activation by another event (object value), the room controller switches the lighting off when the event has ended.</p>
Automatic switch-off after	<p>15 s 30 s 45 s 1.0 min 1.5 min ... 1 h</p>	<p>The display backlighting is switched off automatically after the preset time, if it had been switched on by a key-press.</p>
Number of display pages	<p>1 page 2 pages 3 pages 4 pages</p>	<p>Depending on the number of pages defined, further parameters and communication objects are displayed.</p>
Display page recall	<p>no recall via switching object via value object (1 byte)</p>	<p>This parameter can be used to display a 1-bit object for recalling of a defined page or a 1-byte object for recalling of any page. If the 1-bit object gets a value of "1" or when the 1-byte object gets a value from "1" to "4", the corresponding page is displayed. In this case, the cyclical display of pages is stopped. The normal cyclical display is resumed only after the object gets a value of "0".</p>
Recall via switching object Display page switching object	<p>page 1 page 2 page 3 page 4</p>	<p>If the 1-bit object is used for page recall, this parameter determines which page is brought into the foreground.</p>

Cyclical page change (1 ... 60s)	1 ... 60, 15	This parameter defines how fast the display switches over between pages. In addition, the user can specify for each individual page whether it is to be included in the cyclical page change.
Info display after initialization	OFF Single-press operation Double-press operation	This parameter determines whether the display info mode is to be active after a new start (e.g. commissioning, return of voltage). In addition, the info mode can be selected. When this parameter is set to "off", the "Info-mode" object is not shown in the ETS.
Info text display time	3 s 5 s 10 s	This parameter determines how long the help texts of the info mode are to be displayed when a key is pressed.
Display pictogram frame	no yes	Without the pictogram frame, only the presently active pictograms are visible. When the pictograms are displayed, the frames of the inactive pictograms are visible as placeholders.
<p>Page 1 to page 4:</p> <p> Except for the cyclical page change parameter, the setting options for the display pages are the same.</p>		
Page 1 in cyclical change	yes	The parameter defines whether the page is to be part of the cyclical change. For page 1, this parameter is set invariably to "yes". For the other pages, it can be changed.
Number of the symbol to be displayed from table of symbols page 1	0 ... 30, 0	The device software includes 30 symbols which can be displayed at the right margin of the text area. This parameter selects the symbol to be displayed. A value of "0" means that no symbol is displayed.
Recall of the symbol on page 1	parameterized symbol via 1-bit object via 1-byte object	The parameter determines whether the above selected symbol is fixed or whether it can be changed in operation.
<p>Only with recall via 1-bit object</p>		
Number of the symbol to be displayed for object value = 0 on page 1	0 ... 30, 0	When the symbol is selected via a 1-bit object, it is possible to choose different symbols for the two object values "0" and "1". A value of "0" means that no symbol is displayed.
Number of the symbol to be displayed for object value = 1 on page 1	0 ... 30, 0	
Number of lines	1 line 2 lines with large unit 2 lines with small unit 3 lines	The parameter fixes the number of text lines on the display page. Depending on this setting, further parameters and communication objects are displayed.

One-line display		
 Line 1		
Line display	time of day time-of-day and weekday date setpoint temperature actual temperature: external temperature date + time of day time of day and date time of day + actual temperature Time of day + setpoint temperature Time of day + external/outside temperature	The parameter permits selecting the information to be displayed. The format of the corresponding values is fixed.
Two-line display		
 Line 1		
Line display	time of day: time-of-day and weekday date setpoint temperature actual temperature: external temperature date + time of day time of day and date time of day + actual temperature time of day + setpoint temperature time of day + external/outside temperature value display fixed DPT 5.xxx (EIS 6) value display fixed DPT 9.xxx (EIS 5) value display fixed DPT 14.xxx (EIS 9)	The parameter permits selecting the information to be displayed. The format of the corresponding values is fixed.
Value display fixed DPT 5.xxx		
Unit text	(no standard value)	The unit text follows the value or the percentage sign directly without a space.
Display format	0 ... 255 0 ... 100%	1-byte values are optionally displayed as integers or as percentages.
Value display DPT 9.xxx and DPT 14.xxx		
Unit text	(no standard value)	The unit text follows the value or the percentage sign directly without a space.
Offset	-100000,00000 ... 100000,00000; 0	These parameters permit adapting the values.
Amplification	0,000 ... 100000,000; 1	
Number of digits to the left of the decimal point	0 ... 9, 3	
Number of digits after the decimal point	0 ... 3, 0	
Sign	no yes	

Line 2

<p> Line 2</p> <p>Line display</p>	<p>time of day: time-of-day and weekday date setpoint temperature actual temperature: time of day and date switching dimming blind/shutter light-scene value display fixed DPT 5.xxx (EIS 6) value display fixed DPT 6.xxx (EIS 14) value DPT 7.xxx (EIS 10 unsigned) value DPT 8.xxx (EIS 10 unsigned) value DPT 9.xxx (EIS 5) value DPT 12.xxx (EIS 11 unsigned) value DPT 13.xxx (EIS 11 signed) value DPT 14.xxx (EIS 9) value DPT 16.xxx (EIS 15) Static text (no standard value)</p>	<p>The parameter permits selecting the information to be displayed.</p>
<p>Line text</p>	<p>(no standard value)</p>	<p>This text is displayed left-aligned It may have a maximum number of 18 characters.</p>
<p>Only with switching: Text for switching object value 0</p>	<p>off</p>	<p>The two texts for the different object values can be changed. They may have a maximum number of 18 characters.</p>
<p>Text for switching object value 1</p>	<p>on</p>	<p>The two texts for the different object values can be changed. They may have a maximum number of 18 characters.</p>
<p>Only with blind/shutter: Text for move object value 0</p>	<p>off</p>	<p>The two texts for the different object values can be changed. They may have a maximum number of 18 characters.</p>
<p>Text for move object value 1</p>	<p>on</p>	<p>The two texts for the different object values can be changed. They may have a maximum number of 18 characters.</p>
<p>Value display fixed DPT 5.xxx Unit text</p>	<p>(no standard value)</p>	<p>The unit text follows the value or the percentage sign directly without a space.</p>
<p>Display format:</p>	<p>0 ... 255 0 ... 100%</p>	<p>1-byte values are optionally displayed as integers or as percentages.</p>

Value display DPT 5.xxx to DPT 9.xxx and DPT 14.xxx		
Unit text	(no standard value)	The unit text follows the value or the percentage sign directly without a space.
Offset	-100000,00000 ... 100000,00000; 0	These parameters permit adapting the values.
Amplification	0,000 ... 100000,000; 1	
Number of digits to the left of the decimal point	0 ... 9, 3	
Number of digits after the decimal point	0 ... 3, 0	
Sign	no yes	
With value display DPT 12.xxx		
Unit text	(no standard value)	The unit text follows the value or the percentage sign directly without a space.
With value display DPT 13.xxx		
Unit text	(no standard value)	The unit text follows the value or the percentage sign directly without a space.
Sign	no yes	The value can be displayed with or without sign.
Three-line display		
	Line 1	See line 2 of two-line display
	Line 2	See line 2 of two-line display
	Line 3	See line 2 of two-line display

15.5 Scenes

Scenes

Scene function?	yes no	The room controller can handle internally eight scenes with eight actuator groups. This parameter activates the scene function and the other parameters and communication objects, if needed.
Overwrite scene values during ETS download	yes no	If the values of the actuator groups that have been changed on site by the customer are to be reset to the values preset in the ETS during an application download by the ETS, the setting "Yes" must be chosen. If "no" is selected, the ETS values will not overwrite the scene values stored in the room controller, if any.
Data types	switching	The room controller has an independent communication object for each of the eight actuator groups. With these parameters, the object type can be set separately for each output.
scene output 1	value (0 ... 255) value / blind/shutter position (0 ... 100 %)	
...		
scene output 8	switching value (0 ... 255) value / blind/shutter position (0 ... 100 %)	
<h4> Scene 1</h4>		
Recall via extension object with scene number	1 ... 64	If the internal scenes are to be recalled via the extension object, a definite number is required for each of them. This parameter serves to specify the extension number of the first scene. If several internal scenes have the same scene number, only the first scene with this number can be called up.
Scene output 1 switching command	ON OFF	This parameter can be used to predefine the switching command of the first scene output. Visible only if "Data types scene output 1 = switching"!
Scene output 1 value (0 ... 255)	0 ... 255	This parameter can be used to predefine the value of the first scene output. Visible only if "Data types scene output 1 = value (0 ... 255)"!
Scene output 1 value / blind/shutter position (0 ... 100 %)	0 ... 100	This parameter can be used to predefine the value of the first scene output. Visible only if "Data types scene output 1 = value / shutter position (1 ... 100 %)"!

Scene output 1

Scene output 1	yes no	If the user is to be given the possibility of changing the value of the actuator group (scene output) within this scene and of storing it during regular operation, this parameter must be set to "yes".
Permit storing?		
Scene output 1	yes no	If the state of actuator group is to remain unchanged during the recall of a scene, this parameter can be set to "no". In this case, the room controller does not transmit a telegram via the scene output concerned during the recall of the scene. The scene output is deactivated for this scene.
Permit transmission?		
Scene output 1	0 ... 1200	When the room controller sends the telegrams to the various scene outputs, it can insert a presettable waiting time of 2 min. max. before each telegram.
Transmit delay (1 ... 1200 * 100 ms) (0 = deactivated)		This can be used to reduce bus loading, but also to have certain lamps switched on only after the shutters are really closed. If no delay is selected, the room controller sends the output telegrams with maximum speed. With this setting it may happen in some cases that the telegram sequence is not compatible with output numbering.
Scene outputs 2 ... 8 see scene output 1!		
 Scenes 2 ... 8 see scene 1!		

Software information

Physical Sensors

Automatic Switch – Standard

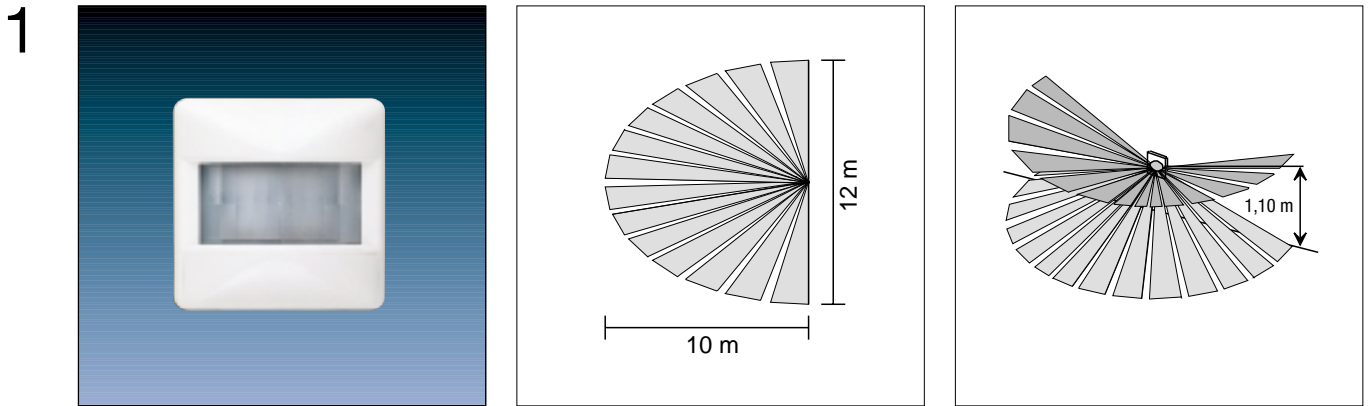

2

	Ref.-No.
KNX PIR automatic switch 180°	
1.1 m, standard	
ETS-product family:	Physical sensors
Product type:	Movement
ranges CD 500/CD plus	
ivory	3180
white	CD 3180 WW
blue	CD 3180 BL
brown	CD 3180 BR
grey	CD 3180 GR
light grey	CD 3180 LG
red	CD 3180 RT
black	CD 3180 SW
ranges LS 990/LS plus/Stainless Steel/Aluminium/Anthracite/Gold/Chrome	
ivory	LS 3180
white	LS 3180 WW
light grey	LS 3180 LG
Metal versions	
stainless steel	ES 3180
aluminium	AL 3180
anthracite	AL 3180 AN
gold coloured	GO 3180
chrome	GCR 3180
ranges AS 500/A 500/A plus	
ivory	A 3180
white	A 3180 WW
aluminium	A 3180 AL

3 The KNX automatic switch is plugged onto a flush mounted bus coupling unit. It reacts to changes in temperature like people moving into the detection area. This causes switching commands to devices such as binary outputs to switch groups of lights. The automatic switch has a detection angle of 180° and an area of 10 x 12 m. This angle can be restricted to 90° with a slip-on screen. The device has to be mounted at a height of 1.1 m.

Software applications:

PIR single unit	A00101	Vers. 1
PIR master	A00201	Vers. 1
PIR extension	A00301	Vers. 1

1

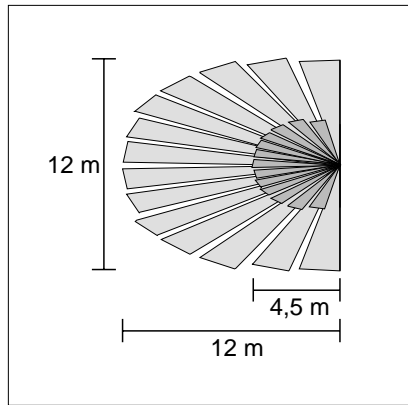

2

	Ref.-No.
KNX PIR automatic switch 180°	
2.2 m, standard	
ETS-product family:	Physical sensors
Product type:	Movement
ranges CD 500/CD plus	
ivory	3280
white	CD 3280 WW
blue	CD 3280 BL
brown	CD 3280 BR
grey	CD 3280 GR
light grey	CD 3280 LG
red	CD 3280 RT
black	CD 3280 SW
ranges LS 990/LS plus/Stainless Steel/Aluminium/Anthracite/Gold/Chrome	
ivory	LS 3280
white	LS 3280 WW
light grey	LS 3280 LG
Metal versions	
stainless steel	ES 3280
aluminium	AL 3280
anthracite	AL 3280 AN
gold coloured	GO 3280
chrome	GCR 3280
ranges AS 500/A 500/A plus	
ivory	A 3280
white	A 3280 WW
aluminium	A 3280 AL

3

The KNX automatic switch is plugged onto a flush mounted bus coupling unit. It reacts to changes in temperature like people moving into the detection area. This causes switching commands to devices such as binary outputs to switch groups of lights. The automatic switch has a detection angle of 180° and an area of 12 x 12 m. This angle can be restricted to 90° with a slip-on screen. The device has to be mounted at a height of 2.2 m.

Software applications:

PIR single unit	A00101	Vers. 1
PIR master	A00201	Vers. 1
PIR extension	A00301	Vers. 1

4 Technical data:

Supply	
Voltage:	24 V DC (+6 V / -4 V) via BCU
Power consumption:	max. 110 mW
Connection:	2 x 5-pole pin bar
Protection:	IP 20
Insulation voltage:	referring to V VDE 0829 part 230

Behaviour at	
Bus voltage drop:	no telegrams are sent
Bus voltage return:	object values = 0, out of function for approx. 80 sec.
Operation temperature:	-5°C ... +45°C
Storage temperature:	-25°C ... +75°C
Mounting:	plugged onto a flush mounted BCU

5 Description of application

1. Single unit A 00101

After detection of any movement the device will send an ON-telegram. At the end of detection and after the default min. delay time of 10 sec an OFF-telegram will be released. The evaluation of detection and the delay time can also be changed by parameters.

To avoid malfunctions after releasing the OFF-telegram (e.g. wrong detection by cooling down of a switched off halogen lamp), the device is locked-out for about 3 sec. In between these 3 sec no detection can be evaluated. The lock-out time can be adjusted by parameters.

The automatic switch only evaluates detections when the brightness value is under the adjusted dimmed lighting level which has a default value of 15 Lux. There is also the possibility to set the device brightness independent.

Additionally, a cyclical transmission during the detection can be activated.

By a special object the so-called disable object, the automatic switch is inactive. That means it can not detect any movement as long as the disable object is active. The telegram at start and end of blocking can be adjusted by parameters.

Objects

Number of addresses (dynamic):	5
Number of assignments (dynamic):	5
Communication objects:	2

Object	Name	Function	Type	Flag
0	Switch	Switch	1 Bit	C, W, T
1	Disable	Disable	1 Bit	C, W

Description of application

2. Master unit A 00201 / extension unit A 00301

With the combination of these applications it is possible to have one or several extension units (satellites) to one master unit.

Additionally, to the features of the application single unit there is one more object, the so-called movement object.

That is the object used for the communication between the master and the extension unit.

Every extension unit receives the real switch telegram of the master unit by the object switch (status). That is necessary for the extension to know the real switch status of the master.

Note: In the project design you have to take care that the switch objects of the devices (master/extensions) and the movement objects are connected together.

After commissioning or after bus voltage recovery the device is blocked for about 80 sec. During that time no movements can be detected.

Objects

Number of addresses (dynamic):	6
Number of assignments (dynamic):	6
Communication objects:	3

Object	Name	Function	Type	Flag
0	Switch	Switch	1 Bit	C, W, T
1	Disable	Disable	1 Bit	C, W
2	Movement	Event signal from extensions input	1 Bit	C, W, T
2	Movement	Event signal to master	1 Bit	C, W, T

Physical Sensors

Automatic Switch – Universal

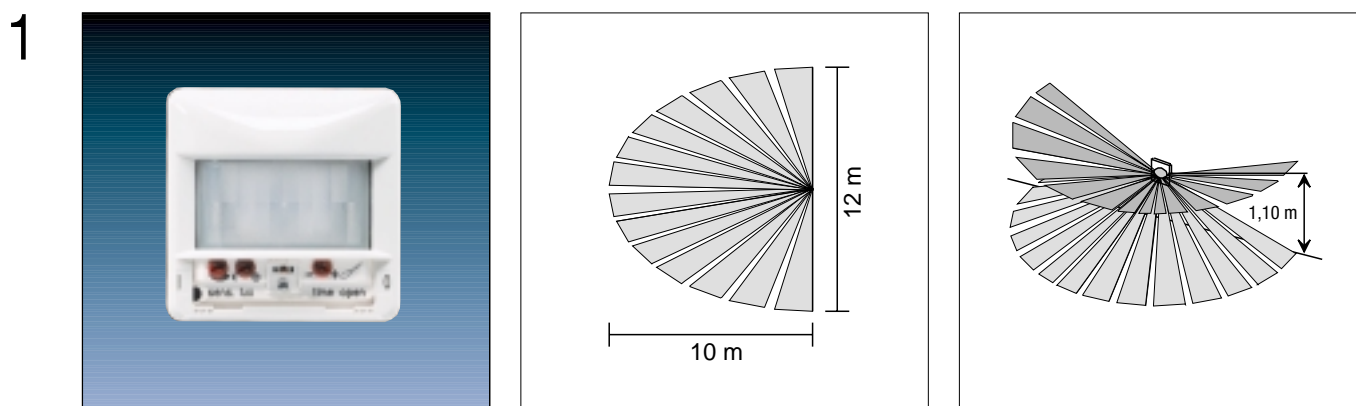

2

	Ref.-No.
KNX PIR automatic switch 180°	
1.1 m, universal	
ETS-product family:	Physical sensors
Product type:	Movement
ranges CD 500/CD plus	
ivory	3180-1 A
white	CD 3180-1 A WW
blue	CD 3180-1 A BL
brown	CD 3180-1 A BR
grey	CD 3180-1 A GR
light grey	CD 3180-1 A LG
red	CD 3180-1 A RT
black	CD 3180-1 A SW
ranges LS 990/LS plus/Stainless Steel/Aluminium/Anthracite/Gold/Chrome	
ivory	LS 3180-1 A
white	LS 3180-1 A WW
light grey	LS 3180-1 A LG
Metal versions	
stainless steel	ES 3180-1 A
aluminium	AL 3180-1 A
anthracite	AL 3180-1 A AN
gold coloured	GO 3180-1 A
chrome	GCR 3180-1 A
ranges AS 500/A 500/A plus	
ivory	A 3180-1 A
white	A 3180-1 A WW
aluminium	A 3180-1 A AL

3 The KNX automatic switch is plugged onto a flush mounted bus coupling unit. It reacts to changes in temperature like people moving into the detection area. This causes switching commands or value transmission to devices such as binary outputs to switch groups of lights or dimming actuators. It can also be used to release a light scene in combination with a light scene push-button. It has three potentiometers for time, brightness and sensitivity adjustable from the front side. A slide switch (ON/AUTO/OFF) is also integrated. The automatic switch has two major modes. There is one for lighting purposes as already explained and one for monitoring purposes used for simple alarm detection or in connection with the Central Alarm Unit EAM 4000. By activating a specific object the device can be toggled between these modes.

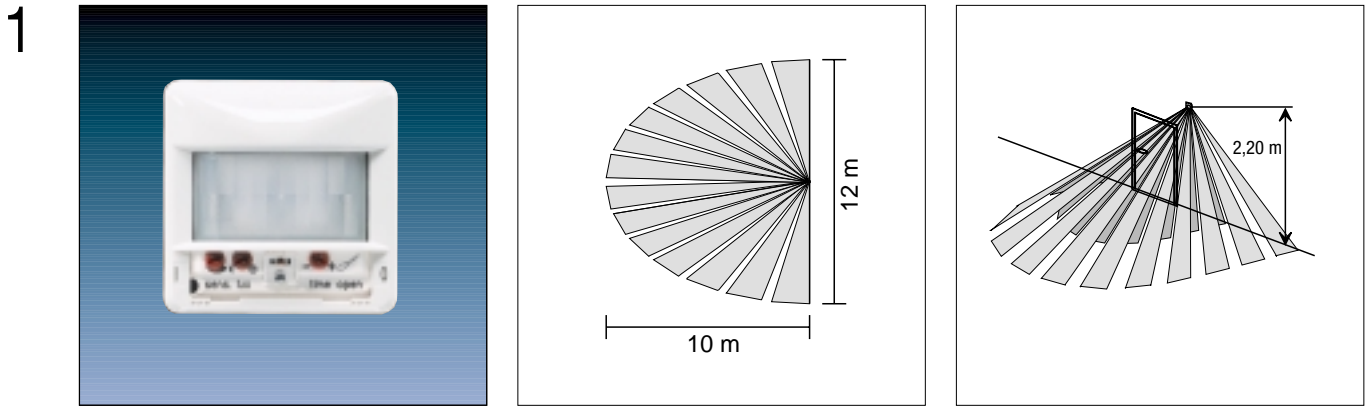

2

	Ref.-No.
KNX PIR automatic switch 180°	
2.2 m, universal	
ETS-product family:	Physical sensors
Product type:	Movement
ranges CD 500/CD plus	
ivory	3280-1 A
white	CD 3280-1 A WW
blue	CD 3280-1 A BL
brown	CD 3280-1 A BR
grey	CD 3280-1 A GR
light grey	CD 3280-1 A LG
red	CD 3280-1 A RT
black	CD 3280-1 A SW
ranges LS 990/LS plus/Stainless Steel/Aluminium/Anthracite/Gold/Chrome	
ivory	LS 3280-1 A
white	LS 3280-1 A WW
light grey	LS 3280-1 A LG
Metal versions	
stainless steel	ES 3280-1 A
aluminium	AL 3280-1 A
anthracite	AL 3280-1 A AN
gold coloured	GO 3280-1 A
chrome	GCR 3280-1 A
ranges AS 500/A 500/A plus	
ivory	A 3280-1 A
white	A 3280-1 A WW
aluminium	A 3280-1 A AL

3 The automatic switch has a detection angle of 180° and an area of 10 x 12 m. This angle can be restricted to 90° with a slip-on screen. The device has to be mounted in a height of 2.2 m. Additionally, the device has an integrated red LED used for testing mode or alarm indication when the cover was removed from the insert. It can also be programmed to release an alarm indication if somebody manipulated the cover.

Software application:
PIR universal A00802

4 Technical data:

Supply			
Voltage:	24 V DC (+8 V / -3 V)		
Power consumption:	typical 150 mW		
Connection:	KNX connection block		
Input:	for mounting height 1,10 m	for mounting height 2,20 m	
Opening angle	180°	180°	
Range, frontal	10 m	10 m	
Range, side	2 x 6 m	2 x 6 m	
No. of lences/detection levels	18/2	18/2	
Protection:	IP 20		
Behaviour at voltage drop:	no response		
	Active movements detected or running delays will be disregarded and not continued after bus voltage recovery.		
Behaviour at voltage recovery:	depending on the used mode		
	thermal movement detection immunity time: approx 80 s		
Operation temperature:	-5°C ... +45°C		
Storage temperature:	-25°C ... +75°C		
Mounting:	plug onto a flush-mounted bus coupler		

5 Objects

Number of addresses (dynamic):	28
Number of assignments (dynamic):	28
Communication objects:	max. 9 (dynamic)

Object	Name	Function	Type	Flag
0	Switching	Switching	1 Bit	W, C, T, (R)*
1	Valuator	Valuator	1 Byte	W, C, T, (R)*
1	Light scene	Light scene	1 Bit	W, C, T, (R)*
	Extension input	Extension input	1 Byte	
2	Disable	Disable	1 Bit	W, C, (R)*
3	Level of dimmed	Detection (not)		
	Lighting	Brightness depend.	1 Bit	W, C, T, (R)*
4	Event signal from	Movement	1 Bit	W, C, T, (R)*
	Extension input			
4	Event signal to master	Movement	1 Bit	W, C, T, (R)*
5	Event signal	Event signal	1 Bit	W, C, T, (R)*
6	Switch object	Switch object	1 Bit	C, T, (R)*
	Signal mode	Signal object		
7	Operation mode	Operation mode	1 Bit	W, C, T, (R)*
8	Alarm	Alarm	1 Bit	W, C, T, (R)*

Objects marked with *: object value can be read out (set R-flag).

Description of objects

Object 0 switching:

1 bit object for sending a switch telegram. Within the master/extension mode operation (switching) the level of dimmed lighting will be deactivated with a switch object = 1 and activated with a switch object = 0 during a detected movement. This ensures that a movement can also be detected when the lights are switched On.

Object 1 valuator:

1 byte object for sending a value telegram. Within the master/extension mode operation (valuator) the level of dimmed lighting will be deactivated with a value object = 1 ... 255 and activated with a value object = 0 during a detected movement. This ensures that a movement can also be detected when the lights are switched On.

Object 1 light scene extension:

1 byte object for sending a light scene extension telegram.

Object 2 disable:

1 bit object to switch the disable mode ON or OFF. The disable object has a higher priority than the internal slide switch.

Object 3 level of dimmed lighting:

1 bit object to switch between brightness dependent or independent movement detection.

Level of dimmed

lighting object value = 0: level of dimmed lighting acc. to ETS-parameter "Level of dimmed lighting"

lighting object value = 1: brightness independent movement detection

5 Description of objects

Object 4 movement (event signal to master, event signal from extension):

1 bit object for communication between master and extension. The movement object is only visible with application "master" and "extension input".

Object 5 event signal:

1 bit object for sending an event signal telegram in the monitoring mode.

Object 6 switch object / signal mode:

1 bit object for sending a switch telegram in the monitoring mode.

Object 7 operation mode:

1 bit object for switching between monitoring and the lighting mode within the parameterized operation modes:

- signal mode / switching + lighting mode
- signal mode / valuator + lighting mode
- signal mode / light scene retrieval + lighting mode

In case the T-flag is set in this object, an acknowledge telegram acc. to the actual object value can be sent.

This objects is only visible with a mixed operation (signal mode/lighting mode).

Object 8 alarm:

1 bit object for sending an alarm report in form of an ON or OFF telegram in case that the cover is removed.

Further functions

Walking test:

The walking test is used to adjust the sensivity of the movement detector when the device is put into operation. It is no operation mode, it should be inactive after starting the device.

The walking test function will be activated after removing and putting on again the cover or after a bus reset, if:

1. the ETS parameter "walking test activated" Yes/No is fixed to Yes and
2. the potentiometer for the level of dimmed lighting is turned to the max. and
3. the potentiometer for additional sending delay is turned to "-50 %" (zero position).

The walking test function will be deactivated after removing and putting on again the cover or after a bus reset, if:

1. the ETS parameter "walking test activated" Yes/No is fixed to No or
2. the potentiometer for the level of dimmed lighting is not turned to the max. or
3. the potentiometer for additional sending delay is not turned to "-50 %" (zero position).

Removal recognition – event signal after removal:

When the cover is removed from the BCU a report in form of an ON or OFF telegram can be released via the alarm object.

Alternatively, this function can be disabled by ETS parameter "alarm function disabled".

Signal operation:

In the signal operation mode, the movement detector reacts more insensitive to detected movements. The criterion for releasing an event signal telegram is the number X of movements within a fixed time period (monitoring time).

In this operation mode a configuration as master and extension input is not possible.

Every device works separately and sends, after detection and evaluation of the movement, a telegram via the event signal object to e.g. a display, signal panel, visualization etc.

The signal operation mode can be both, just single mode as well as mixed with lighting modes. In the mixed operation mode it can be switched between the modes via the operation mode object (object 7).

Master unit A 00201 / extension unit A 00301

The automatic switch can be used as a single unit, as a master or an extension.

Thus several automatic switch can be used in order to enlarge the detected area.

The automatic switch can be combined with several automatic switch standard (application extension unit) or with several universal presence detectors.

With the combination of these applications it is possible to have one or several extension units (satellites) to one master unit.

Additionally to the features of the application single unit there is one more object the so-called movement object.

That is the object used for the communication between the master and the extension unit.

Every extension unit receives the real switch telegram of the master unit by the object switch (status). That is necessary for the extension to know the real switch status of the master.

Note: In the project design you have to take care that the switch objects of the devices (master/extensions) and the movement objects are connected together.

After commissioning or after bus voltage recovery the device is blocked for about 80 sec. During that time no movements can be detected.

Physical Sensors

Presence Detector – Standard



2

	Ref.-No.
KNX presence detector, standard	3360
ETS-product family:	Physical sensors
Product type:	Movement

- 3
- The standard presence detector can be operated in two different modes:
- indoor presence: presences detector function mode
 - indoor movement detection, ceiling mounted detection mode

In both modes the device offers two output channels which can be parameterized separately.

Changing between the operation modes requires re-programming via ETS. The standard presence detector can only be used as a stand-alone device and should be exclusively mounted to the room ceiling in order to monitor the area below.

The purpose of a presence detector is to switch On e.g. the light when a movement is detected. Depending of a preset brightness threshold, it switches OFF again if there is sufficient brightness without artificial light or in case nobody is present any longer.

4

Technical data:	
Supply	
Voltage:	24 V DC (+6 V / -4 V)
Power consumption:	typical 150 mW
Connection:	KNX connection block
Input	
Opening angle:	360°
Nominal mounting height:	2.50 m
Nominal detection range	
at desk height:	approx. 5 m dia.
at floor level:	approx. 8 m dia.
No. of lences/detection levels:	80/6
Protection:	IP 20
Behaviour at voltage drop	no response
	Active movements detected or running delays will be disregarded and not continued after bus voltage recovery.
Behaviour at voltage recovery	depending on the used mode
	thermal movement detection immunity time: approx 40 s
Operation temp.:	-5°C ... +45°C
Storage temp.:	-25°C ... +70°C
Mounting:	plug onto flush-mounted bus coupler
Notes:	<ul style="list-style-type: none"> • The device shall not be mounted in the close vicinity of heat sources, e.g. lamps. Also the vicinity of fans, radiators, or ventilating ducts can cause unwanted triggering. • Install the internal brightness sensor at the side opposite to the window to avoid unwanted influences of scattered light.

5 Description of software application:

- Free assignment of the switching, value transmitter and light mood extension functions of the two outputs.
- Presence detector or ceiling mounted detector application. Changing the mode requires reprogramming via ETS.
- Potentiometers for setting the twilight value and the additional time delay.
- Manual operation is possible via the trigger object.
- The lock-out time after releasing a telegram can be adjusted.
- The twilight value and the teach-in function can be parameterized for each output. If the twilight value potentiometer acts on both outputs, setting the twilight value for output 1 will be sufficient.
- Cyclical transmitting during detection is possible (base and factor)
- Telegrams at the beginning and at the end of detection selectable.
- Telegrams at the beginning and the end of blocking selectable.
- Additional time delay can be adjusted. The overall delay results from addition of the standard time delay (10 s) and the additional time delay.
- The behavior at bus voltage recovery can be parameterized for each output separately.
- Alarm message after unplugging the device from the BCU is possible (1 Bit/1 Byte).

Objects:

Number of addresses:	30
Number of assignments:	30
Communication objects:	8

Object	Name	Function	Type	Flag
Function: Switching**				
0	Output 1	Switching	1 Bit	C, W, T, (R)*
1	Output 2	Switching	1 Bit	C, W, T, (R)*
Function: Value transmitter**				
0	Output 1	Value	1 Byte	C, W, T, (R)*
1	Output 2	Value	1 Byte	C, W, T, (R)*
Function: Light scene extension**				
1	Output 1	Light scene extension	1 Byte	C, W, T, (R)*
2	Output 2	Light scene extension	1 Byte	C, W, T, (R)*
Function: Teach-in				
2	Output 1	Teach-in	1 Bit	C, T, (R)*
3	Output 2	Teach-in	1 Bit	C, T, (R)*
Function: Blocking				
4	Output 1	Blocking	1 Bit	C, T, (R)*
5	Output 2	Blocking	1 Bit	C, T, (R)*
Function: Trigger object				
6	Output 1 and 2	Trigger object	1 Bit	C, W, T, (R)*
1 Bit data format alarm function:				
7	Alarm	Switching	1 Bit	C, W, T, (R)*
1 Byte data format alarm function:				
7	Alarm	Value	1 Byte	C, W, T, (R)*

Objects marked with *: Object value can be read out (set R-flag!)

Objects marked with **: The functions 'no function', 'switching', 'value transmitter' and 'light mood extension' can be selected for both outputs. The names of the communication objects and the object table will change accordingly (dynamic object structure).

For further description please refer to the universal presence detector (3360-1)!

Physical Sensors

Presence Detector – Universal

1



2

	Ref.-No.
KNX presence detector, universal	3360-1
ETS-product family:	Physical sensors
Product type:	Movement

3

The universal presence detector is used for the detection of presence (presence detector mode), for the detection of movements (ceiling-mounted detector mode) and for the supervision of signalling telegrams (signalling mode) in rooms.

In these three modes of operation, the device offers 4 output channels, two of which can be active in one mode of operation respectively and which can be independently parameterised. The modes of operation, presence detector, ceiling-mounted detector and signalling mode can be defined when the device is parameterised with the ETS software.

The detector is provided with an alarm function which is activated when the device is removed from the bus coupler.

The universal presence detector can be used as a stand-alone unit, as master (main unit) or slave unit (extension unit) and should be mounted exclusively under the room ceiling from where it monitors the area below.

The detector is equipped with a passive infrared sensor (PIR) and responds to thermal movements triggered by persons, animals or objects.

To extend the detection range, several presence detectors can be used in the same room by combining a device parameterised as master with several other devices parameterised as slaves.

It is also possible to connect the presence detector to a flush-mounted automatic switch "comfort", parameterised as a slave unit or with the flush-mounted automatic switch "standard" in an extension application.

The purpose of a presence detector is to switch on the light depending on brightness when a movement is detected, and to switch it off when it is no longer needed. This is the case when there is sufficient brightness without any additional artificial light, and when nobody is present anymore.

This means that the presence of a person is detected depending on a preset brightness.

4 Technical data:

Supplying	
Voltage:	24 V DC (+6 V / -4 V)
Power consumption:	typical 150 mW
Connection:	KNX connection block
Input	
Opening angle:	360°
Nominal mounting height:	2.50 m
Nominal detection range	
at desk height:	approx. 5 m dia.
at floor level:	approx. 8 m dia.
No. of lenses/detection levels:	80/6
Protection:	IP 20
Behaviour at voltage drop	no response
	Active movements detected or running delays will be disregarded and not continued after bus voltage recovery.
Behaviour at voltage recovery	depending on the used mode
	thermal movement detection immunity time: approx 40 s
Operation temperature:	-5°C ... +45°C
Storage temperature:	-25°C ... +70°C
Mounting:	plug onto flush-mounted bus coupler

- Notes:
- The device shall not be mounted in the close vicinity of heat sources, e.g. lamps. Also the vicinity of fans, radiators, or ventilating ducts can cause unwanted triggering.
 - Install the internal brightness sensor at the side opposite to the window to avoid unwanted influences of scattered light.

5 Description of software application:

- Toggling between two independent operation modes with two outputs each possible.
- For each operation mode it is possible to adjust the device as a presence detector, a ceiling mounted detector or to an event signal mode. For switching over of the different operation modes during active operation, the device offers an operation mode object.
- The free assignment of the functions “switching”, “dimming value transmitter”, “light scene extension” and “report” (only within operation mode “event signal mode”) to the four outputs is possible. Additionally for output 1: “temperature value transmitter” or “brightness value transmitter”.
- Application modes: single unit, master or slave. Different combinations can be realized (e.g.: Presence detector universal as master with presence detector standard or automatic switch (standard/universal) as slave).
- The integrated potentiometers for the twilight value and the additional time delay act on one parameterized output.
- Within the application mode as a master, the evaluation of the twilight value can be carried out in the master and the slave or in the master only. Removal alarm after with drawal of the device from the flush-mounted bus coupler possible (1 bit/1 byte).
- Twilight value and teach-in function can be parameterized for each output.

Objects:

Number of addresses:	20
Number of assignments:	21
Communication objects:	12

Object	Name	Function	Type	Flag
Function: Switching***				
0 – 3	Output 1 – 4	Switching	1 Bit	C, W, (T**), (R)*
Function: Dimming value transmitter***				
0 – 3	Output 1 – 4	Value	1 Byte	C, W, (T**), (R)*
Function: Light scene extension***				
0 – 3	Output 1 – 4	Light scene extension	1 Byte	C, W, (T**), (R)*
Function: Signaling***				
0 – 3	Output 1 – 4	Signaling	1 Bit	C, W, T, (R)*
Function: Temperature value transmitter (only for output 1)****				
0	Output	Temperature value	2 Byte	C, (W, T)**, (R)*
Function: Brightness value transmitter (only for output 1)****				
0	Output 1	Brightness value	2 Byte	C, W, (T**), (R)*

5 Description of software application:

Object	Name	Function	Type	Flag
General				
4	Movement	Communication with main/extension unit	1 Bit	C, W, T, (R)*
5	Mode	Mode of operation change-over	1 Bit	C, W, T, (R)*
6	Inhibit	Inhibit object 1	1 Bit	C, W, (R)*
7	Inhibit	Inhibit object 2	1 Bit	C, W, (R)*
8	Teach-In	Teach-in object 1	1 Bit	C, W, (R)*
9	Teach-In	Teach-in object 2	1 Bit	C, W, (R)*
10	Twilight level	Brightness-(in)dependent	1 Bit	C, W, (T**), (R)*
Alarm function				
11	Alarm	Switching	1 Bit	C, W, T, (R)*
12	Alarm	Value	1 Byte	C, W, T, (R)*

* : For the objects marked (R), the object status can be read out (set R-Flag).

** : These flags are set or removed dependent on the type of application.

*** : The “no function”, “switching”, “dimming value transmitter”, “light scene extension” and “signaling” (only in signaling mode) functions can be selected per output. The names of the communication objects and the object table (dynamic object structure) change accordingly.

**** : “Temperature value transmitter” and “Brightness value transmitter” can only be selected for output 1. The names of the communication objects and the object table (dynamic object structure) change accordingly.

• Modes of Operation

Ceiling-mounted detector mode

In the ceiling-mounted detector mode, the device detects movements and will transmit the message parameterised at the beginning of detection if the brightness value measured is below the twilight value set. If the message was transmitted at the beginning of detection, the device will work independently of the ambient brightness. If no more movements are detected, the device will transmit the parameterised message at the end of detection after the preset overall transmit delay (standard transmit delay (10 s) + additional transmit delay) has elapsed.

Independent of a movement detection, the light can also be switched on or off if the ceiling-mounted detector is disabled, upon bus voltage recovery, or by the trigger object (refer to the description of the trigger function).

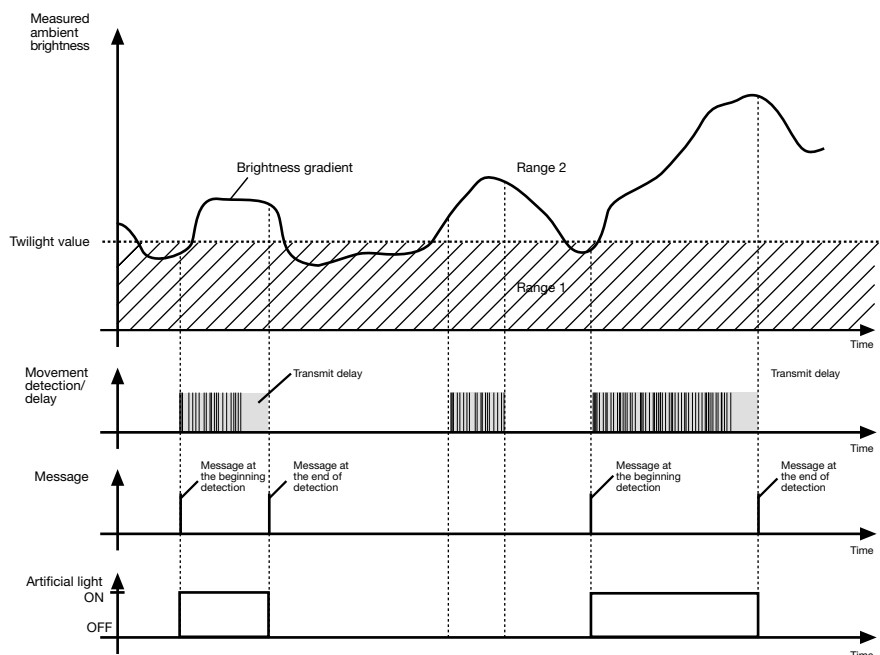

The brightness limit between range 1 and range 2 is determined by the twilight value which can be parameterised. If the ambient brightness measured falls below this value and a movement is detected, the ceiling-mounted detector will switch on the artificial light. Range 2 characterises the brightness in the room at which the room is sufficiently illuminated and, therefore, no artificial light needs to be switched on. If the ambient brightness is within this range and the device detects no movement, no artificial light will be switched on.

The “sensitivity” parameter determines the intensity of the movement impulses to detect a movement. Thus, to avoid erroneous switching, for example, it is possible to reduce the sensitivity of the PIR sensors.

If the twilight value has been parameterised to "brightness-independent", the artificial light will always be switched on without any monitoring of the ambient brightness once a movement is detected.

5 Presence detector mode

In the presence detector mode, the device detects the presence of a person and will transmit the message parameterised at the beginning of detection if the brightness value measured is below the twilight value set.

If no more presence is detected now and the preset overall transmit delay (standard transmit delay (10 s) + additional transmit delay) has elapsed, or if the preset twilight value has been exceeded, for example, by double the value for at least 10 minutes (depending on the software), the presence detector will transmit the parameterised message at the end of detection.

The differences in the functionality compared with the ceiling-mounted detector mode are in the processing of:

a) the movement signal:

Contrary to the ceiling-mounted detector function, only a succession of movement impulses leads to presence detection.

b) the brightness signal:

The adjustable brightness range to be evaluated as twilight value is wider than for the ceiling-mounted detector mode.

Only after double the value of the preset twilight value (switch-off brightness) is exceeded, the configured message will be transmitted at the end of the detection event after at least 10 minutes, even though the presence of a person is detected.

This switch-off brightness can be altered in the parameters through a correction value.

c) the combination in the evaluation of the movement and brightness impulses:

The light will be switched on when it is needed, i.e. after the presence of a person has been detected and a brightness value below the preset twilight value has been measured.

The light will be switched off when it is no longer needed, i.e. nobody is present any longer, or the brightness is sufficient without additional illumination.

Independent of a movement detection, the light can also be switched on or off if the presence detector is disabled, upon bus voltage recovery, or by the trigger object (refer to the description of the triggering function).

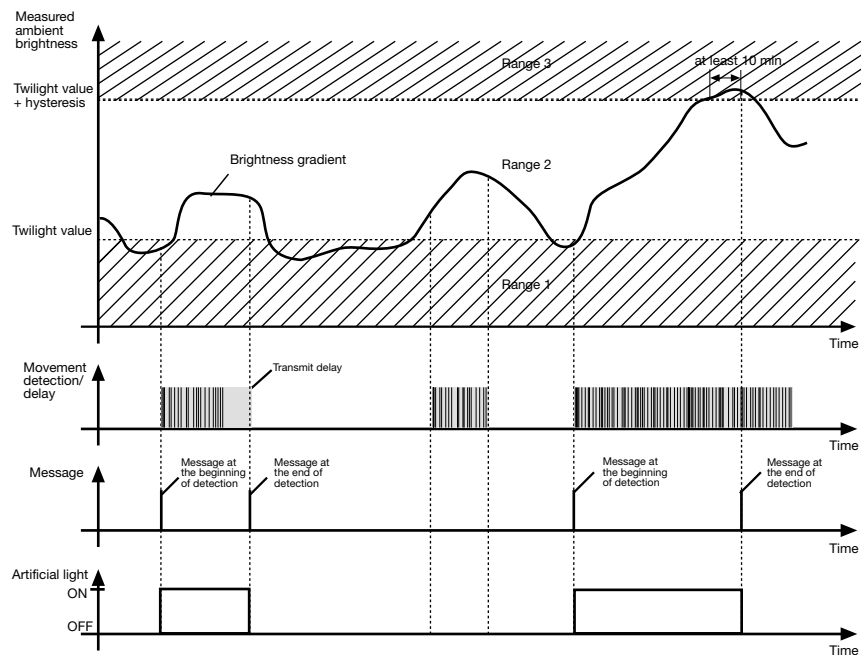

The brightness limit between range 1 and range 2 is determined by the twilight value which can be parameterised. If the ambient brightness measured falls below this value and the presence of a person is detected, the presence detector will switch on the artificial light.

Range 2 characterises the brightness in the room the presence detector is to adjust. If the ambient brightness is within this range and the device detects a new movement, no artificial light will be switched on. The border between ranges 2 and 3 is determined by the twilight value plus the hysteresis (refer to the "Hysteresis and correction value" description further below). If the ambient brightness measured exceeds this brightness threshold permanently, the artificial light will be switched off after 10 minutes at the earliest. The time until the switch-off moment can be longer than 10 minutes if the ambient brightness does not permanently exceed the threshold between ranges 2 and 3, i.e. if the brightness sometimes decreases or sometimes increases, respectively. This switch-off time serves to "debounce" short-time light reflections and prevents erroneous switching of the light.

If the twilight value has been parameterised to "brightness-independent", the artificial light will always be switched on without any monitoring of the ambient brightness once the presence of a person is detected.

5 Hysteresis and correction value:
 The border between ranges 2 and 3 (switch-off threshold) can be parameterised and adapted to the ambient conditions. If the artificial light is found to switch off too early (too late) the switch-off threshold can be shifted up (down). Such shifting of the switch-off threshold is described by the correction value ("switch-off hysteresis correction").
 In the standard case, the hysteresis is double (100 %) the parameterised twilight value. If the threshold is to be shifted down, a negative value must be selected. If the threshold is to be shifted up, parameterise a positive value. The hysteresis must be specified as a percentage of the parameterised twilight value to have an additional reference. The following illustration shows various parameterisation examples.

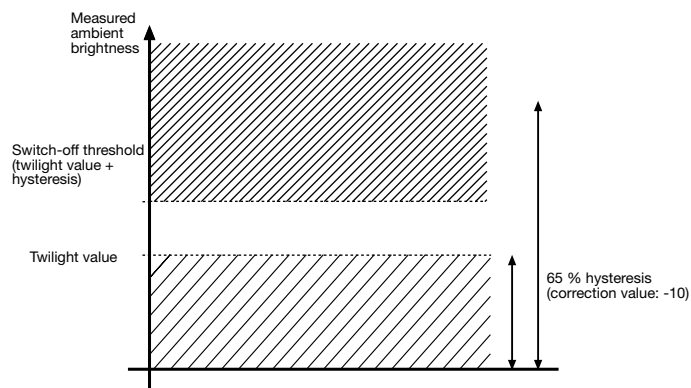
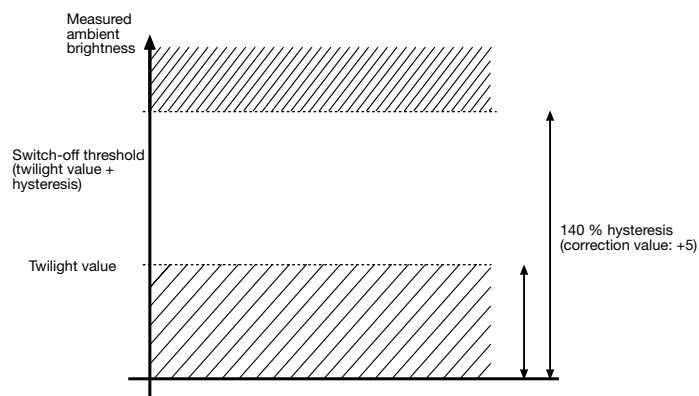
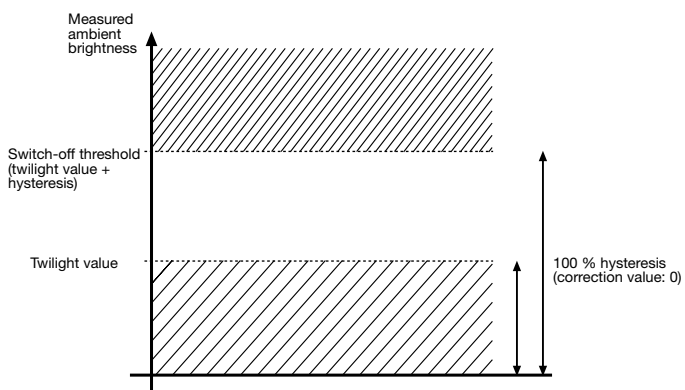

5

• Teach-in function

The teach-in function allows a direct local, object-controlled adaptation of the twilight value (switch-on threshold) to the ambient conditions. For this purpose, a separate teach-in object is available for each output.

In such case, the device accepts as the new twilight value the currently measured ambient brightness 3 s after an update to the teach-in object. The effect of the delay of these 3 s is that some actuators can be activated in parallel by the message for the triggering of the teach-in function to set a different illumination situation before the new twilight value is saved. So as not to influence the brightness value by any actions of the presence detector (e.g. on, off, value messages, cyclic transmitting, inhibit messages, etc.) within the delay of the 3 s, presence and movement evaluation or brightness control, respectively, will be disabled until the new twilight value is accepted.

The polarity of a teach-in message can be parameterised. Depending on the parameterisation, you can switch back to the originally parameterised twilight value by the reception of the opposite object value (teach-in function inactive). In this case, you will lose the twilight value taught in before. However, if the teach-in mode has been parameterised to "1"- and "0"-active, you cannot switch back to the twilight value originally programmed by the ETS while the device is in operation. In such case, you can only restore the original value by re-programming. Several successively received updates to the teach-in object (teach-in function active) each time cause a new twilight value saving process. The twilight value taught in by the teach-in function will be kept permanently saved in the EEPROM of the bus coupler until a new teach-in message is received so that a bus voltage failure will not lead to the loss of the value taught in.

If a new twilight value has been set for a channel by the teach-in function, this value cannot be altered by the twilight value potentiometer. The inhibit function has no influence on the teach-in function.

Physical Sensors

Brightness Detector

1



2

	Ref.-No.
KNX brightness sensor with 3 barriers	
brightness sensor	2160 REG
ETS-product family:	Physical sensors
Product type:	Brightness
Series embodiment (SE)-device (2 units)	

3

This 3 barrier brightness sensor controls switching and dimming actuators depending on the ambient brightness. The level of brightness is recorded by a light sensor which is fitted externally and connected via a cable with the brightness sensor. The device is very suitable for applications where a comfortable brightness-dependent lighting control has to be implemented. Up to four different brightness areas can be surveyed with the device. The device offers two applications:

- brightness sensor with 3 barriers
- brightness sensor with 4 scenes

4

Technical data

Supply	
Voltage:	24 V DC (+6 V / -4 V)
Power consumption:	max. 150 mW
Connection:	KNX connection block
Input	
Number:	1 light sensor
Connection:	external, length max. 100 m
Protection:	IP 20 (control unit), IP 54 (light sensor)
Operation temperature:	-5°C ... +45°C (control unit)
Storage temperature:	-40°C ... +70°C (light sensor)
Mounting:	onto DIN rail 35 x 7,5

5 Description of application 1. Brightness sensor with 3 barriers

With this application the brightness sensor takes over the function of a 3-barrier limit value switch with a range of adjustment from 1 to 10 000 Lux. Each limit value can be adjusted separately. The transmission behaviour of each channel can be parameterized when it is below or above a barrier. Via a 1 Byte object any combination of channels can be deactivated or activated temporarily.

Objects

Number of addresses: 5
 Number of assignments: 5
 Communication objects: 4

Object	Name	Function	Type	Flag
0	Channel 1	Switching at barrier ch. 1	1 Bit	R, T
1	Channel 2	Switching at barrier ch. 2	1 Bit	R, T
2	Channel 3	Switching at barrier ch. 3	1 Bit	R, T
3	Stop	Reception message stop	1 Byte	W, T

Table for object 3 stop (blocking):

value of the blocking object (type 1 Byte)		transmitting behaviour of the channels A = active G = blocked (i.e. any transmitting on the corresponding channel object is suppressed)		
decimal	binary	channel 1 (object 0)	channel 2 (object 1)	channel 3 (object 2)
0	00000000			
1	00000001	A	A	A
2	00000010	G	A	A
3	00000011	A	G	A
4	00000100	G	G	A
5	00000101	A	A	G
6	00000110	G	A	G
7	00000111	A	G	G
255	11111111	G	G	G
	Bit 3 to 7 have no function	G	G	G

Description of application 2. Brightness sensor with 4 scenes

With this application the device takes over the function of a brightness controlled scene component with a range of adjustment from 100 to 20 000 Lux. Four brightness areas can be defined by three different switching levels. Thereby a light scene, consisting of three switching and a value object, is assigned to each brightness area. If the measured brightness value for an adjustable delay time is in an area, the parameterised switching and value messages are transmitted on the bus. Additionally, each scene object can be force-controlled over a so-called blocking object. If a value is transmitted to this object, objects 0 to 3 send their actual values. The behaviour of blocking can be parameterised.

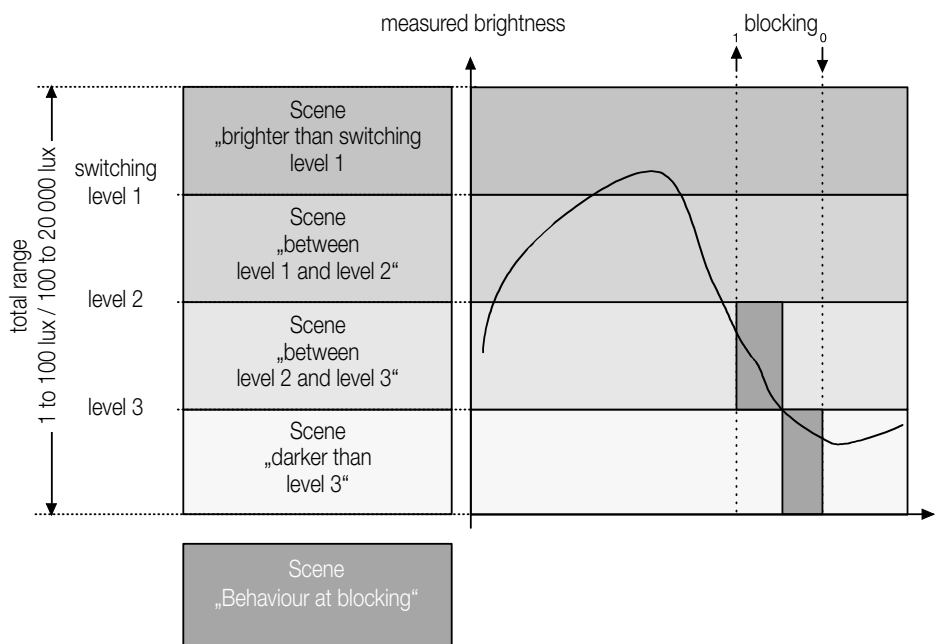

5

Objects

Number of addresses:	5
Number of assignments:	5
Communication objects:	5

Object	Name	Function	Type	Flag
0	Value object	Send telegram value	1 Byte	R, T
1	Switch object 1	Send telegram switch	1 Bit	R, T
2	Switch object 2	Send telegram switch	1 Bit	R, T
3	Switch object 3	Send telegram switch	1 Bit	R, T
4	Block	Reception teleg. block	1 Byte	W, T

Table for object 4 blocking:

value of the blocking object (object 4 / type 1 Byte)		transmitting behaviour of the channels A = active (0) G = blocked (i.e. transmitting object adopts the status which is adjusted on the parameter page "behaviour when blocking" after reception of the corresponding blocking bit) (1)			
decimal	binary	object 3	object 2	object 1	object 0
0	00000000	A	A	A	A
1	00000001	A	A	A	G
2	00000010	A	A	G	A
3	00000011	A	A	G	G
4	00000100	A	G	A	A
5	00000101	A	G	A	G
6	00000110	A	G	G	A
7	00000111	A	G	G	G
8	00001000	G	A	A	A
9	00001001	G	A	A	G
10	00001010	G	A	G	A
11	00001011	G	A	G	G
12	00001100	G	G	A	A
13	00001101	G	G	A	G
14	00001110	G	G	G	A
15	00001111	G	G	G	G
16 to 255	Bit 4 to 7 have no function	A	A	A	A

Physical sensors

Room temperature Controller

1



2

	Ref.-No.
KNX room temperature controller with integrated BCU	
ETS-product family:	Heating, A/C, ventilation
Product type:	Regulator
ranges CD 500/CD plus	
ivory	2178
white	CD 2178 WW
blue	CD 2178 BL
brown	CD 2178 BR
grey	CD 2178 GR
light grey	CD 2178 LG
red	CD 2178 RT
black	CD 2178 SW
ranges LS 990/LS plus/Stainless Steel/Aluminium/Anthracite/Gold/Chrome	
ivory	LS 2178
white	LS 2178 WW
light grey	LS 2178 LG
Metal versions	
stainless steel	ES 2178
aluminium	AL 2178
anthracite	AL 2178 AN
gold	GO 2178
chrome coloured	GCR 2178
ranges AS 500/A 500/A plus	
ivory	A 2178
white	A 2178 WW
aluminium	A 2178 AL

3

The temperature controller with integrated BCU is used for a single room temperature control. Dependent on the operation mode and the actual temperature it controls a heating or cooling system by the KNX.

It is possible to choose between different control principles as a continuous PI control, switching PI control (pulse width modulation) and a switching two-step control.

The actual room temperature is measured by the integrated temperature sensor.

In addition to the basic system for heating or cooling, an additional heating or cooling system can be implemented whereby the control principles can be different. This is practicable when a room should be heated up faster due to cold temperatures (basic system: floor heating; additional system: electrical heating).

The temperature controller knows five operation modes which are comfort, stand-by, night, frost / heat protection and disabled controller.

1



LS 2178 TS WW



LS 2178 ORTS WW

2

	Ref.-No.
KNX room temperature controller with integrated BCU and push-button interface	
ETS-product family:	Heating, A/C, vent. or binary input, 4-gang
Product type:	Regulator
ranges CD 500/CD plus	
ivory	2178 TS
white	CD 2178 TS WW
blue	CD 2178 TS BL
brown	CD 2178 TS BR
grey	CD 2178 TS GR
light grey	CD 2178 TS LG
red	CD 2178 TS RT
black	CD 2178 TS SW
ranges LS 990/LS plus/Stainless Steel/Aluminium/Anthracite/Gold/Chrome	
ivory	LS 2178 TS
white	LS 2178 TS WW
light grey	LS 2178 TS LG
Metal versions	
stainless steel	ES 2178 TS
aluminium	AL 2178 TS
anthracite	AL 2178 TS AN
gold coloured	GO 2178 TS
chrome	GCR 2178 TS
ranges AS 500/A 500/A plus	
ivory	A 2178 TS
white	A 2178 TS WW
aluminium	A 2178 TS AL
KNX room autostat with integrated BCU and push-button interface (without any operational elements)	
ETS entry similar to 2178 TS	
all ranges as above	.. 2178 ORTS ..

3

The temperature controller with integrated BCU is used for a single room temperature control. Dependent on the operation mode and the actual temperature it controls a heating or cooling system by the KNX.

It is possible to choose between different control principles as a continuous PI control, switching PI control (pulse width modulation) and a switching two-step control.

The actual room temperature can be measured either by the integrated temperature sensor or by an external one which is connected to channel 4 of the integrated push-button interface. In addition to the basic system for heating or cooling, an additional heating or cooling system can be implemented whereby the control principles can be different. This is practicable when a room should be heated up faster due to cold temperatures (basic system: floor heating; additional system: electrical heating).

The temperature controller knows five operation modes which are comfort, stand-by, night, frost / heat protection and disabled regulator.

The integrated 4-gang push-button interface has similar features as the regular 2-/4-gang push-button interface (→ please refer to ref.-no. 2076-2T / 4T). In addition, channel 4 can also be used to connect an external sensor, e.g. floor temperature sensor.

The connection of 230 V signals or other external voltages to the inputs is not allowed.

The temperature controller is also available in a version without any operational element as rotary knob, presence push-button or LED's. This version is called autostat. The functions of the autostat are exactly the same, it is operated solely via bus telegrams. This version is recommended for e.g. for public buildings where you should avoid the manual operation of the sensor.

3

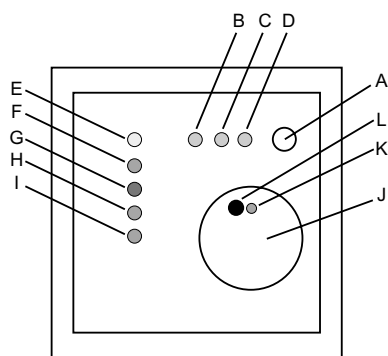

- A: presence push-button
- B: status LED green: comfort mode
- C: status LED green: standby mode
- D: status LED green: night mode
- E: status LED yellow: energy request
- F: status LED red: operation mode heating
- G: status LED blue: operation mode cooling
- H: status LED red: frost/heat protection
- I: status LED red: dew point
- J: rotary knob for set point adjustment
- K: programming LED (beneath knob)
- L: programming push-button (beneath knob)

Note:

If 1.5 mm² wires are used for the push-button interface, a deep wall box should be used !

4

Technical data:

KNX supply

Voltage:

21 – 32 V DC

Power consumption:

typical 150 mW

Connection:

bus terminal (KNX type 5.1)

Response to voltage failure

Bus voltage only:

all object values are deleted

– temperature sensor: no reaction

– push-button interface: no reaction

Bus and mains:

Response to recovery

Bus voltage only:

– temperature sensor: restart, transmission of values and status according to parameters

– push-button interface: according to parameters

Inputs

Number:

up to 4 (depending on parameterisation)

Line length:

– binary inputs: max. 5 m

– external sensor: 4 m pre-fabricated (e.g. ref.-no. FF 7.8) extendable to 50 m

Scanning voltage:

continuous signal

Loop resistance:

max. 2 kOhm for safe detection of "1" signal

Temperature sensor

Range of measurement:

0°C ... +40°C

Resolution:

0.1 K

Air humidity:

0 ... 95 %

Protection:

IP 20

Ambient temperature:

–5°C ... +45°C

Storage/transport temperature:

–25°C ... +70°C (storage above +45°C results in shorter life time)

For further details of the push-button interface please refer to ref.-no. 2076-2 T / 4 T !

4 Connection proposal for push-button interface

Example 1: application with 4 binary inputs
(recommended wiring J-Y(St)Y 2 x 2 x 0.8 mm)

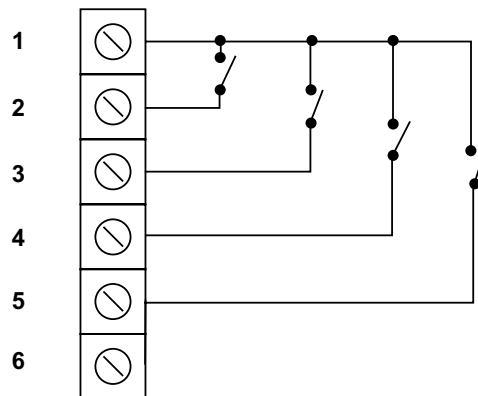

Example 2: application with 2 binary outputs (for LED's), 1 binary input
(recommended wiring J-Y(St)Y 2 x 2 x 0.8 mm),
external temperature sensor (pre-fabricated wires,
extend with 1.5 mm² up to 50 m)

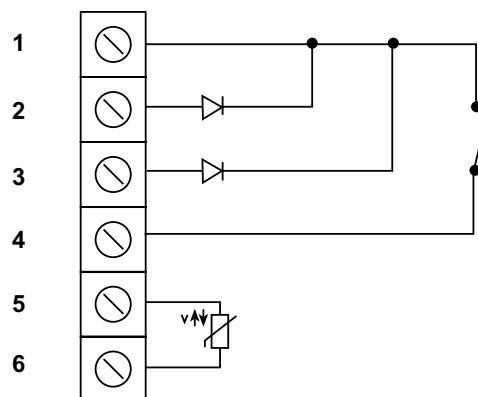

5 Scope of functions

A) Push-button interface

General

- Free assignment of the switching, dimming, blind/shutter, valuator functions to the 4 inputs.
- Blocking object to enable/disable individual inputs.
- Delay times upon bus voltage recovery and debouncing time centrally adjustable.
- Behaviour on bus voltage recovery adjustable.
- Limit value for telegrams adjustable in general, for all inputs.

Switching function

- Two independent switching objects are available for each input.
- Command upon rising and falling edges separately selectable (ON, OFF, TOGGLE, no response).
- Independent cyclic sending of the switching objects selectable as a function of the edge or of the object value, respectively.

Dimming function

- Single-level or two-level operation possible.
- Time between dimming and switching and dimming step width adjustable.
- Repetition of telegram and sending stop telegram possible.

Blind/shutter function

- Command upon the rising edge adjustable (no function, UP, DOWN, TOGGLE).
- Operating concept adjustable (short – long – short or long - short).
- Time between short-time mode and long-time mode adjustable (for short – long – short only).
- Louvres adjustment time (for louvers adjustment by one single push button action).

5

Transmitter and light scene extension function

- Edge (push-button as normally-open contact, push-button as normally-closed contact, switch) and a certain value can be parameterised.
- Value changing possible in case of push-button mode by pressing push-button for a longer time period.
- For light scene extension with memory function, saving of light scene is also possible without previously recalling it.

Temperature/brightness valuator functions

- Edge (push-button as normally-open contact, push-button as normally-closed contact, switch) and a certain value can be parameterised.
- Value changing possible in case of push-button mode by pressing push-button for a longer time period.

Outputs

- Independent switching of max. 2 outputs
- Optional output either of a 1 bit control output of the temperature controller or a separate output.

B) Room temperature controller

General

- 5 operation modes: comfort, standby, night, frost/heat protection and disable controller.
- Changeover between modes by either a 1 byte KONNEX object (recommended) or by separate 1 bit objects.

Heating/cooling

- Operation modes: Heating, cooling, heating and cooling always with or without additional system
- PI controller (continuous or switched PWM) or 2step controller adjustable.
- Continuous (1 byte) or switched (1 bit) control output.
- Controller parameter for both principles adjustable.

Set points

- To each operation mode a temperature set point can be assigned.
- The set points for the additional system are derived by a defined step to the basic system.
- Set point adjustment possible either by rotary knob or ETS objects.

Functionality

- Automatic or object dependent changeover between heating and cooling.
- The operation of the controller can be disabled by an object.
- Complete (1 byte) or partial (1 bit) status information can be transmitted onto the bus.

Room temperature measurement

- Temperature measurement either by internal or external sensor.
- Evaluation of external temperature input to the internal value adjustable.
- The actual and set point temperature can be transmitted to be bus (also cyclical) after an adjustable deviation.
- Temperature alarm with upper and lower limit value possible via two separate objects.

Control value output

- Separate or common control value output via one or two objects (with heating and cooling mode).
- Control value output can be normal or inverted.
- Automatic sending of the control value output and the cyclic time are adjustable.

For further details of the functions/objects and the corresponding description, please refer to the complete product documentation which is available on our webpage!

Binary Inputs

Push-Button Interface

1

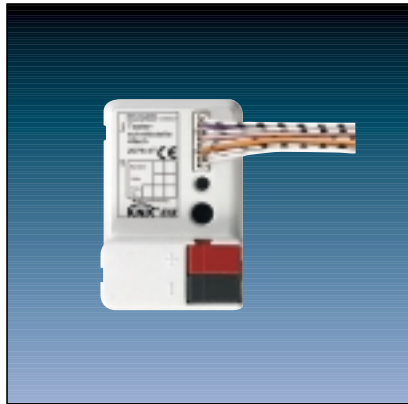
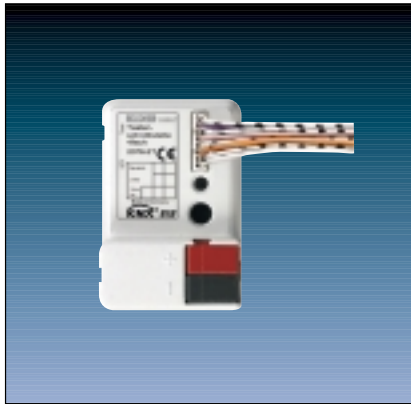

2

	Ref.-No.
KNX push-button interface,	
2-gang	2076-2 T
4-gang	2076-4 T
ETS-product family:	Input
Product type:	Binary input

3

The 2-channel (4-channel) push-button interface has 2 (4) independent channels which – depending on parameterization – can be used as inputs or alternatively as outputs. The push-button interface can therefore be used to poll its inputs for the switching state of up to 2 potential-free push-buttons/switches with a common reference potential and send the corresponding telegrams to the KNX. These may be telegrams for switching or dimming, shutter/blind control or value transmitter applications (dimming value transmitter, light-scene extension, temperature or brightness value transmitter). Moreover, 2 switching event counters or 1 pulse counter (only channel 1) are available. Channels 1 and 2 can be used alternatively as independent outputs for controlling up to two LED's. To increase the output current (cf. Technical Data), the channels can also be connected in parallel if they are parameterised alike. The outputs are short-circuit-proof and protected against overloading and false polarity.

Connection 230 V signals or other external voltages to the inputs is not permitted.

4

Technical data

KNX supply	
Voltage:	21 – 32 V DC SELV
Power consumption:	typ. 150 mW
Connection:	bus connection and branching terminal
Response to voltage failure	
Bus voltage only:	no response (outputs switching off)
Response to return of voltage	
Bus voltage only:	the response of the inputs and the outputs can be parameterised
Protection:	IP 20
Safety class:	III
Mark of approval:	KNX
Ambient temperature:	-5°C ... +45°C
Storage/transport temperature:	-25°C ... +70°C (storage above +45°C results in shorter lifetime)
Mounting position:	any
Minimum spacings:	none
Fastening:	e.g. placing into deep flush-mounting box (Ø 60 mm x 60 mm)

4 Technical data

Inputs

Number:	up to 2 (depending on parameterization: channel 1 to 2), 2076-2 T up to 4 (depending on parameterization: channel 1 to 4), 2076-4 T
Line length:	25 cm prefabricated, extendable to 5 m max.
Scanning voltage:	continuous signal
Loop resistance:	max. 2 kOhm for safe detection of a "1" signal (rising edge)

Outputs

Number:	up to 2 (depending on parameterization: channel 1 to 2)
Line length:	25 cm prefabricated, extendable to 5 m max.
Output current:	max. 0.8 mA per output channel (at 1.5 V, typ. for red low-current LED)
Output voltage:	typ. 1.5 V (e.g. red-low current LED) (5 V with outputs open circuit)

Outputs:

- Independent switching of max. 2 outputs
- Outputs parameterizable as n.o. contact (ON: output supplies current / OFF: output supplies no current) or as n.c. contact (ON: outputs supplies no current / OFF: output supplies current)
- Preferred state on return of bus voltage presettable
- For each output additional feedback and additional function possible:
- Presettable additional functions:
 - logic-operation function with 3 logic parameters
 - disabling function with presettable disabling behaviour of the relays
 - priority-position function to fix the priority of arriving switching telegrams
- Feedback object invertible
- Delay on return of bus voltage centrally presettable
- Turn-on delay and/or turn-off delay or timer function separately presettable for each output
- Output signal as flashing signal (flashing frequency parameterizable in 3 steps)

Note: For parallel connection of the outputs, the maximum total output current increases to 1.6 mA. In the event of parallel connection, outputs 1 and 2 must be parameterised exactly alike (none of the output signals flashing).
The outputs are short-circuit-proof, protected against overloading and false polarity.

Important: – Connect only potential-free switches or push-buttons to the inputs.
– To obtain sufficient signalling brightness, it is recommended to connect "low-current LED" to the outputs.

For detailed information please refer to the binary input REG devices shown on the following pages.

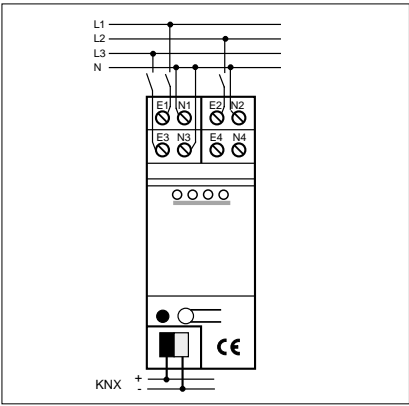

2

KNX universal binary input, 4-gang	Ref.-No. 2114 REG
ETS-product family:	Input
Product type:	4-gang binary input
Series embodiment (SE-) device (2 units)	

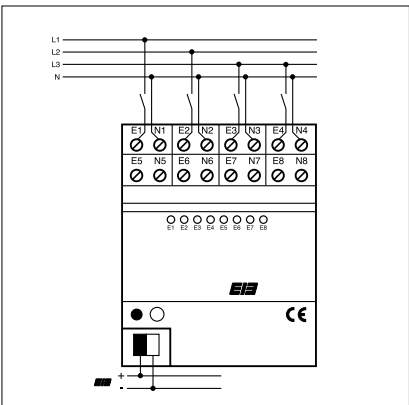
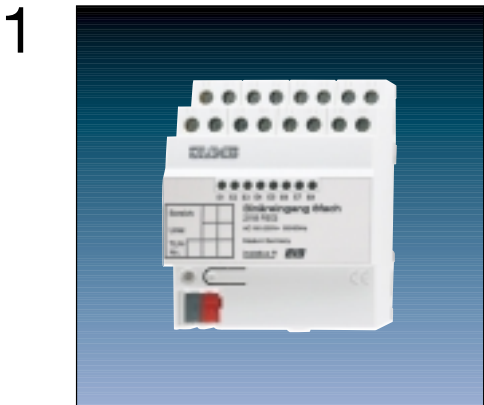

2

KNX universal binary input, 8-gang	Ref.-No. 2118 REG
ETS-product family:	Input
Product type:	8-gang binary input
Series embodiment (SE-) device (4 units)	

3 With its 4 (8) independent inputs, this binary input can collect 230 V signals and send messages to the KNX, depending on the parameter setting. These can, for example, be messages for switching, dimming (single-level or two-level operation) or for blind/shutter control. Also, it is possible to program certain functions such as dimming value transmitter, light scene extension as well as temperature or brightness transmitter, respectively. Various functions can be assigned to the 4 (8) inputs. In addition, inputs 1 and 2 can be parameterised with pulse or switching counter functions. Finally, the binary input offers a blocking function to enable or disable certain inputs.

4 Technical data

Supply	
Voltage:	24 V DC (+6 V / -4 V)
Power consumption:	
2114 REG:	150 mW
2118 REG:	max. 240 mW
Connection:	KNX connection block
Input	
Number	
2114 REG:	4
2118 REG:	8
Signal voltage	110 V ... 230 V AC \pm 10 %; 50/60 Hz
Signal current	approx. 7 mA at 230 V AC per input (max. glow discharge lamp current < 2 mA for reliable "0" recognition)
Signal length for pulse	Tmin. = 200 ms at a mark-to-space ratio of 1:1
"0"-signal	0 ... 70 V AC
"1"-signal	> 90 V AC
Input line length	100 m max. (unshielded)
Connection:	clamp bar
Behaviour at voltage drop	
only bus voltage	no reaction
only mains	a falling edge is detected; this response depends on the parameters
bus and mains	no reaction
Behaviour at voltage recovery	
only bus voltage	dependent on parameters
only mains	a rising edge is detected; this response depends on the parameters
bus and mains	dependent on parameters
Protection:	IP 20
Operation temperature:	-5°C ... +45°C
Storage temperature:	-25°C ... +70°C
Mounting:	on DIN rail 35 x 7.5

Notes:

- Different lines can be connected to the device.

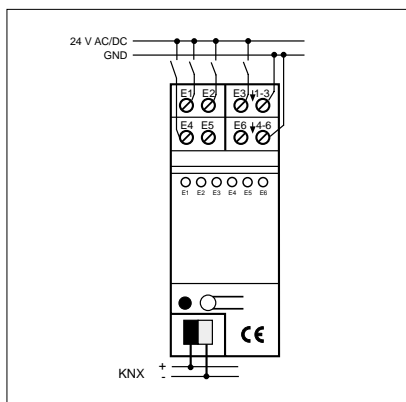
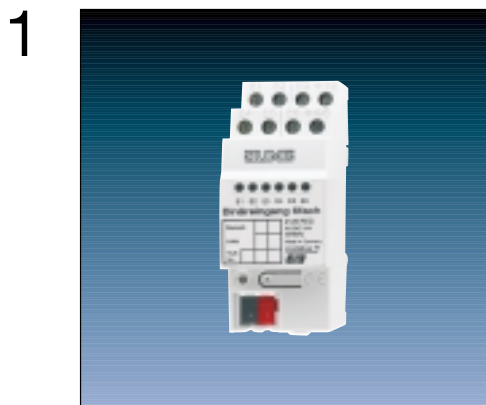

2

	Ref.-No.
KNX universal binary input, 6-gang	2126 REG
ETS-product family:	Input
Product type:	6-gang binary input
Series embodiment (SE-) device (2 units)	

3

With its six independent inputs, this binary input can collect 24 V signals and send messages to the KNX, depending on the parameter setting. These can, for example, be messages for switching, dimming (single-level or two-level operation) or for blind/shutter control. Also, it is possible to program certain functions such as dimming value transmitter, light scene extension as well as temperature or brightness transmitter, respectively. Various functions can be assigned to the six inputs.

In addition, inputs 1 and 2 can be parameterised with pulse or switching counter functions. Finally, the binary input offers a blocking function to enable or disable certain inputs.

4

Technical data	
Supply	
Voltage:	24 V DC (+6 V / -4 V)
Power consumption:	max. 225 mW
Connection:	KNX connection block
Input	
Number	6
Signal voltage	8 V ... 42 V AC/DC; 50/60 Hz
Signal current	approx. 4 mA at 24 V AC/DC per input
Signal length for pulse	T _{min.} = 200 ms at a mark-to-space ratio of 1:1
"0"-signal	0 ... 1.8 V AC 42 V ... 1.8 V DC
"1"-signal	> 8 V AC/DC
Input line length	100 m max. (unshielded)
Connection:	clamp bar
Behaviour at voltage drop	
only bus voltage	no reaction
only mains	–
bus and mains	no reaction
Behaviour at voltage recovery	
only bus voltage	dependent on parameters
only mains	–
bus and mains	dependent on parameters
Protection:	IP 20
Operation temperature:	–5°C ... +45°C
Storage temperature:	–25°C ... +70°C
Mounting:	on DIN rail 35 x 7.5

Note:

- 24 V and 230 V potentials are to be led in separate cables.

5

Description of universal software application:

General

- Free assignment of the switching, dimming, blind/shutter, valuator functions to the inputs.
- Free assignment of the pulse counter and switching counter functions to inputs 1 and 2.
For the pulse counter function parameterised for input 1 (2), input 3 (4) will be reserved for the sync signal and, therefore, cannot be used for any other functions.
- Signal indication is possible through four yellow status LED's. The status LED will light up when a signal is being applied and cannot be parameterised.
- Blocking object to enable / disable individual inputs.
- Delay times upon bus voltage recovery and debouncing time centrally adjustable.
- Behaviour on bus voltage recovery adjustable.
- Limit value for telegrams adjustable in general, for all inputs.

Switching function

- Two independent switching objects are available for each input and can be valued individually.
- Command upon rising and falling edges separately selectable (ON, OFF, TOGGLE, no response).
- Independent cyclic sending of the switching objects selectable as a function of the edge or of the object value, respectively.

Dimming function

- Single-level or two-level operation possible.
- Time between dimming and switching and dimming step width adjustable.
- Repetition of telegram and sending stop telegram possible.

Blind/shutter function

- Command upon the rising edge (no function, UP, DOWN, TOGGLE) adjustable.
- Operating concept parameterisable (short – long – short or long - short).
- Time between short-time mode and long-time mode adjustable (for short – long – short only).
- Louvres adjustment time (for louvers adjustment by one single push button action).

Transmitter and light scene extension function

- Edge (push button as normally-open contact, push button as normally-closed contact, switch) and a certain value can be parameterised.
- Value changing possible in case of push button mode by pressing push button for a longer time period.
- For light scene extension with memory function, saving of light scene is also possible without previously recalling it.

Temperature / brightness valuator functions

- Edge (push-button as normally-open contact, push-button as normally-closed contact, switch) and a certain value can be parameterised.
- Value changing possible in case of push-button mode by pressing push-button for a longer time period.

Pulse counter function

- Pulse counting edge and meter reading interval time can be parameterised.
- Sync signal edge for counter reset and corresponding switch telegram (including edge evaluation) adjustable.

Switching counter function

- Edge for counting of the input signals and maximum meter reading are adjustable.
- Step width for meter reading output and command (no telegram, ON, OFF, TOGGLE) upon reaching max. meter reading can be parameterised.

5 Objects for 2114 REG:

Number of addresses:	26
Number of assignments:	27
Communication objects:	12

Object	Name	Function	Type	Flag
Function: Switching (for all inputs)				
0 – 3	Input 1 – 4	Switching	1 Bit	C, W, T, (R)
Function: Dimming (for all inputs)				
0 – 3	Input 1 – 4	Switching	1 Bit	C, W, T, (R)
8 – 11	Input 1 – 4	Dimming	4 Bit	C, T, (R)
Function: Blind/shutter control (for all inputs)				
0 – 3	Input 1 – 4	Short time operation	1 Bit	C, T, (R)
8 – 11	Input 1 – 4	Long time operation	1 Bit	C, T, (R)
Function: Dimming value transmitter (for all inputs)				
0 – 3	Input 1 – 4	Value	1 Byte	C, T, (R)
Function: Light scene extension (for all inputs)				
0 – 3	Input 1 – 4	Light scene extension	1 Byte	C, T, (R)
Function: Temperature value transmitter (for all inputs)				
8 – 11	Input 1 – 4	Temperature value	2 Byte	C, T, (R)
Function: value transmitter (for all inputs)				
8 – 11	Input 1 – 4	Brightness value	2 Byte	C, T, (R)
Function: Impulse counter (for inputs 1 and 2 only)				
2	Input 3	Synch signal counter 1	1 Bit	C, W, T, (R)
3	Input 4	Synch signal counter 2	1 Bit	C, W, T, (R)
8	Input 1	Meter reading counter 1	2 Byte	C, T, (R)
9	Input 2	Meter reading counter 2	2 Byte	C, T, (R)
Function: Switching counter (for inputs 1 and 2 only)				
0	Input 1	Switching counter	1 Bit	C, W, T, (R)
1	Input 2	Switching counter	1 Bit	C, W, T, (R)
8	Input 1	Switching counter	2 Byte	C, T, (R)
9	Input 2	Switching counter	2 Byte	C, T, (R)
Function: Blocking (for all inputs)				
16 – 19 (*)	Input 1 – 4	Blocking	1 Bit	C, T, (R)

Objects marked with (R): Object value can be read out (set R-flag!)

Objects marked with (*): If the inputs have been parameterised to "no function", "impulse counter" or "switching counter", the blocking function is not active.

5 Objects for 2118 REG:

Number of addresses:	26
Number of assignments:	27
Communication objects:	24

Object	Name	Function	Type	Flag
Function: Switching (for all inputs)				
0 – 7	Input 1 – 8	Switching	1 Bit	C, W, T, (R)
Function: Dimming (for all inputs)				
0 – 7	Input 1 – 8	Switching	1 Bit	C, W, T, (R)
8 – 15	Input 1 – 8	Dimming	4 Bit	C, T, (R)
Function: Blind/shutter control (for all inputs)				
0 – 7	Input 1 – 8	Short time operation	1 Bit	C, T, (R)
8 – 15	Input 1 – 8	Long time operation	1 Bit	C, T, (R)
Function: Dimming value transmitter (for all inputs)				
0 – 7	Input 1 – 8	Value	1 Byte	C, T, (R)
Function: Light scene extension (for all inputs)				
0 – 7	Input 1 – 8	Light scene extension	1 Byte	C, T, (R)
Function: Temperature value transmitter (for all inputs)				
8 – 15	Input 1 – 8	Temperature value	2 Byte	C, T, (R)
Function: value transmitter (for all inputs)				
8 – 15	Input 1 – 8	Brightness value	2 Byte	C, T, (R)
Function: Impulse counter (for inputs 1 and 2 only)				
2	Input 3	Synch signal counter 1	1 Bit	C, W, T, (R)
3	Input 4	Synch signal counter 2	1 Bit	C, W, T, (R)
8	Input 1	Meter reading counter 1	2 Byte	C, T, (R)
9	Input 2	Meter reading counter 2	2 Byte	C, T, (R)
Function: Switching counter (for inputs 1 and 2 only)				
0	Input 1	Switching counter	1 Bit	C, W, T, (R)
1	Input 2	Switching counter	1 Bit	C, W, T, (R)
8	Input 1	Switching counter	2 Byte	C, T, (R)
9	Input 2	Switching counter	2 Byte	C, T, (R)
Function: Blocking (for all inputs)				
16 – 23 (*)	Input 1 – 8	Blocking	1 Bit	C, T, (R)

Objects marked with (R): Object value can be read out (set R-flag!)

Objects marked with (*): If the inputs have been parameterised to "no function", "impulse counter" or "switching counter", the blocking function is not active.

5 Objects for 2126 REG:

Number of addresses:	26
Number of assignments:	27
Communication objects:	18

Object	Name	Function	Type	Flag
Function: Switching (for all inputs)				
0 – 5	Input 1 – 6	Switching	1 Bit	C, W, T, (R)
Function: Dimming (for all inputs)				
0 – 5	Input 1 – 6	Switching	1 Bit	C, W, T, (R)
8 – 13	Input 1 – 6	Dimming	4 Bit	C, T, (R)
Function: Blind/shutter control (for all inputs)				
0 – 5	Input 1 – 6	Short time operation	1 Bit	C, T, (R)
8 – 13	Input 1 – 6	Long time operation	1 Bit	C, T, (R)
Function: Dimming value transmitter (for all inputs)				
0 – 5	Input 1 – 6	Value	1 Byte	C, T, (R)
Function: Light scene extension (for all inputs)				
0 – 5	Input 1 – 6	Light scene extension	1 Byte	C, T, (R)
Function: Temperature value transmitter (for all inputs)				
8 – 13	Input 1 – 6	Temperature value	2 Byte	C, T, (R)
Function: value transmitter (for all inputs)				
8 – 13	Input 1 – 6	Brightness value	2 Byte	C, T, (R)
Function: Impulse counter (for inputs 1 and 2 only)				
2	Input 3	Synch signal counter 1	1 Bit	C, W, T, (R)
3	Input 4	Synch signal counter 2	1 Bit	C, W, T, (R)
8	Input 1	Meter reading counter 1	2 Byte	C, T, (R)
9	Input 2	Meter reading counter 2	2 Byte	C, T, (R)
Function: Switching counter (for inputs 1 and 2 only)				
0	Input 1	Switching counter	1 Bit	C, W, T, (R)
1	Input 2	Switching counter	1 Bit	C, W, T, (R)
8	Input 1	Switching counter	2 Byte	C, T, (R)
9	Input 2	Switching counter	2 Byte	C, T, (R)
Function: Blocking (for all inputs)				
16 – 21 (*)	Input 1 – 6	Blocking	1 Bit	C, T, (R)

Objects marked with (R): Object value can be read out (set R-flag!)

Objects marked with (*): If the inputs have been parameterised to "no function", "impulse counter" or "switching counter", the blocking function is not active.

5 Notes to software application:

• Impulse counter

The pulse counters can only be parameterised to input 1 or 2. In this case, inputs 3 (for pulse counter 1) or 4 (for pulse counter 2) are the sync signal inputs and cannot be assigned to any other function. Pulse counters 1 and 2 run independently of each other and have a resolution of 16 bit so that counts between 0 and 65535 are possible. You can set the R-flag to read out the current count at object 8 or 9.

The counting pulse is applied to input 1 or 2. After the interval time specified as parameter has elapsed, the count will be taken over and sent as object value of the 2 byte "count" object (object 8 or 9). Then the 2 byte pulse counter will be internally reset during the next time interval. Only upon the appearance of a new edge at the input, or after the newly started interval time has elapsed, the current count can be read out from the count objects (set R-flag).

In addition, the count and the interval time can be reset by a sync signal applied to input 3 or 4, respectively. Moreover, switch telegrams (no telegram, ON, OFF, TOGGLE) can be sent in dependence of the sync signal edge. The output value can be assigned to the edge. The edge assignment for resetting the count can be parameterised independently of the output value.

For pulse counting, the mark-to-space time of a signal applied to input 1 or 2 must not fall below 100 ms.

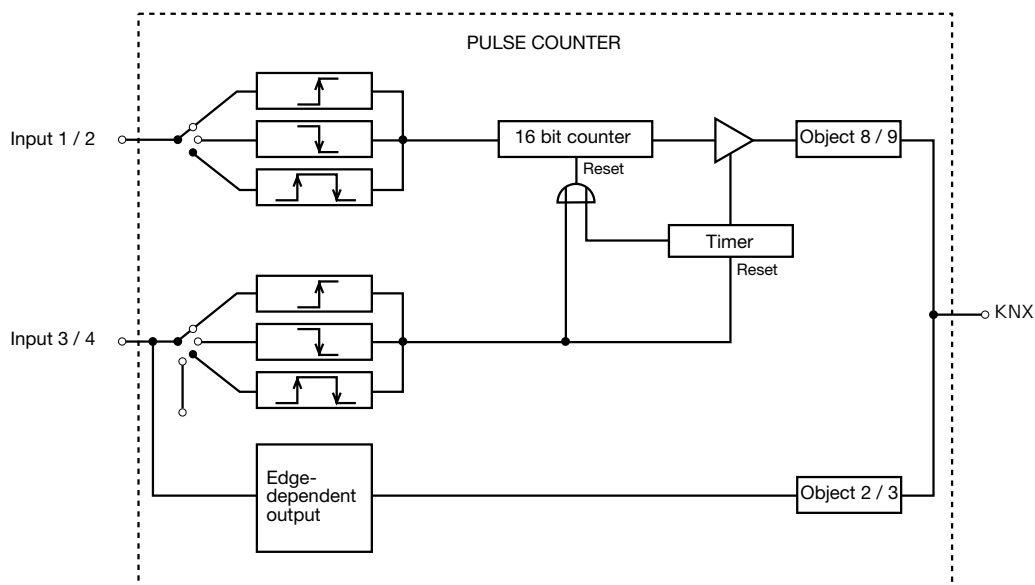

• Switching counter

The switching counters can only be parameterised to input 1 or 2. Switching counters 1 and 2 run independently of each other and have a resolution of 16 bit so that counts between 1 and 65535 are possible. You can set the R-flag to read out the current count at object 8 or 9.

The counting pulse is applied to input 1 or 2. After the count has reached the parameterised set value, it will be taken over into 2 byte object 8 or 9 and transmitted. Simultaneously, it is possible to output a signal value (1 bit object "0" or "1") which can be parameterised. After the transmission, the 16 bit counter will be automatically and internally reset. Only upon the appearance of a new edge at the input, the current count can be read out from the count objects (set R-flag).

Moreover, the count will be sent in cycles after a pre-defined number of counting pulses (1 ... 255), which is used to get an automatic update on any display for instance.

For switch counting, the mark-to-space time of a signal applied to input 1 or 2 must not fall below 100 ms.

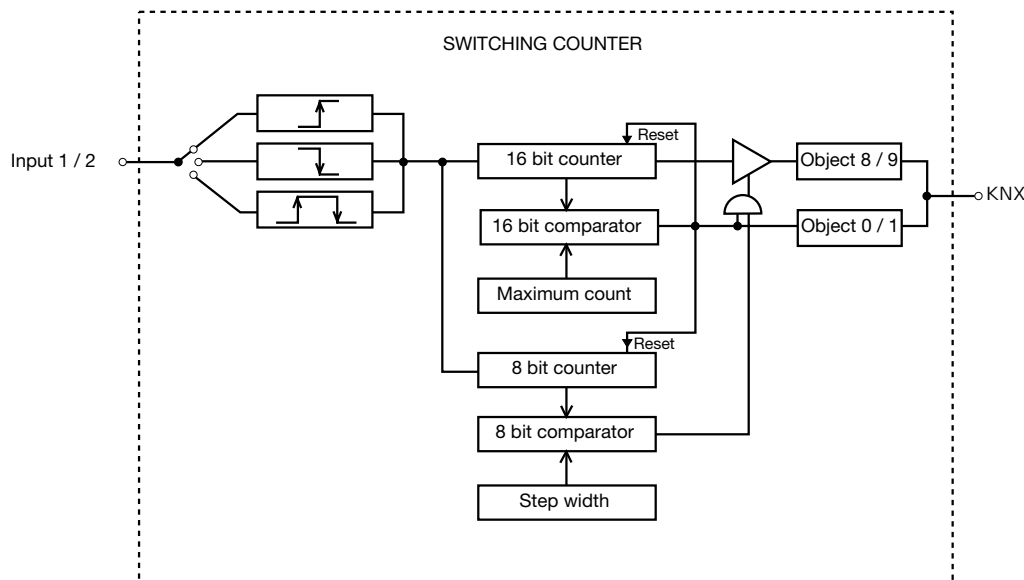

5 Notes to software application:

- Bus voltage recovery

You can specify for each input what response is to be made upon bus voltage recovery. If a delay time after bus voltage recovery has been parameterised, this time has to be elapsed until the response will be made. Within the delay, any edges or signals applied to the inputs will be ignored. The delay time should be parameterised for all inputs.

You can parameterise the limit number of telegrams. In such case, no telegram will be sent within the first 17 s after bus voltage recovery.

Please note that any possibly parameterised delay after bus voltage recovery may also be active during this time.

Any edge or signal applied to the inputs upon bus voltage recovery will be ignored.

- Blocking function

At the beginning or at the end of the blocking, an independent response can be made to each input. In this case, you can set the parameter to "no response". Only in such case, any dimming or blind/shutter control or value changing events running until the action is completed during an active blocking. In any other cases, the parameterised command will be sent immediately at the start of blocking. Moreover, any edges or signals at the corresponding inputs will not be accepted during an active blocking.

Updates on blocking objects (disable or enable) each time cause the corresponding parameterised command to be sent "at start or end of the blocking".

During an active blocking, there will be no cyclic sending through the disabled input.

If cyclic sending was taking place prior to an activation of the blocking function, no more cyclic sending will be performed at the end of the blocking, provided that "no telegram" has been parameterised. In this case, the cyclic transmission of the object value will only be effected again after an update on the switching object. In any other cases, the object value will be sent in cycles again after the end of blocking.

Analog Input

4-gang

1



2

	Ref.-No.
KNX analog input	2214 REGA
ETS-product family:	Input
Product type:	4-gang analog input
Series embodiment (SE)-device (4 units)	

3

The analog input processes measured-value data supplied by analog sensors. Four analog transducers in any combination can be connected to the input. The analog input evaluates voltage and current signals.

Voltage signals:	0 ... 1 V DC	0 ... 10 V DC
Current signals:	0 ... 20 mA DC	4 ... 20 mA DC

The 4 ... 20 mA current inputs can be monitored for open-circuit conditions.

The following sensors from the JUNG range can be connected to the analog input:

Brightness (WS 10 H), Twilight (WS 10 D), Temperature (WS 10 T), Wind (WS 10 W) and Rain (WS 10 R).

An optional analog input extension module, ref.-no. 2214 REGAM, connected by a 6-pole system connector adds four more analog sensor inputs to the device. A 6-pole connector can be used for future extensions.

The measured values are encoded by the analog input in the form of value telegrams (DPT 9.0xx, 2 byte or DPT 5.001, 1 byte) so that other bus subscribers (e.g. visualization software, Info Display) can display these measured values, generate messages or intervene in automatic control processes.

Each measured value has two presettable limit values. As soon as a measured value rises above or drops below these limits, the analog input can transmit the corresponding messages. The limit values can also be modified in operation by other devices as, for instance, a push-button sensor serving as a value transmitter.

The analog input needs 24 V AC for operation. This voltage can be supplied, for instance, by the power supply unit (WSSV 10). This power supply unit can at the same time also supply the power for wind sensor heating or the power for a connected analog input extension module.

The terminals U_s and GND supply 24 V DC (max. 100 mA altogether) to external analog sensors. In the event of short-circuits or overload between U_s and GND, the power is shut off.

3	Layout:	<p>Dimensions:</p> <p>Width: 72 mm (4 units)</p> <p>Height: 90 mm</p> <p>Depth: 58 mm</p>	<p>Controls:</p> <p>A: Programming button</p> <p>B: Programming LED</p> <p>C: Status LED, three-colour (red, orange, green)</p>																
		<p>Status LED functions:</p> <table border="0"> <tr> <td>LED off</td> <td>no power supply</td> </tr> <tr> <td>LED orange/on</td> <td>modul scan by analog input</td> </tr> <tr> <td>LED orange/flashing fast</td> <td>parameterization of analog extension module</td> </tr> <tr> <td>LED red/flashing slowly</td> <td>fault: low voltage at module connection / U_s short-circuited</td> </tr> <tr> <td>LED red/flashing fast</td> <td>fault: no project, parameterization error</td> </tr> <tr> <td>LED green/flashing slowly</td> <td>module scan terminated, projecting OK</td> </tr> <tr> <td>LED green/flashing fast</td> <td>parameter download into modules</td> </tr> <tr> <td>LED green/on</td> <td>parameter download to modules</td> </tr> <tr> <td></td> <td>initialization process terminated, everything OK</td> </tr> </table> <p>slow flashing: approx. 1 Hz</p> <p>fast flashing: approx. 2 Hz</p>	LED off	no power supply	LED orange/on	modul scan by analog input	LED orange/flashing fast	parameterization of analog extension module	LED red/flashing slowly	fault: low voltage at module connection / U_s short-circuited	LED red/flashing fast	fault: no project, parameterization error	LED green/flashing slowly	module scan terminated, projecting OK	LED green/flashing fast	parameter download into modules	LED green/on	parameter download to modules	
LED off	no power supply																		
LED orange/on	modul scan by analog input																		
LED orange/flashing fast	parameterization of analog extension module																		
LED red/flashing slowly	fault: low voltage at module connection / U_s short-circuited																		
LED red/flashing fast	fault: no project, parameterization error																		
LED green/flashing slowly	module scan terminated, projecting OK																		
LED green/flashing fast	parameter download into modules																		
LED green/on	parameter download to modules																		
	initialization process terminated, everything OK																		

4 Technical data

KNX Supply	
Voltage:	21 – 32 V DC (SELV)
Power consumption:	typically 150 mW
Connection:	Bus terminal (KNX Typ 5.1)
External supply, voltage:	24 V AC \pm 10 %
Current consumption:	250 mA max.
Power consumption:	max. 4 VA
Connection:	Screw terminals: 0.5 mm ² to 4 mm ² , single-wire 0.34 mm ² to 4 mm ² , fine-wire (without ferrule) 0.14 mm ² to 2.5 mm ² , fine wire (incl. ferrule)
Response to voltage failure	
Bus voltage only:	No communication with KNX.
Operating voltage only:	No communication with KNX, no feeding of the measuring sensors.
Bus and mains/operating voltage:	No communication with KNX, no feeding of the measuring sensors.
Response to recovery	
Bus voltage only:	No communication with KNX, no feeding of the measuring sensors.
Operating voltage only:	No communication with KNX.
Bus and mains/operating voltage:	Communication with KNX according to initialization parameters.
Module connection	
Numbers:	1
Connection:	6-pole system connector for analog input extension module
Analog inputs	
Number:	4
Signal voltage/current:	0 ... 1 V DC, 0 ... 10 V DC, 0 ... 20 mA DC or 4 ... 20 mA DC, depending on parameterization
Input resistance:	Voltage measurement: approx. 18 k Ω Current measurement: approx. 100 Ω
Connection:	Screw terminals: 0.5 mm ² to 4 mm ² , single-wire 0.34 mm ² to 4 mm ² , fine-wire (without ferrule) 0.14 mm ² to 2.5 mm ² , fine-wire (incl. ferrule)
Measuring sensor power supply outputs	
Number:	2
Rated voltage:	24 V DC \pm 10 %
Rated current:	100 mA DC (total)
Connection:	Screw terminals: 0.5 mm ² to 4 mm ² , single-wire 0.34 mm ² to 4 mm ² , fine-wire (without ferrule) 0.14 mm ² to 2.5 mm ² , fine-wire (incl. ferrule)
Protection:	IP 20
Safety class:	III
Mark of approval:	KNX/VDE
Ambient temperature:	-5°C ... +45°C
Storage/transport temperature:	-25°C ... +70°C (storage above +45°C reduces the lifetime)
Mounting position:	any
Minimum distances:	none
Fastening:	on DIN rail 35 x 7.5

4 Wiring diagram for connection of an analog input module

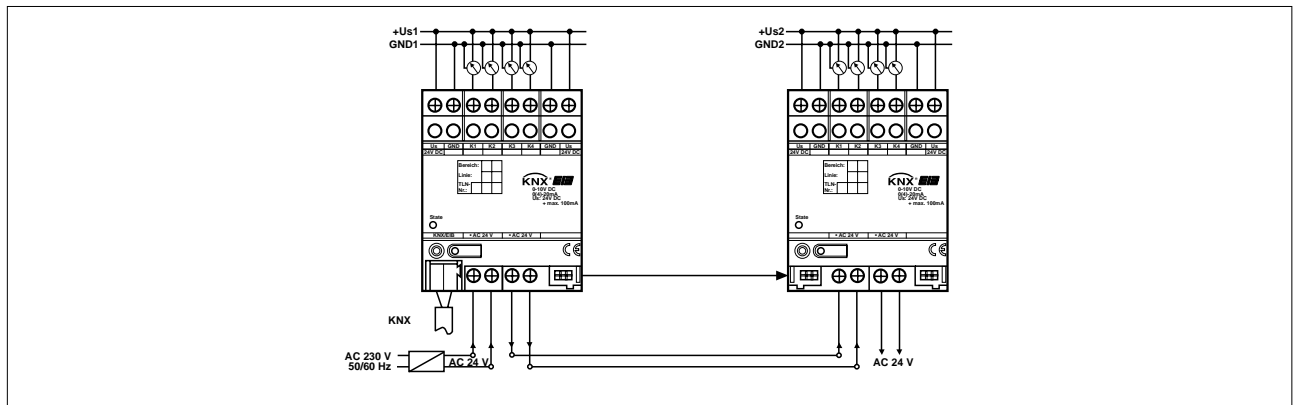

Remarks on the hardware

Please observe the following basic rules when installing the analog input station:

- Any sensors connected can be power-supplied via terminals $+U_s$ and GND (refer to the wiring diagram). These terminals are provided in duplicate and are internally connected with each other. The total current consumption of all sensors power-supplied this way must not exceed 100 mA.
- In the event of a short-circuit between $+U_s$ and GND, the voltage will be switched off. After the elimination of the fault, the voltage will reappear automatically.
- Sensors connected can also be power-supplied externally (SELV), e.g. if their current consumption exceeds 100 mA. In this case, such sensors must be connected between terminals K1 ... K4 and GND.
- The $+U_s$ and GND terminals must not be connected with the corresponding inputs of a different device. The power supply of any sensors used through an analog input module connected is not permitted (hazard of destruction).

Please observe the following basic rules when installing the analog input extension module:

- The analog input extension module is connected to the analog input only with the 6-pole system connector (supplied with the analog input extension module). Only one analog input extension module can be connected to the device.
- The analog input and the analog input extension module can be connected to the same 24 V AC power supply. The connecting terminals are double terminals for easy wiring. Corresponding terminals are marked with dots.
- The $+U_s$ and GND terminals of the analog input extension module must not be connected to the corresponding terminals of another device, e.g. of the analog input, to prevent problems caused by ground loops.
- Sensors connected to the inputs of the analog input extension module must not get their power supply from the analog input. Sensors connected to the inputs of the analog input must not get their power supply from the analog input extension module.
- If defective, an analog input extension module can be replaced by one of the same type while the system is in operation (disconnect voltage supply from module!). After the replacement, the analog input makes a reset after abt. 25 s. This action re-initializes all inputs and outputs of the analog input / analog sensor interface and of the module connected and resets them to their original state.
- Removal or addition of modules without adapting the project and subsequent downloading into the analog input is not permitted as this will result in system malfunctioning.
- After first activation, the analog input performs a module scan (status LED: "Orange / On"). As a new device is not projected from the start, the status LED thereafter switches to "Red / Flashing fast".
- A connected analog input extension module signals its ready-for-operation status by switching its status LED to "Flashing fast".
- After loading a project into the analog input, the status LED switches to "Green / On"; and the module switches its status LED off.

4 Scope of functions:

- Up to four analog sensors with output signals of 0 ... 1 V DC, 0 ... 10 V DC, 0 ... 20 mA DC, 4 ... 20 mA DC can be connected directly to the analog input.
- The connecting lines of the sensors with 4 ... 20 mA outputs can be monitored for open-circuit conditions.
- An analog input extension module permits the connection of up to four more analog sensors.
- The values measured by the analog sensors can be transmitted in the form of 16-bit or 8-bit values.
- The measuring values can be transmitted after value changes and/or cyclically.
- For analog sensors, two limit values with definable hysteresis characteristics can be used.
- The limit values can be modified with external devices as 8-bit values or as 16-bit values.

Analog Input Weather Station

1



2

	Ref.-No.
KNX weather station	2224 REG W
ETS-product family:	Input
Product type:	4-gang analog input
Series embodiment (SE)-device (4 units)	

3

The weather station serves to collect and forward weather data and events. A digital combination sensor (to measure the wind intensity, brightness and twilight as well as rain; with or without DCF77 receiver), and up to four analog measuring sensors can be connected to the weather station. An optional analog input extension module, allows the extension of the range of analog measuring sensors to be connected by another four.

The following measuring sensors, for which preset parameters are available in the device software, can be connected to the analog inputs: Brightness (WS 10 H), Twilight (WS 10 D), Temperature (WS 10 T), Wind (WS 10 W) and Rain (WS 10 R).

Alternatively, other measuring sensors supplying voltage or current signals (0 ... 1 V DC, 0 ... 10 V DC, 0 ... 20 mA DC, 4 ... 20 mA DC) can be used, too. For sensors which supply 4 ... 20 mA signals, the device software parameters offer the option to select wire breakage or open-circuit monitoring.

The values measured are translated by the weather station into value telegrams (DPT 9.0xx, 2-byte or DPT 5.001, 1-byte type). Thus, other bus devices (e.g. visualization software, info display) can display such measured values, generate messages or control weather-dependent processes.

For each measured value, two adjustable limits are available. Once a measured value exceeds or falls below such limits, the weather station can issue corresponding messages. At the same time, such limits can be gated. Cascading several weather stations can even help to implement complex functions. The weather station needs an operating voltage supply of 24 V AC. The latter can, for example, be provided by a power supply module (WSSV 10). At the same time such power supply module can also heat wind sensors or feed an analog input module connected. Terminals +U_s and GND serve to supply external analog sensors with 24 V DC (100 mA max. in total). In the event of a short-circuit between +U_s and GND, the voltage will be switched off.

3 Layout:

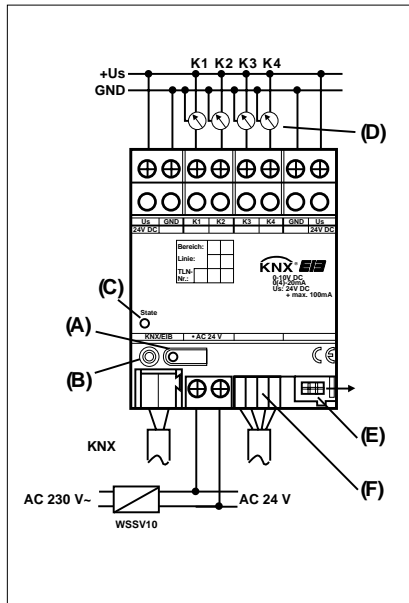

Dimensions:
 Width: 72 mm (4 units)
 Height: 90 mm
 Depth: 58 mm

Controls:
 A: Programming key
 B: Programming LED
 C: Status LED, three-colour (red, orange, green)
 D: Measuring sensors
 E: Module connector, 6-pole
 F: Combi sensor connector, 4-pole

Status LED functions:

LED off	no power supply
LED orange/on	modul scan by weather station
LED orange/flashing slowly	combi sensor module scan (waiting for assignment)
LED orange/flashing fast	DIN rail extension module (REG) parameterization
LED red/flashing slowly	fault: undervoltage at module connection / U_s short-circuited
LED red/flashing fast	fault: no project, parameterization error
LED green/flashing slowly	module scan complete, projecting OK
LED green/flashing fast	parameter download into modules
LED green/on	parameter download to modules
	initialization process terminated, everything OK
slow flashing:	approx. 1 Hz
fast flashing:	approx. 2 Hz

4 Technical data

KNX Supply

Voltage: 21 – 32 V DC (SELV)
 Power consumption: typically 150 mW
 Connection: Bus terminal (KNX Typ 5.1)
 External supply, voltage: 24 V AC \pm 10 %
 Current consumption: 250 mA max.
 Power consumption: max. 4 VA
 Connection: Screw terminals:

0.5 mm² to 4 mm², single-wire
 0.34 mm² to 4 mm², fine-wire (without ferrule)
 0.14 mm² to 2.5 mm², fine-wire (incl. ferrule)
 Stud torque max. 0.8 nM

Response to voltage failure

Bus voltage only: No communication with KNX.
 Operating voltage only: No communication with KNX, no feeding of the measuring sensors.
 Bus and mains/operating voltage: No communication with KNX, no feeding of the measuring sensors.

Response to recovery

Bus voltage only: No communication with KNX, no feeding of the measuring sensors.
 Operating voltage only: No communication with KNX.
 Bus and mains/operating voltage: Communication with KNX according to initialization parameters.

Module connection

Number: 2
 Connection: 6-pole system connector for analog input extension module
 4-pole system connector for combi sensor

Analog inputs

Number: 4
 Signal voltage/current: 0 ... 1 V DC, 0 ... 10 V DC, 0 ... 20 mA DC or 4 ... 20 mA DC, depending on parameterization

Input resistance:

Voltage measurement: approx. 18 k Ω
 Current measurement: approx. 100 Ω

Connection:

Screw terminals: 0.5 mm² to 4 mm², single-wire
 0.34 mm² to 4 mm², fine-wire (without ferrule)
 0.14 mm² to 2.5 mm², fine-wire (incl. ferrule)

Protection:

IP 20

Safety class:

III

Mark of approval:

KNX/VE

Ambient temperature:

-5°C ... +45°C

Storage/transport temperature:

-25°C ... +70°C (storage above +45°C reduces the lifetime)

Mounting position:

any

Minimum distances:

none

Fastening:

on DIN rail 35 x 7.5

4 Technical data

Measuring sensor power supply outputs

Number:	2	
Rated voltage:	24 V DC $\pm 10\%$	
Rated current:	100 mA DC (total)	
Connection:	Screw terminals:	0.5 mm ² to 4 mm ² , single-wire 0.34 mm ² to 4 mm ² , fine-wire (without ferrule) 0.14 mm ² to 2.5 mm ² , fine-wire (incl. ferrule)

Wiring diagram with extension module and combi sensor

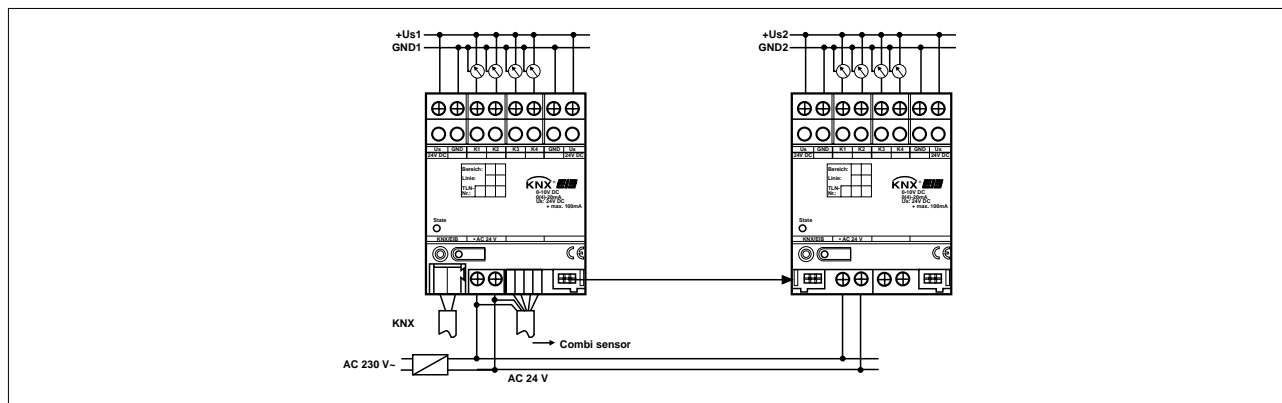

Remarks on the Hardware

Please observe the following basic rules when installing the weather station:

- Any sensors connected can be power-supplied via terminals +U_s and GND (refer to the wiring diagram). These terminals are provided in duplicate and are internally connected with each other. The total current consumption of all sensors power-supplied this way must not exceed 100 mA.
- In the event of a short-circuit between +U_s and GND, the voltage will be switched off. After the elimination of the fault, the voltage will reappear automatically.
- Sensors connected can also be power-supplied externally (SELV), e.g. if their current consumption exceeds 100 mA. In this case, such sensors must be connected between terminals K1 ... K4 and GND.
- The pillar terminal block for the connection of the combination sensor must be plugged on before the mains voltage is switched on and during operation to prevent the digital input from unintentional contact with live wiring. The device as well as any sensors or analog input extension modules connected can be destroyed thereby.
- The +U_s and GND terminals must not be connected with the corresponding inputs of a different device. The power supply of any sensors used through an analog input extension module connected is not permitted (hazard of destruction).

Please observe the following basic rules when installing the combi sensor:

- The sensor comes with a stainless steel bracket for installation on a tubular pole (35 ... 50 mm dia.). Depending on the wind intensity, very high forces can occur on such pole.
- If external lightning protection is provided the pole must not be higher than the lightning rod.
- The combi sensor should not be affected from any direction by obstacles or shadows. For this reason, a sufficient distance from walls or roof superstructures such as exhaust blowers should be kept.
- To enable the brightness and the twilight sensors to clearly detect the solar altitude align the combi sensor so that its precipitation window faces north.
- Removing or adding modules without adapting their configuration and subsequent downloading into the weather station is not allowed as this will result in system malfunctioning.
- After the first start, the weather station will run a module scan (status LED: "orange/ON"). Since a new device does not include any configuration by default the status LED will then change to "red/quickly blinking".
- The combi sensor connected indicates its readiness for operation by two short tones which will recur every 5 s.
- In this state, the combi sensor can be logged in and the antenna aligned (refer to the combi sensor operating instructions).
- A defective combi sensor can be replaced in operation by another one of the same type. In such case, the new combi sensor must be logged in once again and aligned. After logging in the new combi sensor, the weather station will reset after about 25 s. This will re-initialize all inputs and outputs of the weather station and of the modules connected and reset them to their original state.

4 Remarks on the hardware

Please observe the following basic rules when installing the analog input extension module:

- One analog input extension module at maximum can be connected to the weather station.
- Always use the 6-pole system connector (comes with the analog input extension module) to connect the analog input extension module to the weather station.
- A defective analog input extension module can be replaced in operation by another one of the same type (disconnect the module from the voltage supply). After replacement, the weather station will reset after about 25 s. This will re-initialize all inputs and outputs of the weather station and of the modules connected and reset them to their original state.
- Removing or adding any modules without adapting their configuration and subsequent downloading into the weather station is not allowed as this will result in system malfunctioning.
- After the first start, the weather station will run a module scan (status LED: "orange/ON"). Since a new device does not include any configuration by default the status LED will then change to "red/quickly blinking".
- An analog extension input module indicates its readiness for operation by changing its status LED to "quickly blinking".
- After loading a project into the weather station, the status LED will change to "green/ON", with the module turning off its status LED.

5 Scope of functions:

- The weather station can be combined with a digital combi sensor to detect brightness (in triple form), twilight, wind speed and precipitation (rain) as well as for DCF77 reception.
- The connection to the combi sensor and the wind measured values of the combi sensor can be monitored.
- In conjunction with DCF77 reception, automatic shading of up to four façades with slat readjustment in dependence on the sun position can be implemented.
- Up to four analog sensors providing output signals of 0 ... 1 V DC, 0 ... 10 V DC, 0 ... 20 mA DC, 4 ... 20 mA DC can be directly connected to the weather station.
- The connections to sensors with 4 ... 20 mA outputs can be monitored for wire breakage (open circuit).
- With the aid of an analog input extension module, up to four additional analog sensors can be connected.
- For selected weather sensors (wind, brightness, twilight, precipitation (rain), temperature, air humidity, atmospheric pressure) pre-configured software settings are available.
- The measured values of the weather sensors (with the exception of the precipitation sensor) can be output in 16-bit form. Output can take place when values change or in cycles.
- The measured values of the analog sensors can be output in 16-bit or in 8-bit form. Output can take place when values change or in cycles.
- The precipitation (rain) sensor outputs are 1-bit values.
- For each of the analog sensors and for the weather sensors (with the exception of the precipitation sensor), two limit values with definable hystereses are available.
- These limit values can be externally preset as 8-bit or 16-bit values.
- Up to 16 blocking modules facilitate the filtering of 1-bit, 8-bit or 16-bit values.
- Up to 20 logic gates with up to eight inputs each can be used.
- AND, OR and exclusive OR can be selected as logic functions.
- The inputs and outputs of the logic gates can be inverted.

Automatic shading

Shading control with automatic readjustment of the shutter/blind slats offers the optimized utilization of the natural daylight, avoiding extreme dazzling at the same time.

The automatic shading control function is based on the calculated position of the sun which, for the human observer, moves from east over south to west during the course of the day. In this connection, the path of the sun is very flat in winter and very steep in summer.

Also, information on the building is required.

The shutter/blind actuators must facilitate slat positioning through a 1-byte communication object.

Calculating the sun position

The weather station calculates the position of the sun from the geographical position of the building as well as from the current time and the current date.

The geographical position can be entered within the framework of the configuration work. For this purpose, either the exact coordinates of the building are available, or a neighbouring town or city can be selected from the list. To get the correct time the weather station uses the DCF77 receiver of the combi sensor or the time from any timing device in the system, e.g. FP 701 CT etc. From these values, the weather station can calculate the correct sun position.

Steep path of the sun in summer

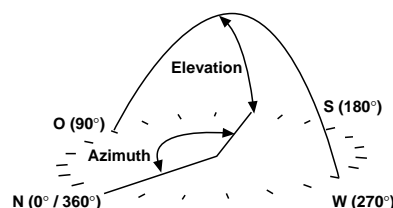

From the viewpoint of the observer, the sun's position is described by two angles. The azimuth defines the angle between the geographical north direction and a vertical circle through the centre of the sun. The elevation (sun height) defines the angle between the horizon and the sun's centre.

5 Building orientation

The automatic shading control starts at the moment when at least one of the three brightness sensors indicates that the luminance has exceeded the selectable threshold.

To enable the weather station to determine for which of the up to four facades of the building shading is necessary the orientation and the opening angle are still required for each facade.

Example:

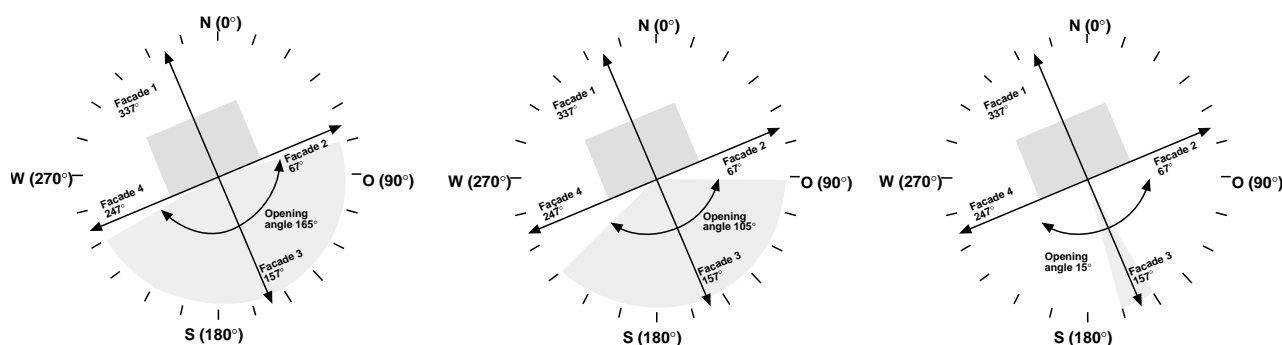

The orientation of the facade is determined by the direction of a vertical line projected onto each facade. Such orientation data can, for example, be obtained from the construction documents.

The opening angle determines in what range the sun azimuth must be so that disturbing dazzling can occur. Entering a value of 180° means, that as soon as the sun just begins to shine through the windows of this facade, the shutters/blinds of this facade will be moved down. If an opening angle of 1° has been entered, the azimuth must virtually be vertical to the facade. It is possible either to set a fixed opening angle, or to vary it in operation by an external value transmitter. In such case, the external opening angle will overwrite the parameterised value.

Shutter/blind control

The weather station will send a 1-bit telegram with the value of "1" for each facade if the brightness threshold has been exceeded and the sun azimuth is within the opening angle of the facade. This "Facade shading" communication object will be linked up with the "Long-time operation" objects of the shutter/blind actuators for this facade.

Thus, the shutters/blinds of this facade can be moved down. To enable all shutter/blind drives to really reach their bottom end position the slats will be positioned only after some waiting time.

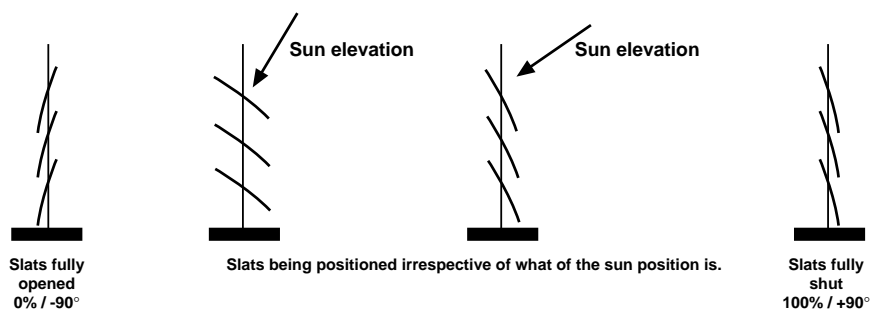

The positioning of the slats depends on the elevation of the sun. To obtain optimum protection from dazzling the slats must be adjusted vertically to the falling sunlight. For adaptation to different actuators, slat positioning can be effected either with percentage values or by angular data. In this connection, an offset can be selected for adaptation to different slat curtain materials.

As long as the sun radiation is above the parameterised "Basic brightness for shading" value, the slat positioning telegrams will be sent in cycles. For most of the shutters/blinds, slat readjustment is effected by short-time moving of the slat curtain. For this reason, the slat positioning cycle time should not be selected too short.

Analog Input Extension Module

1

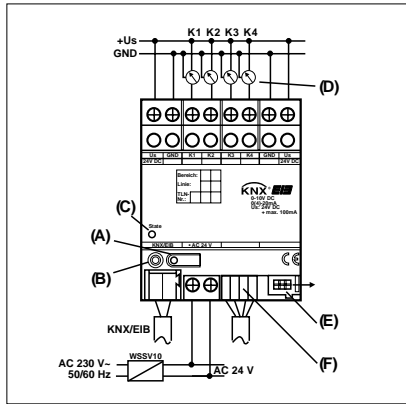

2

	Ref.-No.
Analog input extension module	2214 REGAM
(No KNX device)	
Series embodiment (SE)-device (4 units)	

3

The analog input extension module exceeds a KNX Weather station 2224 REG W or a KNX by four additional sensor inputs. The evaluation of the measured data and the limiting values will be handled by the connected KNX device.

The analog input extension module evaluates voltage and current signals.

Voltage signals:	0 ... 1 V DC	0 ... 10 V DC
Current signals:	0 ... 20 mA DC	4 ... 20 mA DC

The analog input extension module needs an external 24 V power supply, WSSV 10.

4

Technical data

Connection to KNX device:	6-pole system plug
Sensor input:	4 x analog
Signal voltage/current:	0 ... 1 V DC, 0 ... 10 V DC, 0 ... 20 mA DC or 4 ... 20 mA DC
Input resistance:	Voltage measurement: approx. 18 kΩ Current measurement: approx. 100 Ω
Supply of external sensors:	24 V DC, max. 100 mA
Protection:	IP 20
Safety class:	III
Supply voltage:	24 V AC ± 10 %
Current consumption:	max. 170 mA
Power consumption at system plug:	typ. 150 mW
Ambient temperature:	-5°C ... +45°C
Storage/transport temperature:	-25°C ... +70°C (storage above +45°C reduces the lifetime)
Connection:	Screw terminals: 0.5 mm ² to 4 mm ² , single-wire 0.34 mm ² to 4 mm ² , fine-wire (without ferrule) 0.14 mm ² to 2.5 mm ² , fine-wire (incl. ferrule)

Analog Input Power Supply

1

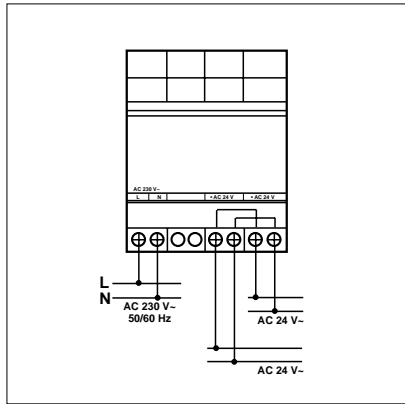

2

	Ref.-No.
Power supply	WSSV 10
(No KNX device)	
Series embodiment (SE)-device (4 units)	

3

The power supply AC 24 V serves for the supply of KNX devices as e.g. Weather station 2224 REG W, Analog input 2214 REG A or analog input extension module 2214 REG AM.

Above that, also the sensors as e.g. WS 10 W, WS 10 R or the Combi sensor WS 10 KS and their internal heating can be supplied as far as the max. output current of the power supply is not exceeded.

The power supply is protected against overload and short-circuits by a thermo-switch.
Automatic restart after cool down or elimination of the short circuit.

4

Technical data

Net voltage:	230 V AC \pm 10 %, 50/60 Hz
Output voltage:	24 V AC \pm 10 %, 50/60 Hz
Output current:	max. 1 A
Power-on time:	100 %
Short-circuit protection:	Thermo switch
Ambient temperature:	-5°C ... +40°C, ice free
Storage/transport temperature:	-25°C ... +70°C
Protection:	IP 20
Connection:	Screw terminals: 0.34 mm ² to 4 mm ² , fine-wire (without ferrule) 0.14 mm ² to 2.5 mm ² , fine-wire (incl. ferrule)

Combi sensor

1

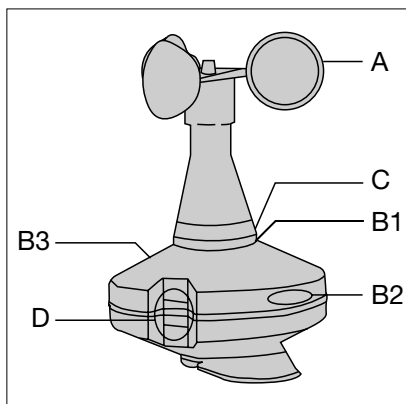

A: Wind wheel
 B1 ... B3: Brightness sensors
 west, east, south
 C: Dawn sensor
 D: Rain sensor

2

	Ref.-No.
Combi sensor	WS 10 KS
- with DCF77 receiver	WS 10 KSDCF
(No KNX device)	

3

The combi sensor serves for the measurement of the wind speed, brightness dawn and rain. The brightness can be measured for three directions, south, east and west, separately. The combi sensor will be connected directly to the weather station (2224 REG W) which evaluates the measured data and transmits these as switching or value telegrams to the bus.

The combi sensor WS 10 KSDCF includes an additional DCF77 receiver for the official German time signal. The combi sensor needs an external 24 V AC supply, e.g. power supply WSSV 10.

4

Technical data

Supply:	24 V AC \pm 15 %, 50/60 Hz
Max. current consumption:	600 mA
Power consumption:	max. 14.4 W (sensors and heating)
Ambient temperature:	-5°C ... +45°C
Connection cable:	LiYCY, 6 x 0.25 mm, 10 m, max. 50 m
Ambient temperature:	-40°C ... +60°C, ice free
Storage/transport temperature:	-40°C ... +60°C
Protection:	IP 55, in standard purpose acc. to DIN EN 60592
Safety class:	III
Dimensions:	130 x 200 mm (without mounting bracket)
Fastening:	mounting bracket for wall or mast

Sensor signals

Wind speed:	1 ... 40 m/s
Accuracy:	\leq 0.5 m/s, -20°C ... +60°C
Rain:	Yes / No
Sensitivity:	fine drizzle
Switch On delay:	approx. 3 rain particles
Switch Off delay:	approx. 2 minutes

Brightness

Range:	0 ... 110 KLux
Spectral range:	700 ... 1050 nm
Resolution:	10 bit
Direction:	east, south, west

Dawn

Range:	0 ... 674 Lux
Resolution:	10 bit

Analog Sensors for Weather Station

1

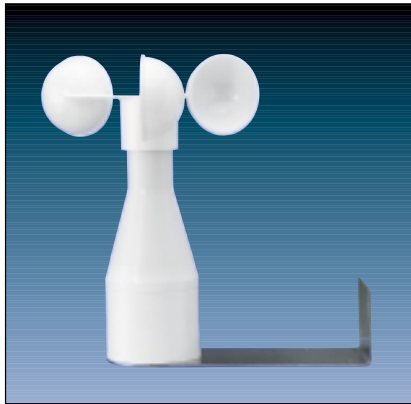

Connections:

brown	operating volt. + 24 V
white	correspond. ground
green	output 0 V / 10 V
yellow	correspond. ground
pink	heating 24 V
grey	heating 24 V

2

Wind sensor
(No KNX device)

Ref.-No.

WS 10 W

3

The wind sensor converts the wind speed into electrical signals. These signals are generated by a Reed contact which closes under the influence of magnets.

The generated impulses are transformed into an output voltage proportional to the wind speed.

A PTC-heating element takes care for a trouble free winter operation (only in combination with heating transformer WSSV 10).

4

Technical data

Range:	0,7 ... 40 m/s
Electrical output:	0 ... 10 V at 40 m/s
Supply voltage:	18 ... 32 V DC
Current consumption:	6 ... 12 mA
Contact type:	Reed contact
Heating:	PTC-element (800 C)
Operating voltage heating:	24 V AC/DC
Lead wire:	3 m (LIYY 6 x 0.25 mm ²)

Analog Sensors for Weather Station

1

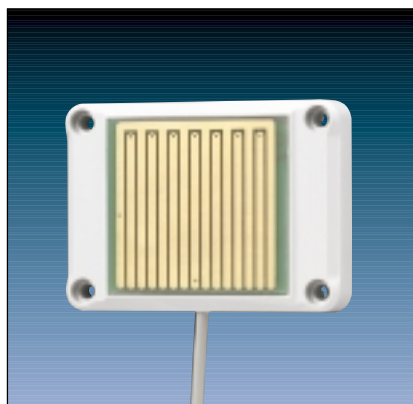

Connections:

brown	operating volt. + 24 V
white	correspond. ground
green	output 0 V / 10 V
yellow	heating 24 V
grey	heating 24 V

2

Rain sensor
(No KNX device)

Ref.-No.

WS 10 R

3

The rain sensor is used for the measuring and evaluation of the rainfall.
With a meander shaped sensor the conductance of the rain water is evaluated.
A micro processor controls the heating (only in combination with heating transformer WSSV 10) and offers an output signal of 0 V or 10 V.

4

Technical data

Range of the electrical output: 0 V dry / 10 V rain (min. 1 k Ω load)
Lead wire: 3 m (LIYY 5 x 0.25 mm²)

Plasting housing with sealed electronics



Connections:

- | | |
|---|------------------------|
| 1 | operating volt. + 24 V |
| 2 | correspond. ground |
| 3 | output 0 ... 10 V |

2

Brightness sensor
(No KNX device)

Ref.-No.
WS 10 H

3

The brightness sensor is used for the measuring and evaluation of the brightness.
The brightness measured by a photodiode is transmitted to an analog output signal of 0 V – 10 V by the electronics.

4

Technical data

Range:	0 ... 60.000 Lux, linear
Electrical output:	0 V ... 10 V, short-circuit / proof
Protection:	IP 65

Plasting housing

with PG7 thread + screw and pressure respectively moisture compensation (recommended cable 3 x 0.25 mm²)



Connections:

- | | |
|---|------------------------|
| 1 | operating volt. + 24 V |
| 2 | correspond. ground |
| 3 | output 0 ... 10 V |

2

Dawn sensor
(No KNX device)

Ref.-No.
WS 10 D

3

The dawn sensor is used for the measuring and evaluation of the brightness (dawn/dusk).
The brightness measured by a photodiode is transmitted to an analog output signal of 0 V – 10 V by the electronics.

4

Technical data

Range:	0 ... 255 Lux, linear
Electrical output:	0 V ... 10 V, short-circuit / proof
Protection:	IP 65

Plasting housing

with PG7 thread + screw and pressure respectively moisture compensation (recommended cable 3 x 0,25 mm²)

1



Connections:

- 1 operating volt. + 24 V
- 2 correspond. ground
- 3 output 0 ... 10 V

2

	Ref.-No.
Temperature sensor (No KNX device)	WS 10 T

3

The temperature sensor is used for the measuring and evaluation of the temperature.
The temperature measured by a temperature sensor is transmitted to an analog output signal of 0 V – 10 V by the electronics.

4

Technical data

Range: -30 °C ... +70 °C, linear
Electrical output: 0 V ... 10 V, short-circuit / proof
Protection: IP 65

Plasting housing

with PG7 thread + screw and pressure respectively moisture compensation (recommended cable 3 x 0.25 mm²)

Analog output

4-gang

1

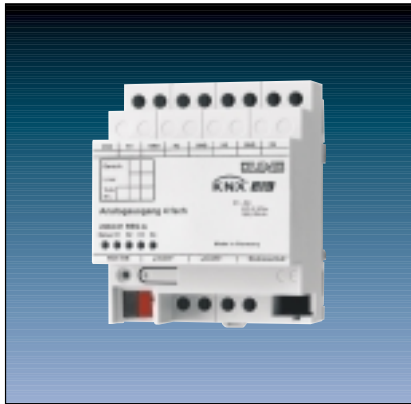

2

	Ref.-No.
KNX analog output	2204.01 REGA
ETS-product family:	Output
Product type:	4-gang analog output
Series embodiment (SE)-device (4 units)	

3

The analog output converts measuring data received via KNX telegrams (DPT-ID 9.0xx and 5.010) into analog output signals. The analog output signals enable heating, ventilation and air conditioning units to adapt their output values to information received from the bus and thus to take part in control processes.

Voltage signals:	0 ... 1 V DC	0 ... 10 V DC
Current signals:	0 ... 20 mA DC	4 ... 20 mA DC

The analog output offers four analog outputs which can be software-parameterised for one of the ranges mentioned above.

Outputs not used can be deactivated.

The output variables can be force-controlled from a coordinating control system.

With an analog output extension module, the number of analog outputs can be increased from 4 to 8.

In conjunction with the "dimming" function of a sensor, both, the analog output and also the analog output extension module can be used as an active control unit for dimming applications.

The analog output needs 24 V AC for operation. The necessary power can be supplied by the power supply unit (WSSV 10). This power supply unit is capable of supplying power at the same time to a connected analog output extension module.

3

Layout:

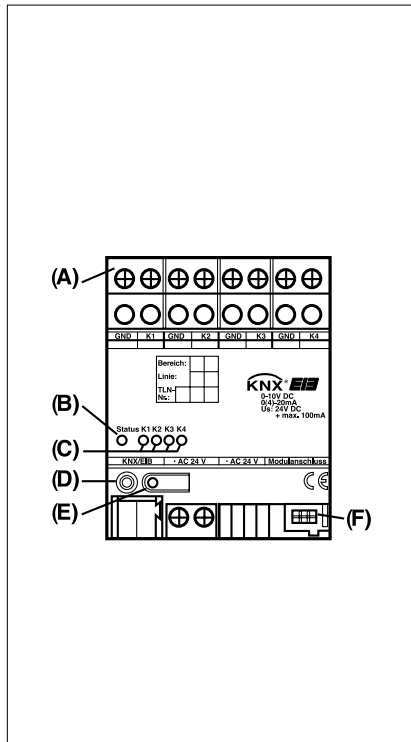

Dimensions:

Width: 4 mod, 72 mm
 Height: 90 mm
 Depth: 58 mm

Controls:

A: Analog outputs 1 ... 4
 B: Status LED of device, three-colour (red, orange, green)
 C: Status LED's of the four outputs mono, yellow
 D: Programming LED
 E: Programming button
 F: System connector, 6-pole, for analog output extension module

Status LED (B) indication for analog actuator:

LED off	no power supply
LED orange/on	modul scan by analog actuator
LED orange/flashing fast	module scan of analog output extension module
LED red/flashing slowly	fault: undervoltage at module connection / U _s short-circuited
LED red/flashing fast	fault: no project, parameterization error
LED green/flashing slowly	module scan complete, projecting OK
LED green/flashing fast	parameter download into modules
LED green/on	parameter download to modules initialization process terminated, everything OK

slow flashing: approx. 1 Hz
 fast flashing: approx. 2 Hz

Status LED (C) indication for the 4 analog outputs:

LED off	output signal is zero
LED on	output signal is greater than zero

4

Technical data

KNX Supply

Voltage:

21 – 32 V DC (SELV)

Power consumption:

typically 150 mW

Connection:

Bus terminal (KNX Typ 5.1)

External supply, voltage:

24 V AC ± 10 %

Connection:

Screw terminals: 0.5 mm² to 4 mm², single-wire
 0.34 mm² to 4 mm², fine-wire (without ferrule)
 0.14 mm² to 2.5 mm², fine-wire (incl. ferrule)
 Stud torque max. 0.8 nM

Response to voltage failure

Bus voltage only:

parameterizable: last value maintained; fixed value (in %)

Mains voltage only:

outputs down to 0 V or to 0 mA

Bus and mains voltage:

outputs down to 0 V or to 0 mA

Response to recovery

Bus voltage only:

parameterizable: no reaction; state of initialization; last value before failure

Mains voltage only:

parameterizable status request of group addresses, determination and setting

Bus and mains/operating voltage:

parameterizable status inquiry of group addresses, determination and setting

Protection:

IP 20

Safety class:

III

Mark of approval:

KNX/VDE

Ambient temperature:

-5°C ... +45°C

Storage/transport temperature:

-25°C ... +70°C (storage above +45°C reduces the lifetime)

Mounting position:

any

Minimum distances:

none

Fastening:

on DIN rail 35 x 7.5

4 Technical data

Module connection

Number:	1
Connection:	6-pole system connector for extension module
Analog outputs	
Number:	4
Type of signal:	0 ... 1 V DC, 0 ... 10 V DC, 0 ... 20 mA DC or 4 ... 20 mA DC, depending on parameterization
Output signal load:	voltage signal: $\geq 1 \text{ k}\Omega$ current signal: $\leq 500 \Omega$
Output current:	voltage signal: max. 10 mA per channel current signal: ma.x 20 mA pe channel
Connection:	Screw terminals: 0.5 mm ² to 4 mm ² , single-wire 0.34 mm ² to 4 mm ² , fine-wire (without ferrule) 0.14 mm ² to 2.5 mm ² , fine-wire (incl. ferrule)

Connection of an extension module

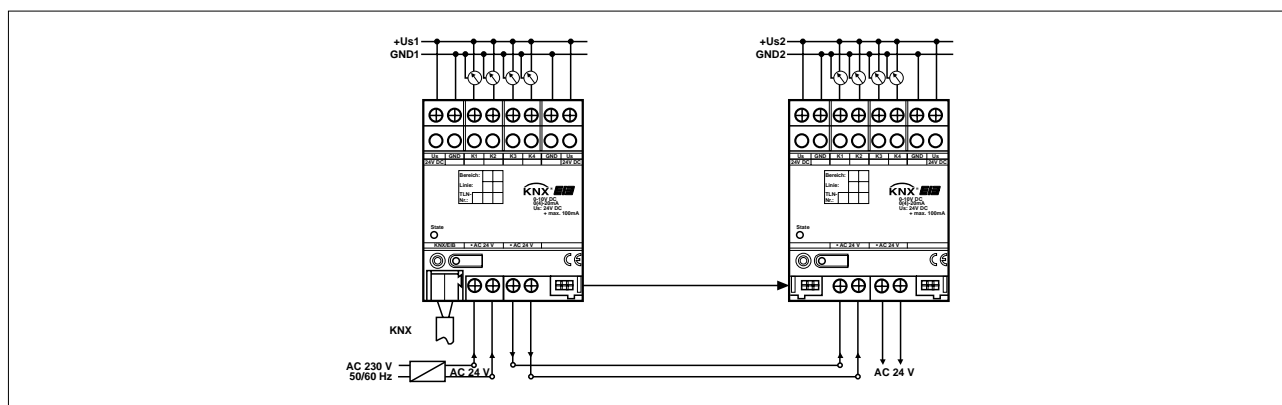

Remarks on the Hardware

- The GND terminals must not be connected to the corresponding terminals of another device.
- The outputs of the analog output and of the analog output extension module must not be connected to the 1 ... 10 V interface of electronic ballasts or electronic transformers.
- All connected components must ensure safe separation from other voltages.

Please observe the following basic rules when installing the analog output extension module:

- An analog output extension module is connected to the analog output only with the 6-pole system connector (supplied with the analog output extension module).
- One extension module only can be connected to the device.
- An analog output extension module can be replaced (e.g. in case of defect) while the system is in operation (disconnect the voltage supply from the module). After the replacement, the analog output makes a reset after abt. 25 s. This action re-initializes all outputs and resets them to their original state.
- Removal or addition of modules without adapting the project and subsequent downloading into the analog output is not permitted as this will result in system malfunctioning.
- The GND terminals of the analog output extension module must not be connected to the corresponding terminals of another device, e.g. the analog output.
- After initial start-up, the analog output performs a module scan (status LED: "orange/on").
- Since a new device contains generally no project, the status LED switches thereafter to "red/flashing fast".

5 Application

Objects

Number of addresses:	200
Number of assignments:	200
Communication objects:	58

Object	Function	Name	Type	DP-Type	Flag
0 ... 3	Input value output 1 ... 4	Analog output	9.0xx	2 Bytes	C, W, T ¹⁾
0 ... 3	Input value output 1 ... 4	Analog output	5.001	1 Byte	C, W, T ¹⁾
4 ... 7	Status output 1 ... 4	Analog output	9.0xx	2 Bytes	C, R, T ¹⁾
4 ... 7	Status output 1 ... 4	Analog output	5.001	1 Byte	C, R, T ¹⁾
8 ... 15	Forced control 1 / 2 output 1 ... 4	Analog output	1.001	1 Bit	C, W, T ²⁾
16 ... 19	Switching output 1 ... 4	Analog output	1.001	1 Bit	C, W, T ²⁾
20 ... 23	Dimming output 1 ... 4	Analog output	3.007	4 Bits	C, W, T
24 ... 27	Alarm output 1 ... 4	Analog output	1.001	1 Bit	C, R, T
29 ... 32	Input value output 5 ... 8	Extension module	9.0xx	2 Bytes	C, W, T
29 ... 32	Input value output 5 ... 8	Extension module	5.001	1 Byte	C, W, T ⁴⁾
33 ... 36	Status output 5 ... 8	Extension module	9.0xx	2 Bytes	C, R, T ⁴⁾
33 ... 36	Status output 5 ... 8	Extension module	5.001	1 Byte	C, R, T ⁴⁾
37 ... 44	Forced control 1 / 2 Output 5 ... 8	Extension module	1.001	1 Bit	C, W, T ^{3) 4)}
45 ... 48	Switching output 5 ... 8	Extension module	1.001	1 Bit	C, W, T ⁴⁾
49 ... 52	Dimming output 5 ... 8	Extension module	3.007	4 Bits	C, W, T ⁴⁾
53 ... 56	Alarm output 5 ... 8	Extension module	1.001	1 Bit	C, R, T ⁴⁾
57	Alarm	Extension module	1.001	1 Bit	C, R, T ⁴⁾

¹⁾ The type of the "Input value ..." and "Status ..." objects depends on the setting of the "Input format" parameter.

²⁾ The "Switching" and "Dimming" objects of an output are visible only if the "Input format" parameter is set to "8 bits".

³⁾ The "Forced control" objects of an output are visible only if the "Forced control object" parameter is set to "Forced control active with ...".

⁴⁾ Objects 29 57 are visible only if the "Extension module present" parameter is set to "Yes".

Scope of functions:

For each channel separately programmable:

- Type of signal output (0 ... 10 V, 0 ... 1 V, 0 ... 20 mA, 4 ... 20 mA)
- Format of input value (8-bit or 16-bit) presettable
- Dimming actuator operation (with 8-bit input objects)
- Output value after initialization
- Up to two forced-control modes
- Cyclical monitoring of input values
- Response in the event of exceeding of monitoring time presettable
- Response to bus voltage failure presettable
- Response on return of bus voltage presettable

Analog output Extension Module

1

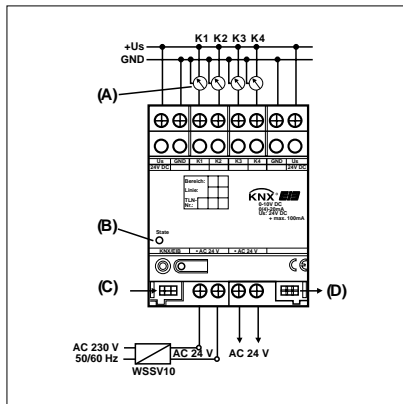

2

	Ref.-No.
Analog output module (No KNX device)	2204.01 REG AM
Series embodiment (SE)-device (4 units)	

3

The analog output extension module exceeds a KNX Analog output, 2204.01 REGA by four additional sensor outputs. The analog output extension module offers four analog outputs which can be software parameterised for one of the following ranges. Outputs not used can be deactivated.

Voltage signals:	0 ... 1 V DC	0 ... 10 V DC
Current signals:	0 ... 20 mA DC	4 ... 20 mA DC

The analog output extension module needs an external 24 V power supply, WSSV 10.

4

Technical data

Supply voltage:	24 V AC \pm 10 %
Current consumption:	max. 170 mA
Power consumption at system plug:	typ. 150 mW
Connection:	Screw terminals: 0.5 mm ² to 4 mm ² , single-wire 0.34 mm ² to 4 mm ² , fine-wire (without ferrule) 0.14 mm ² to 2.5 mm ² , fine-wire (incl. ferrule)
Connection to KNX device:	6-pole system plug
Sensor input:	4 x analog
Output signal load:	voltage signal: \geq 1 k Ω current signal: \leq 100 Ω
Output current:	voltage signal: max. 10 mA per channel current signal: max. 20 mA per channel
Connection:	Screw terminals: 0.5 mm ² to 4 mm ² , single-wire 0.34 mm ² to 4 mm ² , fine-wire (without ferrule) 0.14 mm ² to 2.5 mm ² , fine-wire (incl. ferrule)
Protection:	IP 20
Safety class:	III
Ambient temperature:	-5°C ... +45°C
Storage/transport temperature:	-25°C ... +70°C (storage above +45°C reduces the lifetime)

Time Switch

2 channel

1



2

	Ref.-No.
KNX time switch, 2 channel	2152 REG
ETS-product family:	Time switch
Product type:	Timer
Series embodiment (SE)-device (2 units)	

3

The 2 channel time switch can be used as a daily or as a weekly time switch. On each channel, switching, priority, brightness values or value messages (commands) can be transmitted at determined times.
The time switch offers: 36 captive switching times which are programmable by free block formation on one, several or all weekdays.
In addition the device is already programmed ex factory with valid Middle-European switching for automatic summer/winter time switching and actual time.
If another or no switching is required, this can be programmed as described in the operating instruction.

4

Technical data:

Supply	
Voltage:	24 V DC (+6 V / -4 V)
Power consumption:	< 2 mA
Connection:	KNX connection bus
Power reserve:	6 years at +20°C
Programmable:	every minute
Memory locations:	36
Sommer/winter:	adjustment automatically
Protection:	IP 20
Operation temperature:	-5°C ... +45°C
Mounting:	on DIN rail 35 x 7.5

5

Description of application

2 scenes with switching, value, priority

On each of the 2 channels you can choose between the following telegram types:

- switching telegram (1 Bit)
- priority telegram (2 Bit)
- brightness value or value telegram (8 Bit)

Cyclic transmitting can be selected for each channel, this is controlled by a common timer. In addition the possibility exists of suppressing the time switch program of the clock by control of a blocking object via the bus.

The characteristic of the blocking object and its influence on the transmission behaviour of the individual channel objects can be adjusted by parameters.

This could be an ideal application for private homes or smaller KNX projects.

During a switching time, up to four telegrams (commands) can be transmitted via bus on one channel (end of a working day: switch off main lighting, drive shutter down, lower ambient temperature, lock external doors).

These additional objects can be a 1 or 2 Bit or a 1 Byte type.

Objects

Number of addresses:	11
Number of assignments:	11
Communication objects:	9

Object	Name	Function	Type	Flag
Scene – objects channel 1, operation mode: switching				
0	Channel 1 – object 1	Send switching telegram	1 Bit	C, R, T
1	Channel 1 – object 2	Send switching telegram	1 Bit	C, R, T
2	Channel 1 – object 3	Send switching telegram	1 Bit	C, R, T
3	Channel 1 – object 4	Send switching telegram	1 Bit	C, R, T
Scene – objects channel 2, operation mode: switching				
4	Channel 2 – object 1	Send switching telegram	1 Bit	C, R, T
5	Channel 2 – object 2	Send switching telegram	1 Bit	C, R, T
6	Channel 2 – object 3	Send switching telegram	1 Bit	C, R, T
7	Channel 2 – object 4	Send switching telegram	1 Bit	C, R, T
Scene – objects channel 1, operation mode: value transmitter				
0	Channel 1 – object 1	Send value telegram	1 Byte	C, R, T
1	Channel 1 – object 2	Send value telegram	1 Byte	C, R, T
2	Channel 1 – object 3	Send value telegram	1 Byte	C, R, T
3	Channel 1 – object 4	Send value telegram	1 Byte	C, R, T
Scene – objects channel 2, operation mode: value transmitter				
4	Channel 2 – object 1	Send value telegram	1 Byte	C, R, T
5	Channel 2 – object 2	Send value telegram	1 Byte	C, R, T
6	Channel 2 – object 3	Send value telegram	1 Byte	C, R, T
7	Channel 2 – object 4	Send value telegram	1 Byte	C, R, T
Scene – objects channel 1, operation mode: priority				
0	Channel 1 – object 1	Send priority telegram	2 Bit	C, R, T
1	Channel 1 – object 2	Send priority telegram	2 Bit	C, R, T
2	Channel 1 – object 3	Send priority telegram	2 Bit	C, R, T
3	Channel 1 – object 4	Send priority telegram	2 Bit	C, R, T
Scene – objects channel 2, operation mode: priority				
4	Channel 1 – object 1	Send priority telegram	2 Bit	C, R, T
5	Channel 1 – object 2	Send priority telegram	2 Bit	C, R, T
6	Channel 1 – object 3	Send priority telegram	2 Bit	C, R, T
7	Channel 1 – object 4	Send priority telegram	2 Bit	C, R, T
Blocking function				
8	Blocking	Receive blocking telegram	1 Bit	C, W, T

Time Switch

4 channel

1



2

	Ref.-No.
KNX time switch, 4 channel	2154 REG
ETS-product family:	Time switch
Product type:	Timer
Series embodiment (SE)-device (6 units)	

3

The 4 channel time switch controls connected bus participants via group addresses. It transmits either 1, 2 or 8 Bit telegrams, including the time. With the time program and the corresponding application, the time can be transmitted and received via the bus. As an option, the programming can be done on a PC by using the special software OBELISK. The prepared file can be written onto the memory card and also be printed out.

The time switch has the following features:

- BCU integrated into the unit
- 324 switching times for free assignments
- permanent switching times by means of EEPROM
- day/week/year program
- random program
- pulse program
- switching times: ON or OFF delay
- 1 x function for all date-related switching times
- 10 priority programs consisting of 10 individual weekly programs per channel
- automatic setting of public holidays without fixed date (ie. Easter)
- approx. 1.5 years battery reserve by means of exchangeable environmentally friendly lithium cell
- it can be programmed up to the year 2063 in advance
- data transmission and data backup possible with memory card
- possible functions: switching, dimming transmitting time, receiving time
- option: radio controlled, hence automatic synchronisation of summer/winter time by means of the DCF 77 signal
- power supply for DCF receiver is integrated
- PC programming recommended by using the special software set OBELISK

4 Technical data:

Supply	
Voltage:	24 V DC (+6 V / -4 V)
Power consumption:	max. 150 mW
with DCF:	230 V for integrated power supply
Connection:	KNX connection block
Power reserve:	1.5 years, CR2450 3 V/560 mA
Programmable:	every second
Memory locations:	324
Special programs:	9 week-programs
Antenna:	for DCF 77 signal
Protection:	IP 20
Operation temperature:	-5°C ... +45°C
Mounting:	on DIN rail 35 x 7,5
Max. distance of DCF:	200 m

5 Description of some features

Priority Program

The programming of a priority consists of:

1. input of switching times,
2. determination of a beginning and final date.

If the period of several priority programs overlaps, then always the program with the highest index is active.

For example the week program P2 overrides the week program P1.

Random Program

The random program causes random ON and OFF switching in the period from 10 to 120 minutes between one or more switching pairs (switch ON and OFF time). For each channel the random program can be switched on manually via keyboard.

Function "1 x"

The function "1 x" can be used for date-specific switching times and for priority periods. After the execution of the date-specific switching time, the switching time is deleted automatically at midnight in the clock. Likewise a priority period which was occupied with the function "1 x" was deleted after the operating time. However, the switching times in the clock, corresponding to the priority period, are preserved.

Thus the function "1 x" can be used meaningfully with the programming of the time switch program for holidays and holiday programs as well as movable holiday programs.

The time synchronisation

The time synchronisation of the time switch can be made by the DCF 77-radio signal (antenna and power supply are necessary), by means of the bus via reception of a date and time message or automatically quartz-controlled.

Programming of the switching time programs

Complete switching time programming can be made directly on the device by means of key input or by the PC using the special programming set OBELISK. The OBELISK memory chip is not part of delivery!

The software OBELISK permits e.g.:

- to program switching times into a EEPROM memory module
- to select switching times from the EEPROM memory module
- to archive switching times on fixed disk in the PC
- to print out switching times in a table
- to copy sections from an available switching time program and to insert them into a new or already available program
- to define a new rule for the summer/winter time (if no DCF antenna is attached)

5

Description of application

1. Scene with switching, value priority

On each of the 4 channels you can choose between the following telegram types:

- switching telegram (1 Bit)
- priority telegram (2 Bit)
- brightness value or value telegram (8 Bit)

Cyclic transmitting can be selected for each channel, this is controlled by a common timer.

By choice, a switching, priority or value telegram (command) can be sent on each of the channels 1 to 3.

Additionally a scene with up to 4 types of telegram (command) can be implemented on the 4th channel.

During a switching time, up to four telegrams (commands) can be transmitted via bus on channel 4 (end of a working day: switch off main lighting, drive shutter down, lower ambient temperature, lock external doors).

These additional objects can be a 1 or 2 Bit or a 1 Byte type.

In addition the possibility exists of suppressing the time switch program of the clock by control of a blocking object via the bus.

Objects

Number of addresses:	10
Number of assignments:	10
Communication objects:	8

Object	Name	Function	Type	Flag
0	Channel 1	Send telegram switch	1 Bit	R, T
1	Channel 2	Send telegram switch	1 Bit	R, T
2	Channel 3	Send telegram switch	1 Bit	R, T
3	Channel 4	Send telegram switch	1 Bit	R, T
7	Block	Reception telegram block	1 Bit	W, T

max. extension with four switch messages (commands) on channel 4:

0	Channel 1	Send telegram switch	1 Bit	R, T
1	Channel 2	Send telegram switch	1 Bit	R, T
2	Channel 3	Send telegram switch	1 Bit	R, T
3	Channel 4 object 1	Send telegram switch	1 Bit	R, T
4	Channel 4 object 2	Send telegram switch	1 Bit	R, T
5	Channel 4 object 3	Send telegram switch	1 Bit	R, T
6	Channel 4 object 4	Send telegram switch	1 Bit	R, T
7	Block	Reception telegram block	1 Bit	W, T

Description of application

2. Switching, value, send time and date

On each of the 4 channels you can choose between the following telegram types:

- switching telegram (1 Bit)
- priority telegram (2 Bit)
- brightness value or value telegram (8 Bit)

Cyclic transmitting can be selected for each channel, this is controlled by a common timer.

By choice, a switching, priority or value telegram (command) can be sent on each of the channels 1 to 3.

Date and time-of-day can be transmitted each minute, each hour, each day or only on request.

Date and time-of-day are always transmitted together.

Objects

Number of addresses:	8
Number of assignments:	8
Communication objects:	7

Object	Name	Function	Type	Flag
0	Channel 1	Send telegram switch	1 Bit	R, T
1	Channel 2	Send telegram switch	1 Bit	R, T
2	Channel 3	Send telegram switch	1 Bit	R, T
3	Channel 4	Send telegram switch	1 Bit	R, T
4	Time	Send time	3 Byte	R, T
5	Date	Send date	3 Byte	R, T
6	Time demand	Ask for time + date	1 Bit	W, T

5

Description of application

3. Switching, value, temperature, receive time and date

On each of the 4 channels you can choose between the following telegram types:

- switching telegram (1 Bit)
- priority telegram (2 Bit)
- brightness value or value telegram (8 Bit)
- temperature telegram (16 Bit)
- any telegram in the EIS 5 format (16 Bit)

Cyclic transmitting can be selected for each channel, this is controlled by a common timer.

By choice, a switching, priority or value telegram (command) can be sent on each of the channels 1 to 3.

Furthermore the time switch can receive time and date telegrams for temporal synchronisation.

The adjustment of any message in the EIS 5 form requires appropriate mathematical knowledge.

Objects

Number of addresses:	8
Number of assignments:	8
Communication objects:	6

Object	Name	Function	Type	Flag
0	Channel 1	Switch	1 Bit	R, T
1	Channel 2	Switch	1 Bit	R, T
2	Channel 3	Switch	1 Bit	R, T
3	Channel 4	Switch	1 Bit	R, T
4	Time	Set time	3 Byte	W, T
5	Date	Set date	3 Byte	W, T

Time Switch

16 channel

1



2

	Ref.-No.
KNX year time switch, 16 channel	2156 REG
ETS-product family:	Time switch
Product type:	Timer
Series embodiment (SE)-device (6 units)	

3

Depending on the time of day, the programmed switching times and the parameterization of the application program, the 16-channel year time switch transmits telegrams to the KNX for up to 16 independent channels. These can be switching, value transmission, forced control or HVAC operating mode switch-over telegrams in accordance with KNX.

Moreover, up to 8 scenes with 6 scene objects each and 4 disable objects can be implemented.

Master/Slave time synchronization / DCF77 synchronization

Depending on parameterization, the time can be transmitted to or received from the bus and therefore be synchronized.

As an alternative, the time can be synchronized by means of a DCF77 antenna.

Display

The display shows the channel status, operating mode, date, day of the week and time of day.

Time switch keypad

The keypad permits entering the date, the time of day and the switching programs as well as the direct selection of individual channels.

Obelisk PC programming tool, Obelisk memory chip

The Obelisk programming tool permits easy compilation of switching event times on a PC and interchange between time switch and PC by means of a data interface. The storage device in this case is the Obelisk memory chip.

Scope of functions for programming of switching times

- Day programs/week programs and year programs
- Random switching programs
- Pulse function
- Weekday and channel groups facility
- "1 x" function (switching command is executed only once)
- Public holiday program (annual adaptation of movable holidays)
- Automatic summer/winter time change-over adaptable for international purposes
- Astro program
- Manual permanently ON/permanently OFF switching (via timer switch)
- Priority assignment
- Switching time simulation (only via Obelisk programming software)

4 Technical data

KNX Supply	
Voltage:	21 – 32 V DC (SELV)
Power consumption:	< 150 mW
Connection:	KNX connecting and branch terminal
External supply:	only required in case of DCF77 antenna connection
Voltage:	230 V ± 10 %
Power consumption:	< 150 mW
Connection:	Screw terminals
Type of protection:	IP 20
Safety class:	II
Mark of approval:	KNX
Ambient temperature:	-5°C ... +45°C
Storage/transport temperature:	-25°C ... +70°C (storage above +45°C reduces the lifetime)
Mounting position:	any
Minimum distances:	none
Fastening:	Snap-fastening on DIN rail (data rail not required)
Memory locations:	500 (free grouping)
Shortest switching interval:	1 second/minute
Shortest pulse:	1 second
Switching accuracy:	precise to the second
Accuracy:	± 1 s/day at 20°C or radio time signal precision (with DCF77)
Running reserve:	Lithium cell approx. 1.5 years (20°C), CR2450, 3 V/560 mA

DCF77 antenna

Type of protection:	IP 54
Ambient temperature:	-20°C ... +70°C
Mounting position:	orientation as shown in wiring diagram
Receiving range:	1000 km from Frankfurt a.M., Germany
Connection:	max. 1.5 mm ²
Max. distance of antenna:	200 m
Max. loading:	10 devices
Fastening:	Holes in enclosure for fastening screws Fastening with brackets supplied with the device

Response at mains failure

Bus voltage only:	software-dependent (see software information)
Mains voltage only:	DCF77 reception not possible, if so equipped
Bus and mains voltage:	-
Response on return of supply	
Bus voltage only:	software-dependent (see software information)
Mains voltage only:	DCF77 reception not possible, if so equipped
Bus and mains voltage:	-

Battery

In the event of bus failure, the battery is activated automatically to supply the time switch (not the BCU). In this case, the application module is fully operational (display dark). The switching time programs remain stored in the internal EEPROM.

Current is drawn from the battery only in the event of bus failure (running reserve = approx. 1.5 years).

The battery has a lifetime of approx. 10 years. Observe the polarity when inserting the battery.

DCF77

The internal power supply unit for the DCF77 antenna is connected to the L and N terminals.

Connection to the mains is not required if the device is operated without DCF77.

The KNX bus (the battery in case of bus failure) supplies the operating voltage for the timer clock (incl. date and time-of day). Make sure to connect first the mains and then the bus voltage.

The antenna signal consists of safety extra-low voltage (SELV) with a level of 9 V.

The LED antenna flashes once every second to indicate that the antenna is properly aligned.

• Commissioning of a single time switch

In the event of only one time switch being in operation, the polarity of the antenna line is irrelevant.

• Commissioning of several time switches (with common antenna)

1. If several time switches are operated together, the polarity of the antenna cable must be the same for all devices:
 - Connect the antenna cable to all year time switches.
 - Connect the mains voltage only to one time switch.
 - The false-polarity LED indicates an incorrect connection of the antenna cable to a time switch.
2. Connect the mains voltage to all other time switches.

4 Obelisk memory chip

For the transfer of data, only the Obelisk memory card 64K (supplied with the 16-channel year time switch) can be used. Data transfer with the Obelisk memory card (2154 EEPROM) for the old KNX 4-channel year time switch REG is not possible!

Requirements: Programming software Obelisk 2.1 + Obelisk interface box V2.0 + Obelisk memory card 64K.

The "Obelisk" memory chip has the following functions:

1. Keypad lock

The access to the time switch by means of the built-in keypad can be disabled and re-enabled with the help of the Obelisk memory chip. The activation and deactivation procedure is described in the operating instructions.

Exception:

Re-initialization with the reset key is possible. If the automatic re-synchronization is interrupted, the date can be changed manually.

During the next synchronization cycle, the device will, however, be automatically reset to the actual time.

The keypad lock remains active after an operating voltage failure.

2. Storage device

The memory chip is the storage device for switching programs.

5 Scope of functions:

- Transmission of telegrams on 16 channels depending on time switch programming with the following functions: switching, value transmitter (1 byte), forced control or HVAC operating mode switch-over (KNX).
- Use of 8 scenes with 6 output objects each (accessible via each channel) with the following functions: switching value transmitter (1 byte), forced control or HVAC operating mode switch-over (KNX) or temperature value transmitter.
- Cyclical transmission parameterizable for each channel object.
- Up to 4 disable objects for disabling of parameterizable channels.
- Use as time and date transmitter (Master) with transfer of the information to the bus after optional addition of the DCF77 receiver. Alternative use as time and date receiver (Slave) with reception of the information from the bus. In the master mode, a time request via a trigger object is possible.
- Cyclical transmission of time and date information to the bus in the master mode.

Time Switch Accessories



2		Ref.-No.
	Software set for OBELISK memory card	2154 PC

3 The programming set consists out of an OBELISK memory card for the data transmission between PC and time switch, a programming adapter and the software.
The memory card can be used as data backup or for the transmission of the program from time switch to time switch.

2		Ref.-No.
	OBELISK memory card	2154 EEPROM

3 Memory card with EEPROM used for data transmission between PC and 4 channel time switch 2154 REG.

2		Ref.-No.
	DCF receiver	2154 DCF

3 Receiver module for the DCF77 radio signal.

4	Technical data	
	Protection:	IP 54
	Connection:	3 x 1.5 mm ² , max. 200 m
	Distance:	1000 km Frankfurt a.M. (Germany)

Actuators

Switching – Flush mounted

1

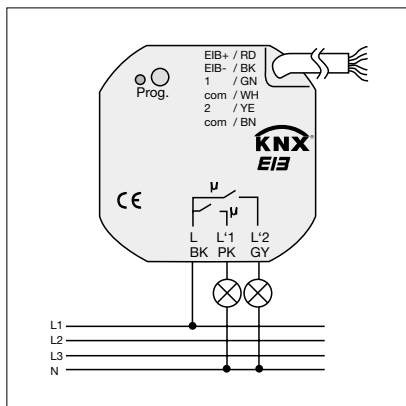
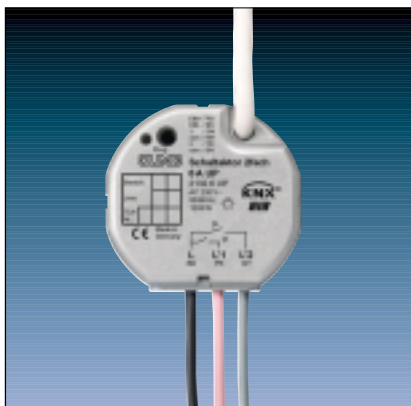
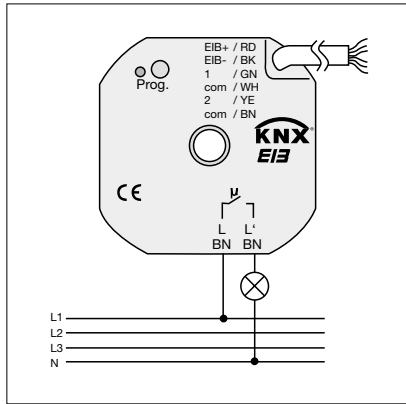
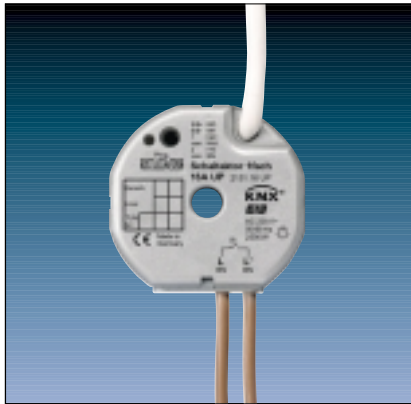

2

	Ref.-No.
KNX switch actuator, flush mounted	
1-gang	2131.16 UP
2-gang	2132.6 UP
ETS-product family:	Output
Product type:	1(2)-gang binary output

3

The switching actuator receives telegrams from sensors via the KNX and switches an electrical load with its relay-output. The device is equipped with two extension inputs which – depending on parameterization – can act directly on the switching output (local control / only input 1, input 2 without function) or alternatively as binary inputs on the KNX. The connected potential-free switch or push-button contacts are sensed against a common reference potential at the switching actuator. As a binary input, the device can transmit telegrams for switching or dimming, for shutter/blind control or for value transmitter applications (dimming value transmitter, light-scene extension). Connecting 230 V signals or other external voltages to the extension inputs is not permitted. The switching actuator is supplied from the KNX and needs no additional external power supply.

4

Technical data

KNX supply	
Cable type:	YY 6 x 6.0 mm; red: bus (+) / black: bus (-)
Voltage:	21 – 32 V DC SELV
Power consumption:	typically 150 mW
Connection:	approx. 33 cm ready-made; connecting terminal (0.6 – 0.8 mm)
Input	
Number:	2 (depending on parameterization either as extension inputs for push-button local control of the actuator or as independent binary inputs acting on the bus)
Cable type:	YY 6 x 0.6 mm green: extension input 1 white: reference potential (com) yellow: extension input 2 brown: reference potential (com)
Cable length:	approx. 33 cm ready-made, extendible to 5 m max.
Scanning voltage:	approx. – 19 V DC referred to “com”; continuous signal
Loop resistance:	max. 2 kOhm for safe “1” signal detection (rising edge)
Output, for 2131.16 UP	
Number:	1
Cable type:	2 x H05 V-K 2.5 mm ² with ferrules
Cable length:	approx. 20 cm ready-made
Switch type:	make-contact, potential-free (μ-contact) bistable
Switching voltage:	230 V AC; 50/60 Hz
Max. switching current:	16 A
Max inrush current:	400 A, 20 ms
Switching capacity:	Incandescent lamps 2.500 W (at 100.000 switching operations) HV halogen lamps 2.200 W (at 100.000 switching operations) LV halogen lamps inductive transformers 1.000 VA electronic transformers 1.000 W capacitive loads 230 V AC, 10 A switching current, max. 105 μF
Output, for 2132.6 UP	
Number:	2 (with common phase connection “L”)
Cable type:	3 x H05 V-K 2.5 mm ² with ferrules
Cable length:	approx. 20 cm ready-made
Switch type:	make-contact, potential-free (μ-contact) bistable
Switching voltage:	230 V AC; 50/60 Hz
Max. switching current:	6 A for each output
Max inrush current:	120 A, 20 ms
Switching capacity:	Incandescent lamps 1.200 W (at 25.000 switching operations) HV halogen lamps 1.200 W (at 25.000 switching operations) LV halogen lamps inductive transformers 500 VA electronic transformers 500 W capacitive loads 230 V AC, 6 A switching current, max. 14 μF
Protection:	IP 20
Safety class:	III
Mark of approval:	KNX
Ambient temperature:	–5°C ... +45°C
Storage/transport temperature:	–25°C ... +70°C (storage above +45°C results in shorter lifetime)
Mounting position:	any
Minimum spacings:	none
Fastening:	e.g. placing into deep flush-mounting box (Ø 60 mm x 60 mm)

4

Note:

- Never connect the mains voltage (230 V) or other external voltages to the extension inputs.
Connecting an external voltage endangers the electrical safety of the entire KNX system (SELV / no electrical insulation).
Persons may be put at risk and devices and installations may suffer irreparable damage.
- Make sure during the installation that there is always sufficient insulation between the mains voltage and the bus or the extensions.
A minimum spacing of 4 mm must be ensured between the bus/extension wires and the mains wires.
- Non-used wires of the 6-wire connecting cable must be insulated with respect to one another and with respect to external voltages.
- To avoid EMC disturbances, the lines to the inputs should not be laid parallel to lines and cables carrying mains voltage.

Output:

- Output(s) parameterizable as n.o. contact (ON: contact closes / OFF: contact opens) or as n.c. contact (ON: contact opens / OFF: contact closes).
- Preferred state on return of bus voltage presettable.
- For the output additional feedback and additional function possible:
Presettable additional functions: – logic-operation function with 3 logic parameters
– disabling function with presettable disabling behaviour of the relays
– priority-position function to fix the priority of arriving switching telegrams
- Feedback object invertible.
- Delay on return of bus voltage centrally presettable.
- Turn-on delay and/or turn-off delay or timer function separately presettable for each output.

5

Description of software application

Objects	2131.16 UP	2132.6 UP
Number of addresses:	26	26
Number of assignments:	27	27
Communication objects:	9	12

Objects for the binary inputs (extension inputs), if acting on the bus:

Object	Name	Function	Type	Flag
Function: "Switching" (for all 2 inputs ²)				
2 – 3	Input 1 – Input 2	Switching object X.1 (X = 1 to 2)	1 Bit	C, W, T, (R) ¹
10 – 11	Input 1 – Input 2	Switching object X.2 (X = 1 to 2)	1 Bit	C, W, T, (R) ¹
Function: "Dimming" (for all 2 inputs ²)				
2 – 3	Input 1 – Input 2	Switching	1 Bit	C, W, T, (R) ¹
10 – 11	Input 1 – Input 2	Dimming	4 Bit	C, T, (R) ¹
Function: "Shutter/blind" (for all 2 inputs ²)				
2 – 3	Input 1 – Input 2	Short operation	1 Bit	C, T, (R) ¹
10 – 11	Input 1 – Input 2	Long operation	1 Bit	C, T, (R) ¹
Function: "Value transmitter" (Function: Dimming value transmitter for all 2 inputs ²)				
2 – 3	Input 1 – Input 2	Value	1 Byte	C, T, (R) ¹
Function: "Value transmitter" (Function: Light-scene extension with/without storage function for all 2 inputs ²)				
2 – 3	Input 1 – Input 2	Light-scene extension	1 Byte	C, T, (R) ¹
Function: "Disable" (for all 2 inputs ³)				
2 – 3	Input 1 – Input 2	Disabling	1 Bit	C, W, (R) ¹

¹: Objects marked (R) permit read-out of the object status (set R flag).

²: The "No function", "Switching", "Dimming", "Shutter/blind" and "Value transmitter" functions can be selected per input.

The names of the communication objects and the object table (dynamic object structure) will change accordingly.

³: A disable function is not available if the inputs are parameterized for "No function".

5 Description of software application

Objects for the output of 2131.16 UP

Object	Name	Function	Type	Flag
0	Output 1	Switching	1 Bit	C, W, (R) ¹
Function: "Additional function for the output = "Logic-operation object"				
8	Output 1	Logic function	1 Bit	C, W, (R) ¹
Function: "Additional function for the output = "Disabling object"				
8	Output 1	Disabling	1 Bit	C, W, (R) ¹
Function: "Additional function for the output = "Priority-position object"				
8	Output 1	Priority operation	1 Bit	C, W, (R) ¹
Function: "Acknowledge"				
16	Output 1	Acknowledge	1 Bit	C, W, (R) ¹

Objects for the output of 2132.6 UP

Object	Name	Function	Type	Flag
0 – 1	Output 1 – 2	Switching	1 Bit	C, W, (R) ¹
Function: "Additional function for the output = "Logic-operation object"				
8 – 9	Output 1 – 2	Logic function	1 Bit	C, W, (R) ¹
Function: "Additional function for the output = "Disabling object"				
8 – 9	Output 1 – 2	Disabling	1 Bit	C, W, (R) ¹
Function: "Additional function for the output = "Priority-position object"				
8 – 9	Output 1 – 2	Priority operation	1 Bit	C, W, (R) ¹
Function: "Acknowledge"				
16 – 17	Output 1 – 2	Acknowledge	1 Bit	C, W, (R) ¹

¹ : Objects marked (R) permit read-out of the object status (set R flag).

Actuators

Switching 2-gang

1



2

	Ref.-No.
KNX switch actuator, 2-gang, 16 A	2132.16 REG (will be replaced by 2302.16 RECHM)
ETS-product family:	Output
Product type:	2-gang binary output
Series embodiment (SE)-device (4 units)	

3

The switching actuator 2-gang receives telegrams and switches electrical loads by two floating contacts. The switch performance of the output is configured as a make-contact. Depending on the parameter, the actuator can be switched On/Off directly, with On/Off time delays or as a time switch. Additionally it offers the possibility of logical link and acknowledge operation. The behaviour of a bus voltage drop/recovery can be parameterised. The device provides 2 hardware slide switches to be actuated manually without any effect on the bus.

4

Technical data

Supply		
Voltage:	24 V DC (+6 V / -4 V)	
Power consumption:	max. 150 mW	
Connection:	KNX connection block	
Output		
Number:	2	
Performance:	2 floating make-contacts	
Rated voltage:	230 V AC; 400 V AC	
Max. current:	16 A / AC-1; 10 A / AC-3 at 230 V AC 10 A / AC-1; 6 A / AC-3 at 400 V AC	
Capacity:	Incandescent :	2500 W
	Fluorescent, not comp. cos. $\varphi = 0,5$:	2500 W
	Fluorescent, parallel comp. cos. $\varphi = 1$:	1300 W / 140 μ F
	Fluorescent, duo-circuit, cos. $\varphi = 1$:	2 x 2500 W
	HV- halogen:	2500 W
Connection:	screw terminals: 0,2 – 4 mm ²	
Protection:	IP 20	
Operation temperature:	-5°C ... +45°C	
Storage temperature:	-25°C ... +70°C	
Mounting:	on DIN rail 35 x 7.5	

Notes:

- Different lines can be connected to the device.
- A manual switching by the slide switches is not detected by the software! If a channel is blocked via bus, it can be switched by the slide switch.
- The two relay outputs do not switch simultaneously, there is always a small time delay between due to the power supply from the bus. This has to be considered with applications having a high switching frequency.

5 Description of software application

- Switching of 2 independent channels.
- Hand operation possible.
- Outputs can be adjusted as make or brake contacts.
- Preferred contact position in case of bus voltage drop or recovery adjustable.
- 3 objects per output: switching, acknowledge and additional function.
- Adjustable additional functions:
 - Logical link with 3 logical parameter
 - Disable function
 - Forced position function
- Acknowledge object can be inverted.
- Switch ON and/or switch OFF time delay can be adjusted for each channel separately.

Objects

Number of addresses (dynamic):	32
Number of assignments (dynamic):	32
Communication objects:	6

Object	Name	Function	Type	Flag
0	Output 1	Switching	1 Bit	C,W
1	Output 2	Switching	1 Bit	C,W
Logical link function to the corresponding channel 1 – 2				
8	Output 1*	Logical link	1 Bit	C,W
9	Output 2*	Logical link	1 Bit	C,W
Disable link function to the corresponding channel 1 – 2				
8	Output 1*	Disable	1 Bit	C,W
9	Output 2*	Disable	1 Bit	C,W
Forced link function to the corresponding channel 1 – 2				
8	Output 1*	Forced position	2 Bit	C,W
9	Output 2*	Forced position	2 Bit	C,W
Acknowledge objects to the corresponding channel 1 – 2				
12	Output 1	Acknowledge	1 Bit	C,T
13	Output 2	Acknowledge	1 Bit	C,T

Objects marked with* can be assigned to any channel.

Notes to software application:

Forced position object

With the forced position object the switching channel can be forced separately via a 2 Bit telegram to a desired position, independent of its switching object. Here the parameter "relay-operation" is also effective.

The 2 Bit-telegram must be built up as follows:

Bit 1	Bit 0	Function
0	X	Priority not active → 'switching' object
0	X	Priority not active → 'switching' object
1	0	Priority active → switch Off
1	1	Priority active → switch On

The first Bit (Bit 0) of the forced position object, sets the forced switching position. The second Bit (Bit 1) releases the forced position function. At active 'forced position' function (priority), the incoming telegrams will be evaluated internally. Afterwards, at inactive 'forced position' function (priority), the actual internal switching condition will adjust the switching object accordingly.

Acknowledge object

The acknowledge object will be updated e.g. at bus voltage recovery and can be read out by any display or visualization (set R-flag!).

Actuators

Switching 6-gang

1



2

	Ref.-No.
KNX switch actuator,	
6-gang, 6 A	2136.6 REG
ETS-product family:	Output
Product type:	6-gang binary output
Series embodiment (SE)-device (4 units)	

3

The 6-gang switch actuator receives telegrams and switches electrical loads by six floating contacts. The switch performance of the output is configured as a make-contact. Depending on the parameters the actuator can be switched on/off directly, with on/off time delays or with a time switch. Additionally, there is the possibility of a logic link and acknowledge operation. The behaviour of a bus voltage drop/recovery can be parameterised.

4

Technical data

Supply	
Voltage:	24 V DC (+6 V / -4 V)
Power consumption:	150 mW
Connection:	KNX connection block
Output	
Number:	6
Performance:	floating make-contacts
Rated voltage:	230 V AC
Max. current:	6 A (ohmic load)
Capacity:	1000 W incandescent lamp 500 VA fluorescent lamp, uncompensated 2 x 500 W fluorescent lamp, duo-circuit 2 x 58 W (14 µF) fluorescent lamp, parallel comp.
Connection:	clamp bar
Protection:	IP 20
Insulation voltage:	referring to VDE 0660 T 102
Operation temperature:	-5°C ... +45°C
Mounting:	on DIN rail 35 x 7.5

Notes:

- The six relay outputs do not switch simultaneously, there is always a small time delay between due to the power supply from the bus. This has to be considered with applications having a high switching frequency.
- Different lines can be connected to the device.
- Do not connect 3 phase motors.

5 Description of application Switching RM, VK, ZF 206101

Functions

- Switching of 6 independent channels.
- Outputs can be adjusted as make- or break-contact.
- Preferred position in case of bus voltage drop or recovery adjustable.
- 4 adjustable outputs with 3 objects per output: switching, acknowledge and additional function.
- 2 adjustable outputs with 2 objects per output: switching, acknowledge.
- Adjustable additional functions:
 - Logical link with 3 logic parameter
 - Disable function
 - Forced position function
- Acknowledge object invertable.
- Switch ON and/or switch OFF time delay or time function can be adjusted for each channel separately.

Objects

Number of addresses (dynamic):	32
Number of assignments (dynamic):	32
Communication objects:	16

Object	Name	Function	Type	Flag
0	Output 1	Switch	1 Bit	C, W
1	Output 2	Switch	1 Bit	C, W
2	Output 3	Switch	1 Bit	C, W
3	Output 4	Switch	1 Bit	C, W
4	Output 5	Switch	1 Bit	C, W
5	Output 6	Switch	1 Bit	C, W
Logical link function to the selected channel 1 – 4:				
8	Output 1*	Logical link	1 Bit	C, W
9	Output 2*	Logical link	1 Bit	C, W
10	Output 3*	Logical link	1 Bit	C, W
11	Output 4*	Logical link	1 Bit	C, W
Disable function to the selected channel 1 – 4:				
8	Output 1*	Disable	1 Bit	C, W
9	Output 2*	Disable	1 Bit	C, W
10	Output 3*	Disable	1 Bit	C, W
11	Output 4*	Disable	1 Bit	C, W
Forced position function to the selected channel 1 – 4:				
8	Output 1*	Forced position	2 Bit	C, W
9	Output 2*	Forced position	2 Bit	C, W
10	Output 3*	Forced position	2 Bit	C, W
11	Output 4*	Forced position	2 Bit	C, W
Acknowledge function to the corresponding channel 1 – 6:				
12	Output 1	Acknowledge	1 Bit	C, T
13	Output 2	Acknowledge	1 Bit	C, T
14	Output 3	Acknowledge	1 Bit	C, T
15	Output 4	Acknowledge	1 Bit	C, T
16	Output 5	Acknowledge	1 Bit	C, T
17	Output 6	Acknowledge	1 Bit	C, T

Objects marked with* can be assigned to any channel.

5

Notes to software application:

Forced position object

With the forced position object the switching channel can be forced separately via a 2 Bit telegram to a desired position, independent of its switching object. Here the parameter "relay-operation" is also effective.

The 2 Bit-telegram must be built up as follows:

Bit 1	Bit 0	Function
0	X	Priority not active → 'switching' object
0	X	Priority not active → 'switching' object
1	0	Priority active → switch Off
1	1	Priority active → switch On

The first Bit (Bit 0) of the forced position object, sets the forced switching position. The second Bit (Bit 1) releases the forced position function. At active 'forced position' function (priority), the incoming telegrams will be evaluated internally. Afterwards, at inactive 'forced position' function (priority), the actual internal switching condition will adjust the switching object accordingly.

Acknowledge object

The acknowledge object will be updated e.g. at bus voltage recovery and can be read out by any display or visualization (set R-flag!).

Actuators

Switching 4-gang/8-gang

1



2

	Ref.-No.
KNX switch actuator,	
4-gang, 16 A	2304.16 REG HM
8-gang, 16 A	2308.16 REG HM
ETS-product family:	Output
Product type:	4-/8-gang binary output
Series embodiment (SE)-device (4/8 units)	

3

The switching actuator receives telegrams from sensors or other controls via the KNX and switches electrical loads by its independent contacts. Each switching output has a separate bistable relay, the switching state will be kept also at bus voltage drop. By means of the slide switches on top of the device, the relays can be operated by hand in parallel to the KNX without bus voltage or programming.

The functional scope for each output channel include extensive time functions, logics, scenarios, inhabit-functions, elapsed hour counter, cyclical monitoring and extended acknowledge functions. The preferred switching status at bus voltage drop/recovery or after download can be adjusted for each channel separately.

For projecting and commissioning the use of ETS 3.0d is recommended. Only with this ETS version or later versions the full functionality will be available (vd4-file).

For ETS2 and older versions of ETS3 separate databases are available (vd2-file).

The switching actuators are supplied by the KNX and do not need any additional external supply.

4

Technical data

KNX Supply	
Voltage:	21 – 32 V DC (SELV)
Power consumption:	typ. 150 mW
Connection:	Bus terminal (KNX Typ 5.1)
External supply:	–
Connection:	Screw terminals: 0.5 mm ² to 4 mm ² , solid or finely stranded conductor without wire end sleeve 0.5 mm ² to 2.5 mm ² , finely stranded conductor with wire end sleeve
	Stud torque max. 0.8 Nm
Total power loss:	4-gang actuator: max. 4 W 8-gang actuator: max. 8 W
Behavior at bus voltage drop:	Depending on parameter
Behavior at bus voltage recovery:	Depending on parameter

4 Technical data

Output	
Number:	4 / 8
Type:	Potential free, μ -contact, bistable
Rated voltage:	230 V AC, 50/60 Hz 400 V AC, 50/60 Hz 24 V DC
Rated current AC:	16 A / AC-1; 10 A / AC-3 at 230 V AC 10 A / AC-1; 6 A / AC-3 at 400 V AC
Rated current DC:	16 A / 24 V (ohmic)
Max. switch On current:	400 A, 150 μ s 200 A, 600 μ s
Min. switch current:	100 mA (at 24 V)
Switching Capacities	
Ohmic loads:	3600 W
Capacitive loads:	10 A, max. 140 μ F
Lamps	
Incandescent:	2500 W
HV-halogen:	2500 W
NV-halogen	
Conventional transformers:	1200 VA
Tronic transformers:	1500 W
Fluorescent T5 / T8	
not compensated:	2500 W
parallel compensated:	1300 W, 140 μ F
duo-circuit:	2300 W, 140 μ F
Compact fluorescent	
not compensated:	2500 W
parallel compensated:	1300 W, 140 μ F
Mercury-arc lamp	
not compensated:	2000 W
parallel compensated:	2000 W, 140 μ F
Ballasts:	The number of ballasts depends on the manufacturer and the type and the quality of the LV-net. The given figures are just examples. (Manufacturer: OSRAM)
	Max. number per output:
T8 Lamps:	QTP 3 x 18 W, 4 x 18 W 17 QTP 2 x 36 W 17 QTP 1 x 58 W 17 QTP 2 x 58 W 11
T5 Lamps:	QT-FH 1 x 28 W 17 QT-FH 2 x 28 W 17 QT-FH 2 x 54 W 11 QT-FH 1 x 80 W 11
Protection:	IP 20
Safety class:	III
Mark of approval:	KNX/VDE
Ambient temperature:	-5°C ... +45°C
Storage/transport temperature:	-25°C ... +70°C (storage above +45°C results in shorter lifetime)
Mounting position:	any, recommended: output terminals on top
Minimum spacings:	none
Fastening:	on DIN rail 35 x 7.5

Notes:

- Different lines can be connected to the device.
- A manual switching by the slide switches is not detected by the software! If a channel is blocked via bus, it can be switched by the slide switch.
- By e.g. a central command or high frequent switching, the relay outputs react with a small time delay.
- Do not connect three phase motors.

5 Scope of functions

- Switching of independent channels.
- Hand operation of relays is independent from the bus.
- Outputs can be adjusted as make or brake contacts.
- Central switching function with collective acknowledge.
- Acknowledge switching (only bus operation): Active (at changing of the output status) or passive (object can be read out).
- Logic functions for each output.
- Inhibit function for each output, alternatively forced position function.
- Time functions (Switch-on- and Switch-off-delay, staircase-function also with advance warning).
- Light scenes possible, up to 8 internal scenes per output.
- Elapsed hour counter per output.
- Monitoring of inputs for cyclical updating with safety position.
- Preferred contact position in case of bus voltage drop or recovery and download for each output adjustable.

Description of software application

Objects

Number of addresses:	254
Number of assignments:	255
Communication objects:	4-gang: 50 8-gang: 98

Superior channel objects:

Object	Function	Name	Type	DP-Type	Flag
--------	----------	------	------	---------	------

Function: Central function

□ ₁ 8	Central switching	All outputs	1 Bit	1.001	C, W, -, (R) ¹
Description:	1 Bit object for central switching of assigned outputs. The polarity can be defined.				

Function: Collective acknowledge

□ ₁ 9	Collective acknowledge	All outputs	4 Byte	27.001	C, T, R ²
Description:	4 Byte object for central acknowledge of the entire status of the actuator.				

Channel objects:

Object	Function	Name	Type	DP-Type	Flag
--------	----------	------	------	---------	------

Function: Switching

□ ₁ 10, 36, 62, 88, 114, 140, 166, 192 ³	Switching	Output 1 – 8 ³	1 Bit	1.001	C, W, -, (R) ¹
Description:	1 Bit object for controlling an output. ("1" = switch On / "0" = switch Off; please note the operation mode!)				

Function: Forced position

□ ₁ 11, 37, 63, 89, 115, 141, 167, 193 ³	Forced position	Output 1 – 8 ³	2 Bit	2.001	C, W, -, (R) ¹
Description:	2 Bit object for a forced positioning of an output. The object status after bus voltage recovery can be defined by parameter.				

Function: Inhibit

□ ₁ 12, 38, 64, 90, 116, 142, 168, 194 ³	Inhibit	Output 1 – 8 ³	1 Bit	1.003	C, W, -, (R) ¹
Description:	1 Bit object for inhibiting of an output. (The polarity can be defined.)				

Function: Logic link

□ ₁ 13, 39, 65, 91, 117, 143, 169, 195 ³	Logic link	Output 1 – 8 ³	1 Bit	1.002	C, W, -, (R) ²
Description:	1 Bit object for the input of a logic gate of an output. The object value after bus voltage recovery or after ETS-download can be pre-defined by parameter.				

¹ Each communication object can be read out. Set "R" flag.

² Depending on the parameter, acknowledge objects are either active (T-Flag set) or passive, can be read out (set R-Flag).

³ Number of outputs or communication objects acc. to the chosen device (4-gang = 4 outputs or 8-gang = 8 outputs).

5 Description of software application						
Object	Function	Name	Type	DP-Type	Flag	
Function: Stair-case function						
□↓ 14, 40, 66, 92, 118, 144, 170, 196 ³	Stair-case function Start/Stop	Output 1 – 8 ³	1 Bit	1.010	C, W, –, (R) ¹	
Description: 1 Bit object for activation or deactivation of the stair-case time of the stair-case function of an output (“1” = switch On / “0” = switch Off).						
Function: Stair-case function						
□↓ 15, 41, 67, 93, 119, 145, 171, 197 ³	Stair-case function, factor	Output 1 – 8 ³	1 Byte	5.010	C, W, –, (R) ¹	
Description: 1 Byte object for the time-factor of the stair-case time (range: 0 ... 255).						
Function: Scene function						
□↓ 16, 42, 68, 94, 120, 146, 172, 198 ³	Light scene extension	Output 1 – 8 ³	1 Byte	18.001	C, W, –, (R) ¹	
Description: 1 Byte object for calling up or storing of a scenario.						
Function: Acknowledge switching						
□↓ 18, 44, 70, 96, 122, 148, 174, 200 ³	Acknowledge switching	Output 1 – 8 ³	1 Bit	1.001	C, –, T, (R) ¹	
Description: 1 Bit object for the acknowledge of an output status (“1” = switch On / “0” = switch Off; note operation mode!).						
Function: Elapsed hour counter						
□↓ 19, 45, 71, 97, 123, 149, 175, 201 ³	Limiting value / Start value Elapsed hour counter ⁴	Output 1 – 8 ³	2 Byte	7.007	C, W, –, (R) ¹	
Description: 2 Byte object for external setting of a limiting value / start value of the elapsed hour counter of an output (range: 0 ... 65535).						
Function: Elapsed hour counter						
□↓ 20, 46, 72, 98, 124, 150, 176, 202 ³	Reset Elapsed hour counter	Output 1 – 8 ³	1 Bit	1.015	C, W, –, (R) ¹	
Description: 1 Bit object for resetting the elapsed hour counter of an output (“1” = reset, “0” = no reaction).						
Function: Elapsed hour counter						
□↓ 21, 47, 73, 99, 125, 151, 177, 203 ³	Value elapsed hour counter	Output 1 – 8 ³	2 Byte	7.007	C, W, –, (R) ¹	
Description: 2 Byte object for transmitting or read-out of the current meter reading of the elapsed hour counter. The value of the communication object will not be lost at bus voltage drop and will be send to the bus at bus voltage recovery or ETS-download.						
Function: Elapsed hour counter						
□↓ 22, 48, 74, 100, 126, 152, 178, 204 ³	Elapse elapsed hour counter	Output 1 – 8 ³	1 Bit	1.002	C, W, –, (R) ¹	
Description: 1 Bit object for the message that the elapsed hour counter is elapsed (up counter = limiting value reached / down counter = value “0” reached). With a message the object value will be send actively to the bus. (“1” = message active / “0” = message inactive). The value of the communication object will not be lost at bus voltage drop and will be send to the bus at bus voltage recovery of ETS-download.						

¹ Each communication object can be read out. Set “R” flag.

² Depending on the parameter, acknowledge objects are either active (T-Flag set) or passive, can be read out (set R-Flag).

³ Number of outputs or communication objects acc. to the chosen device (4-gang = 4 outputs or 8-gang = 8 outputs).

⁴ Limiting value object or start value object acc. to the chosen elapsed hour counter mode.

5 Description of software application

Superior channel functions

Delay after bus voltage recovery

In order to reduce the bus-traffic after bus-reset, connecting the devices to the bus or after ETS-download it is possible to delay all active sending acknowledges (ACK). A delay time can be adjusted.

The ACK to be delayed can be adjusted independently for each output and ACK-function.

Central function

All output channels can be linked by a 1-Bit central-communication object. The behaviour is assimilable with a central group address, linked to all switching objects.

Collective acknowledge

After central commands or bus voltage recovery the bus load is normally high as many devices send out an ACK about the status of its communication objects. This especially happens within visualisations. The collective ACK can be used to reduce the bus load.

In the collective ACK all switching status are combined in a 32 Bit communication object.

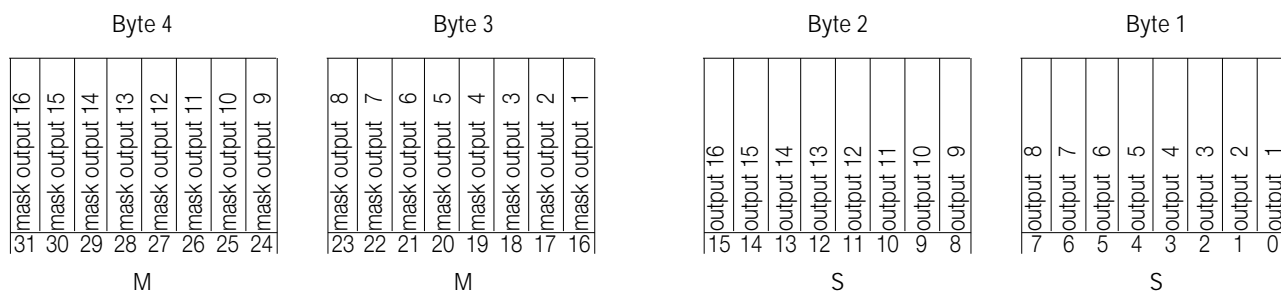

Structur of object Collective Acknowledge

The collective ACK can be used as an active object – will be send out with each change of a switching status – or as a passive status object – object value can be read out.

4-gang switch actuator 16A SE 8-gang switch actuator 16A SE

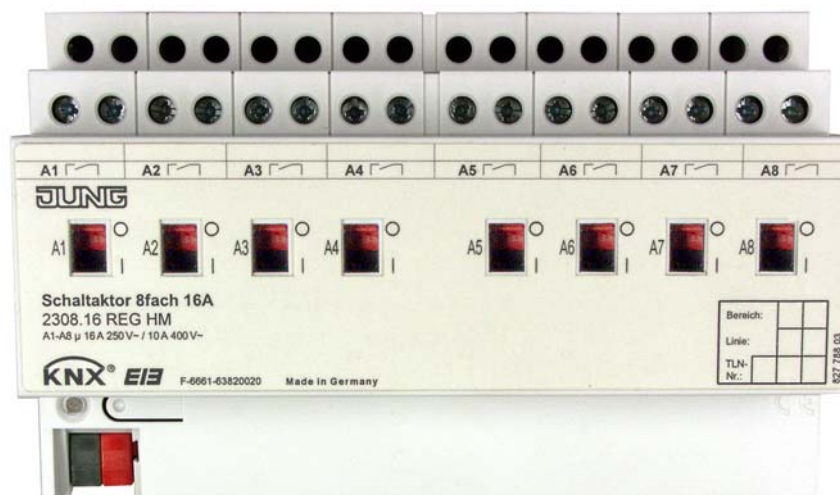

Date of issue: 27.07.2006
230x16.doc

Table of Contents

<u>1</u>	<u>Product definition</u>	<u>3</u>
1.1	Product catalogue	3
1.2	Function	3
<u>2</u>	<u>Fitting, electrical connection and operation</u>	<u>4</u>
2.1	Safety instructions	4
2.2	Device components	5
2.3	Fitting and electrical connection	6
2.4	Commissioning	7
2.5	Operation	8
<u>3</u>	<u>Technical data</u>	<u>9</u>
<u>4</u>	<u>Software information</u>	<u>11</u>
4.1	Software specifications	11
4.2	Software "Switching with ack., logic link, time func. 2088x1 / 2090x1"	12
4.2.1	Scope of functions	12
4.2.2	Software information	13
4.2.3	Object table	14
4.2.4	Functional description	18
4.2.4.1	Description of functions affecting several channels:	18
4.2.4.2	Channel-oriented functional description	22
4.2.4.3	Delivery state	51
4.2.5	Parameters	52

1 Product definition

1.1 Product catalogue

Product name: 4-gang switch actuator 16A SE / 8-gang switch actuator 16A SE
Use: actuator
Design: REG (rail-mounted device)
Order no.: 4-gang: 2304.16 REG HM / 8-gang: 2308.16 REG HM

1.2 Function

The switching actuator receives telegrams from sensors or other controls via the KNX / EIB and switches electrical consumers by means of its relay contacts which are independent of one another. Each switching output has a separate bistable switching relay so that the states of the switching contacts are safely maintained even in case of bus voltage failure.

With the slide switches on the device front panel, the relays can be switched on and off by hand parallel to the KNX / EIB even without bus voltage or in a non-programmed state. This feature permits fast checking of connected consumers for proper functioning.

The functionalities that can be programmed independently with the ETS for each output channel include among other things extensive timing functions, logic operations, scenes, disabling functions, operating hours counter, cyclical monitoring and an enlarged range of response telegrams. Centralized switching of all outputs is also available. Moreover, the preferred states of the relay contacts in case of bus voltage failure or bus voltage return and after ETS programming can be preset separately.

For project design and commissioning of this device it is recommended to use the ETS3.0d. The advantages with regard to downloading (shorter loading times) and parameter programming are available only if this new ETS patch version or later versions are used. For the ETS2 and older versions of the ETS3 a separate product database is available.

The switching actuator is supplied with power from the KNX / EIB and therefore does not need an additional external power supply. The device is designed for fitting on DIN rails in closed compact boxes or in power distributions in fixed installations in dry rooms.

2 Fitting, electrical connection and operation

2.1 Safety instructions

Electrical equipment must be installed and fitted only by qualified electricians. Observe the current accident prevention regulations.

Failure to observe any of the installation instructions may cause damage to the device and result in fire and other hazards.

Before working on the device or before replacing any connected loads, disconnect the supply voltage (by cutting out the circuit breaker) to avoid the risk of an electric shock.

The switching actuator is not suited for safe disconnection of the mains.

Do not connect mains voltage and SELV/PELV circuits to the same switching actuator.

Do not connect three-phase AC motors to the actuator.

Make sure during the installation that there is always sufficient insulation between the mains voltage and the bus. A minimum spacing of 4 mm must be ensured between bus wires and mains conductors.

Do not open the device and do not operate it outside the scope of the technical specifications.

2.2 Device components

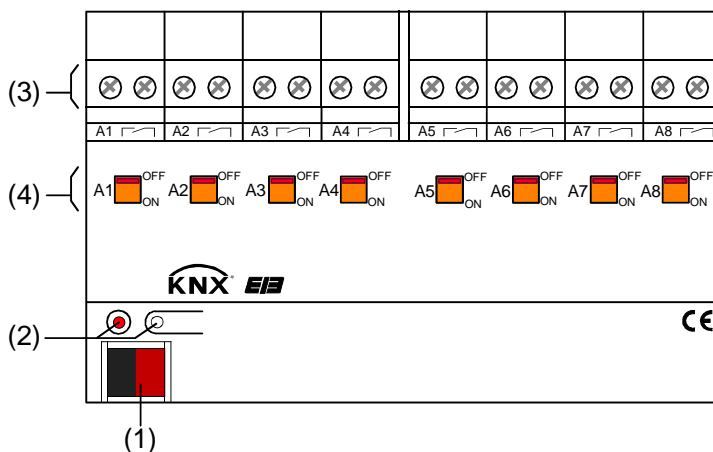
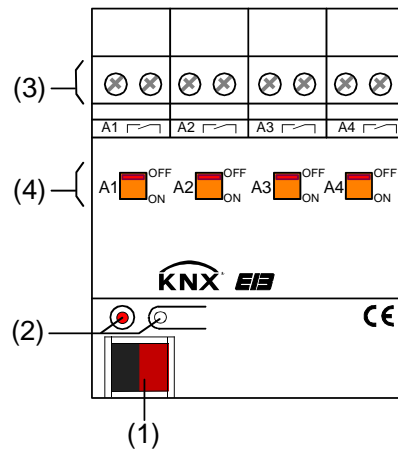

Dimensions:

width (W):
144 mm (8 MW)

height (H):
90 mm

depth (D):
70 mm

- (1): KNX/EIB bus connection
- (2): Programming button and programming LED (red). The programming LED flashes slowly when the safe-state mode is active.
- (3): Screw terminals (Ax, \curvearrowright) for connection of different loads (potential-free)
- (4): Slide switches for relay control and for indication of the switching states
Position 'OFF': contact open
Position 'ON': contact closed

2.3 Fitting and electrical connection



DANGER!

Electric shock in case of accidental contact with live parts. Electric shocks can be fatal. Before working on the device, cut out the mains supply and cover up live parts in the surroundings.

Fitting

- Fit the device by snapping it onto a mounting rail in acc. with DIN EN 60715. The screw terminals for connection of the load should be at the top.
- ⓘ A KNX / EIB data rail is not required.
- ⓘ Observe the temperature range (-5 °C ...+45 °C) and ensure sufficient cooling.

Connection

- Connect the loads and the bus line as shown in fig. 1 (connection example).

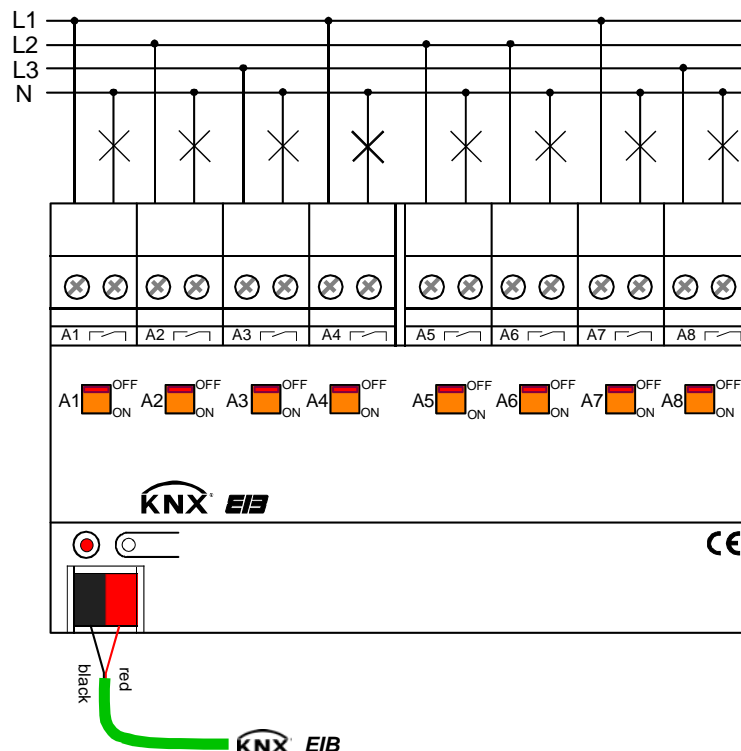

Fig. 1: Electrical connection

- ⓘ The relay output contacts of the switching actuator react at brief intervals when actuated or with a slight time delay when actuated by a central control telegram.
- ⓘ The device accepts different phase conductors (L1, L2, L3) at the outputs.
- ⓘ Do not connect three-phase AC motors to the actuator.

Installing / removing the protective cap

To protect the bus lines against hazardous voltages, especially in the area of the connecting terminals, a protective cap can be installed.

The bus must be connected with the bus line led out at the rear (bus terminal plugged into device).

- To install the cap: Slide the cap over the bus connecting terminal until it snaps in place (cf. Fig. 2-A).
- To remove the cap: Remove the cap by pressing the sides slightly and by pulling it out to the front (cf. Fig. 2-B).

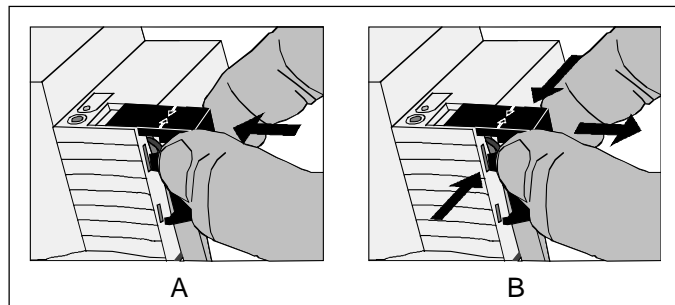

Fig. 2: Installing / removing the protective cap

2.4 Commissioning

After installation of the actuator and connection of the bus line and of all electrical loads, the device can be put into operation. The following procedure is generally recommended...



DANGER!

Electric shock in case of accidental contact with live parts. Electric shocks can be fatal. Before working on the device, cut out the mains supply and cover up live parts in the surroundings.

Putting the device into operation

All loads must have been completely installed and connected.

- Switch on the bus voltage Check: the red programming LED must light up when the programming button is being depressed.
 - Download the physical address and the application data with the ETS.
 - Switch on the mains voltage supply to the outputs.
 - The device is now ready for operation.
- i** The outputs of the actuator can be switched manually even without bus voltage and in the unprogrammed state of the actuator. Due to this feature, the loads connected to the individual outputs can be checked for proper functioning already during site operation.

2.5 Operation

The switching position of the relays is indicated by slide switches on the front panel of the device (cf. Fig. 3). The switches are also provided for manual operation and can be actuated with a suitable tool (e.g. screwdriver).

Manual operation of an output

- Slide the switch into the 'OFF' position
The relay contact is open.

- Slide the switch into the 'ON' position
The relay contact is closed.

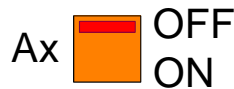

Fig. 3: Slide switch for each output with indication of switching position

- ❗ The position of the slide switch shows directly the switching state of the relay independently of the mode of operation of the output (programming as make or break contact).
- ❗ Manual switching of the relays is independent of the bus. In case of manual switching there will be no feedback via the bus.
- ❗ Manual operation of the slide switches does not inhibit operation via the bus. An output last operated by hand can at any time be controlled via the bus.
- ❗ An output disabled via the bus can nevertheless be operated by hand!

3 Technical data

Type of protection	IP 20
Safety class:	III
Mark of approval:	KNX / EIB / VDE
Ambient temperature:	-5 °C ...+45 °C
Storage / transport temperature:	-25 °C...+70 °C (Storage above + 45 °C reduces the lifetime)
Mounting position:	any position (preferred: output terminals at the top)
Minimum distances:	none
Type of fastening:	Snap-fastening on DIN rail in closed cabinets (e.g. small distributions, etc.) / KNX / EIB data rail not required.
KNX / EIB supply	
Voltage:	21...32 V DC SELV
Power consumption:	typically 150 mW
Connection:	with screw terminals: 0,5...4 mm ² solid and stranded wire without ferrule 0,5...2,5mm ² stranded wire with ferrule Max. tightening torque: 0.8 Nm
External supply	---
Total power loss:	4-channel switching actuator: max. 4 W 8-channel switching actuator: max. 8 W
Response to bus voltage failure:	depending on parameterization cf. chapter 4. "Software description")
Response to bus voltage return:	depending on parameterization cf. chapter 4. "Software description")
Output:	
Number:	8
Type of contact:	potential-free μ -contact, bistable
Switching voltage:	230 V AC; 50 / 60 Hz 400 V AC; 50 / 60 Hz 24 V DC
Switching capacity 230 V AC	16 A / AC 1 10 A / AC 3
Switching capacity 400 V AC	10 A / AC 1 6 A / AC 3
Switching capacity DC	16 A / 24 V (resistive load)
max. Inrush current:	400 A, 150 μ s 200 A, 600 μ s
min. switching current:	100 mA (at 24 V)

Technical data (continued)

Output:

Number:	4-channel switching actuator: 4 8-channel switching actuator: 8
Connection:	with screw terminals: 0.5...4 mm ² solid and stranded wire without ferrule 0.5...2.5 mm ² stranded wire with ferrule Max. tightening torque: 0.8 Nm

Switching capacity:

Resistive load	3600 W
Capacitive load:	10 A max. 140 µF

Lamp loads:

Incandescent lamps:	2500 W
HV halogen:	2500 W
LV halogen:	
conventional transformers:	1200 VA
Tronic transformers:	1500 W
Fluorescent lamps T5 / T8	
non-compensated	2500 W
parallel compensated:	1300 W, 140 µF
Lead-lag circuit:	2300 W, 140 µF

Compact fluorescent lamps:

non-compensated:	2500 W
parallel compensated:	1300 W, 140 µF

Mercury vapour lamps:

non-compensated:	2000 W
parallel compensated:	2000 W, 140 µF

ELECTRONIC BALLASTS

The number of electronic ballasts that can be connected to the device depends on type and make of the ballast and additionally also on the condition of the low-voltage mains supply network. For this reason, different electronic ballasts are listed below as an example (manufacturer: Osram).
max. number per output:

T8 lamps:

QTP 3 x 18 W, 4 x 18 W	17
QTP 2 x 36 W	17
QTP 1 x 58 W	17
QTP 2 x 58 W	11

T5 lamps:

QT-FH 1 x 28 W	17
QT-FH 2 x 28 W	17
QT-FQ 2 x 54 W	11
QT-FQ 1 x 80 W	11

4 Software information

4.1 Software specifications

ETS search paths: - Output / Binary output, 4-gang /4-gang switch actuator 16A SE
 - Output / Binary output, 8-gang /8-gang switch actuator 16A SE

BAU used: ASIC 1066 + μ C

KNX/EIB type class: 3b - Dev. with cert. PhL + stack

Configuration: S-mode standard

PEI type: "00"_{Hex} / "0"_{Dec}

PEI connector: no connector

Applications for 4-channel switching actuator REG

No.	Summarized description:	Name	Version:	Executable from mask version:
1	Multi-function 4-channel switching with timing functions, logic operations, scenes, disabling functions, operating hours counter, cyclical monitoring and an enlarged set of response telegrams. Centralized switching of all outputs is also available. Moreover, the preferred states of the relays in case of bus voltage failure or bus voltage return and after ETS programming can be preset separately.	Switching with ack., logic link, time func. 209001	0.1 for ETS 2 and ETS 3a...c	705
		Switching with ack., logic link, time func. 209011	1.1 for ETS3 from version d onwards	

Applications for 8-channel switching actuator REG

No.	Summarized description:	Name	Version:	Executable from mask version:
1	Multi-function 8-channel switching with timing functions, logic operations, scenes, disabling functions, operating hours counter, cyclical monitoring and an enlarged set of response telegrams. Centralized switching of all outputs is also available. Moreover, the preferred states of the relay contacts in case of bus voltage failure or bus voltage return and after ETS programming can be preset separately.	Switching with ack., logic link, time func. 208801	0.1 for ETS 2 and ETS 3a...c	705
		Switching with ack., logic link, time func. 208811	1.1 for ETS3 from version d onwards	

4.2 Software "Switching with ack., logic link, time func. 2088x1 / 2090x1"

4.2.1 Scope of functions

- Each output offers the full scope of functions without any restrictions. All channel-oriented functions can be parameterized separately for each output. This feature permits independent and multi-functional control of the switching outputs.
- Bus-independent manual switching of relays / switching position indication.
- Operation as break or make contacts.
- Central switching function with centralized feedback.
- Switching feedback mode (only with bus operation): active (after changes or cyclical transmission to the bus) or passive (object readout function) feedback function.
- Logic function individual for each output.
- Disabling function parameterizable for each channel. Forced-control position function separately for each output as an alternative.
- Timing functions (ON-delay, OFF-delay, staircase lighting timer, also with early-warning function)
- Incorporation into light-scenes: up to 8 internal scenes parameterizable per output.
- Operating hours counter can be activated independently for each output.
- Input monitoring for cyclical updates with safety circuit.
- Behaviour in case of bus voltage failure and bus voltage return as well as after ETS programming presettable for each output.

4.2.2 Software information

ETS project design and commissioning

For project design and commissioning of this device it is recommended to use the ETS3.0d. Advantages with regard to downloading (significantly shorter loading times) and parameter programming can be expected only if this ETS patch version or later versions are used. The advantages consist in using the new mask version 7.5 and the parameter presentation of the ETS3.

The product database required for the ETS3.0d is offered in the *.VD4 format. The corresponding application program is version number "1.1". For the ETS2 and older versions of the ETS3 a separate product database in the *.VD2 format is available. The application program for this ETS version is number "0.1".

As far as the programming scope of functions described in this documentation is concerned, there is no difference between the two application programs.

When older ETS versions are updated to the level of version ETS3.0d or to that of later versions, an additional tool in the form of an ETS add-in is available. This tool is capable of converting older product databases of application version "0.1", for instance from existing ETS2 projects, into the new application format (version "1.1"). This feature permits making use of the advantages of the ETS3.0d application in an easy way and without any changes. The ETS3 add-in can be obtained separately from the manufacturer and is free of charge.

Safe-state mode

If the device - for instance as a result of errors in the project design or during commissioning - does not work properly, the execution of the loaded application program can be halted by activating the safe-state mode. In the safe-state mode, the outputs cannot be controlled via the bus. The actuator remains passive since the application program is not being executed (state-of-execution: terminated). Only the system software is still functional so that the ETS diagnosis functions and also the programming of the device continue to be visible.

Activation of the safe-state mode

The bus voltage is not yet connected.

- Press the programming button and keep it pressed.
- Switch on the bus or mains voltage. Release the programming button only after the programming LED starts flashing slowly.

The safe-state mode is activated. With a new brief press on the programming button, the programming mode can be switched on and off as usual also in the safe-state mode. The programming LED will nevertheless continue to flash independently of the programming mode as long as the safe-state mode is active.

i The safe-state mode can be terminated by switching off the bus voltage or by programming with the ETS.

4.2.3 Object table

Number of communication objects:	4-channel: 50 (max. object number 100 – gaps in between) 8-channel: 98 (max. object number 204 – gaps in between)
Number of addresses (max):	254
Number of assignments (max):	255
Dynamic table management	no
Maximum table length	255

Objects affecting several channels:

Function: Central function

Object	Function	Name	Type	DP type	Flag
 8	Central switching function	All switching outputs	1 bit	1.001	C, W, -, (R) ¹

Description: 1-bit object for central switching of switching outputs assigned. The polarity can be parameterized.

Function: Centralized feedback

Object	Function	Name	Type	DP type	Flag
 9	Centralized feedback	All switching outputs	4 bytes	27.001	C, -, T, R ²

Description: 4-byte object for centralized feedback of all of the actuators switching states.

¹ Every communication object can be read out. For readout, the R-flag must be set.

² Depending on parameterization, feedback objects are either actively transmitting (C-flag set) or passively readable (R-flag set).

Channel-oriented objects:

Function: Output switching

Object	Function	Name	Type	DP type	Flag
<input type="checkbox"/> 10, 36, 62, 88, 114, 140, 166, 192 ³	Switching	Output 1 – 8 ³	1 bit	1.001	C, W, -, (R) ¹

Description: 1-bit object for controlling one output ("1" = on / "0" = off; observe the parameterized operating mode!).

Function: Forced-control position

Object	Function	Name	Type	DP type	Flag
<input type="checkbox"/> 11, 37, 63, 89, 115, 141, 167, 193 ³	Forced-control position	Output 1 – 8 ³	2 bit	2.001	C, W, -, (R) ¹

Description: 2-bit object for forced control of an output. The object state after bus voltage return can be predefined by parameters.

Function: Disabling function

Object	Function	Name	Type	DP type	Flag
<input type="checkbox"/> 12, 38, 64, 90, 116, 142, 168, 194 ³	Disabling	Output 1 – 8 ³	1 bit	1.003	C,W, -, (R) ¹

Description: 1-bit object for disabling of an output (polarity parameterizable).

Function: Logic operation

Object	Function	Name	Type	DP type	Flag
<input type="checkbox"/> 13, 39, 65, 91, 117, 143, 169, 195 ³	Logic operation	Output 1 – 8 ³	1 bit	1.002	C, W, -, (R) ¹

Description: 1-bit object for the input of the logic operation of an output. The object value after bus voltage return or after programming with the ETS can be predefined with parameters.

³ The number of outputs of the communication objects depends on the programmed device (switching actuator 4-channel = 4 outputs or switching actuator 8-channel = 8 outputs).

¹ Every communication object can be read out. For readout, the R-flag must be set.

Function: Staircase function

Object	Function	Name	Type	DP type	Flag
 14, 40, 66, 92, 118, 144, 170, 196 ³	Staircase function start/stop	Output 1 – 8 ³	1 Bit	1.010	C,W, -, (R) ¹

Description: 1-bit object for activation or deactivation of the time delay of the staircase function of an output ("1" = on / "0" = off).

Function: Staircase function

Object	Function	Name	Type	DP type	Flag
 15, 41, 67, 93, 119, 145, 171, 197 ³	Staircase function factor	Output 1 – 8 ³	1 byte	5.010	C,W, -, (R) ¹

Description: 1-byte object for setting the time factor for the lighting time of the staircase timer function (value range: 0 ... 255).

Function: Scene function

Object	Function	Name	Type	DP type	Flag
 16, 42, 68, 94, 120, 146, 172, 198 ³	Scene extension	Output 1 – 8 ³	1 byte	18.001	C,W, -, (R) ¹

Description: 1-byte object for recalling scenes or for storing new scene values.

Function: Switching status feedback

Object	Function	Name	Type	DP type	Flag
 18, 44, 70, 96, 122, 148, 174, 200 ³	Switching feedback	Output 1 – 8 ³	1 bit	1.001	C, -, T, R ²

Description: 1-bit object for feedback signalling of the switching state of an output ("1" = on / "0" = off; observe the parameterized mode of operation!)

³ The number of outputs of the communication objects depends on the programmed device (switching actuator 4-channel = 4 outputs or switching actuator 8-channel = 8 outputs).

¹ Each communication object can be read out. For readout, the R-flag must be set.

² Depending on parameterization, feedback objects are either actively transmitting (C-flag set) or passively readable (R-flag set).

Function: Operating hours counter

Object	Function	Name	Type	DP type	Flag
<input type="checkbox"/> 19, 45, 71, 97, 123, 149, 175, 201 ³	Limit value / start value operating hours counter ⁴	Output 1 – 8 ³	2 bytes	7.007	C, W, -, (R) ¹

Description: 2-byte object for external preset of a limit value / start value for the operating hours counter of an output (value range: 0 ... 65535).

Function: Operating hours counter

Object	Function	Name	Type	DP type	Flag
<input type="checkbox"/> 20, 46, 72, 98, 124, 150, 176, 202 ³	New start operating hours counter	Output 1 – 8 ³	1 bit	1.015	C, W, -, (R) ¹

Description: 1-bit object for resetting the operating hours counter of an output ("1" = reset, "0" = no reaction).

Function: Operating hours counter

Object	Function	Name	Type	DP type	Flag
<input type="checkbox"/> 21, 47, 73, 99, 125, 151, 177, 203 ³	Value operating hours counter	Output 1 – 8 ³	2 bytes	7.007	C, -, T, (R) ¹

Description: 2-byte object for transmission or readout of the current count of the operating hours counter. The value of the communication object is not lost after a bus voltage failure and is actively transmitted the bus after bus voltage return or after programming with the ETS. As delivered, this value is "0".

Function: Operating hours counter

Object	Function	Name	Type	DP type	Flag
<input type="checkbox"/> 22, 48, 74, 100, 126, 152, 178, 204 ³	Runout operating hours counter	Output 1 – 8 ³	1 bit	1.002	C, -, T, (R) ¹

Description: 1-bit object for signalling that the operating hours counter has run out (up-counter = limit value reached / down-counter = value "0" reached). In case of signalling, the object value is transmitted to the bus ("1" = message active / "0" = message inactive). The value of the communication object is not lost after a bus voltage failure and is actively transmitted the bus after bus voltage return or after programming with the ETS when the message is active. If not, only the object will be initialized.

⁴ Limit value object or start value object depending on type of counter programmed as operating hours counter.

³ The number of outputs of the communication objects depends on the programmed device (switching actuator 4-channel = 4 outputs or switching actuator 8-channel = 8 outputs).

¹ Each communication object can be read out. For readout, the R-flag must be set.

4.2.4 Functional description

4.2.4.1 Description of functions affecting several channels:

Delay after bus voltage return

To reduce telegram traffic on the bus line after bus voltage activation (bus reset), after connection of the device to the bus line or after programming with the ETS, it is possible to delay all actively transmitted feedback telegrams of the actuator. For this purpose, a delay affecting several channels can be specified (parameter "Delay after bus voltage return" on parameter page "General". Feedback telegrams for bus initialization will therefore be transmitted to the bus only after the parameterized time has elapsed.

Which of the feedback telegrams is actually delayed and which is not can be specified for each output channel and for each feedback function separately.

- ❏ The delay has no effect on the behaviour of the outputs. Only the feedback telegrams are delayed. The outputs can also be activated during the delay after bus voltage return.
- ❏ Moreover, all actively transmitting objects of the operating hours counter are to be handled as feedback objects as well. In this case, however, all feedback telegrams are always transmitted with a delay depending on the parameter selected under "Delay after bus voltage return".
- ❏ A setting of "0" for the delay after bus voltage return deactivates the delaying function altogether. In this case, all feedback telegrams, if actively transmitted, will be transmitted to the bus without any delay.

Central function

The actuator offers the possibility of linking selected individual or all output channels with a 1-bit central communication object. The behaviour in case of activating an output via the central function is comparable to a central group address linked with all "Switching" objects.

The outputs assigned to the central function are activated in accordance with the central object value received. The polarity of the central telegram can, if necessary, be inverted by means of a parameter.

The behaviour of the channels is identical with 'normal' activation via the "Switching" objects (same priority – last switching command is executed – cf. Fig. 4). In this way, all 'secondary' functions such as timing or supplementary functions or logic operations are included as well. The parameterized relay operation is also evaluated for each output separately.

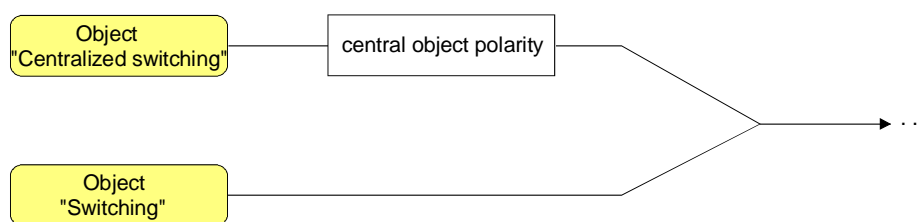

Fig.4: Functional diagram "Centralized switching"

Enabling the central function

- Enable the central function on parameter page "General" by setting the "Central function?" parameter to "Yes".

When the function is activated, the "Centralized switching" communication object is visible.

Assigning outputs to the central function

Each output can be assigned independently to the central function.

The central function must have been enabled on parameter page "General". The assignment has otherwise no effect on the switching output.

- Set the "Assignment to central function" parameter on the "Ax-General" page (x = number of output) to "Yes".

The corresponding output is now assigned to the central function. It can be switched on or off from a central control station.

- ❗ The switching state set by the central function is tracked in the feedback objects and also transmitted to the bus, if they are actively transmitting. The switching state set by a central function is not tracked in the "Switching" objects.
- ❗ After a bus voltage return or after programming with the ETS, the central function is always inactive (object value "0").

Centralized feedback

After central commands or after bus voltage return, a bus line is generally heavily loaded by data traffic as many bus devices are transmitting the state of their communication objects by means of feedback telegrams. This effect is particularly remarkable when visualizations are used. To keep the telegram load low during a 'bus initialization', the centralized feedback function of the actuator can be employed. The centralized feedback function groups the switching states of all outputs together in only one telegram. The 32-bit wide communication object "Centralized feedback" contains the feedback information of the individual outputs in a bit-oriented format and is organized as shown Fig. 5.

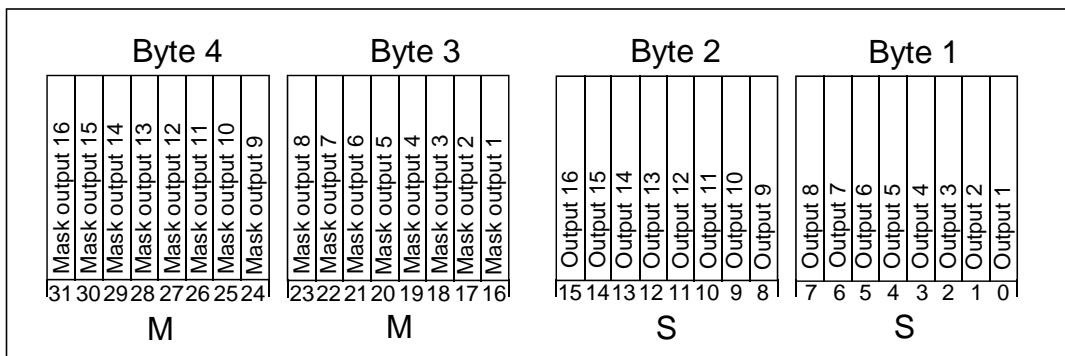

Fig. 5: Structure of the centralized feedback object

The object permits representing up to 16 outputs and thus up to 16 different switching states in a logical format, with each output having one bit representing the switching state ("S" bit) and another one defining the masking ("M" bit). The "S" bits correspond to the logical non-inverted switching states of the outputs and are either "1" (on) or "0" (off). The "M" bits are "1", if there is such an output on the actuator. Likewise, the "M" bits are "0", if there is no corresponding output on the actuator. In the latter case, the pertaining "S" bits are permanently "0" because there is no switching state.

Object value format for 4-channel switching actuator: "00 0F 00 0x", x = switching states,
Object value format for 8-channel switching actuator: "00 FF 00 xx", xx = switching states.

The datapoint type of the centralized feedback is KNX-standardized (DPT 27.001). It could be used in suitable visualization applications, for instance in public buildings like schools or hospitals, where the switching states of all actuators are displayed centrally and not separately at the local control units. In such applications, the centralized feedback can replace the 1-bit single feedback and thus reduce the bus load significantly.

Activating the centralized feedback function

The centralized feedback can be used as an active message object or as a passive status object. As an active message object, the centralized feedback information is transmitted to the bus whenever a switching state changes. On the other hand, no telegram will be transmitted when it is used as a passive status object. In this case, the object value must be read out. The ETS automatically sets the object communication flags required for proper functioning.

- The parameter "Make use of centralized feedback ?" of the required function must be set to "Yes, active message object" or "Yes, passive status object".
The 4-byte communication object "Centralized feedback" is enabled. The object can be used when it has been linked with a group address.

Activating centralized feedback on bus voltage return or after ETS programming

The centralized feedback state is transmitted to the bus after bus voltage return or ETS programming if used as active message object. In this case, the feedback can be delayed with the delay being set globally for all outputs together (cf. "Delay after bus voltage return").

- Set the parameter "Time delay for feedback telegram after bus voltage return" of the centralized feedback to "Yes".
The centralized feedback is transmitted with a delay after bus voltage return or ETS programming. No feedback telegram is transmitted during a running delay, even if a switching state changes during this delay.
- Set the parameter "Time delay for feedback telegram after bus voltage return" of the centralized feedback to "No".
The feedback telegram is transmitted immediately after bus voltage return or ETS programming.

Activating cyclical transmission for centralized feedback telegrams

By means of the actively transmitting signalling object, the centralized feedback telegram can – besides being sent in case of state changes – also be transmitted cyclically.

- Set the parameter "Cyclical transmission of centralized feedback telegram ?" on parameter page "General" to "Yes".
Cyclical transmission is now activated.
 - Set the parameter "Cyclical transmission of centralized feedback telegram ?" on parameter page "General" to "No".
Cyclical transmission is deactivated so that the centralized feedback is transmitted to the bus only when one of the switching states changes.
- i** The cycle time is defined centrally for all cyclical feedback telegrams on the parameter page "Time settings".
- i** No centralized feedback telegram is transmitted during an active delay after bus voltage return, even if a switching state changes during the delay.
- i** A blinking 'output' (cf. "disabling function") will always be reported back as "switched on".
- i** Changes of the switching state made manually are not detected.

4.2.4.2 Channel-oriented functional description

Mode of operation

The relays of a switching output can be parameterized as make or break contacts. This feature offers the possibility of inversion the switching states. The preset mode of operation has consequences for the switching state feedback function.

Setting the mode of operation

The parameter "Mode of operation" exists separately for each output channel on the parameter page "Ax - General" (x = number of output).

- Program the relay contact as "make contact".
Switching state = off ("0") → relay contact open,
Switching state = on ("1") → relay contact closed.
- Program the relay contact as "break contact".
Switching state = off ("0") → relay contact closed,
Switching state = on ("1") → relay contact open.

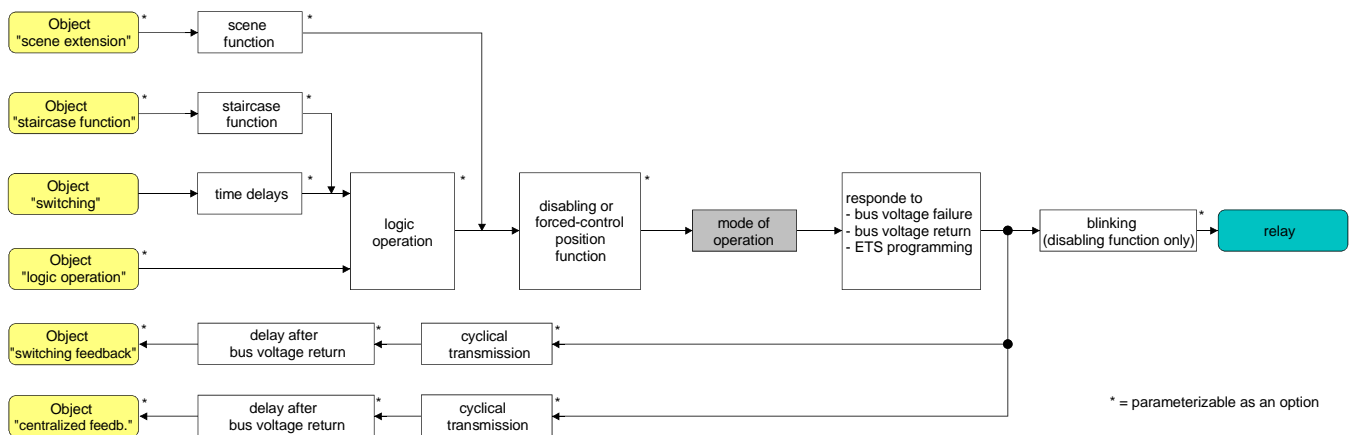

Fig. 6: Functional diagram "Mode of operation"

- ❗ The logic switching state ("on - 1" or "off - 0") is set by the communication object "Switching" and influenced by the functions that can be optionally activated (e.g. timing/staircase functions, logic operations, disabling/forced-control position functions, scenes – cf. Fig. 6).
- ❗ A switching state set after bus voltage return or after ETS programming will be tracked in the feedback object depending on the "Mode of operation" parameter.

Reaction after bus voltage failure / return or after ETS programming

The preferred relay contact positions after bus voltage return or after ETS programming can be preset separately for each output. Since the actuator is equipped with bistable relays, the relay switching state at bus voltage failure can be defined as well.

Presetting the Behaviour after ETS programming

The parameter "Behaviour after ETS programming" can be preset separately for each output channel on the parameter page "Ax - General" (x = number of output). This parameter can be used to parameterize the output relay behaviour independent of the behaviour after bus voltage return.

- Set the parameter to "no reaction".
After ETS programming, the relay of the output shows no response and remains in the switching state last selected. The internal logic switching state is not lost either by an ETS programming cycle.
 - Set the parameter to "close contact".
The relay contact is closed after an ETS programming cycle.
 - Set the parameter to "open contact".
The relay contact is opened after an ETS programming cycle.
- i** The parameterized behaviour will be executed after every application or parameter download by the ETS. Downloading only the physical address or programming the group addresses only partially has the effect that this parameter will be disregarded and the parameterized "Behaviour after bus voltage return" be adopted.
- i** A switching state set after an ETS programming cycle will be tracked in the feedback object depending on the "Mode of operation" parameter.

Presetting the behaviour in case of bus voltage failure

The parameter "Behaviour in case of bus voltage failure" can be preset separately for each output channel under "Ax - General" (X = number of output).

- Set the parameter to "no reaction".
In case of bus voltage failure, the relay of the output shows no reaction and remains in the switching state last selected.
- Set the parameter to "close contact".
The relay contact is closed on bus voltage failure.
- Set the parameter to "open contact".
The relay contact is opened on bus voltage failure.

Presetting the reaction after bus voltage return

The parameter "Behaviour after bus voltage return" can be preset separately for each output channel on parameter page "Ax - General" (x = number of output).

- Set the parameter to "close contact".
The relay contact is closed after bus voltage return.
 - Set the parameter to "open contact".
The relay contact is opened after bus voltage return.
 - Set the parameter to "State as before bus voltage failure".
After bus voltage return, the switching state last selected before bus voltage failure and internally stored on bus voltage failure will be tracked.
 - Set the parameter to "no reaction".
After bus voltage return, the relay of the output shows no reaction and remains in the switching state last selected.
 - Set the parameter to "Activate staircase function (if parameterized)".
The staircase function is activated after bus voltage return independent of the "Switching" object. For this setting it is indispensable that the staircase function has been programmed and enabled beforehand. When the staircase function has not been enabled, this setting will produce no reaction after bus voltage return.
- ❗ "No reaction" setting: On return of bus voltage, the switching state will be internally set back to "switched off - 0" independent of the position of the relay contacts. The feedbacks will also be initialized this way, if applicable even in inverted form.
In this case, the switching status returned corresponds to the 'true' relay status only after the outputs have been activated at least once via the bus.
- ❗ The actuator takes its power supply completely from the bus and switches the output relays only after a sufficient amount of energy has been stored. For this reason, there may be a brief delay after a bus voltage return (5 s max.) before the device adopts the parameterized behaviour.
- ❗ The device adopts the parameterized behaviour only if the last ETS programming of the application or of the parameters occurred at least ca. 20 s ago. Otherwise ($T_{ETS} < 20$ s), the "Behaviour after ETS programming" will be adopted even after a return of the bus voltage.
- ❗ The parameterized behaviour will only be adopted, if no forced control is activated after a bus voltage return.
- ❗ A switching state set after a bus voltage return will be tracked in the feedback object depending on the "Mode of operation" parameter.

Switching status feedback

The actuator can return the switching status set at its output ("on" or "off") to the bus (cf. Fig. 7). The returned feedback value can optionally be inverted.

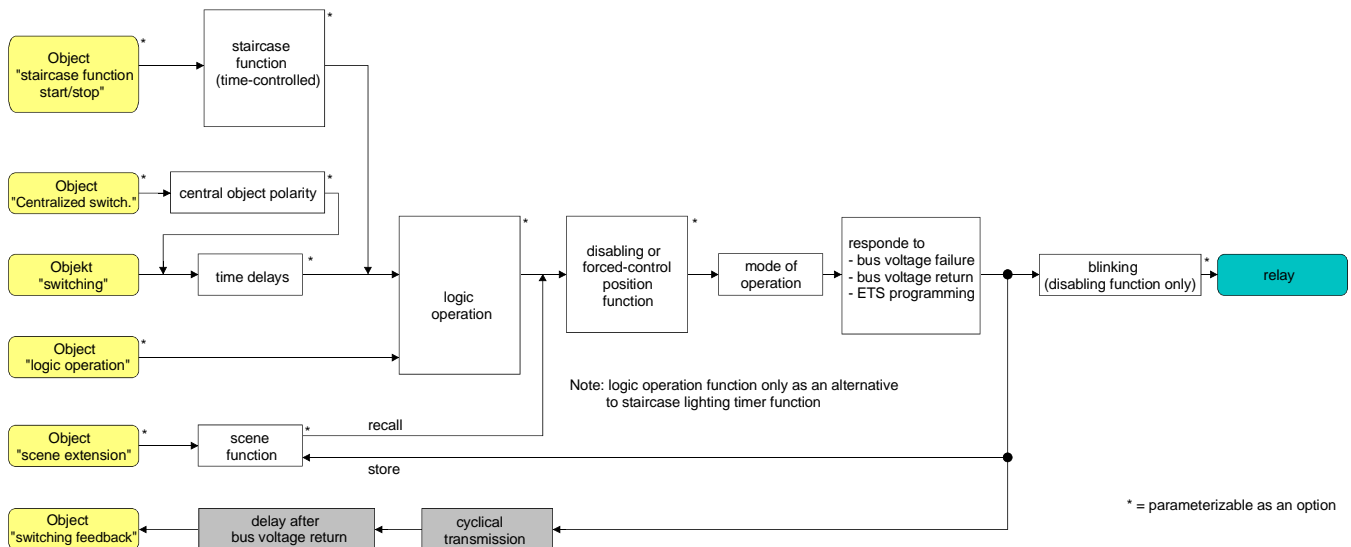

Fig. 7: Functional feedback diagram

Activating the switching status feedback function

The switching status feedback can be used as an active message object or as a passive status object. As an active message object, the switching status feedback information is transmitted to the bus whenever a switching state changes. As a passive status object, there is no telegram transmission after a change. In this case, the object value must be read out. The ETS automatically sets the object communication flags required for proper functioning.

The parameter "Feedback telegram?" can be preset separately for each output channel on the parameter page "Ax - General" (x = number of output).

- Set the parameter to "no inversion, active message object" or to "inversion, active message object".
The feedback object is enabled. Depending on the setting, the switching status is transmitted in non-inverted or in inverted form as soon as a change of state occurs or after the device has been programmed with the ETS. The transmission of telegrams takes place even after return of the bus voltage.
 - Set the parameter to "no inversion, passive status object" or to "inversion, passive status object".
The feedback object is enabled. Depending on the setting, the switching status will be transmitted back in inverted or non-inverted form only if the feedback object is read by the bus. No automatic telegram transmission takes place after bus voltage return or after programming with the ETS.
- i** In case of actively transmitting objects, all status updates from "ON" to "ON" or from "OFF" to "OFF" via the object "Switching" or the object "Central switching" always cause a feedback telegram to be transmitted. If a delay is preset and if the switching state is changed via the object "Switching", the delay period must have elapsed before the feedback will be updated.

- ❗ A 'blinking' output (cf. "Disabling function") will always be reported back as "switched on".
- ❗ Switching state changes by manual operation are not detected.

Activating switching status feedback on return of bus voltage or after programming with the ETS

If used as active message object, the switching status feedback information is transmitted to the bus after bus voltage return or after programming with the ETS. In these cases, the feedback telegram can be time-delayed with the delay being preset globally for all outputs together (cf. "Delay after bus voltage return").

- Set the parameter "Time delay for feedback telegram delay after bus voltage return" on parameter page "Ax - General" (x = number of output) to "Yes".

The switching status telegram will be transmitted with a delay after bus voltage return or after programming with the ETS. No feedback telegram is transmitted during a running delay, even if a switching state changes during this delay.

- Set the parameter "Time delay for feedback telegram delay after bus voltage return" on parameter page "Ax - General" (x = number of output) to "No".

The switching status telegram will be transmitted immediately after bus voltage return or after programming with the ETS.

- ❗ In case of a feedback telegram after bus voltage return or after programming with the ETS, the parameterized mode of operation will be evaluated. Examples for a non-inverted switching status feedback telegram:

Mode of operation make contact: contact closed = feedback "on",
Mode of operation make contact: contact opened = feedback "off",
Mode of operation break contact: contact closed = feedback "off",
Mode of operation break contact: contact opened = feedback "on".

Presetting the cyclical transmission function for the switching status feedback telegram

In addition to being transmitted in case of a state change, the switching status feedback telegram can also be transmitted cyclically via the active message object.

- Set the parameter "Cyclical transmission of feedback telegram?" on parameter page "Ax - General" (x = number of output) to "Yes".

Cyclical transmission is now activated.

- Set the parameter "Cyclical transmission of feedback telegram?" on parameter page "Ax - General" (x = number of output) to "No".

Cyclical transmission is deactivated which means that a feedback telegram is transmitted to the bus only if one of the switching states changes.

- ❗ The cycle time is defined centrally for all cyclical feedback telegrams on the parameter page "Time settings"
- ❗ During an active delay after bus voltage return no feedback telegram will be transmitted even if a switching state changes.

Cyclical monitoring

The actuator offers the possibility of monitoring specific outputs or all outputs for the arrival of switching telegrams. This feature can be used to monitor such objects that have to be updated cyclically by the bus, for instance, by means of actuating variable telegrams from room temperature controllers. The polarity of the telegram update ("0" or "1") is of no importance in this case.

If the monitored objects are not updated within a fixed parameterized monitoring period, the outputs concerned will adopt their predefined preferred state. This does not mean, however, that the outputs are disabled, but rather that they will be set to the new switching state after reception of another switching telegram.

The monitoring time is preset globally for all outputs together with the "Time for cyclical monitoring" parameter on the "Time settings" parameter page. Each output has its own time control so that the parameterized monitoring time will be evaluated independent of the channel.

The time is restarted for an output (cf. Fig. 8) after each reception of a switching telegram via the objects "Switching" or "Central switching" (if a central function has been activated for the output concerned). The monitoring time is restarted automatically also after bus voltage return or after programming with the ETS.

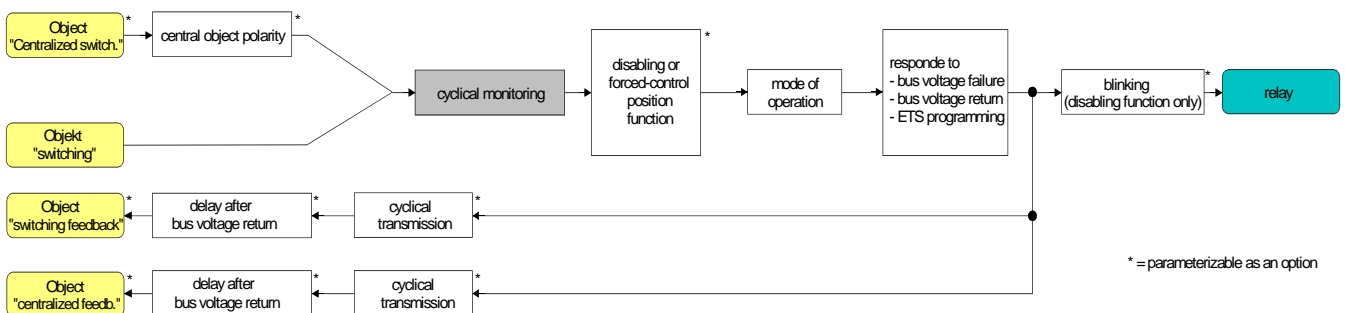

Fig. 8: Functional diagram of cyclical monitoring function

Activating the cyclical monitoring function

The cyclical monitoring function can be activated separately for each output with the parameter "Assignment to cyclical monitoring ?" on parameter page "Ax – Enabled functions" (x = number of output). When the monitoring time elapses without receiving a telegram update while the function is active, the actuator sets the output to the preferred state when the time ends.

- Set the parameter to "Yes, "ON" when time has elapsed".
The cyclical monitoring function is now activated. The output will be switched on at the end of the time.
- Set the parameter to "Yes, "OFF" when time has elapsed".
The cyclical monitoring function is now activated. The output will be switched off at the end of the time.

- ⓘ When the cyclical monitoring function is active, the following functions cannot be parameterized: time delays, staircase function, logical operation and scene.
- ⓘ If an output is already in its preferred state when the monitoring time elapses, there will be no reaction and no transmission of a feedback telegram.
- ⓘ The disabling or forced-control position function has a higher priority than the cyclical monitoring function.

Time delays

Up to two time functions can be preset independently for each output. The time functions act only on the communication objects "Switching" or "Central switching" (if a central has been activated for the output in question) and delay the received object value as a function of telegram polarity (cf. Fig. 9).

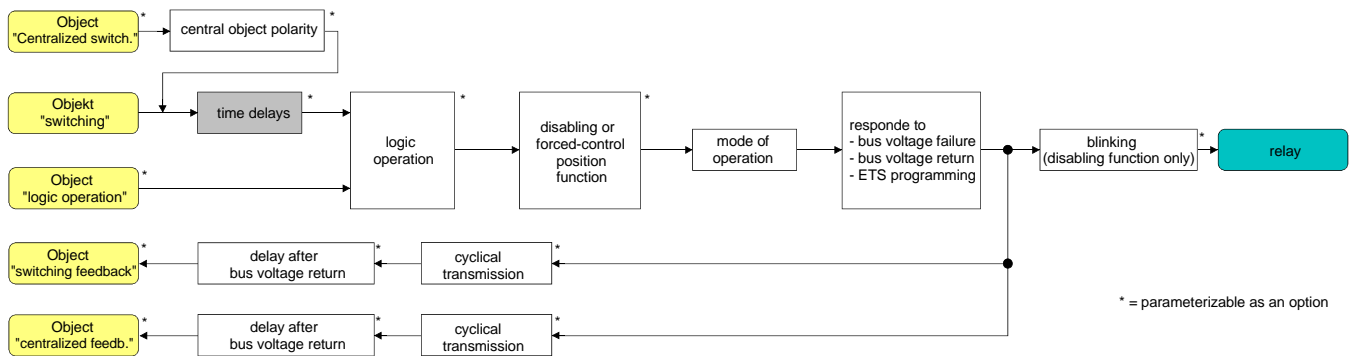

Fig.9: Functional diagram of the time delays

Activating an ON-delay

The time delays must have been enabled on parameter page "Ax – Enabled functions (x = number of output).

- Set the parameter "Selection of time delay" on parameter page "Ax – Time delays" to "ON-delay" or to "ON-delay and OFF delay".

The ON-delay is now enabled and the desired ON-delay time can be preset. After reception of an ON telegram, a parameterized time is started. A subsequent ON-telegram retriggers the time only if the parameter "ON-delay retriggerable ?" has been set to "Yes". The logical switching state will then be transferred to the following functions (e.g. logical operation, disabling / forced-control position function) and the output switched on, only after the ON-delay has elapsed. An OFF-telegram received during the ON-delay will end the delay. The logical switching state corresponds in this case to "switched off".

Activating an OFF-delay

The time delays must have been enabled on parameter page "Ax – Enabled functions (x = number of output).

- Set the parameter "Selection of time delay" on parameter page "Ax – Time delays" to "OFF-delay" or to "ON-delay and OFF delay".

The OFF-delay is now enabled and the desired OFF-delay time can be preset. After reception of an OFF-telegram, a parameterized time is started. A subsequent OFF-telegram retriggers the time only if the parameter "OFF-delay retriggerable ?" has been set to "Yes". The logical switching state will then be transferred to the following functions (e.g. logical operation, disabling / forced-control position function) and the output switched off, only after the OFF-delay has elapsed. An ON-telegram received during the OFF-delay will end the delay. The logical switching state corresponds in this case to "switched on".

- ❶ Feedback: If a time delay has been preset and if the switching state is changed via the "Switching" object, the time delay must have elapsed before feedback telegrams will be transmitted. Updates of the object from "ON" to "ON" or from "OFF" to "OFF" by retriggering during a running time delay has no influence on the switching status feedback.
- ❶ At the end of a disabling or forced-control position function, the state received during or set before the function can be tracked. Residual times of time functions are tracked, if they have not completely elapsed at the time the disabling or forced-control position functions are disabled. In case of a logical operation function, a switching state newly received via the "Switching" object will be executed with a time delay as well.
- ❶ The time delays have no influence on the staircase functions, if these are enabled.
- ❶ A time delay in progress will be completely terminated by a reset of the actuator (bus voltage failure or ETS programming)

Staircase function

The staircase function can be parameterized for each output separately and used for realizing time-controlled staircase lighting or functionally similar applications. The staircase function must have been enabled on parameter page "Ax – Enabled functions" separately for each output before the required communication objects and parameters (on parameter page "Ax – Staircase function") are visible.

The staircase function is controlled by means of the "Staircase function start / stop" communication object and is independent of the "Switching" object of the output (cf. Fig. 10). This feature permits 'parallel operation' of time and normal control, with always the last command being executed.

A telegram to the "Switching" object or a scene recall during an active staircase function ends the staircase time prematurely and sets the output to the switching state corresponding to the object value (time delays taken into account) or the scene value received. Similarly, the switching state of the "Switching" object or a scene recall can be overridden by a staircase timer function.

In combination with a disabling function a time-independent permanent lighting function can also be realized (cf. "Disabling function").

As can be seen from the functional diagram, the staircase function can also be combined with other output functions. The combination with the logic function is, however, not available.

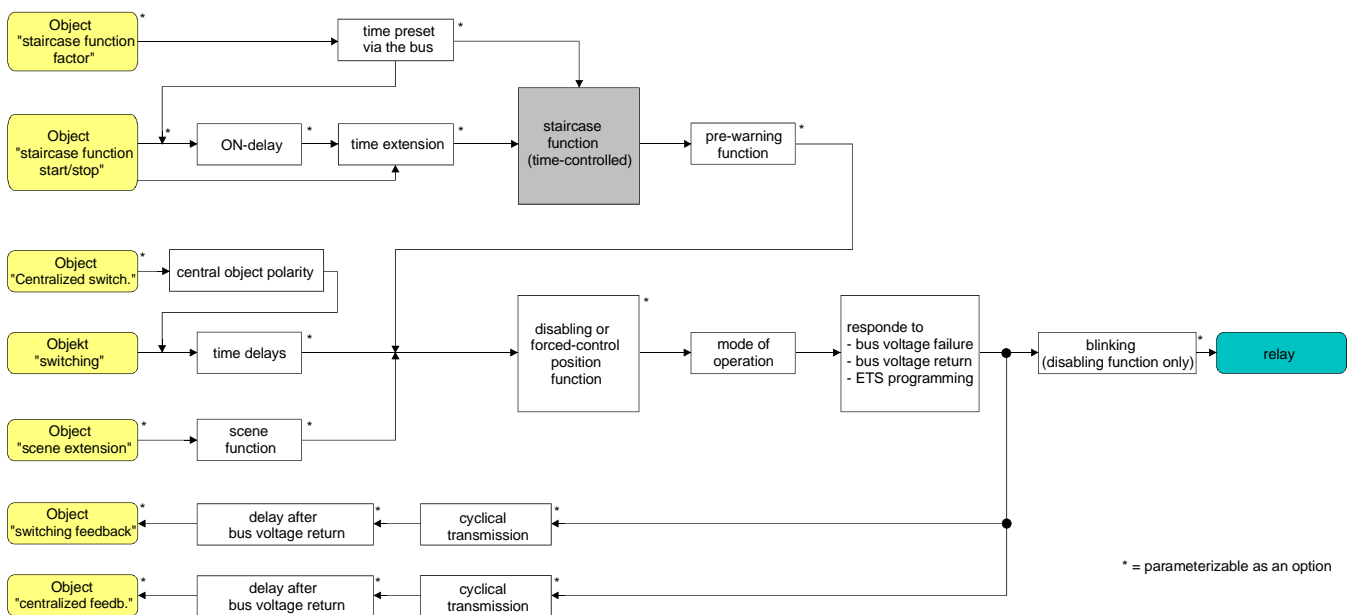

Fig. 10: Functional diagram of the staircase function

The staircase function can be enlarged by a supplementary function with the possibility of activating a time extension. By means of the object "Staircase function start / stop", the "time extension" permits retriggering an activated staircase time n times. As an alternative, "Time preset via the bus" can be selected. With this supplementary function, the parameterized staircase time can be multiplied with a factor received from the bus and thus dynamically adapted.

The staircase function can moreover be enlarged by a separate ON-delay and by a pre-warning function. In acc. with DIN 18015-2, the pre-warning function is designed to warn a person in the staircase that the lights will go out shortly.

Defining the switch-on behaviour of the staircase function

An ON-telegram to the "Staircase function start / stop" activates the staircase lighting time (T_{ON}) the duration of which is defined by the parameter "Staircase time". In addition, an ON-delay (T_{delay}) can be activated (cf. "Presetting the ON-delay for the staircase function"). At the end of the staircase lighting time, the output switches off or optionally activates the pre-warning time ($T_{pre-warn}$) of the pre-warning function (cf. Presetting the pre-warning function of the staircase function). With a possible ON-delay and a pre-warning function, the staircase function has the switch-on behaviour as shown in Fig. 11.

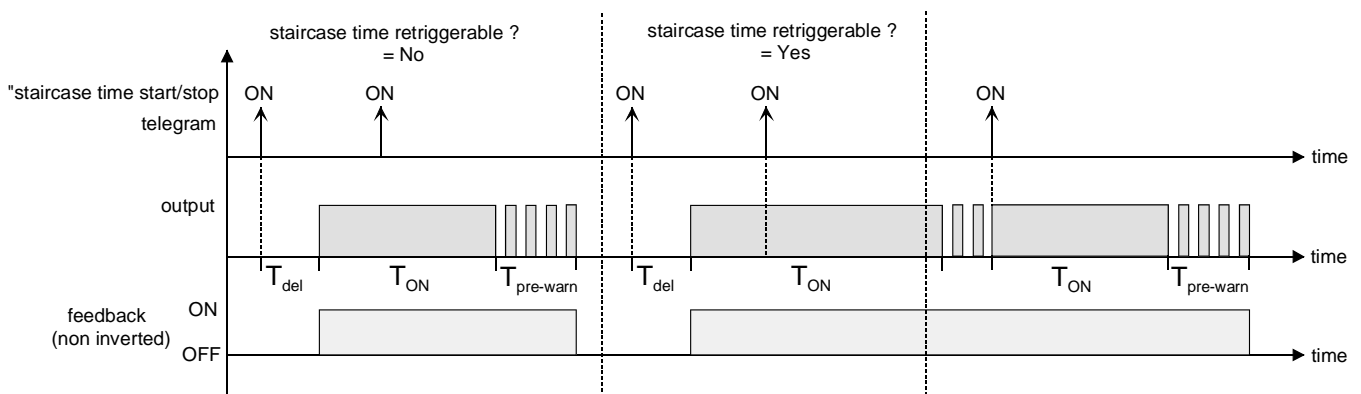

Fig. 11: Switch-on behaviour of the staircase function

The parameter "Staircase time retriggerable ?" defines whether the staircase lighting time can be re-triggered or not.

The staircase function must have been enabled on parameter page "Ax – Enabled functions (x = number of output).

- Set the parameter "Staircase time retriggerable ?" to "Yes".
Every ON-telegram received during the ON-phase of the staircase lighting time re-triggers the staircase time completely.
 - Set the parameter "Staircase time retriggerable ?" to "No".
ON-telegrams received during the ON-phase of the staircase time will be rejected. The staircase lighting time will not be re-triggered.
- ⓘ An ON-telegram received during the pre-warning time always re-triggers the staircase lighting time independent of the "Staircase time retriggerable ?" parameter.
- ⓘ If the supplementary function "Time extension" is active, the "Staircase time retriggerable ?" parameter cannot be changed. In this case, the parameter is set to "No" and cannot be changed.

Defining the switch-off behaviour of the staircase function

In a staircase function, the reaction to an OFF-telegram to the "Staircase function start / stop" object can also be parameterized. Without reception of an OFF-telegram, the output switches off after the pre-warning time has elapsed. With a possible ON-delay and a pre-warning function, the staircase function has a switch-off behaviour as shown in Fig. 12.

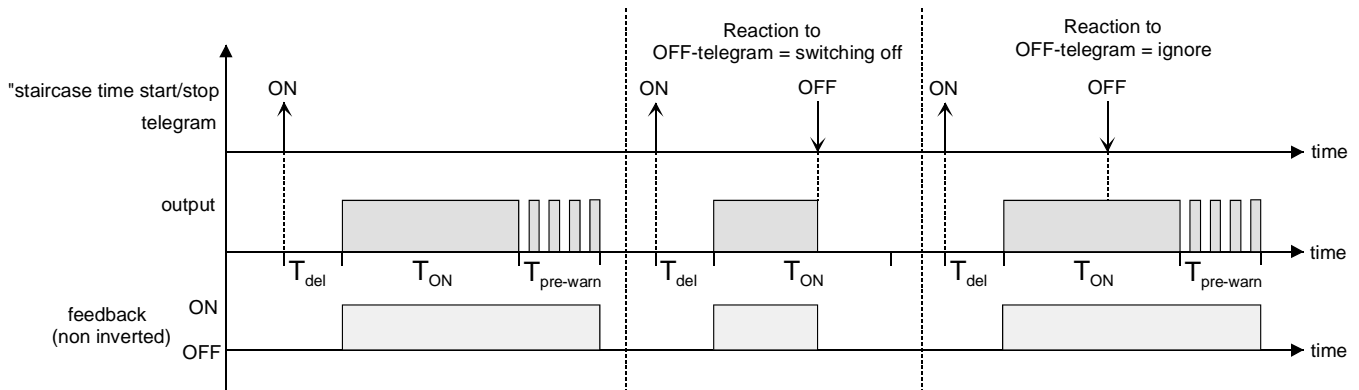

Fig. 12: Switch-off behaviour of the staircase function

The parameter "Reaction to OFF-telegram" defines whether the staircase time (T_{ON}) of the staircase function can be stopped prematurely.

The staircase function must have been enabled on parameter page "Ax – Enabled functions (x = number of output).

- Set the parameter "Reaction to OFF-telegram" to "Switching off"
The output shuts off immediately when an OFF-telegram is received via the object "Staircase function start / stop" during the ON-phase of the staircase time. If the staircase time is stopped prematurely by such a telegram, there is no pre-warning, i.e. the pre-warning time is not started.
- Set the parameter "Reaction to OFF-telegram" to "Ignore".
OFF-telegrams received during the ON-phase of the staircase time will be rejected. The staircase time will be executed completely, if applicable with a pre-warning.

i In the supplementary function "Time preset via the bus", the staircase time of the staircase function can also be started by the reception of a new time factor (cf. "Supplementary function of the staircase function – time preset via bus"). A factor of "0" received in this case will be interpreted as an OFF-telegram. The parameter "Reaction to OFF-telegram" is evaluated in this case, too, so that a staircase time can be terminated prematurely.

Presetting the ON-delay for the staircase function

An ON-telegram to activate the staircase function can also be evaluated with a time delay. This ON-delay can be activated separately for the staircase function and has no influence on the parameterizable time delays for the "Switching" object.

The staircase function must have been enabled on parameter page "Ax – Enabled functions (x = number of output).

- Set the parameter "Activate ON-delay for staircase function ?" on parameter page "Ax – Staircase function" to "Yes".

The ON-delay for the staircase function is now enabled and the desired ON-delay time can be preset. The ON-delay is started after reception of an ON-telegram to the "Staircase function start / stop" object. A subsequent ON-telegram retriggers the time only if the parameter "ON-delay retriggerable ?" has been set to "Yes". The staircase time is activated and the output switched on only after the time delay has elapsed.

- ❗ An OFF telegram via the "Staircase function start / stop" object during the ON-delay ends the delay only if the parameter "Reaction to OFF telegram" is set to "switching off". Otherwise the OFF telegram will be ignored.
- ❗ If the supplementary function "Time extension" is set, the "On-delay retriggerable ?" parameter cannot be changed. In this case, the parameter is set to "No" and cannot be changed.

Presetting the pre-warning function of the staircase function

The pre-warning function complies with DIN 18015-2 and is designed to warn a person in the staircase that the lights will go out shortly. As a pre-warning, the lamps connected to the output are switched off several times for a short instant before the output is shut off definitely. The pre-warning time ($T_{\text{pre-warn}}$), the duration of the interruptions during the pre-warning ($T_{\text{interrupt}}$) and the number of pre-warning interruptions can be parameterized (cf. Fig. 13 - example). The pre-warning time is added to the staircase lighting time (T_{ON}). The pre-warning time has an influence on the value of the feedback object so that the value "0" (non-inverted transmission) is tracked in the feedback object only after the pre-warning time has elapsed.

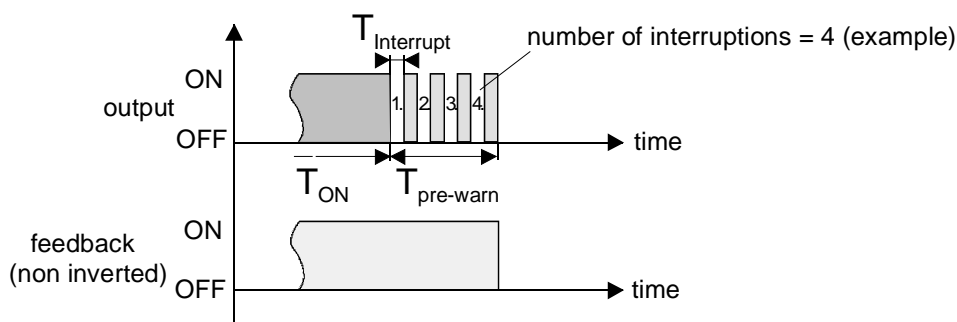

Fig.13: The pre-warning function of the staircase function

The staircase function must have been enabled on parameter page "Ax – Enabled functions (x = number of output).

- Set the parameter "Activate pre-warning time ?" on parameter page "Ax – Staircase function" to "Yes".
The pre-warning function is now enabled and the desired pre-warning time ($T_{\text{pre-warn}}$) can be preset.
 - Set the parameter "Number of pre-warnings" on parameter page "Ax – Staircase function" to the desired value (1...10).
The lamps connected to the output will then be switched off exactly as many times as programmed in this parameter. The 1st pre-warning is always executed at the beginning of the total pre-warning time.
 - Set the parameter "Time for pre-warning interruptions" on parameter page "Ax – Staircase function" to the desired value.
An interruption ($T_{\text{interrupt}}$) during the pre-warning time is as long as programmed in this parameter. A presettable interruption time permits adapting the shut-off phase of the lighting individually to the lamp type used.
- ⓘ It must be ensured that the "Number of pre-warnings" and the "Time for pre-warning interruptions" are coordinated with the length of the total "pre-warning time". Thus, the total shut-off phase during a pre-warning ("Number of pre-warnings" + "Time for pre-warning interruptions") must not be chosen longer than the pre-warning time itself. Otherwise risk of malfunctions.
- ⓘ The actuator takes its power supply completely from the bus and switches the output relays only after a sufficient amount of energy has been stored. This means that the switching states cannot always be tracked because of the simultaneous state changes occurring when pre-warnings are active on several outputs at the same time. In case of simultaneous pre-warnings on several outputs the number of pre-warnings programmed should therefore be kept conveniently small.
- ⓘ With an ON-telegram to the "Staircase function start / stop" object during an active pre-warning function, the pre-warning time is stopped and the staircase time always restarted (independent of the "Staircase time retriggerable ?" parameter). The parameter "Reaction to OFF-telegram" is also evaluated during the pre-warning time so that an active pre-warning can be terminated prematurely by switching off.

Presetting the staircase lighting timer supplementary function "Time extension"

With the time extension function, the staircase time can be retriggered several times (i.e. extended) via the "Staircase function start/stop" object. The duration of the extension is defined by repeated operation of a control device (several ON-telegrams in succession). The parameterized staircase time can thus be extended by the parameterized factor (max. 5-fold). The extension is then always automatically added to the end of a simple staircase time (T_{ON}) (cf. Fig. 14).

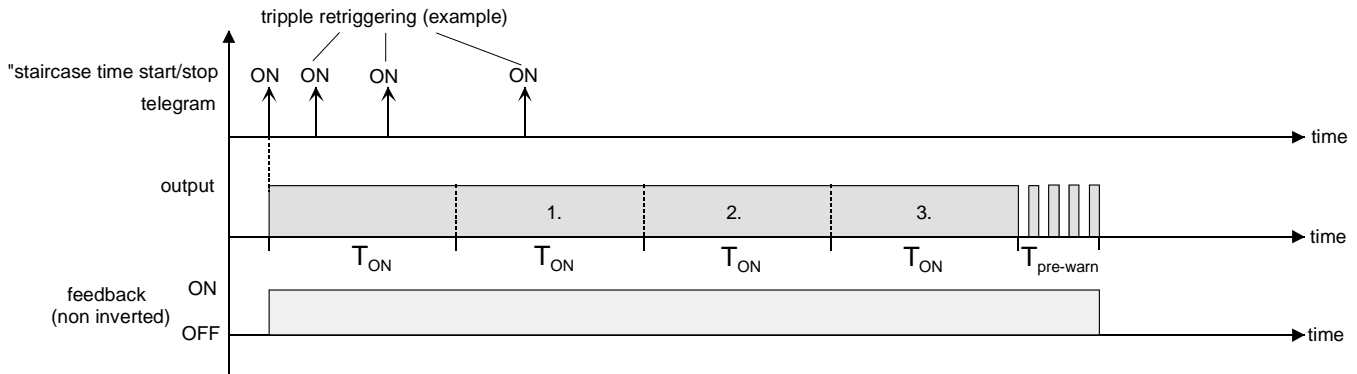

Fig. 14: Time extension for staircase lighting function

With this function, the lighting time in a staircase can be extended (e.g. by a person after shopping) by a defined length without having to retrigger the lighting every time the lighting shuts off automatically. The staircase function must have been enabled on parameter page "Ax – Enabled functions (x = number of output).

- Set the parameter "Supplementary function for staircase function" on parameter page "Ax – Staircase function" to "Time extension" and select the desired factor in the "Maximum time extension" parameter.

On reception of an ON-telegram to the "Staircase function start/stop" object, the staircase time is retriggered at the end of the ON-time as often as determined by the number of telegrams received, however, no longer as permitted by the parameterized factor.

Thus, the setting "3-fold" means that the started staircase time can be automatically retriggered at maximum three more times after elapsing. This means that the time corresponds to 4 times the basic time (cf. Fig. 14).

- ❗ Triggering of an extension can occur during the whole staircase time (T_{ON}). There is no restriction as to the time between two telegrams triggering an extension. Time extension telegrams are evaluated only during the staircase time. An ON-telegram during the pre-warning time triggers the staircase time like in a new start making another time extension possible. If an ON-delay has been programmed, the time extension request is evaluated already during the ON-delay.
- ❗ If a time extension has been parameterized as supplementary function, the parameters "Staircase time retriggerable?" and "ON-delay retriggerable?" are fixed to "No" since retriggering is effected by the time extension.

Presetting the staircase lighting timer supplementary function "Time preset via the bus"

With the time preset via the bus function, the parameterized staircase time can be multiplied with an 8-bit factor received from the bus and thus dynamically adapted. In this setting, the factor is derived from the "Staircase function factor" object. The factor for setting the staircase time lies in a range between 1...255.

The overall staircase time is the product of the factor (object value) and the base (parameterized staircase time) as follows...

Staircase time = (staircase time object value) x (staircase time parameter)

Example:

object value "Staircase function factor" = 5; parameter "Staircase time" = 10s.

→ staircase time selected = 5 x 10s = 50 s.

As an alternative, it is possible to define in the parameters of the staircase function whether the reception of a new factor starts at the same also the staircase time of the staircase function. In this case, the "Staircase function start/stop" object is not existing and starting and stopping is controlled by the factor value received.

The staircase function must have been enabled on parameter page "Ax – Enabled functions (x = number of output).

- Set the parameter "Supplementary function for staircase function" on parameter page "Ax – Staircase function" to "Time preset via the bus" and the parameter "Staircase function activatable via object 'Staircase function factor' ?" to "No".

The staircase time can be adapted dynamically by means of the "Staircase function factor" object. A value of "0" is interpreted as a value of "1". Starting and stopping of the staircase function is effected exclusively via the "Staircase function start/stop" object.

- Set the parameter "Supplementary function for staircase function" on parameter page "Ax – Staircase function" to "Time preset via the bus" and the parameter "Staircase function activatable via object 'Staircase function factor' ?" to "Yes".

The staircase time can be adapted dynamically by means of the "Staircase function factor" object. In addition, the staircase function is started on reception of a new factor with the new staircase lighting time (the "Staircase function start/stop" object is not existing. A factor value of "0" is interpreted as an OFF-telegram with the parameterized reaction to an OFF-telegram being evaluated in this case, too.

A large staircase with several floors is a good example for a possible application of the 'time preset via the bus' function with automatic starting of the staircase lighting time. A touch sensor on each floor of the house transmits a factor value to the staircase function. The higher the floor, the greater the transmitted factor value in order to ensure that the lights remain on longer when it takes more time to reach the upper floors. When a person enters the staircase of the house and after pressing of the touch sensor key, the staircase lighting time is now dynamically adapted and the lighting switched on at the same time.

- ❏ The staircase function is started with the reception of a new factor: A factor of > 0 received during the pre-warning time always re-triggers the staircase lighting time independent of the "Staircase time re-triggerable ?" parameter.
- ❏ After a reset (bus voltage return or programming with the ETS), the "Staircase function factor" object is always initialized with a "1". This alone is not sufficient for automatic starting of the staircase function (cf. "Presetting the behaviour of the staircase function after bus voltage return").
- ❏ The two supplementary functions "Time extension" and "Time preset via the bus" can now be parameterized as an alternative for one another.

Presetting the behaviour of the staircase function after bus voltage return

The staircase function can optionally be started automatically after bus voltage return.

The staircase function must have been enabled on parameter page "Ax – Enabled functions (x = number of output).

- Set the parameter "Behaviour after bus voltage return" on parameter page "Ax – General" to "Activate staircase function".

The staircase lighting time of the staircase function is started immediately after bus voltage return.

- ❗ For this setting it is indispensable that the staircase function has been programmed and enabled beforehand. When the staircase function has not been enabled, this setting will produce no reaction after return of the bus voltage.
- ❗ During an automatic start of the staircase function after return of the bus voltage, an ON-delay – even if parameterized in the staircase function – will not be started.
- ❗ The actuator takes its power supply completely from the bus and switches the output relays only after a sufficient amount of energy has been stored. For this reason, there may be a brief delay after a bus voltage return (5 s max.) before the device adopts the parameterized behaviour.
- ❗ The device adopts the parameterized behaviour only if the last ETS programming of the application or of the parameters occurred at least ca. 20 s ago. Otherwise ($T_{ETS} < 20$ s), the "Behaviour after ETS programming" will be adopted even after a return of bus voltage.
- ❗ The parameterized behaviour will only be adopted, if no forced control is activated after a bus voltage return.
- ❗ A switching state set after bus voltage return will be tracked in the feedback object as provided for in the "Mode of operation" parameter.

Scene function

Up to 8 scenes can be generated and the corresponding scene values stored in the actuator separately for each output. The scene values are recalled or stored via a separate scene extension object by means of extension telegrams. The datapoint type of the extension object permits addressing of up to 64 scenes max. For this reason, the scene number (1...64) with which the internal scene (1...8) is addressed can be determined in the parameterization of a scene.

The scene function must have been enabled on parameter page "Ax – Enabled functions" separately for each output before the required communication objects and parameters (on parameter page "Ax – Scenes") are visible.

The scene function can be combined with other functions of the output (cf. Fig. 15) with the command last received or selected always being executed:

A telegram to the "Switching" object or a scene recall or a scene storage telegram during an active staircase function ends the staircase lighting time prematurely and sets the output to the switching state corresponding to the object value (time delays taken into account) or the scene value received. Similarly, the output switching state set by the "Switching" object or a scene recall can be overridden by a staircase function or by the result of a logic function.

A combination of the function with cyclical monitoring is not possible.

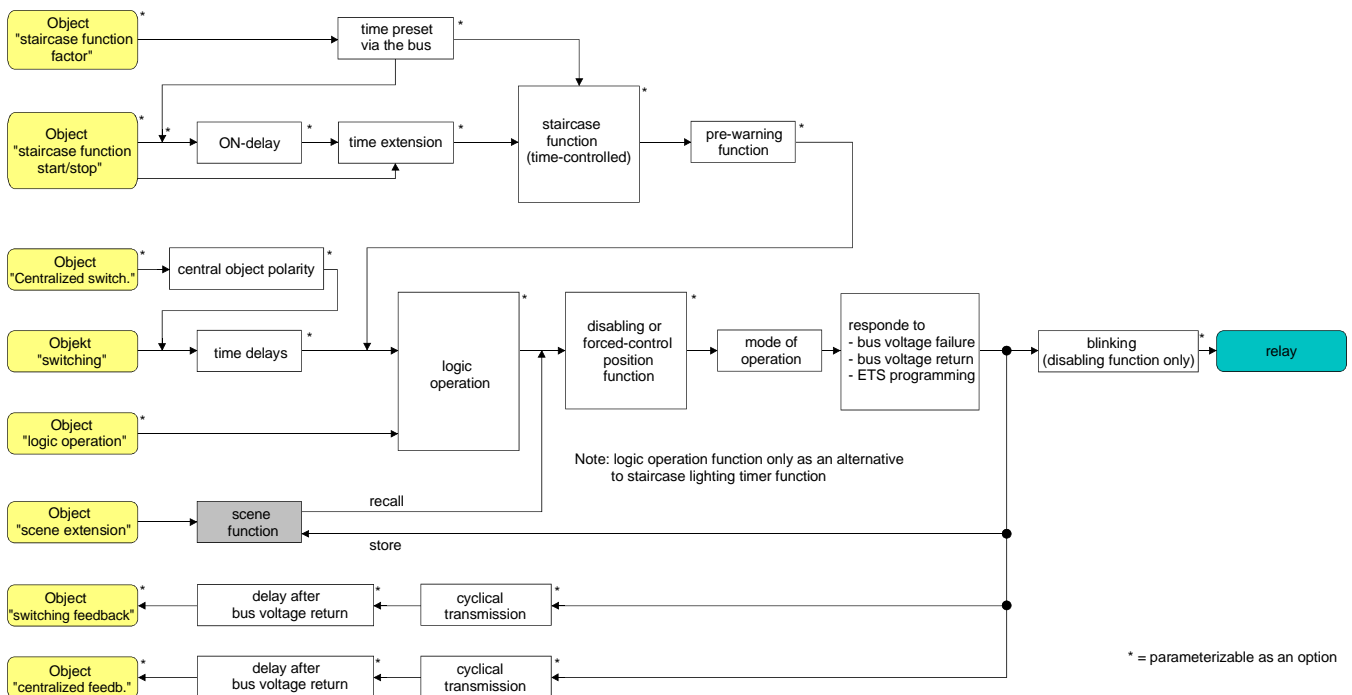

Fig. 15: Functional diagram of the scene function

Presetting a scene recall delay for the scene function

Each scene recall of an output can optionally also be delayed. With this feature, dynamical scene sequences can be configured if several outputs are combined with cyclical scene telegrams.

The scene function must have been enabled on parameter page "Ax – Enabled functions (x = number of output).

- Set the parameter "Delay scene recall?" on parameter page "Ax – Scenes" to "Yes"
The delay time is now activated and can be parameterized separately. The delay only influences the scene recall of the output. The delay time is started on arrival of a recall telegram. The corresponding scene will be recalled and the output set to the respective switching state only after this time has elapsed.
- ❗ Each scene recall telegram restarts the delay time and retriggers it. If a new scene recall telegram is received while a delay is active (scene recall not yet executed), the old (and not yet recalled scene) will be rejected and only the scene last received executed.
- ❗ The scene recall delay has no influence on the storage of scene values. A scene storage telegram within a scene recall delay terminates the delay and thus the scene recall.

Presetting the ETS download behaviour for the scene function

During storage of a scene, the scene values are stored permanently in the device (cf. "Presetting the storage behaviour for the scene function"). To prevent the stored values from being replaced during ETS programming of the application or of the parameters by the originally programmed scene switching states, the actuator can inhibit overwriting of the scene values. As an alternative, the original values can be reloaded into the device during each programming run of the ETS.

The scene function must have been enabled on parameter page "Ax – Enabled functions (x = number of output).

- Set the parameter "Overwrite values stored in the device during download ?" on parameter page "Ax – Scenes" to "Yes".
During each ETS programming of the application or of the parameters, the scene values parameterized in the ETS for the output concerned will be programmed into the actuator. Scene values stored in the device by means of a storage function will be overwritten, if any.
- Set the parameter "Overwrite values stored in the device during download ?" on parameter page "Ax – Scenes" to "Yes".
Scene values stored in the device with a storage function will be maintained. If no scene values have been stored, the switching commands last programmed in the ETS remain valid.
- ❗ When the actuator is put into operation for the first time, this parameter should be set to "Yes" so that the output is initialized with valid scene values. Otherwise, the values in the actuator are "0" (off) for all scenes.

Presetting scene numbers and scene switching state for the scene function

The datapoint type of the scene extension object permits addressing of up to 64 scenes max. For this reason, the scene number (1...64) with which the scene is addressed, i.e. recalled or stored, must be determined for each internal scene (1...8) of the output. Moreover, the switching state to be set for the output in case of a scene recall must be specified as well.

The scene function must have been enabled on parameter page "Ax – Enabled functions (x = number of output).

- Set the parameter "Scene x activatable by scene number" (x = number of the scene (1...8)) for each scene on parameter page "Ax – Scenes" to the numbers with which the scenes are to be addressed. A scene can be addressed with the parameterized scene number. A setting of "0" deactivates the corresponding scene so that neither recalling nor storage is possible.
- ❏ If the same scene number is parameterized for several scenes, only the scene with the lowest internal scene number (1...8) will be addressed. The other internal scenes will be ignored in this case.
- Set the parameter "Switching state for scene x" (x = number of the scene (1...8)) on parameter page "Ax – Scenes" for each scene to the desired switching command ("on" or "off").
In case of a scene recall, the parameterized switching command is recalled and the output is set correspondingly.
- ❏ The output is set to the switching command in a scene recall only if no forced-position or disabling function is active.
- ❏ The parameterized switching command is adopted in the actuator during programming with the ETS only if the parameter "Overwrite values stored in the device during an ETS download ?" is set to "Yes".

Presetting the storage behaviour for the scene function

The logical state established at the output in accordance with the functional diagram ("on" or "off") can be stored internally via the extension object during reception of a scene storage telegram. In this case, the switching state can be influenced before the storage by all functions of the output provided the individual functions have been enabled (e.g. also the disabling function, forced-control position function, etc.).

Rule of thumb: The logical state stored is the one that is reported to the bus by the non-inverted feedback telegram or the one that would have been reported back to the bus had the feedback function not been disabled.

The scene function must have been enabled on parameter page "Ax – Enabled functions (x = number of output).

- Set the parameter "Storage function for scene x" (x = number of the scene (1...8)) on parameter page "Ax – Scenes" for each scene to "Yes".
The storage function is activated for the scene in question. On reception of a storage telegram via the "Scene extension" object, the current logical state will be internally stored.
- Set the parameter "Storage function for scene x" (x = number of the scene (1...8)) on parameter page "Ax – Scenes" for each scene to "No".
The storage function is deactivated for the scene in question. A storage telegram received via the "scene extension" object will be rejected.

Operating hours counter

The operating hours counter tracks the ON-time of a switching output. For the operating hours counter an output is actively on, when the relay contact is closed, i.e. when current is flowing to the load. This means that the counter always evaluates closed contacts independent of the selected mode of operation (make or break contact) and of the logical feedback of the switching status.

The operating hours counter sums up the determined ON-time for a closed relay contact precise to the minute rounding the times off to the full hours (cf. Fig. 16). The accumulated operating hours are tracked in a 2-byte counter and stored permanently in the device. The current count can be transmitted cyclically or after the change of a counting interval to the bus via the communication object "Operating hours counter value".

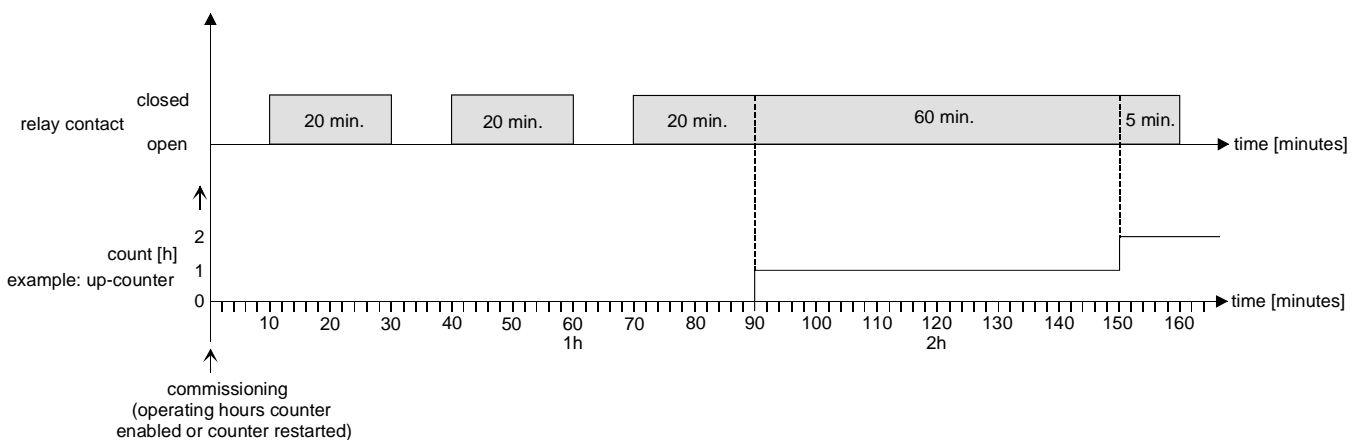

Fig. 16: Functional principle of the operating hours counter

In the state as delivered, all operating hours values of the actuator are zero and no operating hours will be counted if the counter has not been enabled in the parameters of the output concerned. If enabled, the operating hours counter begins counting and summing up the operating hours immediately after commissioning of the actuator.

If an operating hours counter is later on again disabled in the parameters and if it is then programmed with the counter disabled, all operating hours counted beforehand for the output concerned will be deleted. After re-enabling, the operating hours counter always begins with "0".

The operating hours stored in the device (full hours) are not lost after a bus voltage failure or after programming with the ETS. Accumulated operating minutes (full hour not yet reached) are, however, discarded in this case.

After bus voltage return or an ETS download, the actuator passively updates the communication object "Value operating hours counter" for each output. The object value can be read out, if the Read flag is set. The object value, if any, is actively transmitted to the bus depending on the automatic transmission parameters, as soon as the parameterized transmit delay after bus voltage return has elapsed (cf. "Presetting the transmission behaviour of the operating hours counter").

Any manual switching of the relays by means of the slide switches is not detected by the operating hours counter. This means that manual closing of a contact does not activate the operating hours counter and that manual opening does not interrupt a counting cycle in progress.

Activating the operating hours counter

- Set the parameter "Operating hours counter" on parameter page "Ax – Enabled functions" to "Enabled".

The operating hours counter is activated.

Deactivating the operating hours counter

- Set the parameter "Operating hours counter" on parameter page "Ax – Enabled functions" to "Disabled".

The operating hours counter is deactivated.

- ⓘ Disabling of the operating hours counter and subsequent programming with the ETS causes the counter to be reset to "0".

Presetting the counting mode of the operating hours counter

The operating hours counter can be configured as an up-counter or a down-counter. Depending on the above mode, the counter permits presetting a limit or starting value which can be used, for instance, to monitor the hours in operation of a lamp by restricting the counting range.

Up-counter:

After activation of the operating hours counter by enabling it in the ETS or by a restart, the operating hours will be counted started from "0". The maximum counting capacity is 65535 hours. Thereafter, the counter stops and reports reaching the maximum count via the "Runout operating hours counter" object.

As an option, a limit value can be preset either in the ETS or via the communication object "Limit value operating hours counter". In this case, the counting status is reported to the bus via the "Runout operating hours counter" object already when the limit value is reached. If not restarted, the counter will nevertheless continue counting until the max. capacity of 65535 hours is reached and stop thereafter. A new count begins only after the counter is new started.

Down-counter

After enabling the operating hours counter in the ETS, the count is "0" and the actuator reports for the output concerned after programming or after a bus voltage return via the "Runout operating hours counter" object that the counter is running. Only after a restart will the down-counter be preset to the max. value of 65535 and the counting operation be started.

As an option, a start value can be preset either in the ETS or via the communication object "Start value operating hours counter". If a start value has been preset, the down-counter will be initialized after a restart with this value instead of the max. value. The counter will then decrement the hours beginning with the start value. When the down-counter has reached "0", the counting status is reported to the bus via the "Runout operating hours counter" object and counting is stopped. A new count begins only after the counter is new started.

The operating hours counter must have been enabled on parameter page "Ax – Enabled functions (x = number of output).

- Set the parameter "Type of counter" on parameter page "Ax - Operating hours counter" (x = number of output) to "up-counter". If limit value monitoring is desired, set the parameter "Limit value pre-set ?" to "yes, as specified in parameter" or to "yes, as received via object". Otherwise, set the parameter to "no". In the "yes, as specified in parameter" setting, specify the required limit value (0...65535 h).

The counter increments the operating hours beginning with "0". If the limit value monitoring function is active, the actuator sends a "1" telegram for the output concerned via the "Runout operating hours counter" object as soon as the preset limit value is reached. Otherwise, the counter status will be transmitted only after reaching the max. value of 65535.

- Set the parameter "Type of counter" on parameter page "Ax - Operating hours counter" (x = number of output) to "down-counter". If a start value preset is required, set the parameter "Start value pre-set ?" to "yes, as specified in parameter" or to "yes, as received via object". Otherwise, set the parameter to "no". In the "yes, as specified in parameter" setting, specify the required start value (0...65535 h).

After a restart, the counter decrements the operating hours until "0" is reached. If the start value preset mode is active, the counter counts down from the start value. Otherwise, counting begins from the max. value 65535. The actuator sends a "1" telegram for the output concerned via the object "Runout operating hours counter" as soon as "0" is reached.

- ① The value of the communication object "Runout operating hours counter" is stored internally in a non-volatile memory. After bus voltage return or after ETS-programming, the object will be re-initialized with the previously stored value. If an operating hours counter is in this case identified as elapsed, i.e. if the object value is a "1", an additional telegram will be actively transmitted to the bus as soon as the parameterized transmit delay has elapsed after bus voltage return. If the counter has not yet run out (object value "0"), then no telegram will be sent after bus voltage return or programming with the ETS.
- ① In case of start value preset via communication object: The values received via the object will be adopted as valid only after a restart of the operating hours counter and stored internally in a non-volatile memory. After bus voltage return or after ETS-programming, the object will be initialized with the last stored value. The values received are lost during a bus voltage failure or an ETS download, if the counter has not been restarted beforehand. For this reason, it is recommended to always restart the counter whenever a new start or limit value is being preset.
As long as no limit or start value has been received via the object, a fixed standard value of 65535 is the default. The values received via the object and stored will be reset to the default value, if the operating hours counter is disabled in the parameters of the ETS and if an ETS download is made.
In case of limit or start value preset: If the start or limit value is being preset as "0", the following cases must be distinguished...
Preset as parameterized: The counter runs out immediately after enabling with ETS download or after a counter restart.
Preset via object: A counter restart will be ignored to avoid an undesired reset (e.g. site operation → hours already counted by manual operation).
- ① If the counting direction of an operating hours counter is reversed by parameter change in the ETS, the counter should always be restarted after programming of the actuator to ensure its re-initialization.

Restarting the operating hours counter

The operating hours count can be reset at any time by the "New start operating hours counter" communication object. The polarity of the restart telegram object is fixed. "1" = restart / "0" = no reaction. In case of an up counter, the counter will be initialized during restart with a "0" and in case of a down counter with the start value. If no start value has been parameterized or preset via the object, the start value is fixed with 65535.

During each restart of the counter, the initialized count will be transmitted actively to the bus.

During a restart, the "Runout operating hours counter" message will be reset as well. In this case, a "0" telegram will be transmitted to the bus via the "Runout operating hours counter" object.

In addition, the limit or start value will be initialized as well.

- ❗ If a new limit or start value has been preset via the communication object, the counter should always be restarted thereafter. Otherwise, the received values will be lost during a bus voltage failure or an ETS download.
- ❗ If a start or a limit value is preset with "0", the device will show different reactions during a restart depending on the type of value preset...
 - Preset like parameter:
The counter runs out immediately after a counter restart.
 - Preset via object:
A counter restart will be ignored to avoid an undesired reset (e.g. after installation of the devices with hours already being counted by manual operation). To perform the restart, it is necessary to preset at first a start or limit value greater than "0".

Presetting the transmit behaviour of the operating hours counter

The current value of the operating hours counter is always tracked in the communication object "Value operating hours counter". After bus voltage return or an ETS download the actuator passively updates the communication object "Value operating hours counter" for each output. The object value can be read out, if the "Read" flag is set.

In addition, the transmit behaviour of this communication object can be preset.

The operating hours counter must have been enabled on parameter page "Ax – Enabled functions (x = number of output).

- Set the parameter "Automatic transmission of counting value" on parameter page "Ax – Operating hours counter" (x = number of output) to "after change by interval value". Set the "Counting value interval (1...65535 h)" to the desired value.
 - The count is transmitted to the bus as soon as it changes by the preset count value interval. After bus voltage return or after ETS programming, the object value will be automatically transmitted after the "Delay after bus voltage return" has elapsed, when the current count corresponds to the count value interval or a multiple thereof. A count of "0" will in this case always be transmitted.
- Set the parameter "Automatic transmission of counting value" on parameter page "Ax – Operating hours counter" (x = number of output) to "cyclical".
 - The count value is transmitted cyclically. The cycle time is defined channel-independent on the parameter page "Time settings". After bus voltage return or after programming with the ETS, the count will be transmitted to the bus for the first time after the parameterized cycle time has elapsed.

Supplementary functions

For each output, supplementary functions can be enabled. As supplementary function, a disabling function or alternatively a forced-control position function can be configured. Only one of these functions can be enabled for an output. Additionally, a logical operation function can be parameterized. These additional functions are enabled on parameter page "Ax – Supplementary functions" (x = number of output).

Presetting the disabling function as supplementary function

As can be seen from the functional diagram (cf. Fig. 17), the disabling function can also be combined with other output functions. In case of an active disable, the upstream functions are overridden so that the output concerned will be locked in the disabled state. The override feature can also be used to implement a permanent lighting function.

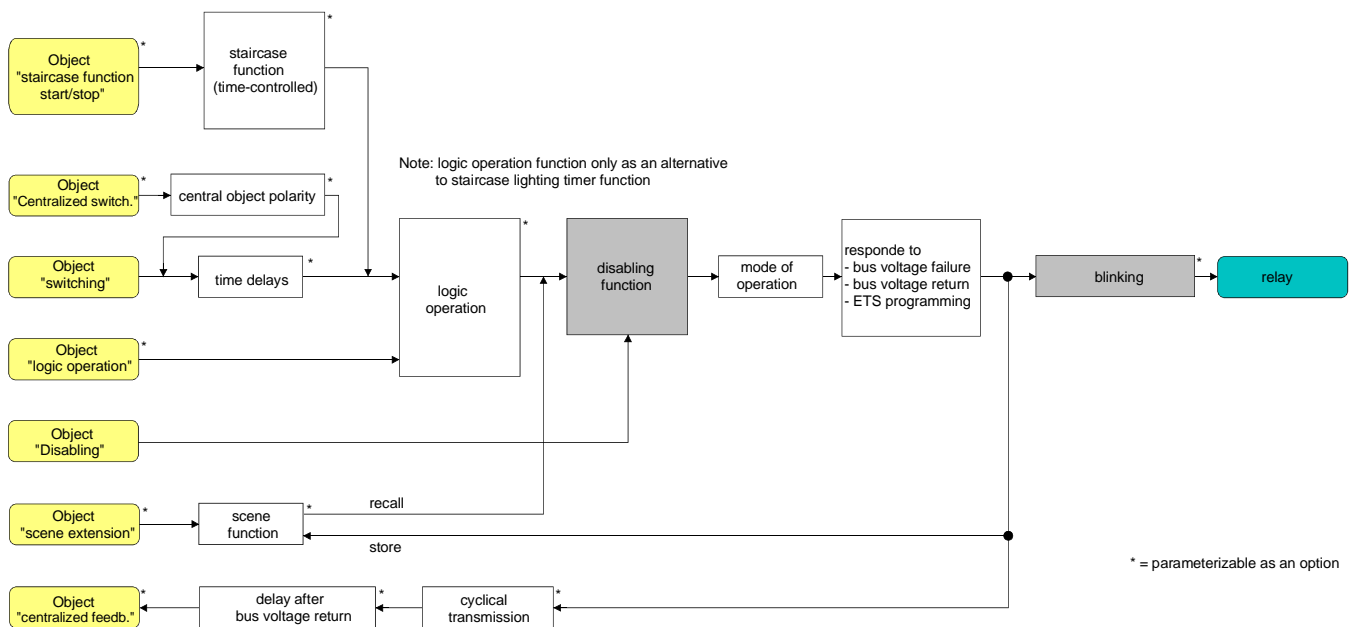

Fig. 17: Functional diagram of the disabling function

- Set the parameter "Selection of supplementary function" on parameter page "Ax – Supplementary functions" to "Disabling function".
The disabling function is enabled. The "Disabling" communication object and the parameters of the disabling function are visible.
- Set the parameter "Polarity of disable object" on parameter page "Ax – Supplementary functions" to the desired polarity.
- ⓘ After bus voltage return or programming of the application or of the parameters with the ETS, the disabling function is always deactivated (object value "0"). In the inverted setting ("1 = enabled; 0 = disabled"), a "0" telegram update must first be sent after the initialization before the disabled state is activated.
- ⓘ Updates of the disabling object from "ON" to "ON" or from "OFF" to "OFF" show no reaction. The relay remains in the position last set, if applicable also set manually.
- ⓘ An output disabled via the bus can still be operated by hand!

- Set the parameter "Behaviour at the beginning of the disabling function" on parameter page "Ax – Supplementary functions" to the desired behaviour.

At the beginning of disabling, the parameterized behaviour will be executed and the output locked. When the setting "No change of switching state" is selected, the relay of the output shows no reaction and remains in the switching state last set (switching state in acc. with last non-inverted feedback telegram). When the setting "Blinking" is selected, the output is switched on and off cyclically during disabling. The blinking time is generally parameterized for all outputs on the "General" parameter page. During blinking, the logic switching state is "ON - 1".
- Set the parameter "Behaviour at the end of the disabling function" on parameter page "Ax – Supplementary functions" to the desired behaviour.

At the end of disabling, the parameterized behaviour will be executed and the output re-enabled. When the setting "No change of switching state" is selected, the relay of the output shows no reaction and remains in the state last set by the disabling function. When the setting "Setting tracked state" is selected, the last switching state existing before the disabling function or the switching state internally tracked during the disabling function will be set. In this case, residual times of time functions or of the staircase functions will be tracked as well, if they have not completely elapsed at the time of re-enabling the disabling function. In the settings "No change of switching state", "Switching on", "Switching off" or "Blinking", the states set at the end of the disabling function have no influence on time or staircase functions. When the setting "Blinking" is selected, the output is switched on and off cyclically after disabling. Blinking persists until a new switching state is set. The blinking time is generally parameterized for all outputs on the "General" parameter page. During blinking, the logic switching state is "ON - 1".
- ⓘ The states defined for the end of the disabling function override a logic function if parameterized. The parameterized logic operation will be executed and the result forced on the output only if at least one input state of the logic operation changes or is updated after the disabling state has been suspended.
- ⓘ Blinking: The actuator takes its power supply completely from the bus and switches the output relays only after a sufficient amount of energy has been stored. In case of blinking with short intervals this means that switching states cannot always be tracked because of the simultaneous state changes in several outputs. For this reason, it is important to program sufficiently long blinking rates if several outputs are to blink at the same time.

Presetting the forced-control position function as supplementary function

As can be seen from the functional diagram (cf. Fig. 18), the forced-control position function can also be combined with other output functions. In case of an active forced-control position function, the upstream functions are overridden so that the output concerned will be locked in the forced position.

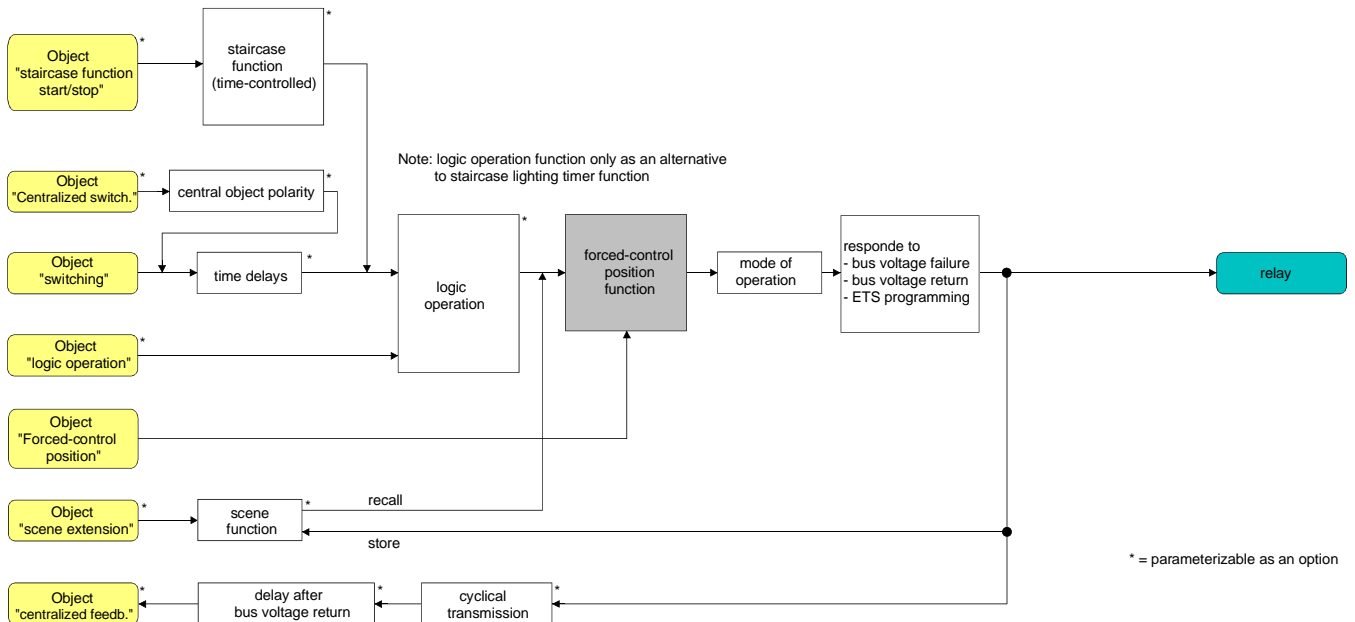

Fig. 18: Functional diagram of the forced-control position function

- Set the parameter "Selection of supplementary function" on parameter page "Ax – Supplementary functions" to "Forced-control position".

The forced-control position function is enabled. The "Forced-control position" communication object and the parameters of the forced-control position function are visible.

In case of the 2-bit forced-control position, the switching state of the output is directly determined by the forced-control position telegram. The first bit (bit 0) of the "Forced-control position" object specifies the switching state to be forced on the output. The second bit (bit 1) activates or deactivates the forced control (cf. table 1).

Bit 1	Bit 0	Function
0	x	forced-control position not active ⇨ normal control
0	x	forced-control position not active ⇨ normal control
1	0	forced-control position active: switching off
1	1	forced-control position active: switching on

Table 1: Bit coding of forced-control position

- Updates of the forced-control position object from "Forced-control position ON" to "Forced-control position ON" will cause the relay every time to switch the contact into the forced-control position. Updates from "Forced-control position OFF" to "Forced-control position OFF" remain without effect.
- An output under forced control from the bus can still be operated by hand!

- Set the parameter "Behaviour at the end of the forced-control position function" on parameter page "Ax – Supplementary functions" to the desired behaviour.

At the end of the forced-control position function, the parameterized behaviour will be executed and the output re-enabled for normal control. When the setting "No change of switching state" is selected, the relay of the output shows no reaction and remains in the state last set by the forced-control position function.

When the setting "Tracking the switching state" is selected, the switching state last existing before forced control or the one tracked internally while the forced-control position function was active will be set at the end of the forced-control position function. In this case, residual times of time functions or of the staircase functions will be tracked as well, if they have not completely elapsed at the time of re-enabling the disabling function. In the settings "No change of switching state", "Switching on" or "Switching off", the states set at the end of the forced-control position function have no influence on time or staircase functions.

- ❗ The states defined for the end of the forced-control position function override a logic function if so parameterized. The parameterized logic operation will be executed and the result forced on the output only if at least one input state of the logic operation changes or is updated after the forced-control state has been suspended.

The communication object of the forced-control position function can be initialized after bus voltage return. In this way, the switching state of the output can be influenced when the forced-control position function is activated.

- Set the parameter "Behaviour after bus voltage return" on parameter page "Ax – Supplementary functions" to the desired behaviour.

After bus voltage return, the parameterized state is adopted in the "Forced-control position" communication object. In case of an active forced position, the output will be switched immediately after bus voltage return to the corresponding state and locked by forced control until the forced-position condition is cancelled via the bus. The parameter "Behaviour after bus voltage return" will in this case not be evaluated for the output concerned.

If "State of forced-control as before bus voltage failure" is selected, the forced-control is set to the state which was stored in a non-volatile memory at the time of bus voltage failure. After programming of the application or of the parameters with the ETS, the value is in this case always internally set to "Not active".

- ❗ After bus voltage return or programming of the application or of the parameters with the ETS, the forced-control position function is always deactivated (object value "0").

Presetting the logic function as supplementary function

A logic function can be parameterized separately and independently for each output. This function permits linking the state of the "Switching" object with an additional logic operation object. The state of the communication object for "Switching" can also be evaluated with a delay when an ON-delay or an OFF-delay are defined.

As can be seen from the functional diagram (cf. Fig. 19), the logic function can also be combined with other output functions. A combination with the staircase or the cyclical monitoring function is, however, not possible.

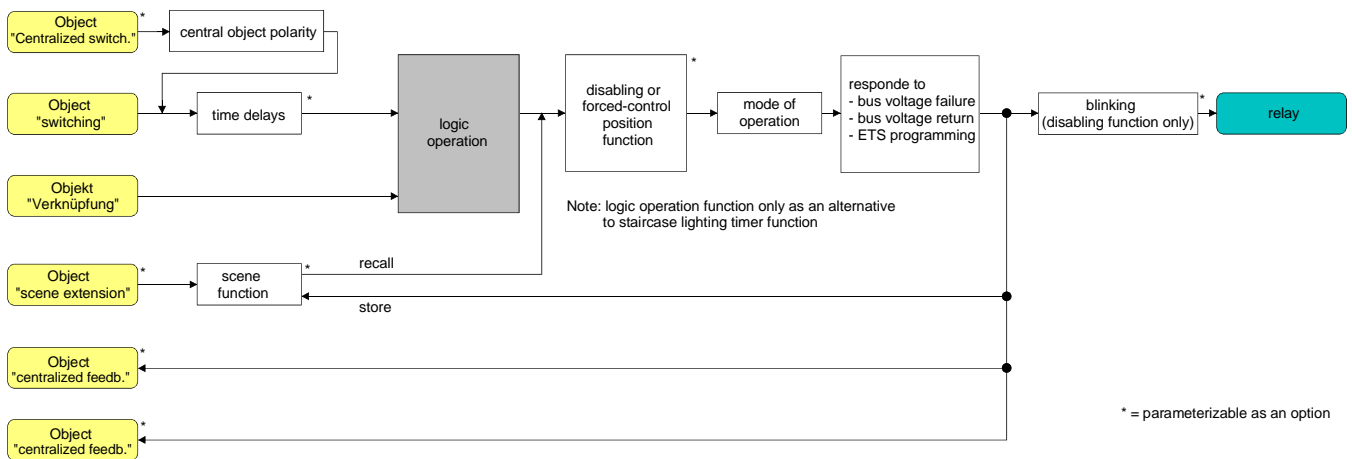

Fig. 19: Functional diagram of the logic function

The following gating operations can be parameterized (cf. Fig. 20)

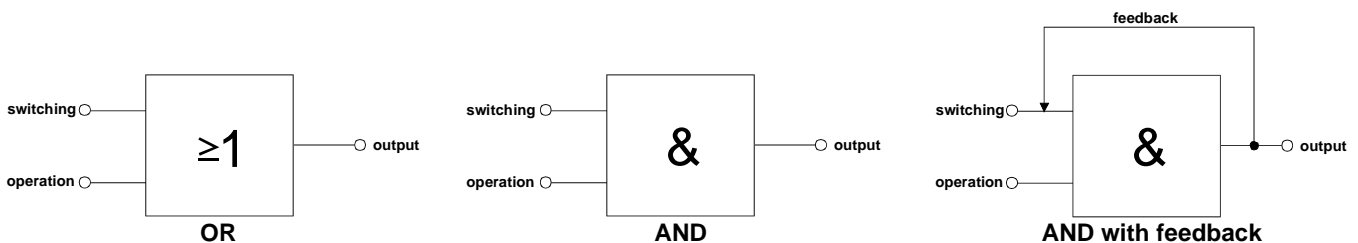

Fig. 20: Gating operations of the logic function

i "AND with feedback:"

With a logic object = "0", the output is always "0" (logic AND). In this case, the feedback signal from the output to the "switching" input will directly reset this input when it is being set. Only if the logic operation object = "1", can the output adopt the logic state "1" after a new "1" has been received on the "Switching" input.

The "Logic operation" object can be initialized after bus voltage return or programming with the ETS with a previously parameterized value so that in case of a telegram update to the "Switching" object a correct operation result is determined immediately and the output set correspondingly.

- Set the parameter "Logic operation function ?" on parameter page "Ax – Supplementary functions" to "Yes".

The logic function is enabled. The "Logic operation" communication object and the parameters of the logic function are visible.

- Set the parameter "Type of logic operation" on parameter page "Ax – Supplementary functions" to the desired type of logic operation.

- Set the parameter "Value of logic operation object after bus voltage return" and "Value of logic operation object after ETS download" on parameter page "Ax – Supplementary functions" to the desired initial conditions.

After bus voltage return or after ETS programming of the application software or of the parameters, the "Logic operation" object is initialized with the preset switching states"

- ❗ After an actuator reset (bus voltage return or ETS programming), the logic function will be executed only if at least one input object of the logic operation is updated by means of a telegram from the bus.
- ❗ The states preset for the end of a disabling or forced-control position function or the switching states that are set after ETS programming, bus voltage failure or after bus voltage return will override the logic function. The parameterized logic operation will be executed and the result forced on the output only if at least one input state of the logic operation changes or is updated.

4.2.4.3 Delivery state

The actuator is delivered with no application program loaded. The relays can be operated manually. There is no feedback to the bus in this case.

The device can be programmed and put into operation with the ETS. The physical address is preset to 15.15.255.

4.2.5 Parameters

Description:	Values:	Remarks:
 General		
Delay after bus voltage return Minutes (0...59)	0...59	To reduce telegram traffic on the bus line after bus voltage activation (bus reset), after connection of the device to the bus line or after programming with the ETS, it is possible to delay all active feedbacks of the actuator. The parameter specifies in this case a delay for all devices. Feedback telegrams for initialization will be transmitted to the bus only after the parameterized delay time has elapsed, if the feedback telegrams are to be transmitted with a time delay. Setting the minutes of the delay time.
Seconds (0...59)	0...17...59	Setting the seconds of the delay time.
Central function ?	yes no	Setting "yes" enables the central function and thus the "Central switching" object. Individual switching outputs can be assigned to the central function only if the function is enabled
Central object polarity	0 = switching off ; 1 = switching on 0 = switching on; 1 = switching off	The parameter sets the polarity of the central object.

<p>Make use of centralized feedback ?</p>	<p>no yes, active message object yes, passive status object</p>	<p>To keep the telegram load low during a 'bus initialization', the centralized feedback function of the actuator can be employed. Setting "yes" activates the centralized feedback and enables the corresponding object. The parameter moreover defines whether the feedback telegrams are transmitted actively (telegram transmission in case of changes) or passively (telegram transmission only as a response to a 'Read' request). The communication flags of the object are automatically set by the ETS according to the setting.</p>
<p>Time delay for feedback telegram after bus voltage return ?</p>	<p>yes no</p>	<p>The centralized feedback telegram can be transmitted to the bus with a delay after bus voltage return or after programming with the ETS. Setting "Yes" activates the delay time of the centralized feedback in case of bus voltage return. The delay time is parameterized under "General" (see above). i This parameter is visible as an active message object only if centralized feedback is enabled.</p>
<p>Cyclical transmission of centralized feedback telegram ?</p>	<p>Yes (transm. cyclic and in case of changes)</p> <p>No (transmission only in case of changes)</p>	<p>The object value of the centralized feedback can be transmitted cyclically. The feedback telegram is transmitted to the bus cyclically and after state changes. The cycle time is generally programmed under the "Time settings" entry for all feedback telegrams. The feedback telegram is transmitted to the bus only after state changes. i This parameter is visible as an active message object only if centralized feedback is enabled.</p>

Blinking rate
 1 s
 2 s
 5 s
 10 s

At the beginning and at the end of a disabling function (if used), switching outputs can also be parameterized as "blinking". In this case, the outputs change the switching state cyclically. The "Blinking rate" parameter generally defines the ON-time and the OFF-time of a "blinking" output signal for all outputs.

Example:
 Blinking rate = 1 s
 → 1 s off → 1 s on → 1 s off ...

i The actuator takes its power supply completely from the bus and switches the output relays only after a sufficient amount of energy has been stored. In case of blinking with short blinking rate this means that switching states cannot always be tracked because of the simultaneous state changes in several outputs. For this reason, it is important to program sufficiently long blinking rate if several outputs are to blink at the same time.

 Time settings

Time for cycl. monitoring 0...23
 Hours (0...23)

If desired, outputs can be assigned independent of one another to the cyclical monitoring function. If no telegram update on the "Switching" object has been received after the monitoring time has elapsed, the corresponding output relay is set to its default position. The parameter "Time for cycl. monitoring" generally defines the monitoring time for all outputs.

Setting the monitoring time hours.

Minutes (0...59) 0...2...59

Setting the monitoring time minutes.

Seconds (10...59)	10...59	Setting the monitoring time seconds. <i>Default setting: 2 minutes 10 seconds</i>
Time for cyclical transmission of feedback tel. Hours (0...23)	0...23	Depending on parameterization, the different active feedback telegrams of the actuator can transmit their state also cyclically to the bus. The parameter "Time for cyclical transmission of feedback tel." generally defines the cycle time for all outputs. Setting the cycle time hours.
Minutes (0...59)	0...2...59	Setting the cycle time minutes.
Seconds (10...59)	10...59	Setting the cycle time seconds. <i>Default setting: 2 minutes 10 seconds</i>
Time for cyclical transmission operating hours Hours (0...23)	0...23	Depending on parameterization, the operating hours counters of the outputs can also transmit their count cyclically to the bus. The parameter "Time for cyclical transmission operating hours" generally defines the cycle time for all outputs. Setting the cycle time hours.
Minutes (0...59)	0...59	Setting the cycle time minutes.
Seconds (10...59)	10...59	Setting the cycle time seconds. <i>Default setting: 23 hours 0 minutes 10 seconds</i>

 Ax – General (x = number of output / All outputs can be parameterized independent of one another.)

Mode of operation		The relays of a switching output can be parameterized as make or break contacts. This feature offers the possibility of inversion the switching states.
	(make contact)	Switching state = off ("0") → relay contact open Switching state = on ("1") → relay contact closed
	break contact	Switching state = off ("0") → relay contact closed Switching state = on ("1") → relay contact open
Behaviour after ETS programming		The actuator permits setting the preferred relay contact position after ETS programming separately for each output.
	close contact	The relay contact is closed after an ETS programming cycle.
	open contact	The relay contact is opened after an ETS programming cycle.
	no reaction	After ETS programming, the relay of the output shows no response and remains in the switching state last selected.
		 The parameterized behaviour will be executed after every application or parameter download by the ETS. A simple download of the physical address alone or partial programming of only the group addresses has the effect that this parameter is disregarded and that the parameterized "Behaviour after bus voltage return" will be executed

Behaviour in case of bus
voltage failure

close contact

The actuator permits setting the preferred relay contact position in case of bus voltage failure separately for each output.

open contact

The relay contact is closed on bus voltage failure.

no reaction

The relay contact is opened on bus voltage failure.

In case of bus voltage failure, the relay of the output shows no reaction and remains in the switching state last selected.

Behaviour after bus voltage return		The actuator permits setting the preferred relay contact position after bus voltage return separately for each output.
	close contact	The relay contact is closed after bus voltage return.
	open contact	The relay contact is opened after bus voltage return.
	state as before bus voltage failure	After bus voltage return, the switching state last selected before bus voltage failure and internally stored on bus voltage failure will be retained.
	no reaction	After bus voltage return, the relay of the output shows no reaction and remains in the switching state last selected.
	activate staircase function (if parameterized)	<p>The staircase lighting function is activated after bus voltage return independent of the "Switching" object. For this setting it is indispensable that the staircase lighting function has been programmed and enabled beforehand. When the staircase function has not been enabled, this setting will produce no reaction after return of the bus voltage.</p> <p>i The device adopts the parameterized behaviour only if the last ETS programming of the application or of the parameters ended at least ca. 20 s ago. Otherwise ($T_{ETS} < 20$ s), the "Behaviour after ETS programming" will be adopted also in case of bus voltage return.</p> <p>i The parameterized behaviour will only be adopted, if no forced control is activated after bus voltage return.</p> <p>i The actuator takes its power supply completely from the bus and switches the output relays only after a sufficient amount of energy has been stored. For this reason, there may be a brief delay after a bus voltage return (5 s max.) before the device adopts the parameterized behaviour.</p>

Assignment to central function ?		This parameter determines the assignment of the output to the central function.
	yes (enable central function under "General")	The output is assigned to the central function. The central function is supposed to have been enabled under "General". The assignment has otherwise no effect on the switching output.
	no	The output is not assigned to the central function.
Feedback telegram ?		The current switching state of the output can be reported back separately to the bus.
	none	No feedback object available for the output. Feedback deactivated.
	no inversion, active message object	Feedback and object are activated. The state is transmitted in non-inverted form. The object transmits actively.
	no inversion, passive status object	Feedback and object are activated. The state is transmitted in non-inverted form. The object is passive (telegram transmission only as a response to 'Read' request).
	inversion, active message object	Feedback and object are activated. The state is transmitted in inverted form. The object transmits actively.
	inversion, passive status object	Feedback and object are activated. The state is transmitted in inverted form. The object is passive (telegram transmission only as a response to 'Read' request. i The communication flags of the object are automatically set by the ETS according to the setting.
Time delay for feedback telegram after bus voltage return ?	yes (delay time under "General")	The feedback telegram can be transmitted to the bus with a delay after bus voltage return or after programming with the ETS. Setting "Yes" activates the delay time of the feedback in case of bus voltage return. The delay time is parameterized under "General".
	no	i This parameter is visible as an active message object only if feedback is enabled.

Cyclical transmission of
feedback telegram ?

yes (transm. cyclic and in
case of changes)

The object value of the feedback can be
transmitted cyclically.

The feedback telegram is transmitted to the
bus cyclically and after state changes.
The cycle time is generally programmed
under the "Time settings" entry for all feed-
back telegrams.

**no (transmission only in
case of changes)**

The feedback telegram is transmitted to the
bus only after state changes.

This parameter is visible as an active
message object only if feedback is en-
abled.

 Ax – Enabled functions (x = number of output / All outputs can be parameterized independent of one another.)

Assignment to cyclical monitoring ?

no

This parameter determines the assignment to cyclical monitoring of the output.



Cyclical monitoring deactivated.

yes, "ON" when time has elapsed

Cyclical monitoring activated. The actuator expects a telegram update to the "Switching" object within the monitoring time parameterized under "Time settings". Otherwise, the output will be brought into the predefined contact position and activated when the monitoring time has elapsed.

yes, "OFF" when time has elapsed

Cyclical monitoring activated. The actuator expects a telegram update to the "Switching" object within the monitoring time parameterized under "Time settings". Otherwise, the output will be brought into the predefined contact position and deactivated when the monitoring time has elapsed.

-  An output in preferred contact position is not locked so that new telegram updates to the "Switching" object will again be evaluated and processed normally.
-  The disabling or forced-control position function has a higher priority than the cyclical monitoring function.
-  When cyclical monitoring is activated, it is not possible to program the functions delay times, staircase timer, logic operation and scene.

Time delays

disabled

This parameter can be used to disable or to enable the time delays. When the function is enabled, the corresponding parameters will be displayed under "Ax - Time delays"



enabled



Staircase function

disabled

This parameter can be used to disable or to enable the staircase function. When the function is enabled, the corresponding parameters will be displayed under "Ax - Staircase function" and the necessary object enabled.

enabled

Scene function	disabled enabled	This parameter can be used to disable or to enable the scene function. When the function is enabled, the corresponding parameters will be displayed under "Ax - Scenes" and the necessary object enabled.
Operating hours counter	disabled enabled	This parameter can be used to disable or to enable the operating hours counter. When the function is enabled, the corresponding parameters will be displayed under "Ax - Operating hours counter" and the necessary object enabled.  Disabling of the operating hours counter will cause any operating hours counted beforehand to be deleted and limit or start values set via the object for the output concerned to be reset.
 Ax – Time delays (x = number of output / only visible if parameter "Time delays" under "Ax – Enabled functions" is set to "enabled"!)		
Selection of time delay	no time delay OFF-delay ON-delay ON-delay and OFF-delay	The communication object "Switching" can be evaluated with a time delay. This parameter selects the desired mode of operation of the time delay and enables the other delay parameters.
ON-delay Hours (0...23)	0...23	This parameter is used for programming the duration of the ON-delay Setting the ON-delay hours.
Minutes (0...59)	0...59	Setting the ON-delay minutes.
Seconds (0...59)	0...30...59	Setting the ON-delay seconds. <i>Presetting: 30 seconds</i>
ON-delay retriggerable ?	yes no	An active ON-delay can be retriggered by another "1" telegram (setting "yes"). Alternatively, retriggering can be excluded (setting "no").  The ON-delay parameters are only visible, if the parameter "Selection of time delay" is set to "ON-delay" or to "ON- and OFF-delay".

OFF-delay Hours (0...23)	0...23	This parameter is used for programming the duration of the OFF-delay Setting the OFF-delay hours.
Minutes (0...59)	0...59	Setting the OFF-delay minutes.
Seconds (0...59)	0...30...59	Setting the OFF-delay seconds. <i>Presetting: 30 seconds</i>
OFF-delay retriggerable ?	yes no	An active OFF-delay can be retriggered by another "0" telegram (setting "yes"). Alternatively, retriggering can be excluded (setting "no").  The OFF-delay parameters are only visible, if the parameter "Selection of time delay" is set to "OFF-delay" or to "ON-and OFF-delay".
 Ax – Staircase function (x = number of output / only visible if parameter "Staircase function" under "Ax – Enabled functions" is set to "enabled"!)		
Staircase time Hours (0...23)	0...23	This parameter is used for programming the duration of the staircase lighting time. Setting the staircase lighting time hours.

<p>Activate ON-delay for staircase function ?</p>	<p>yes</p> <p>no</p>	<p>The staircase function permits activating its own ON-delay. This ON-delay function acts on the trigger event of the staircase function and therefore delays switching on.</p> <p>The ON-delay is enabled.</p> <p>The ON-delay is disabled.</p> <p>i The ON-delay parameterized under this item is independent of the other time functions of the actuator. It only acts on the staircase function and not on the "Switching" object.</p>
<p>ON-delay Hours (0...23)</p>	<p>0...23</p>	<p>This parameter is used for programming the duration of the ON-delay</p> <p>Setting the ON-delay hours.</p>
<p>Minutes (0...59)</p>	<p>0...59</p>	<p>Setting the ON-delay minutes.</p>
<p>Seconds (0...59)</p>	<p>0...30...59</p>	<p>Setting the ON-delay seconds.</p> <p><i>Presetting: 30 seconds</i></p>
<p>ON-delay retriggerable ?</p>	<p>yes</p> <p>no</p>	<p>An active ON-delay can be retriggered (setting "yes"). Alternatively, retriggering can be excluded (setting "no").</p> <p>i This parameter is fixed to "no", when the supplementary function "Time extension" is parameterized. In this case, retriggering is not possible.</p> <p>i The ON-delay parameters are only visible, if the parameter "Activate ON-delay for staircase function ?" is set to "yes".</p>
<p>Activate pre-warning time ?</p>	<p>yes</p> <p>no</p>	<p>When the staircase time of a staircase timer function has elapsed, the output can activate the pre-warning function. The pre-warning function is designed to warn a person in the staircase that the lights will go out shortly.</p> <p>The pre-warning function is activated.</p> <p>The pre-warning function is deactivated.</p>

<p>Pre-warning time Minutes (0...59)</p>	<p>0...59</p>	<p>This parameter is used for programming the duration of the pre-warning time. The pre-warning time is added to the staircase lighting time. Pre-warnings (shutting off the output) will be generated only within the pre-warning time.</p> <p>Setting the pre-warning time minutes.</p>
<p>Seconds (0...59)</p>	<p>0...30...59</p>	<p>Setting the pre-warning time seconds.</p> <p><i>Presetting: 30 seconds</i></p> <p>i A pre-warning time is aborted by retriggering of the staircase function.</p>
<p>Number of pre-warnings (1...10)</p>	<p>1...3...10</p>	<p>This parameter defines how often the output is to switch off within the pre-warning time. i.e. how many pre-warnings will be generated.</p>
<p>Time for pre-warning interruptions Seconds (0...59)</p>	<p>0...59</p>	<p>This parameter defines the duration of a pre-warning interruption, i.e. how long the output is to remain off during a pre-warning interruption. The time should be adapted individually to the shut-off behaviour of the lamp type used.</p> <p>Setting the pre-warning interruption seconds.</p>

Milliseconds
(0...9 x 100)



0...5...9

Setting the pre-warning interruption milliseconds.

Presetting: 500 milliseconds



- i** It must be ensured that the "Number of pre-warnings" and the "Time for pre-warning interruptions" are coordinated with the length of the total "pre-warning time". Thus, the total shut-off phase during a pre-warning ("Number of pre-warnings" + "Time for pre-warning interruptions") must not be chosen longer than the pre-warning time itself. Otherwise risk of malfunctions.
- i** The actuator takes its power supply completely from the bus and switches the output relays only after a sufficient amount of energy has been stored. This means that the switching states cannot always be retained because of the simultaneous state changes occurring when pre-warnings are active on several outputs at the same time. In case of simultaneous pre-warnings on several outputs the number of pre-warnings programmed should therefore be kept conveniently small.

 Ax – Scenes (x = number of output / only visible if parameter "Scene function" under "Ax – Enabled functions" is set to "enabled!")

<p>Delay scene recall ?</p>	<p>yes</p> <p>no</p>	<p>A scene is recalled via the scene extension object. If needed, the scene recall on the actuator can be made with a delay after reception of a recall telegram (setting: "yes"). The recall is alternatively made immediately on reception of the telegram (setting: "no").</p> <p> A recall delay has no influence on the storage of scene values.</p>
<p>Delay time Minutes (0...59)</p>	<p>0...59</p>	<p>This parameter is used for programming the duration of delay time</p> <p>Setting the delay time hours.</p>
<p>Seconds (0...59)</p>	<p>0...10...59</p>	<p>Setting the delay time seconds.</p> <p><i>Presetting: 10 seconds</i></p> <p> The parameters are only visible, if the parameter "Delay scene recall ?" is set to "yes".</p>
<p>Overwrite values stored in the device during download ?</p>	<p>yes</p> <p>no</p>	<p>During storage of a scene, the scene values (current states of the outputs concerned) are stored in the device memory. To prevent the stored values from being replaced during ETS programming of the application or of the parameters by the originally programmed scene switching states, the actuator can inhibit overwriting of the scene values (setting: "no"). As an alternative, the original values can be reloaded into the device during each ETS programming (setting: "yes").</p>
<p>Scene X activatable by scene number (scene number "0" = scene de- activated)</p> <p><i>X = depending on the scene (1...8)</i></p>	<p>0...64; 1*</p> <p><i>*: The predefined scene number is dependent on the scene (1...8).</i></p>	<p>The actuator distinguishes between up to 8 different scenes which are recalled via the scene extension object or stored. The datapoint type of the extension object permits addressing of up to 64 scenes max. This parameter defines the scene number (1...64) which is used to address the internal scene.</p> <p>A setting of "0" deactivates the corresponding scene.</p>

Switching state for scene X <i>X = depending on the scene (1...8)</i>	switching on switching off	This parameter is used for programming the switching command which is executed when the scene is recalled.
Storage function for scene X <i>X = depending on the scene (1...8)</i>	yes no	The "yes" setting enables the storage function of the scene. If the function is enabled, the current logic switching state (on / off) can be stored internally via the extension object during reception of a scene storage telegram. If "no" is selected, the storage telegrams are rejected.

 Ax – Operating hours counter (x = number of output / only visible if parameter "Operating hours counter" under "Ax – Enabled functions" is set to "enabled"!)

Type of counter	<p>up-counter</p> <p>down-counter</p>	<p>The operating hours counter can be configured as up counter or down counter. The setting has an influence on the visibility of the other parameters and objects of the operating hours counter.</p>
Limit value preset ?	<p>no</p> <p>yes, as specified in parameter</p> <p>yes, as received via object</p>	<p>If the up counter is used, a limit value can be preset as an option. This parameter defines whether the limit value can be preset in a separate parameter or individually adapted from the bus by an independent communication object. A setting of "no" deactivates the limit value.</p> <p> This parameter is only visible in the configuration "Type of counter = up counter".</p>
Limit value (0...65535 h)	0... 65535	<p>This parameter is used for setting the limit value of the up counter. On reaching this limit value, a "1" telegram is transmitted via the "Runout operating hours counter" object. The counter itself continues to run until the max. count (65535) is reached and stops.</p> <p> This parameter is only visible, if the parameter "Limit value preset ?" is set to "yes, as specified in parameter".</p>
Start value preset ?	<p>no</p> <p>yes, as specified in parameter</p> <p>yes, as received via object</p>	<p>If the down counter is used, a start value can be preset as an option. This parameter defines whether the start value can be preset in a separate parameter or individually adapted from the bus by an independent communication object. A setting of "no" deactivates the start value.</p> <p> This parameter is only visible in the configuration "Type of counter = down counter".</p>

<p>Start value (0...65535 h) 0...65535</p>	<p>This parameter is used for setting the start value of the down counter. After the initialization, the counter begins to decrement the hours from the preset value to "0". After reaching the final value, a "1" telegram is transmitted via the "Runout operating hours counter" object.</p> <p>i This parameter is only visible, if the parameter "Start value preset ?" is set to "yes, as specified in parameter".</p>
<p>Automatic transmission of counting value</p>	<p>The current count of the operating hours counter can be actively transmitted to the bus via the communication object "Operating hours counter value".</p>
<p style="padding-left: 40px;">cyclical transmission</p>	<p>The count is transmitted to the bus cyclically and after a change. The cycle time is programmed under the "Time settings" entry for all outputs in common.</p>
<p style="padding-left: 40px;">after change by interval value</p>	<p>The count is transmitted to the bus only after a change.</p>
<p>Counting value interval (1...65535 h) 1...65535</p>	<p>This parameter is used for setting the counting value interval for automatic transmission. The current count will be transmitted to the bus after the time interval programmed in this parameter.</p> <p>i This parameter is only visible, if the parameter "Automatic transmission of counting value ?" is set to "transmission after change by interval value".</p>

 Ax – Supplementary functions (x = number of output)

<p>Selection of supplementary function</p>	<p>no supplementary function disabling function forced-control position</p>	<p>This parameter can be used to define and to enable the supplementary function. The disabling function can only be parameterized as an alternative to the forced-control position function.</p>
<p>Polarity of disable object</p>	<p>0 = enabled; 1 = disabled 1 = enabled; 0 = disabled</p>	<p>This parameter defines the polarity of the disabling object.</p> <p> After bus voltage return or programming of the application or of the parameters with the ETS, the disabling function is always deactivated (object value "0"). In the inverted setting ("1 = enabled; 0 = disabled"), a "0" telegram update must first be sent after the initialization before the disabled state can be activated.</p>

Behaviour at the beginning of the disabling function

The behaviour of the output at the beginning of the disabling function can be parameterized.

no change of switching state

At the beginning of the disabling function, the relay of the output shows no reaction and remains in the current switching state. Thereafter, the output is locked.

switching off

The output switches off at the beginning of the disabling function and goes into lock.

switching on

The output switches on at the beginning of the disabling function and goes into lock.

blinking

The output blinks on and off during disabling and is locked during this time. The blinking time is generally parameterized for all outputs under "General". During blinking, the logic switching state is "ON - 1".

i Blinking: The actuator takes its power supply completely from the bus and switches the output relays only after a sufficient amount of energy has been stored. In case of blinking with short blinking rate this means that switching states cannot always be tracked because of the simultaneous state changes in several outputs. For this reason, it is important to program sufficiently long blinking rate if several outputs are to blink at the same time.

i An output disabled via the bus can still be operated by hand!

i This parameter is only visible, if the parameter "Selection of supplementary function" is set to "disabling function".

Behaviour at the end of the disabling function:

	The behaviour of the output at the end of the disabling function can be parameterized.
no change of switching state	At the end of disabling, the internal switching state is not changed. Thereafter, the output is again enabled.
switching off	At the end of disabling, the switching state is set to off. The output is re-enabled.
switching on	At the end of disabling, the switching state is set to on. The output is re-enabled.
setting tracked state	At the end of disabling, the last switching state existing before the disabling function or the switching state internally tracked during the disabling function will be set. In this case, residual times of time functions or of the staircase functions will be tracked as well, if they have not completely elapsed at the time of re-enabling the disabling function.
blinking	<p>At the end of disabling, the output blinks on and off and is re-enabled. Blinking persists until a new switching state is set. The blinking time is generally parameterized for all outputs under "General". During blinking, the logic switching state is "ON - 1".</p> <p>i Blinking: The actuator takes its power supply completely from the bus and switches the output relays only after a sufficient amount of energy has been stored. In case of blinking with a short blinking interval this means that switching states cannot always be tracked because of the simultaneous state changes in several outputs. For this reason, it is important to program sufficiently long blinking intervals if <u>several outputs</u> are to blink at the same time.</p> <p>i This parameter is only visible, if the parameter "Selection of supplementary function" is set to "disabling function".</p>

Behaviour at the end of the forced-control position

The behaviour of the output at the beginning of a forced-control position function is directly determined by the forced-position telegram. The behaviour of the output at the end of the forced-control position function can be parameterized.

tracking the switching state

At the end of the forced-control position function, the output will be set to the switching state last existing before forced control or to the one tracked internally while forced control was active. In this case, residual times of time functions or of the staircase functions will be tracked as well, if they have not completely elapsed at the time of re-enabling the disabling function.

no change of switching state

At the end of the forced-control position function, the internal switching state will not be changed. Thereafter, the output is again enabled.

switching off

At the end of the forced-control position function, the switching state is set to off. The output is re-enabled.

switching on

At the end of the forced-control position function, the switching state is set to on. The output is re-enabled.

i This parameter is only visible, if the parameter "Selection of supplementary function" is set to "forced-control position".

Behaviour after bus voltage return

The communication object of the forced-control position function can be initialized after bus voltage return. The switching state of the output can be influenced when the forced-control position function is activated.

no forced-control position

No forced-control position activated after bus voltage return.

activate forced-control position, ON

Forced-control position activated. Output re-enabled.

deactivate forced-control position, OFF

Forced-control position activated. The output will be switched off by forced control.

state of forced-control as before bus voltage failure

The output is set to the forced control state which was stored in a non-volatile memory at the time of bus voltage failure. After programming of the application or of the parameters with the ETS, the value is internally set to "not active".

i After programming of the application or of the parameters with the ETS, the forced-control position is always cancelled.

i This parameter is only visible, if the parameter "Selection of supplementary function" is set to "forced-control position".

Logic operation function ? yes

This parameter can be used to enable the logic operation function (setting "yes"). After enabling, the logic operation object and the parameters of the function are visible.

no

i The parameter is fixed to "no", when the staircase lighting timer or the cyclical monitoring functions are enabled.

<p>Type of logic operation</p>	<p>OR</p> <p>AND</p> <p>AND with feedback</p>	<p>This parameter defines the type of the logic operation.</p> <p>i "AND with feedback:" With a logic object = "0", the output is <u>always</u> "0" (logic AND). In this case, the feedback signal from the output to the "switching" input will directly reset this input when it is being set. Only if the logic operation object = "1", can the output adopt the logic state "1" after a new "1" has been received on the "Switching" input.</p> <p>i This parameter is only visible, if the parameter "Logic operation function ?" is set to "yes".</p>
<p>Value of logic operation object after bus voltage return</p>	<p>0 (OFF)</p> <p>1 (ON)</p>	<p>If logic operation is enabled, the parameter can be used to determine the value with which the logic operation object will be initialized after bus voltage return.</p> <p>i This parameter is only visible, if the parameter "Logic operation function ?" is set to "yes".</p>
<p>Value of logic operation object after ETS download</p>	<p>0 (OFF)</p> <p>1 (ON)</p>	<p>If logic operation is enabled, the parameter can be used to determine the value with which the logic operation object will be initialized after ETS programming.</p> <p>i This parameter is only visible, if the parameter "Logic operation function ?" is set to "yes".</p>

Actuators

Switching 4-gang/8-gang C-load

1



2

	Ref.-No.
KNX switch actuator, C-load	
4-gang, 16 A	2304.16 REG CHM
8-gang, 16 A	2308.16 REG CHM
ETS-product family:	Output
Product type:	4-/8-gang binary output
Series embodiment (SE)-device (4/8 units)	

3

The switching actuator receives telegrams from sensors or other controls via the KNX and switches electrical loads by its independent contacts. Each switching output has a separate bistable relay, the switching state will be kept also at bus voltage drop. By means of the slide switches on top of the device, the relays can be operated by hand in parallel to the KNX without bus voltage or programming.

The C-load actuators offer the same basic functionality as described before for the switching actuators 2304.16 REG HM and 2308.16 REG HM.

Additionally, the C-load actuators offer a current detection function.

The current measurement can be adjusted for each output separately and can either measure the current or monitor the current within adjustable limits.

The measured current can be transmitted to the bus via independent objects (Transmit at changing or cyclically). Alternatively, the connected load can be monitored within predefined limits (by teach-in or by parameter) with separate monitoring telegrams.

4

Technical data

KNX Supply	
Voltage:	21 – 32 V DC (SELV)
Power consumption:	typically 150 mW
Connection:	Bus terminal (KNX Type 5.1)
External supply:	–
Protection:	IP 20
Safety class:	III
Mark of approval:	KNX/VDE
Ambient temperature:	–5°C ... +45°C
Storage/transport temperature:	–25°C ... +70°C (storage above +45°C results in shorter lifetime)
Mounting position:	any, recommended: output terminals on top
Minimum spacings:	none
Fastening:	on DIN rail 35 x 7.5

4 Technical data

Connection:	Screw terminals:	0.5 mm ² to 4 mm ² , solid or finely stranded conductor without wire end sleeve 0.5 mm ² to 2.5 mm ² , finely stranded conductor with wire end sleeve
Total power loss:	Stud torque max. 0.8 Nm 4-gang actuator: max. 4 W 8-gang actuator: max. 8 W	
Behavior at bus voltage drop:	Depending on parameter	
Behavior at bus voltage recovery:	Depending on parameter	
Output		
Number:	4 / 8	
Type:	Potential free, μ -contact, bistable	
Rated voltage:	230 V AC, 50/60 Hz 400 V AC, 50/60 Hz 24 V DC	
Rated current AC:	16 A / AC-1; 10 A / AC-3 at 230 V AC 10 A / AC-1; 6 A / AC-3 at 400 V AC	
Rated current DC:	16 A / 24 V (ohmic)	
Max. switch On current:	600 A, 150 μ s 300 A, 600 μ s	
Min. switch current:	100 mA (at 24 V)	
Current detection		
Signal:	sinus (no detection at DC)	
Signal frequency:	50/60 Hz	
Range:	0.25 ... 16 A effective	
Metering precision (metering tolerance):	at currents ≤ 1 A: ± 100 mA at currents > 1 A: ± 8 % of the actual current value	
Measuring time per output:	min. 700 ms	
Switching Capacities		
HV-halogen:	3680 W	
NV-halogen		
Conventional transformers:	2000 VA	
Tronic transformers:	2500 W	
Fluorescent T5 / T8		
not compensated:	3680 W	
parallel compensated:	2500 W, 200 μ F	
duo-circuit:	3680 W, 200 μ F	
Compact fluorescent		
not compensated:	3680 W	
parallel compensated:	2500 W, 200 μ F	
Mercury-arc lamp		
not compensated:	3680 W	
parallel compensated:	3680 W, 200 μ F	
Ballasts:	The number of ballasts depends on the manufacturer and the type and the quality of the LV-net. The given figures are just examples. (Manufacturer: OSRAM)	
	Max. number per output:	
	T8 Lamps:	
	QTP 3 x 18 W, 4 x 18 W	25
	QTP 2 x 36 W	25
	QTP 1 x 58 W	25
	QTP 2 x 58 W	17
	T5 Lamps:	
	QT-FH 1 x 28 W	25
	QT-FH 2 x 28 W	25
	QT-FH 2 x 54 W	17
	QT-FH 1 x 80 W	17

Notes:

- Different lines can be connected to the device.
- A manual switching by the slide switches is not detected by the software! If a channel is blocked via bus, it can be switched by the slide switch.
- By e.g. a central command or high frequent switching, the relay outputs react with a small time delay.
- Do not connect three phase motors.

4-gang and 8-gang switch actuator 16A C-load SE

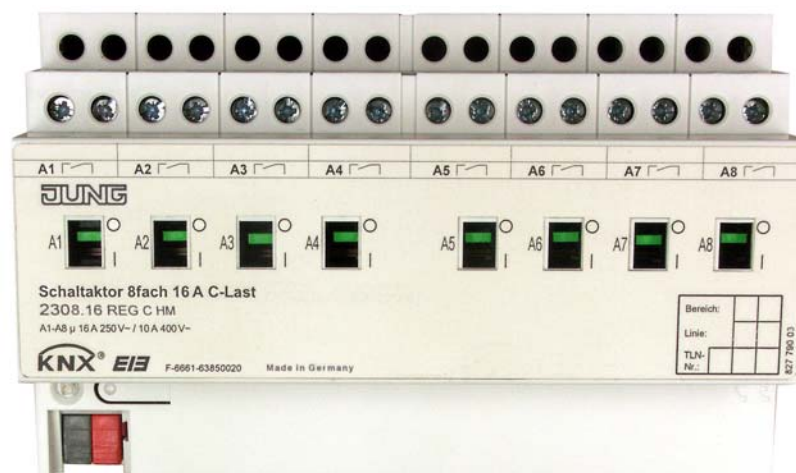

Date of issue: 21.08.2006
230x16REGCHM.doc

Table of Contents

1	<u>Product definition</u>	<u>3</u>
1.1	Product catalogue	3
1.2	Function	3
2	<u>Fitting, electrical connection and operation</u>	<u>4</u>
2.1	Safety instructions.....	4
2.2	Device components.....	5
2.3	Fitting and electrical connection.....	6
2.4	Commissioning.....	8
2.5	Operation	9
3	<u>Technical data.....</u>	<u>10</u>
4	<u>Software information.....</u>	<u>12</u>
4.1	Software specifications	12
4.2	Software "Switching with ack., logic link, time func. 2098x1 / 20A0x1"	13
4.2.1	Scope of functions	13
4.2.2	Software information.....	14
4.2.3	Object table.....	15
4.2.4	Functional description.....	20
4.2.4.1	Description of functions affecting several channels	20
4.2.4.2	Channel-oriented functional description.....	24
4.2.4.3	Delivery state	60
4.2.5	Parameters	61

1 Product definition

1.1 Product catalogue

Product nam: 4-gang switch actuator 16A C-load SE / 8-gang switch actuator 16A C-load SE
Use: actuator
Design: REG (rail-mounted device)
Order no.: 4-gang: 2304.16 REG C HM / 8-gang: 2308.16 REG C HM

1.2 Function

The switching actuator receives telegrams from sensors or other controls via the KNX / EIB and switches electrical consumers by means of its relay contacts which are independent of one another. Each switching output has a separate bistable switching relay so that the states of the switching contacts are safely maintained even in case of bus voltage failure. The switching contacts are especially designed for capacitive loads and therefore suited for relatively high inrush currents (see Technical Data).

With the slide switches on the device front panel, the relays can be switched on and off by hand parallel to the KNX / EIB even without bus voltage or in a non-programmed state. This feature permits fast checking of connected consumers for proper functioning.

The functionalities that can be programmed independently with the ETS for each output channel include among other things extensive timing functions, logic operations, scenes, disabling functions, operating hours counter, cyclical monitoring and an enlarged range of response telegrams. Centralized switching of all outputs is also available. Moreover, the preferred states of the relay contacts in case of bus voltage failure or bus voltage return and after ETS programming can be preset separately. C-load actuators are moreover equipped with a current measurement facility for each output. The load currents detected by the sensing circuit can optionally also be monitored for presettable load limits.

For project design and commissioning of this device it is recommended to use the ETS3.0d. The advantages with regard to downloading (shorter loading times) and parameter programming are available only if this new ETS patch version or later versions are used. For the ETS2 and older versions of the ETS3 a separate product database is available.

The switching actuator is supplied with power from the KNX / EIB and therefore does not need an additional external power supply. The device is designed for rail mounting in closed compact boxes or in power distributions in fixed installations in dry rooms.

2 Fitting, electrical connection and operation

2.1 Safety instructions

Electrical equipment must be installed and fitted only by qualified electricians. Observe the current accident prevention regulations.

Failure to observe any of the installation instructions may cause damage to the device and result in fire and other hazards.

Before working on the device or before replacing any connected loads, disconnect the supply voltage (by cutting out the circuit breaker) to avoid the risk of an electric shock.

The current measurement and the load monitoring functions must not be used for safety-related applications (e.g. overload or residual current detection).

The switching actuator is not suited for safe disconnection of the mains.

Do not connect mains voltage and SELV/PELV circuits to the same switching actuator.

Do not connect three-phase AC motors to the actuator.

Make sure during the installation that there is always sufficient insulation between the mains voltage and the bus. A minimum spacing of 4 mm must be ensured between bus wires and mains conductors.

Do not open the device and do not operate it outside the scope of the technical specifications.

2.2 Device components

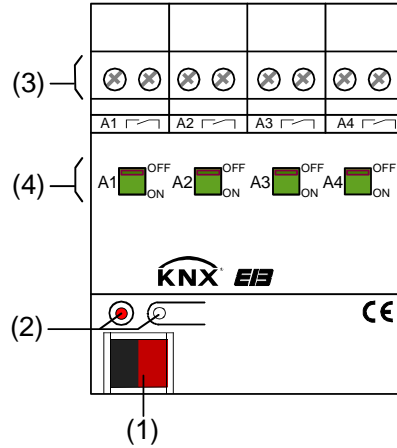

Dimensions:

width (W):
72 mm (4 MW)

height (H):
90 mm

depth (D):
70 mm

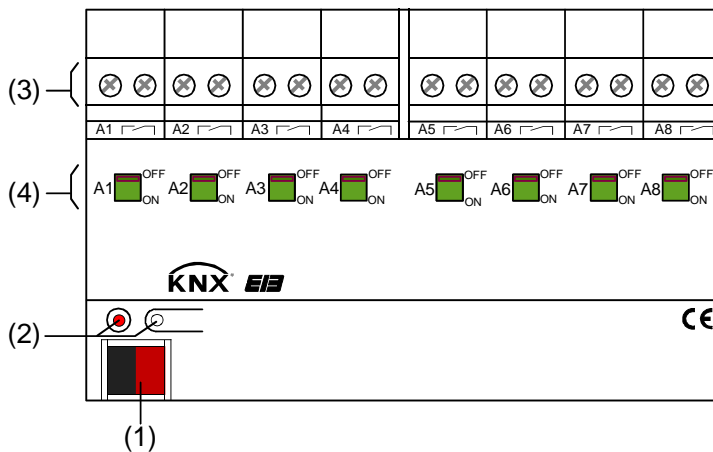

Dimensions:

width (W):
144 mm (8 MW)

height (H):
90 mm

depth (D):
70 mm

- (1): KNX/EIB bus connection
- (2): Programming button and programming LED (red). The programming LED flashes slowly when the safe-state mode is active.
- (3): Screw terminals (Ax,) for connection of different loads (potential-free)
- (4): Slide switches for relay control and for indication of the switching states
 Position 'OFF': contact open
 Position 'ON': contact closed

2.3 Fitting and electrical connection



DANGER!

Electric shock in case of accidental contact with live parts. Electric shocks can be fatal. Before working on the device, cut out the mains supply and cover up live parts in the surroundings.

Fitting

- Fit the device by snapping it onto a mounting rail in acc. with DIN EN 60715. The screw terminals for connection of the load should be at the top.

- ❗ A KNX / EIB data rail is not required.
- ❗ Observe the temperature range (-5 °C ...+45 °C) and ensure sufficient cooling.

Connection

- Connect the loads and the bus line as shown in fig. 1 (connection example).

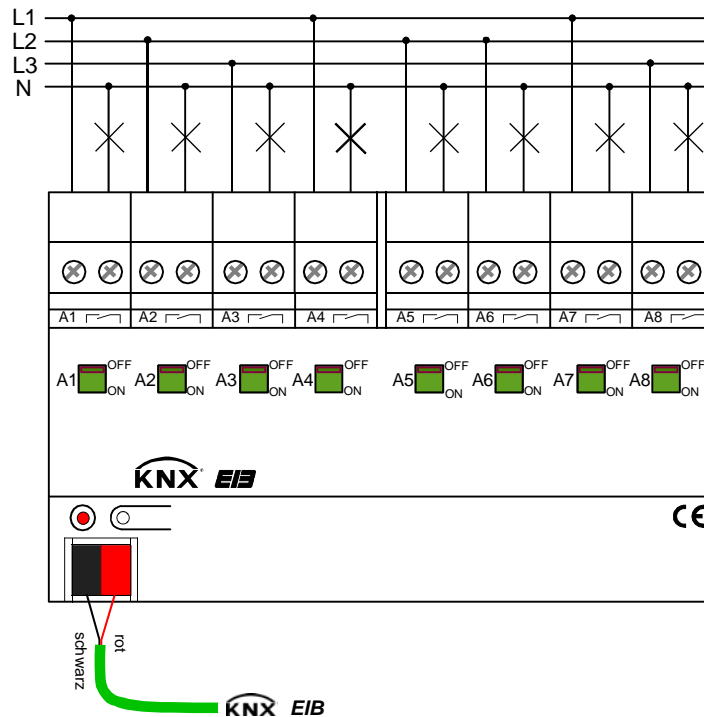

Fig. 1: Electrical connection

- ❗ The relay output contacts of the switching actuator react at brief intervals when actuated or with a slight time delay when actuated by a central control telegram.
- ❗ The device accepts different phase conductors (L1, L2, L3) at the outputs.
- ❗ For current measurements, the device uses contactless current detectors measuring the electromagnetic field of the load current. The actuator is shielded against external magnetic interference fields. Strong magnetic fields in the immediate vicinity of the actuator can nevertheless distort the current measurement. To prevent interference, the supply and return conductors of connected loads should be routed in the distribution as closely to one another as possible. Devices producing magnetic fields (e.g. doorbell transformer, power contactors, etc.) must not be installed in the immediate vicinity of the actuator.
- ❗ Do not connect three-phase AC motors to the actuator.

Installing / removing the protective cap

To protect the bus lines against hazardous voltages, especially in the area of the connecting terminals, a protective cap can be installed.

The bus must be connected with the bus line led out at the rear (bus terminal plugged into device).

- To install the cap: Slide the cap over the bus connecting terminal until it snaps in place (cf. Fig. 2-A).
- To remove the cap: Remove the cap by pressing the sides slightly and by pulling it out to the front (cf. Fig. 2-B).

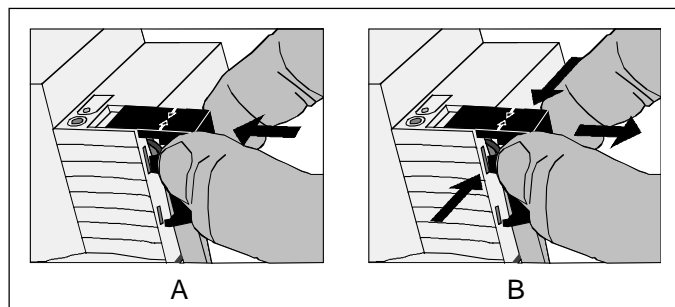

Fig. 2: Installing / removing the protective cap

2.4 Commissioning

After installation of the actuator and connection of the bus line and of all electrical loads, the device can be put into operation. The following procedure is generally recommended...



DANGER!

Electric shock in case of accidental contact with live parts. Electric shocks can be fatal. Before working on the device, cut out the mains supply and cover up live parts in the surroundings.

Putting the device into operation

All loads must have been completely installed and connected.

- Switch on the bus voltage Check: the red programming LED must light up when the programming button is being depressed.
- Download the physical address and the application data with the ETS.
- Switch on the mains voltage supply to the outputs.
The device is now ready for operation.

i The outputs of the actuator can be switched manually even without bus voltage and in the unprogrammed state of the actuator. Due to this feature, the loads connected to the individual outputs can be checked for proper functioning already during site operation.

2.5 Operation

The switching position of the relays is indicated by slide switches on the front panel of the device (cf. Fig. 3). The switches are also provided for manual operation and can be actuated with a suitable tool (e.g. screwdriver).

Manual operation of an output

- Slide the switch into the 'OFF' position
The relay contact is open.
- Slide the switch into the 'ON' position
The relay contact is closed.



Fig. 3: Slide switch for each output with indication of switching position

- i** The position of the slide switch shows directly the switching state of the relay independently of the mode of operation of the output (programming as make or break contact).
- i** Manual switching of the relays is independent of the bus. In case of manual switching there will be no feedback via the bus.
- i** Manual operation of the slide switches does not inhibit operation via the bus. An output last operated by hand can at any time be controlled via the bus.
- i** An output disabled via the bus can nevertheless be operated by hand!

3 Technical data

Type of protection	IP 20
Safety class:	III
Mark of approval:	KNX / EIB / VDE
Ambient temperature:	-5 °C ...+45 °C
Storage / transport temperature:	-25 °C...+70 °C (Storage above + 45 °C reduces the lifetime)
Mounting position:	any position (preferred: output terminals at the top)
Minimum distances:	none
Type of fastening:	Snap-fastening on DIN rail in closed cabinets (e.g. small distributions, etc.) / KNX / EIB data rail not required.
KNX / EIB supply	
Voltage:	21...32 V DC SELV
Power consumption:	typically 150 mW
Connection:	with screw terminals: 0,5...4 mm ² solid and stranded wire without ferrule 0,5...2,5mm ² stranded wire with ferrule Max. tightening torque: 0.8 Nm
External supply	---
Total power loss:	4-channel switching actuator: max. 4 W 8-channel switching actuator: max. 8 W
Response to bus voltage failure:	depending on parameterization cf. chapter 4. "Software description")
Response to bus voltage return:	depending on parameterization cf. chapter 4. "Software description")
Output:	
Number:	4-channel switching actuator: 4 8-channel switching actuator: 8
Type of contact:	potential-free μ -contact, bistable
Switching voltage:	230 V AC; 50 / 60 Hz 400 V AC; 50 / 60 Hz 24 V DC
Switching capacity 230 V AC	16 A / AC 1 10 A / AC 3
Switching capacity 400 V AC	10 A / AC 1 6 A / AC 3
Switching capacity DC	16 A / 24 V (resistive load)
max. Inrush current:	600 A, 150 μ s 300 A, 600 μ s
min. switching current:	100 mA (at 24 V)

Technical data (continued)

Output:

Number:	4-channel switching actuator: 4 8-channel switching actuator: 8
Connection:	with screw terminals: 0.5...4 mm ² solid and stranded wire without ferrule 0.5...2.5 mm ² stranded wire with ferrule Max. tightening torque: 0.8 Nm

Current measurement:

Signal form:	sinusoidal (no DC measurement)
Signal frequency:	50 / 60 Hz
Measuring range:	0.25 ... 16 A rms
Measuring accuracy (measuring tolerance):	for currents < 1 A: ±100 mA for currents > 1 A: ±8 % of current intensity
Measuring time per output:	min. 700 ms

Switching capacity:

Resistive load	3680 W
Capacitive load:	16 A, max. 200 µF

Lamp loads:

Incandescent lamps:	3680 W
HV halogen:	3680 W
LV halogen:	
conventional transformers:	2000 VA
Tronic transformers:	2500 W

Fluorescent lamps T5 / T8

non-compensated	3680 W
parallel compensated:	2500 W, 200 µF
Lead-lag circuit:	3680 W, 200 µF

Compact fluorescent lamps:

non-compensated:	3680 W
parallel compensated:	2500 W, 200 µF

Mercury vapour lamps:

non-compensated:	3680 W
parallel compensated:	3680 W, 200 µF

ELECTRONIC BALLASTS

The number of electronic ballasts that can be connected to the device depends on type and make of the ballast and additionally also on the condition of the low-voltage mains supply network. For this reason, different electronic ballasts are listed below as an example (manufacturer: Osram).

T8 lamps:

QTP 3 x 18 W, 4 x 18 W	25	max. number per output (20.000 switching cycles):
QTP 2 x 36 W	25	
QTP 1 x 58 W	25	
QTP 2 x 58 W	17	

T5 lamps:

QT-FH 1 x 28 W	25
QT-FH 2 x 28 W	25
QT-FQ 2 x 54 W	17
QT-FQ 1 x 80 W	17

4 Software information

4.1 Software specifications

ETS search paths: - Output / Binary output, 4-gang / 4-gang switch actuator 16A C-load SE
 - Output / Binary output, 8-gang / 8-gang switch actuator 16A C-load SE

BAU used: ASIC 1066 + μ C

KNX/EIB type class: 3b - Dev. with cert. PhL + stack

Configuration: S-mode standard

PEI type: "00"_{Hex} / "0"_{Dec}

PEI connector: no connector

Applications for 4-channel switching actuator REG

No.	Summarized description:	Name	Version:	Executable from mask version:
1	Multi-function 4-channel switching with timing functions, logic operations, scenes, disabling functions, operating hours counter, current measurement, cyclical monitoring and an enlarged set of response telegrams. Centralized switching of all outputs is also available. Moreover, the preferred states of the relays in case of bus voltage failure or bus voltage return and after ETS programming can be preset separately.	Switching with ack., logic link, time func. 20A001	0.1 for ETS 2 and ETS 3a...c	705
		Switching with ack., logic link, time func. 20A011	1.1 for ETS3 from version d onwards	

Applications for 8-channel switching actuator REG

No.	Summarized description:	Name	Version:	Executable from mask version:
1	Multi-function 8-channel switching with timing functions, logic operations, scenes, disabling functions, operating hours counter, current measurement, cyclical monitoring and an enlarged set of response telegrams. Centralized switching of all outputs is also available. Moreover, the preferred states of the relays in case of bus voltage failure or bus voltage return and after ETS programming can be preset separately.	Switching with ack., logic link, time func. 209801	0.1 for ETS 2 and ETS 3a...c	705
		Switching with ack., logic link, time func. 209811	1.1 for ETS3 from version d onwards	

4.2 Software "Switching with ack., logic link, time func. 2098x1 / 20A0x1"

4.2.1 Scope of functions

- Each output offers the full scope of functions without any restrictions. All channel-oriented functions can be parameterized separately for each output. This feature permits independent and multi-functional control of the switching outputs.
- Bus-independent manual switching of relays / switching position indication.
- Operation as break or make contacts.
- Central switching function with centralized feedback.
- Switching feedback mode (only with bus operation): active (after changes or cyclical transmission to the bus) or passive (object readout function) feedback function.
- Logic function individual for each output.
- Disabling function parameterizable for each channel. Forced-control position function separately for each output as an alternative.
- Timing functions (ON-delay, OFF-delay, staircase lighting timer, also with early-warning function)
- Incorporation into light-scenes: up to 8 internal scenes parameterizable per output.
- Operating hours counter can be activated independently for each output.
- Separate current measurement per output and transmission of measured current intensity to the bus via independent communication objects (transmission in the event of value changes or additionally in fixed cycles). A load monitoring function (overload / underload) with predefined load limits (teach-in or parameter setting) can be optionally activated with separately parameterizable message telegrams.
- Input monitoring for cyclical updates with safety circuit.
- Behaviour in case of bus voltage failure and bus voltage return as well as after ETS programming presettable for each output.

4.2.2 Software information

ETS project design and commissioning

For project design and commissioning of this device it is recommended to use the ETS3.0d. Advantages with regard to downloading (significantly shorter loading times) and parameter programming can be expected only if this ETS patch version or later versions are used. The advantages consist in using the new mask version 7.5 and the parameter presentation of the ETS3.

The product database required for the ETS3.0d is offered in the *.VD4 format. The corresponding application program is version number "1.1". For the ETS2 and older versions of the ETS3 a separate product database in the *.VD2 format is available. The application program for this ETS version is number "0.1".

As far as the programming scope of functions described in this documentation is concerned, there is no difference between the two application programs.

When older ETS versions are updated to the level of version ETS3.0d or to that of later versions, an additional tool in the form of an ETS add-in is available. This tool is capable of converting older product databases of application version "0.1", for instance from existing ETS2 projects, into the new application format (version "1.1"). This feature permits making use of the advantages of the ETS3.0d application in an easy way and without any changes. The ETS3 add-in can be obtained separately from the manufacturer and is free of charge.

Safe-state mode

If the device - for instance as a result of errors in the project design or during commissioning - does not work properly, the execution of the loaded application program can be halted by activating the safe-state mode. In the safe-state mode, the outputs cannot be controlled via the bus. The actuator remains passive since the application program is not being executed (state-of-execution: terminated). Only the system software is still functional so that the ETS diagnosis functions and also the programming of the device continue to be visible.

Activation of the safe-state mode

The bus voltage is not yet connected.

- Press the programming button and keep it pressed.
- Switch on the bus or mains voltage. Release the programming button only after the programming LED starts flashing slowly.

The safe-state mode is activated. With a new brief press on the programming button, the programming mode can be switched on and off as usual also in the safe-state mode. The programming LED will nevertheless continue to flash independently of the programming mode as long as the safe-state mode is active.

i The safe-state mode can be terminated by switching off the bus voltage or by programming with the ETS.

4.2.3 Object table

Number of communication objects:	4-channel: 66 (max. object number 104 – gaps in between) 8-channel: 130 (max. object number 208 – gaps in between)
Number of addresses (max):	254
Number of assignments (max):	255
Dynamic table management	no
Maximum table length	255

Objects affecting several channels:

Function: Central function

Object	Function	Name	Type	DP type	Flag
□← ₈	Central switching function	All switching outputs	1 bit	1.001	C, W, -, (R) ¹

Description: 1-bit object for central switching of switching outputs assigned. The polarity can be parameterized.

Function: Centralized feedback

Object	Function	Name	Type	DP type	Flag
□← ₉	Centralized feedback	All switching outputs	4 bytes	27.001	C, -, T, R ²

Description: 4-byte object for centralized feedback of all of the actuators switching states.

¹ Every communication object can be read out. For readout, the R-flag must be set.

² Depending on parameterization, feedback objects are either actively transmitting (C-flag set) or passively readable (R-flag set).

Channel-oriented objects:

Function: Output switching

Object	Function	Name	Type	DP type	Flag
<input type="checkbox"/> 10, 36, 62, 88, 114, 140, 166, 192 ³	Switching	Output 1 – 8 ³	1 bit	1.001	C, W, -, (R) ¹

Description: 1-bit object for controlling one output ("1" = on / "0" = off; observe the parameterized operating mode!).

Function: Forced-control position

Object	Function	Name	Type	DP type	Flag
<input type="checkbox"/> 11, 37, 63, 89, 115, 141, 167, 193 ³	Forced-control position	Output 1 – 8 ³	2 bit	2.001	C, W, -, (R) ¹

Description: 2-bit object for forced control of an output. The object state after bus voltage return can be predefined by parameters.

Function: Disabling function

Object	Function	Name	Type	DP type	Flag
<input type="checkbox"/> 12, 38, 64, 90, 116, 142, 168, 194 ³	Disabling	Output 1 – 8 ³	1 bit	1.003	C,W, -, (R) ¹

Description: 1-bit object for disabling of an output (polarity parameterizable).

Function: Logic operation

Object	Function	Name	Type	DP type	Flag
<input type="checkbox"/> 13, 39, 65, 91, 117, 143, 169, 195 ³	Logic operation	Output 1 – 8 ³	1 bit	1.002	C, W, -, (R) ¹

Description: 1-bit object for the input of the logic operation of an output. The object value after bus voltage return or after programming with the ETS can be predefined with parameters.

³ The number of outputs of the communication objects depends on the programmed device (switching actuator 4-channel = 4 outputs or switching actuator 8-channel = 8 outputs).

¹ Every communication object can be read out. For readout, the R-flag must be set.

Function: Staircase function

Object	Function	Name	Type	DP type	Flag
<input type="checkbox"/> 14, 40, 66, 92, 118, 144, 170, 196 ³	Staircase function start/stop	Output 1 – 8 ³	1 Bit	1.010	C,W, -, (R) ¹

Description: 1-bit object for activation or deactivation of the time delay of the staircase function of an output ("1" = on / "0" = off).

Function: Staircase function

Object	Function	Name	Type	DP type	Flag
<input type="checkbox"/> 15, 41, 67, 93, 119, 145, 171, 197 ³	Staircase function factor	Output 1 – 8 ³	1 byte	5.010	C,W, -, (R) ¹

Description: 1-byte object for setting the time factor for the lighting time of the staircase timer function (value range: 0 ... 255).

Function: Scene function

Object	Function	Name	Type	DP type	Flag
<input type="checkbox"/> 16, 42, 68, 94, 120, 146, 172, 198 ³	Scene extension	Output 1 – 8 ³	1 byte	18.001	C,W, -, (R) ¹

Description: 1-byte object for recalling scenes or for storing new scene values.

Function: Switching status feedback

Object	Function	Name	Type	DP type	Flag
<input type="checkbox"/> 18, 44, 70, 96, 122, 148, 174, 200 ³	Switching feedback	Output 1 – 8 ³	1 bit	1.001	C, -, T, R ²

Description: 1-bit object for feedback signalling of the switching state of an output ("1" = on / "0" = off; observe the parameterized mode of operation!)

³ The number of outputs of the communication objects depends on the programmed device (switching actuator 4-channel = 4 outputs or switching actuator 8-channel = 8 outputs).

¹ Each communication object can be read out. For readout, the R-flag must be set.

² Depending on parameterization, feedback objects are either actively transmitting (C-flag set) or passively readable (R-flag set).

Function: Operating hours counter

Object	Function	Name	Type	DP type	Flag
<input type="checkbox"/> 19, 45, 71, 97, 123, 149, 175, 201 ³	Limit value / start value operating hours counter ⁴	Output 1 – 8 ³	2 bytes	7.007	C, W, -, (R) ¹

Description: 2-byte object for external preset of a limit value / start value for the operating hours counter of an output (value range: 0 ... 65535).

Function: Operating hours counter

Object	Function	Name	Type	DP type	Flag
<input type="checkbox"/> 20, 46, 72, 98, 124, 150, 176, 202 ³	New start operating hours counter	Output 1 – 8 ³	1 bit	1.015	C, W, -, (R) ¹

Description: 1-bit object for resetting the operating hours counter of an output ("1" = reset, "0" = no reaction).

Function: Operating hours counter

Object	Function	Name	Type	DP type	Flag
<input type="checkbox"/> 21, 47, 73, 99, 125, 151, 177, 203 ³	Value operating hours counter	Output 1 – 8 ³	2 bytes	7.007	C, -, T, (R) ¹

Description: 2-byte object for transmission or readout of the current count of the operating hours counter. The value of the communication object is not lost after a bus voltage failure and is actively transmitted the bus after bus voltage return or after programming with the ETS. As delivered, this value is "0".

Function: Operating hours counter

Object	Function	Name	Type	DP type	Flag
<input type="checkbox"/> 22, 48, 74, 100, 126, 152, 178, 204 ³	Runout operating hours counter	Output 1 – 8 ³	1 bit	1.002	C, -, T, (R) ¹

Description: 1-bit object for signalling that the operating hours counter has run out (up-counter = limit value reached / down-counter = value "0" reached). In case of signalling, the object value is transmitted to the bus ("1" = message active / "0" = message inactive). The value of the communication object is not lost after a bus voltage failure and is actively transmitted the bus after bus voltage return or after programming with the ETS when the message is active. If not, only the object will be initialized.

⁴ Limit value object or start value object depending on type of counter programmed as operating hours counter.

³ The number of outputs of the communication objects depends on the programmed device (switching actuator 4-channel = 4 outputs or switching actuator 8-channel = 8 outputs).

¹ Each communication object can be read out. For readout, the R-flag must be set.

Function: Current measurement

Object	Function	Name	Type	DP type	Flag
<input type="checkbox"/> 23, 49, 75, 101, 127, 153, 179, 205 ³	Current intensity teach-in	Output 1 – 8 ³	1 bit	1.003	C, W, -, (R) ¹

Description: 1-bit object for teach-in activation via the bus for learning a new current intensity value for load monitoring purposes ("1" = activate teach-in, "0" = no reaction).

Function: Current measurement

Object	Function	Name	Type	DP type	Flag
<input type="checkbox"/> 24, 50, 76, 102, 128, 154, 180, 206 ³	Underload	Output 1 – 8 ³	1 bit	1.002	C, -, T, (R) ¹

Description: 1-bit object for reporting an underload condition during load monitoring to the bus (polarity parameterizable).

Function: Current measurement

Object	Function	Name	Type	DP type	Flag
<input type="checkbox"/> 25, 51, 77, 103, 129, 155, 181, 207 ³	Overload	Output 1 – 8 ³	1 bit	1.002	C, -, T, (R) ¹

Description: 1-bit object for reporting an overload condition during load monitoring to the bus (polarity parameterizable).

Function: Current measurement

Object	Function	Name	Type	DP type	Flag
<input type="checkbox"/> 26, 52, 78, 104, 130, 156, 182, 208 ³	Current intensity value	Output 1 – 8 ³	2 bytes	9.021	C, -, T, R ¹

Description: 1-bit object for transmitting the measured current intensity value (in mA) to the bus. The valid value range is defined by the limits of the current measurement (relay open - output without current: 0 mA / relay closed – output sourcing current: min. 250 mA to typically 16 A – observe measuring tolerance).

¹ Each communication object can be read out. For readout, the R-flag must be set.

³ The number of outputs of the communication objects depends on the programmed device (switching actuator 4-channel = 4 outputs or switching actuator 8-channel = 8 outputs).

4.2.4 Functional description

4.2.4.1 Description of functions affecting several channels

Delay after bus voltage return

To reduce telegram traffic on the bus line after bus voltage activation (bus reset), after connection of the device to the bus line or after programming with the ETS, it is possible to delay all actively transmitted feedback telegrams of the actuator. For this purpose, a delay affecting several channels can be specified (parameter "Delay after bus voltage return" on parameter page "General". Feedback telegrams for bus initialization will therefore be transmitted to the bus only after the parameterized time has elapsed.

Which of the feedback telegrams is actually delayed and which is not can be specified for each output channel and for each feedback function separately.

- The delay has no effect on the behaviour of the outputs. Only the feedback telegrams are delayed. The outputs can also be activated during the delay after bus voltage return.
- Moreover, all actively transmitting objects of the operating hours counter or of the current measurement functions are to be handled as feedback objects as well. In this case, however, all feedback telegrams are always transmitted with a delay depending on the parameter selected under "Delay after bus voltage return".
- A setting of "0" for the delay after bus voltage return deactivates the delaying function altogether. In this case, all feedback telegrams, if actively transmitted, will be transmitted to the bus without any delay.

Central function

The actuator offers the possibility of linking selected individual or all output channels with a 1-bit central communication object. The behaviour in case of activating an output via the central function is comparable to a central group address linked with all "Switching" objects.

The outputs assigned to the central function are activated in accordance with the central object value received. The polarity of the central telegram can, if necessary, be inverted by means of a parameter.

The behaviour of the channels is identical with 'normal' activation via the "Switching" objects (same priority – last switching command is executed – cf. Fig. 4). In this way, all 'secondary' functions such as timing or supplementary functions or logic operations are included as well. The parameterized relay operation is also evaluated for each output separately.

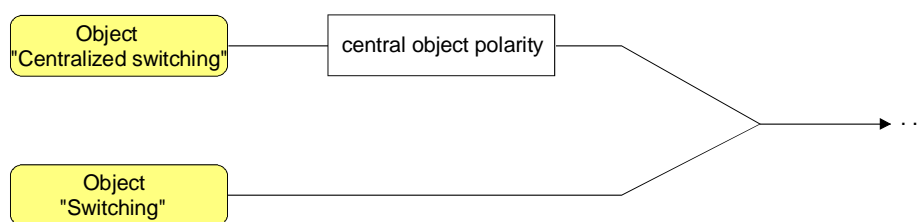

Fig.4: Functional diagram "Centralized switching"

Enabling the central function

- Enable the central function on parameter page "General" by setting the "Central function?" parameter to "Yes".

When the function is activated, the "Centralized switching" communication object is visible.

Assigning outputs to the central function

Each output can be assigned independently to the central function.

The central function must have been enabled on parameter page "General". The assignment has otherwise no effect on the switching output.

- Set the "Assignment to central function" parameter on the "Ax-General" page (x = number of output) to "Yes".

The corresponding output is now assigned to the central function. It can be switched on or off from a central control station.

- ⓘ The switching state set by the central function is tracked in the feedback objects and also transmitted to the bus, if they are actively transmitting. The switching state set by a central function is not tracked in the "Switching" objects.
- ⓘ After a bus voltage return or after programming with the ETS, the central function is always inactive (object value "0").

Centralized feedback

After central commands or after bus voltage return, a bus line is generally heavily loaded by data traffic as many bus devices are transmitting the state of their communication objects by means of feedback telegrams. This effect is particularly remarkable when visualizations are used. To keep the telegram load low during a 'bus initialization', the centralized feedback function of the actuator can be employed. The centralized feedback function groups the switching states of all outputs together in only one telegram. The 32-bit wide communication object "Centralized feedback" contains the feedback information of the individual outputs in a bit-oriented format and is organized as shown Fig. 5.

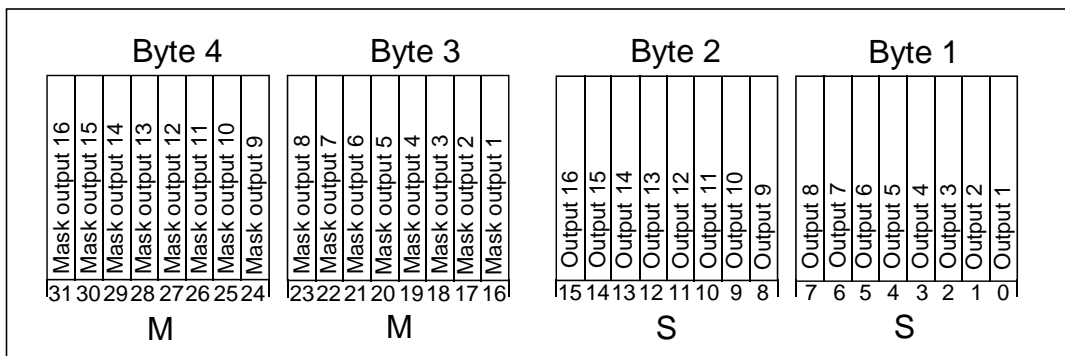

Fig. 5: Structure of the centralized feedback object

The object permits representing up to 16 outputs and thus up to 16 different switching states in a logical format, with each output having one bit representing the switching state ("S" bit) and another one defining the masking ("M" bit). The "S" bits correspond to the logical non-inverted switching states of the outputs and are either "1" (on) or "0" (off). The "M" bits are "1", if there is such an output on the actuator. Likewise, the "M" bits are "0", if there is no corresponding output on the actuator. In the latter case, the pertaining "S" bits are permanently "0" because there is no switching state.

Object value format for 4-channel switching actuator: "00 0F 00 0x", x = switching states,

Object value format for 8-channel switching actuator: "00 FF 00 xx", xx = switching states.

The datapoint type of the centralized feedback is KNX-standardized (DPT 27.001). It could be used in suitable visualization applications, for instance in public buildings like schools or hospitals, where the switching states of all actuators are displayed centrally and not separately at the local control units. In such applications, the centralized feedback can replace the 1-bit single feedback and thus reduce the bus load significantly.

Activating the centralized feedback function

The centralized feedback can be used as an active message object or as a passive status object. As an active message object, the centralized feedback information is transmitted to the bus whenever a switching state changes. On the other hand, no telegram will be transmitted when it is used as a passive status object. In this case, the object value must be read out. The ETS automatically sets the object communication flags required for proper functioning.

- The parameter "Make use of centralized feedback ?" of the required function must be set to "Yes, active message object" or "Yes, passive status object".
The 4-byte communication object "Centralized feedback" is enabled. The object can be used when it has been linked with a group address.

Activating centralized feedback on bus voltage return or after ETS programming

The centralized feedback state is transmitted to the bus after bus voltage return or ETS programming if used as active message object. In this case, the feedback can be delayed with the delay being set globally for all outputs together (cf. "Delay after bus voltage return").

- Set the parameter "Time delay for feedback telegram after bus voltage return" of the centralized feedback to "Yes".
The centralized feedback is transmitted with a delay after bus voltage return or ETS programming. No feedback telegram is transmitted during a running delay, even if a switching state changes during this delay.
- Set the parameter "Time delay for feedback telegram after bus voltage return" of the centralized feedback to "No".
The feedback telegram is transmitted immediately after bus voltage return or ETS programming.

Activating cyclical transmission for centralized feedback telegrams

By means of the actively transmitting signalling object, the centralized feedback telegram can – besides being sent in case of state changes – also be transmitted cyclically.

- Set the parameter "Cyclical transmission of centralized feedback telegram ?" on parameter page "General" to "Yes".
Cyclical transmission is now activated.
 - Set the parameter "Cyclical transmission of centralized feedback telegram ?" on parameter page "General" to "No".
Cyclical transmission is deactivated so that the centralized feedback is transmitted to the bus only when one of the switching states changes.
- i** The cycle time is defined centrally for all cyclical feedback telegrams on the parameter page "Time settings".
- i** No centralized feedback telegram is transmitted during an active delay after bus voltage return, even if a switching state changes during the delay.
- i** A blinking 'output' (cf. "disabling function") will always be reported back as "switched on".
- i** Changes of the switching state made manually are not detected.

4.2.4.2 Channel-oriented functional description

Mode of operation

The relays of a switching output can be parameterized as make or break contacts. This feature offers the possibility of inversion the switching states. The preset mode of operation has consequences for the switching state feedback function.

Setting the mode of operation

The parameter "Mode of operation" exists separately for each output channel on the parameter page "Ax - General" (x = number of output).

- Program the relay contact as "make contact".
Switching state = off ("0") → relay contact open,
Switching state = on ("1") → relay contact closed.
- Program the relay contact as "break contact".
Switching state = off ("0") → relay contact closed,
Switching state = on ("1") → relay contact open.

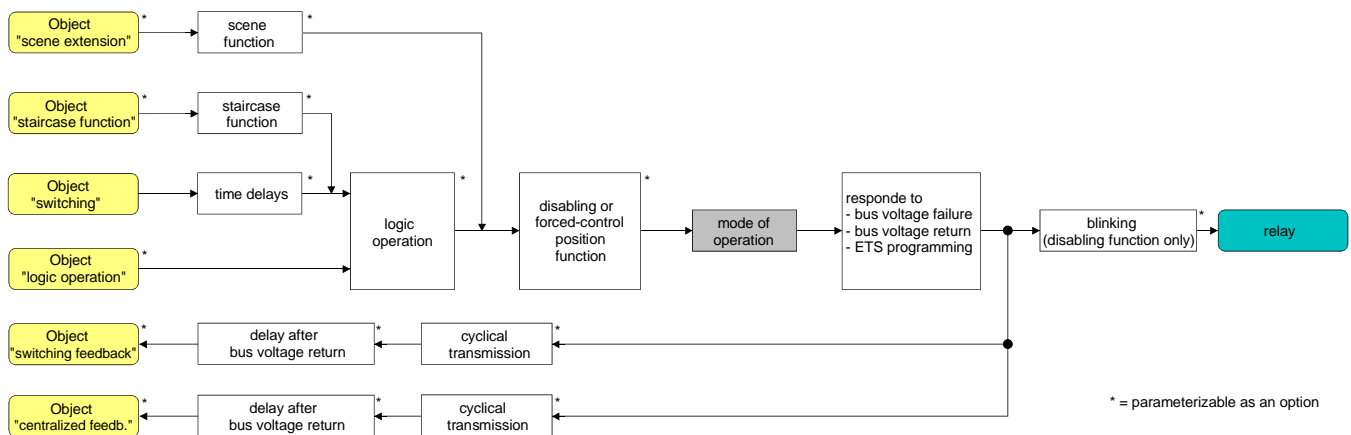

Fig. 6: Functional diagram "Mode of operation"

- ❗ The logic switching state ("on - 1" or "off – 0") is set by the communication object "Switching" and influenced by the functions that can be optionally activated (e.g. timing/staircase functions, logic operations, disabling/forced-control position functions, scenes – cf. Fig. 6).
- ❗ A switching state set after bus voltage return or after ETS programming will be tracked in the feedback object depending on the "Mode of operation" parameter.

Reaction after bus voltage failure / return or after ETS programming

The preferred relay contact positions after bus voltage return or after ETS programming can be preset separately for each output. Since the actuator is equipped with bistable relays, the relay switching state at bus voltage failure can be defined as well.

Presetting the behaviour after ETS programming

The parameter "Behaviour after ETS programming" can be preset separately for each output channel on the parameter page "Ax - General" (x = number of output). This parameter can be used to parameterize the output relay behaviour independent of the behaviour after bus voltage return.

- Set the parameter to "no reaction".
After ETS programming, the relay of the output shows no response and remains in the switching state last selected. The internal logic switching state is not lost either by an ETS programming cycle.
 - Set the parameter to "close contact".
The relay contact is closed after an ETS programming cycle.
 - Set the parameter to "open contact".
The relay contact is opened after an ETS programming cycle.
- i** The parameterized behaviour will be executed after every application or parameter download by the ETS. Downloading only the physical address or programming the group addresses only partially has the effect that this parameter will be disregarded and the parameterized "Behaviour after bus voltage return" be adopted.
- i** A switching state set after an ETS programming cycle will be tracked in the feedback object depending on the "Mode of operation" parameter.

Presetting the behaviour in case of bus voltage failure

The parameter "Behaviour in case of bus voltage failure" can be preset separately for each output channel under "Ax - General" (X = number of output).

- Set the parameter to "no reaction".
In case of bus voltage failure, the relay of the output shows no reaction and remains in the switching state last selected.
- Set the parameter to "close contact".
The relay contact is closed on bus voltage failure.
- Set the parameter to "open contact".
The relay contact is opened on bus voltage failure.

Presetting the reaction after bus voltage return

The parameter "Behaviour after bus voltage return" can be preset separately for each output channel on parameter page "Ax - General" (x = number of output).

- Set the parameter to "close contact".
The relay contact is closed after bus voltage return.
 - Set the parameter to "open contact".
The relay contact is opened after bus voltage return.
 - Set the parameter to "State as before bus voltage failure".
After bus voltage return, the switching state last selected before bus voltage failure and internally stored on bus voltage failure will be tracked.
 - Set the parameter to "no reaction".
After bus voltage return, the relay of the output shows no reaction and remains in the switching state last selected.
 - Set the parameter to "Activate staircase function (if parameterized)".
The staircase function is activated after bus voltage return independent of the "Switching" object. For this setting it is indispensable that the staircase function has been programmed and enabled beforehand. When the staircase function has not been enabled, this setting will produce no reaction after bus voltage return.
- ❗ "No reaction" setting: On return of bus voltage, the switching state will be internally set back to "switched off - 0" independent of the position of the relay contacts. The feedbacks will also be initialized this way, if applicable even in inverted form.
In this case, the switching status returned corresponds to the 'true' relay status only after the outputs have been activated at least once via the bus.
- ❗ The actuator takes its power supply completely from the bus and switches the output relays only after a sufficient amount of energy has been stored. For this reason, there may be a brief delay after a bus voltage return (5 s max.) before the device adopts the parameterized behaviour.
- ❗ The device adopts the parameterized behaviour only if the last ETS programming of the application or of the parameters occurred at least ca. 20 s ago. Otherwise ($T_{ETS} < 20$ s), the "Behaviour after ETS programming" will be adopted even after a return of the bus voltage.
- ❗ The parameterized behaviour will only be adopted, if no forced control is activated after a bus voltage return.
- ❗ A switching state set after a bus voltage return will be tracked in the feedback object depending on the "Mode of operation" parameter.

Switching status feedback

The actuator can return the switching status set at its output ("on" or "off") to the bus (cf. Fig. 7). The returned feedback value can optionally be inverted.

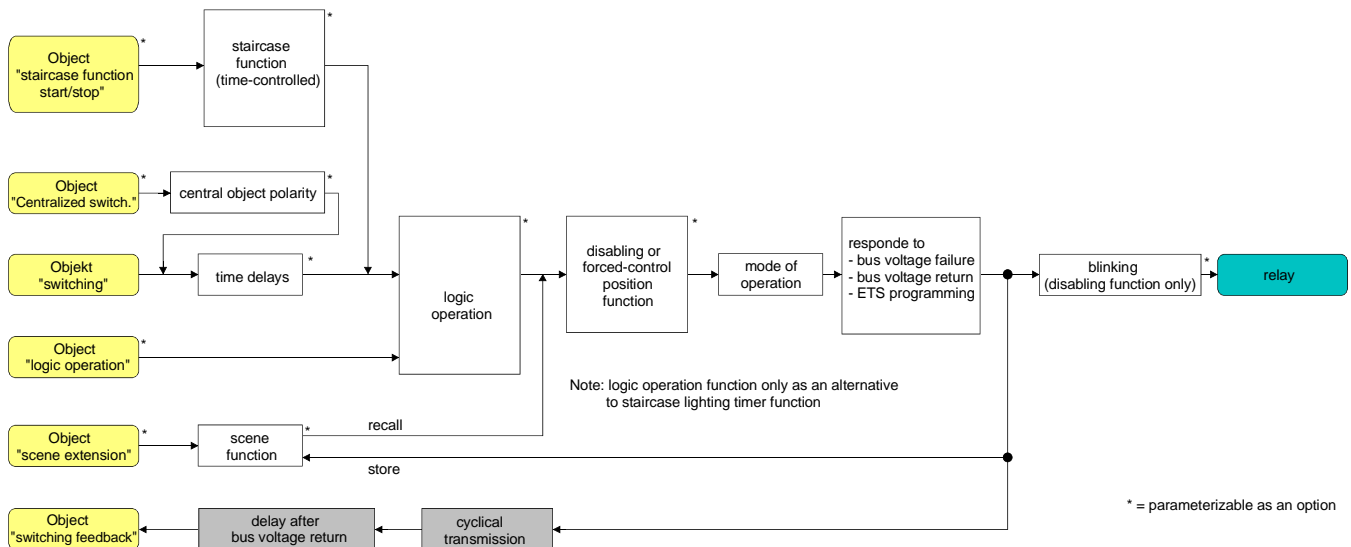

Fig. 7: Functional feedback diagram

Activating the switching status feedback function

The switching status feedback can be used as an active message object or as a passive status object. As an active message object, the switching status feedback information is transmitted to the bus whenever a switching state changes. As a passive status object, there is no telegram transmission after a change. In this case, the object value must be read out. The ETS automatically sets the object communication flags required for proper functioning.

The parameter "Feedback telegram?" can be preset separately for each output channel on the parameter page "Ax - General" (x = number of output).

- Set the parameter to "no inversion, active message object" or to "inversion, active message object".
The feedback object is enabled. Depending on the setting, the switching status is transmitted in non-inverted or in inverted form as soon as a change of state occurs or after the device has been programmed with the ETS. The transmission of telegrams takes place even after return of the bus voltage.
 - Set the parameter to "no inversion, passive status object" or to "inversion, passive status object".
The feedback object is enabled. Depending on the setting, the switching status will be transmitted back in inverted or non-inverted form only if the feedback object is read by the bus. No automatic telegram transmission takes place after bus voltage return or after programming with the ETS.
- i** In case of actively transmitting objects, all status updates from "ON" to "ON" or from "OFF" to "OFF" via the object "Switching" or the object "Central switching" always cause a feedback telegram to be transmitted. If a delay is preset and if the switching state is changed via the object "Switching", the delay period must have elapsed before the feedback will be updated.

- ❗ A 'blinking' output (cf. "Disabling function") will always be reported back as "switched on".
- ❗ Switching state changes by manual operation are not detected.

Activating switching status feedback on return of bus voltage or after programming with the ETS

If used as active message object, the switching status feedback information is transmitted to the bus after bus voltage return or after programming with the ETS. In these cases, the feedback telegram can be time-delayed with the delay being preset globally for all outputs together (cf. "Delay after bus voltage return").

- Set the parameter "Time delay for feedback telegram delay after bus voltage return" on parameter page "Ax - General" (x = number of output) to "Yes".
The switching status telegram will be transmitted with a delay after bus voltage return or after programming with the ETS. No feedback telegram is transmitted during a running delay, even if a switching state changes during this delay.
- Set the parameter "Time delay for feedback telegram delay after bus voltage return" on parameter page "Ax - General" (x = number of output) to "No".
The switching status telegram will be transmitted immediately after bus voltage return or after programming with the ETS.

- ❗ In case of a feedback telegram after bus voltage return or after programming with the ETS, the parameterized mode of operation will be evaluated. Examples for a non-inverted switching status feedback telegram:
Mode of operation make contact: contact closed = feedback "on",
Mode of operation make contact: contact opened = feedback "off",
Mode of operation break contact: contact closed = feedback "off",
Mode of operation break contact: contact opened = feedback "on".

Presetting the cyclical transmission function for the switching status feedback telegram

In addition to being transmitted in case of a state change, the switching status feedback telegram can also be transmitted cyclically via the active message object.

- Set the parameter "Cyclical transmission of feedback telegram?" on parameter page "Ax - General" (x = number of output) to "Yes".
Cyclical transmission is now activated.
 - Set the parameter "Cyclical transmission of feedback telegram?" on parameter page "Ax - General" (x = number of output) to "No".
Cyclical transmission is deactivated which means that a feedback telegram is transmitted to the bus only if one of the switching states changes.
- ❗ The cycle time is defined centrally for all cyclical feedback telegrams on the parameter page "Time settings"
 - ❗ During an active delay after bus voltage return no feedback telegram will be transmitted even if a switching state changes.

Cyclical monitoring

The actuator offers the possibility of monitoring specific outputs or all outputs for the arrival of switching telegrams. This feature can be used to monitor such objects that have to be updated cyclically by the bus, for instance, by means of actuating variable telegrams from room temperature controllers. The polarity of the telegram update ("0" or "1") is of no importance in this case.

If the monitored objects are not updated within a fixed parameterized monitoring period, the outputs concerned will adopt their predefined preferred state. This does not mean, however, that the outputs are disabled, but rather that they will be set to the new switching state after reception of another switching telegram.

The monitoring time is preset globally for all outputs together with the "Time for cyclical monitoring" parameter on the "Time settings" parameter page. Each output has its own time control so that the parameterized monitoring time will be evaluated independent of the channel.

The time is restarted for an output (cf. Fig. 8) after each reception of a switching telegram via the objects "Switching" or "Central switching" (if a central function has been activated for the output concerned). The monitoring time is restarted automatically also after bus voltage return or after programming with the ETS.

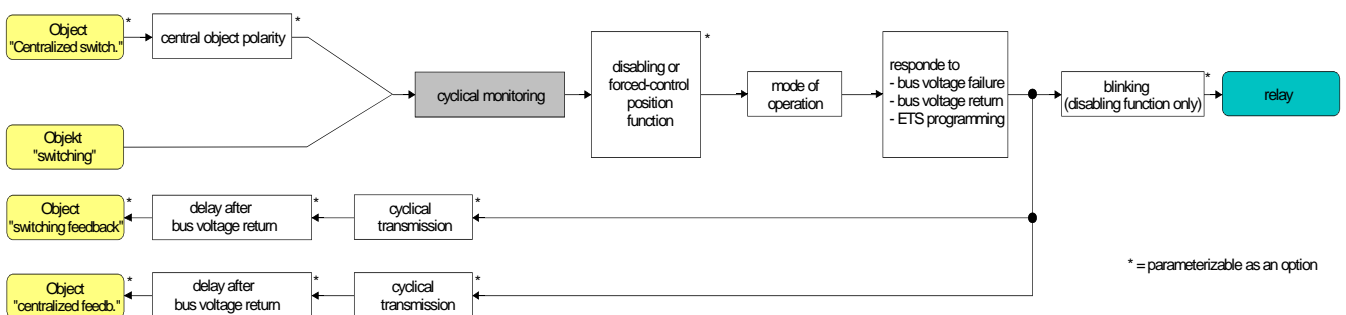

Fig. 8: Functional diagram of cyclical monitoring function

Activating the cyclical monitoring function

The cyclical monitoring function can be activated separately for each output with the parameter "Assignment to cyclical monitoring ?" on parameter page "Ax – Enabled functions" (x = number of output). When the monitoring time elapses without receiving a telegram update while the function is active, the actuator sets the output to the preferred state when the time ends.

- Set the parameter to "Yes, "ON" when time has elapsed".
The cyclical monitoring function is now activated. The output will be switched on at the end of the time.
 - Set the parameter to "Yes, "OFF" when time has elapsed".
The cyclical monitoring function is now activated. The output will be switched off at the end of the time.
- ⓘ When the cyclical monitoring function is active, the following functions cannot be parameterized: time delays, staircase function, logical operation and scene.
- ⓘ If an output is already in its preferred state when the monitoring time elapses, there will be no reaction and no transmission of a feedback telegram.
- ⓘ The disabling or forced-control position function has a higher priority than the cyclical monitoring function.

Time delays

Up to two time functions can be preset independently for each output. The time functions act only on the communication objects "Switching" or "Central switching" (if a central has been activated for the output in question) and delay the received object value as a function of telegram polarity (cf. Fig. 9).

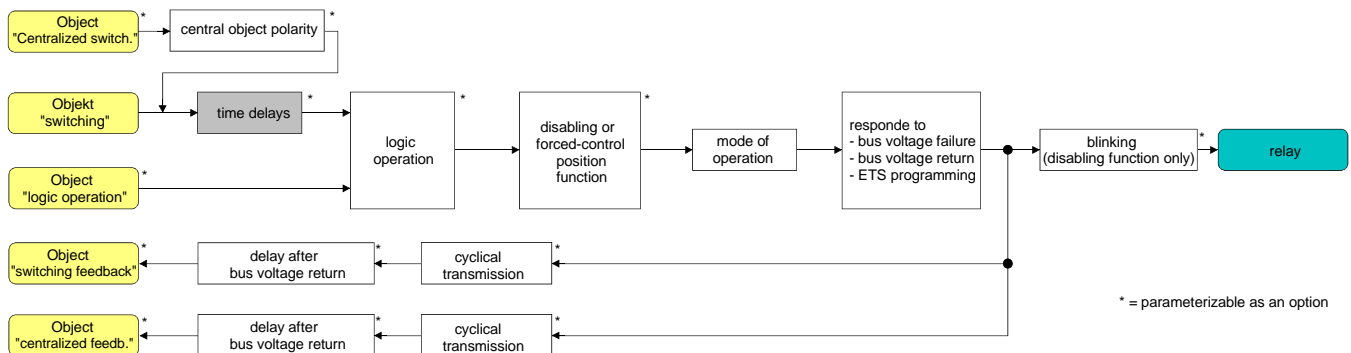

Fig.9: Functional diagram of the time delays

Activating an ON-delay

The time delays must have been enabled on parameter page "Ax – Enabled functions (x = number of output).

- Set the parameter "Selection of time delay" on parameter page "Ax – Time delays" to "ON-delay" or to "ON-delay and OFF delay".

The ON-delay is now enabled and the desired ON-delay time can be preset. After reception of an ON telegram, a parameterized time is started. A subsequent ON-telegram retriggers the time only if the parameter "ON-delay retriggerable ?" has been set to "Yes". The logical switching state will then be transferred to the following functions (e.g. logical operation, disabling / forced-control position function) and the output switched on, only after the ON-delay has elapsed. An OFF-telegram received during the ON-delay will end the delay. The logical switching state corresponds in this case to "switched off".

Activating an OFF-delay

The time delays must have been enabled on parameter page "Ax – Enabled functions (x = number of output).

- Set the parameter "Selection of time delay" on parameter page "Ax – Time delays" to "OFF-delay" or to "ON-delay and OFF delay".

The OFF-delay is now enabled and the desired OFF-delay time can be preset. After reception of an OFF-telegram, a parameterized time is started. A subsequent OFF-telegram retriggers the time only if the parameter "OFF-delay retriggerable ?" has been set to "Yes". The logical switching state will then be transferred to the following functions (e.g. logical operation, disabling / forced-control position function) and the output switched off, only after the OFF-delay has elapsed. An ON-telegram received during the OFF-delay will end the delay. The logical switching state corresponds in this case to "switched on".

- ❶ Feedback: If a time delay has been preset and if the switching state is changed via the "Switching" object, the time delay must have elapsed before feedback telegrams will be transmitted. Updates of the object from "ON" to "ON" or from "OFF" to "OFF" by retriggering during a running time delay has no influence on the switching status feedback.
- ❶ At the end of a disabling or forced-control position function, the state received during or set before the function can be tracked. Residual times of time functions are tracked, if they have not completely elapsed at the time the disabling or forced-control position functions are disabled. In case of a logical operation function, a switching state newly received via the "Switching" object will be executed with a time delay as well.
- ❶ The time delays have no influence on the staircase functions, if these are enabled.
- ❶ A time delay in progress will be completely terminated by a reset of the actuator (bus voltage failure or ETS programming)

Staircase function

The staircase function can be parameterized for each output separately and used for realizing time-controlled staircase lighting or functionally similar applications. The staircase function must have been enabled on parameter page "Ax – Enabled functions" separately for each output before the required communication objects and parameters (on parameter page "Ax – Staircase function") are visible.

The staircase function is controlled by means of the "Staircase function start / stop" communication object and is independent of the "Switching" object of the output (cf. Fig. 10). This feature permits 'parallel operation' of time and normal control, with always the last command being executed.

A telegram to the "Switching" object or a scene recall during an active staircase function ends the staircase time prematurely and sets the output to the switching state corresponding to the object value (time delays taken into account) or the scene value received. Similarly, the switching state of the "Switching" object or a scene recall can be overridden by a staircase timer function.

In combination with a disabling function a time-independent permanent lighting function can also be realized (cf. "Disabling function").

As can be seen from the functional diagram, the staircase function can also be combined with other output functions. The combination with the logic function is, however, not available.

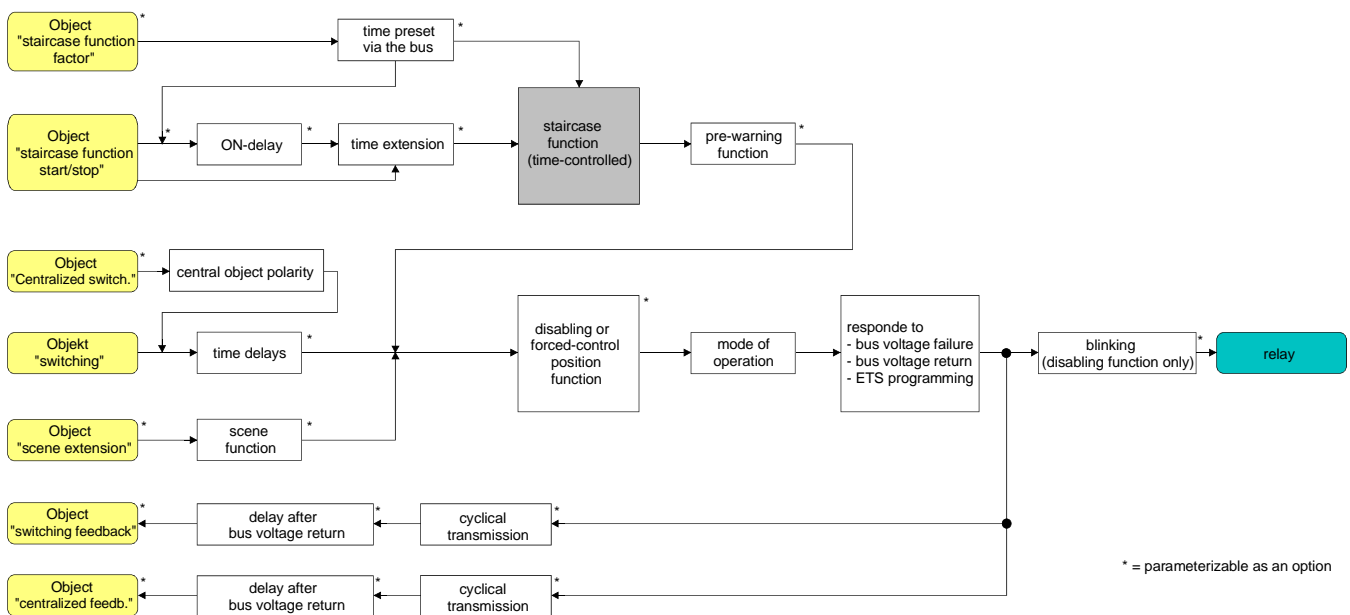

Fig. 10: Functional diagram of the staircase function

The staircase function can be enlarged by a supplementary function with the possibility of activating a time extension. By means of the object "Staircase function start / stop", the "time extension" permits retriggering an activated staircase time n times. As an alternative, "Time preset via the bus" can be selected. With this supplementary function, the parameterized staircase time can be multiplied with a factor received from the bus and thus dynamically adapted.

The staircase function can moreover be enlarged by a separate ON-delay and by a pre-warning function. In acc. with DIN 18015-2, the pre-warning function is designed to warn a person in the staircase that the lights will go out shortly.

Defining the switch-on behaviour of the staircase function

An ON-telegram to the "Staircase function start / stop" activates the staircase lighting time (T_{ON}) the duration of which is defined by the parameter "Staircase time". In addition, an ON-delay (T_{delay}) can be activated (cf. "Presetting the ON-delay for the staircase function"). At the end of the staircase lighting time, the output switches off or optionally activates the pre-warning time ($T_{pre-warn}$) of the pre-warning function (cf. Presetting the pre-warning function of the staircase function). With a possible ON-delay and a pre-warning function, the staircase function has the switch-on behaviour as shown in Fig. 11.

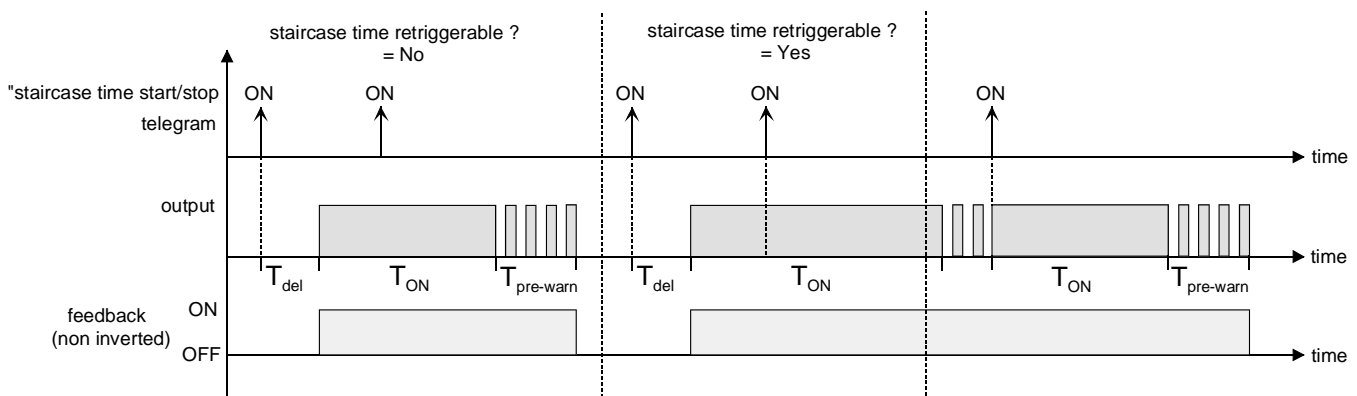

Fig. 11: Switch-on behaviour of the staircase function

The parameter "Staircase time retriggerable ?" defines whether the staircase lighting time can be retriggered or not.

The staircase function must have been enabled on parameter page "Ax – Enabled functions (x = number of output).

- Set the parameter "Staircase time retriggerable ?" to "Yes".
Every ON-telegram received during the ON-phase of the staircase lighting time retriggeres the staircase time completely.
 - Set the parameter "Staircase time retriggerable ?" to "No".
ON-telegrams received during the ON-phase of the staircase time will be rejected. The staircase lighting time will not be retriggered.
- ⓘ An ON-telegram received during the pre-warning time always retriggeres the staircase lighting time independent of the "Staircase time retriggerable ?" parameter.
- ⓘ If the supplementary function "Time extension" is active, the "Staircase time retriggerable ?" parameter cannot be changed. In this case, the parameter is set to "No" and cannot be changed.

Defining the switch-off behaviour of the staircase function

In a staircase function, the reaction to an OFF-telegram to the "Staircase function start / stop" object can also be parameterized. Without reception of an OFF-telegram, the output switches off after the pre-warning time has elapsed. With a possible ON-delay and a pre-warning function, the staircase function has a switch-off behaviour as shown in Fig. 12.

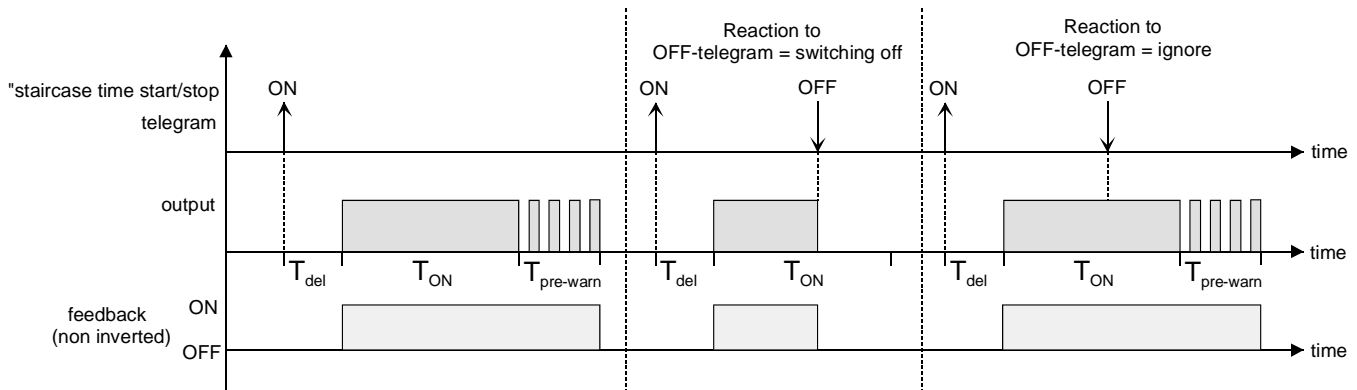

Fig. 12: Switch-off behaviour of the staircase function

The parameter "Reaction to OFF-telegram" defines whether the staircase time (T_{ON}) of the staircase function can be stopped prematurely.

The staircase function must have been enabled on parameter page "Ax – Enabled functions (x = number of output).

- Set the parameter "Reaction to OFF-telegram" to "Switching off"
The output shuts off immediately when an OFF-telegram is received via the object "Staircase function start / stop" during the ON-phase of the staircase time. If the staircase time is stopped prematurely by such a telegram, there is no pre-warning, i.e. the pre-warning time is not started.
 - Set the parameter "Reaction to OFF-telegram" to "Ignore".
OFF-telegrams received during the ON-phase of the staircase time will be rejected. The staircase time will be executed completely, if applicable with a pre-warning.
- i** In the supplementary function "Time preset via the bus", the staircase time of the staircase function can also be started by the reception of a new time factor (cf. "Supplementary function of the staircase function – time preset via bus"). A factor of "0" received in this case will be interpreted as an OFF-telegram. The parameter "Reaction to OFF-telegram" is evaluated in this case, too, so that a staircase time can be terminated prematurely.

Presetting the ON-delay for the staircase function

An ON-telegram to activate the staircase function can also be evaluated with a time delay. This ON-delay can be activated separately for the staircase function and has no influence on the parameterizable time delays for the "Switching" object.

The staircase function must have been enabled on parameter page "Ax – Enabled functions (x = number of output).

- Set the parameter "Activate ON-delay for staircase function ?" on parameter page "Ax – Staircase function" to "Yes".

The ON-delay for the staircase function is now enabled and the desired ON-delay time can be preset. The ON-delay is started after reception of an ON-telegram to the "Staircase function start / stop" object. A subsequent ON-telegram retriggers the time only if the parameter "ON-delay retriggerable ?" has been set to "Yes". The staircase time is activated and the output switched on only after the time delay has elapsed.

- ❗ An OFF telegram via the "Staircase function start / stop" object during the ON-delay ends the delay only if the parameter "Reaction to OFF telegram" is set to "switching off". Otherwise the OFF telegram will be ignored.
- ❗ If the supplementary function "Time extension" is set, the "On-delay retriggerable ?" parameter cannot be changed. In this case, the parameter is set to "No" and cannot be changed.

Presetting the pre-warning function of the staircase function

The pre-warning function complies with DIN 18015-2 and is designed to warn a person in the staircase that the lights will go out shortly. As a pre-warning, the lamps connected to the output are switched off several times for a short instant before the output is shut off definitely. The pre-warning time ($T_{\text{pre-warn}}$), the duration of the interruptions during the pre-warning ($T_{\text{interrupt}}$) and the number of pre-warning interruptions can be parameterized (cf. Fig. 13 - example). The pre-warning time is added to the staircase lighting time (T_{ON}). The pre-warning time has an influence on the value of the feedback object so that the value "0" (non-inverted transmission) is tracked in the feedback object only after the pre-warning time has elapsed.

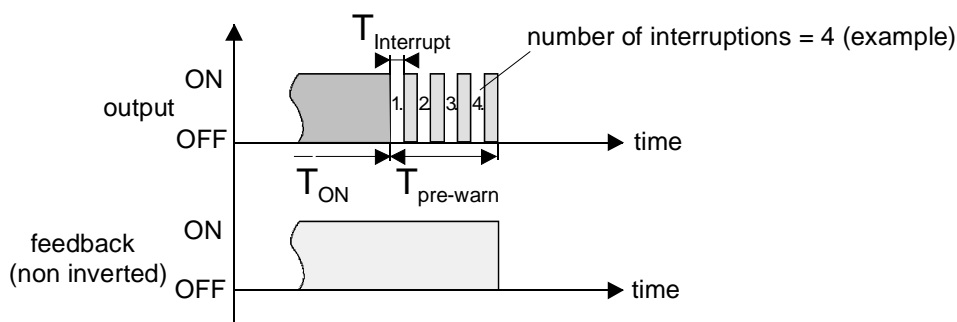

Fig.13: The pre-warning function of the staircase function

The staircase function must have been enabled on parameter page "Ax – Enabled functions (x = number of output).

- Set the parameter "Activate pre-warning time ?" on parameter page "Ax – Staircase function" to "Yes".

The pre-warning function is now enabled and the desired pre-warning time ($T_{\text{pre-warn}}$) can be preset.
 - Set the parameter "Number of pre-warnings" on parameter page "Ax – Staircase function" to the desired value (1...10).

The lamps connected to the output will then be switched off exactly as many times as programmed in this parameter. The 1st pre-warning is always executed at the beginning of the total pre-warning time.
 - Set the parameter "Time for pre-warning interruptions" on parameter page "Ax – Staircase function" to the desired value.

An interruption ($T_{\text{interrupt}}$) during the pre-warning time is as long as programmed in this parameter. A presettable interruption time permits adapting the shut-off phase of the lighting individually to the lamp type used.
- ⓘ It must be ensured that the "Number of pre-warnings" and the "Time for pre-warning interruptions" are coordinated with the length of the total "pre-warning time". Thus, the total shut-off phase during a pre-warning ("Number of pre-warnings" + "Time for pre-warning interruptions") must not be chosen longer than the pre-warning time itself. Otherwise risk of malfunctions.
- ⓘ The actuator takes its power supply completely from the bus and switches the output relays only after a sufficient amount of energy has been stored. This means that the switching states cannot always be tracked because of the simultaneous state changes occurring when pre-warnings are active on several outputs at the same time. In case of simultaneous pre-warnings on several outputs the number of pre-warnings programmed should therefore be kept conveniently small.
- ⓘ With an ON-telegram to the "Staircase function start / stop" object during an active pre-warning function, the pre-warning time is stopped and the staircase time always restarted (independent of the "Staircase time retriggerable ?" parameter). The parameter "Reaction to OFF-telegram" is also evaluated during the pre-warning time so that an active pre-warning can be terminated prematurely by switching off.

Presetting the staircase lighting timer supplementary function "Time extension"

With the time extension function, the staircase time can be retriggered several times (i.e. extended) via the "Staircase function start/stop" object. The duration of the extension is defined by repeated operation of a control device (several ON-telegrams in succession). The parameterized staircase time can thus be extended by the parameterized factor (max. 5-gang). The extension is then always automatically added to the end of a simple staircase time (T_{ON}) (cf. Fig. 14).

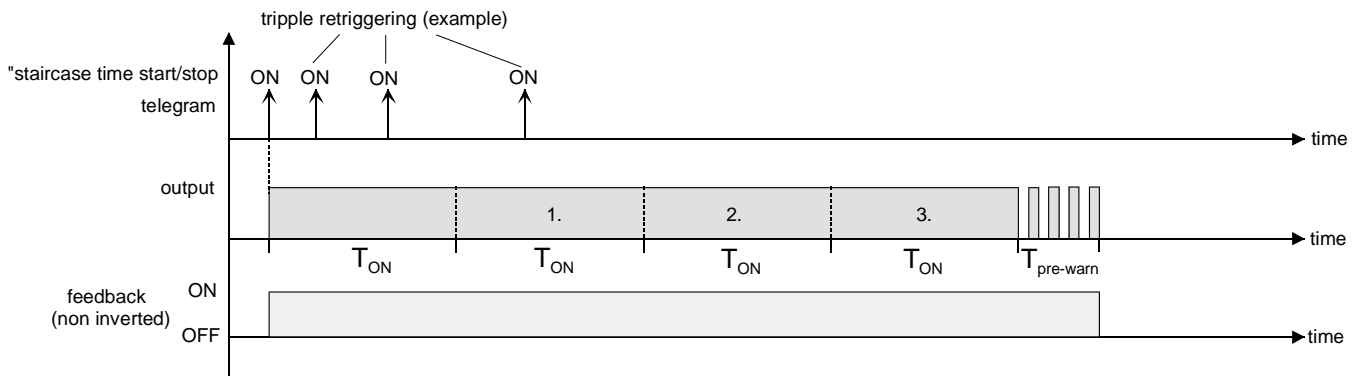

Fig. 14: Time extension for staircase lighting function

With this function, the lighting time in a staircase can be extended (e.g. by a person after shopping) by a defined length without having to retrigger the lighting every time the lighting shuts off automatically. The staircase function must have been enabled on parameter page "Ax – Enabled functions (x = number of output).

- Set the parameter "Supplementary function for staircase function" on parameter page "Ax – Staircase function" to "Time extension" and select the desired factor in the "Maximum time extension" parameter.

On reception of an ON-telegram to the "Staircase function start/stop" object, the staircase time is retriggered at the end of the ON-time as often as determined by the number of telegrams received, however, no longer as permitted by the parameterized factor.

Thus, the setting "3-gang" means that the started staircase time can be automatically retriggered at maximum three more times after elapsing. This means that the time corresponds to 4 times the basic time (cf. Fig. 14).

- ❗ Triggering of an extension can occur during the whole staircase time (T_{ON}). There is no restriction as to the time between two telegrams triggering an extension. Time extension telegrams are evaluated only during the staircase time. An ON-telegram during the pre-warning time triggers the staircase time like in a new start making another time extension possible. If an ON-delay has been programmed, the time extension request is evaluated already during the ON-delay.
- ❗ If a time extension has been parameterized as supplementary function, the parameters "Staircase time retriggerable?" and "ON-delay retriggerable?" are fixed to "No" since retriggering is effected by the time extension.

Presetting the staircase lighting timer supplementary function "Time preset via the bus"

With the time preset via the bus function, the parameterized staircase time can be multiplied with an 8-bit factor received from the bus and thus dynamically adapted. In this setting, the factor is derived from the "Staircase function factor" object. The factor for setting the staircase time lies in a range between 1...255.

The overall staircase time is the product of the factor (object value) and the base (parameterized staircase time) as follows...

Staircase time = (staircase time object value) x (staircase time parameter)

Example:

object value "Staircase function factor" = 5; parameter "Staircase time" = 10s.

→ staircase time selected = 5 x 10s = 50 s.

As an alternative, it is possible to define in the parameters of the staircase function whether the reception of a new factor starts at the same also the staircase time of the staircase function. In this case, the "Staircase function start/stop" object is not existing and starting and stopping is controlled by the factor value received.

The staircase function must have been enabled on parameter page "Ax – Enabled functions (x = number of output).

- Set the parameter "Supplementary function for staircase function" on parameter page "Ax – Staircase function" to "Time preset via the bus" and the parameter "Staircase function activatable via object 'Staircase function factor' ?" to "No".

The staircase time can be adapted dynamically by means of the "Staircase function factor" object. A value of "0" is interpreted as a value of "1". Starting and stopping of the staircase function is effected exclusively via the "Staircase function start/stop" object.

- Set the parameter "Supplementary function for staircase function" on parameter page "Ax – Staircase function" to "Time preset via the bus" and the parameter "Staircase function activatable via object 'Staircase function factor' ?" to "Yes".

The staircase time can be adapted dynamically by means of the "Staircase function factor" object. In addition, the staircase function is started on reception of a new factor with the new staircase lighting time (the "Staircase function start/stop" object is not existing. A factor value of "0" is interpreted as an OFF-telegram with the parameterized reaction to an OFF-telegram being evaluated in this case, too.

A large staircase with several floors is a good example for a possible application of the 'time preset via the bus' function with automatic starting of the staircase lighting time. A touch sensor on each floor of the house transmits a factor value to the staircase function. The higher the floor, the greater the transmitted factor value in order to ensure that the lights remain on longer when it takes more time to reach the upper floors. When a person enters the staircase of the house and after pressing of the touch sensor key, the staircase lighting time is now dynamically adapted and the lighting switched on at the same time.

- ❏ The staircase function is started with the reception of a new factor: A factor of > 0 received during the pre-warning time always retrigger the staircase lighting time independent of the "Staircase time retriggerable ?" parameter.
- ❏ After a reset (bus voltage return or programming with the ETS), the "Staircase function factor" object is always initialized with a "1". This alone is not sufficient for automatic starting of the staircase function (cf. "Presetting the behaviour of the staircase function after bus voltage return").
- ❏ The two supplementary functions "Time extension" and "Time preset via the bus" can now be parameterized as an alternative for one another.

Presetting the behaviour of the staircase function after bus voltage return

The staircase function can optionally be started automatically after bus voltage return.

The staircase function must have been enabled on parameter page "Ax – Enabled functions (x = number of output).

- Set the parameter "Behaviour after bus voltage return" on parameter page "Ax – General" to "Activate staircase function".

The staircase lighting time of the staircase function is started immediately after bus voltage return.

- ⓘ For this setting it is indispensable that the staircase function has been programmed and enabled beforehand. When the staircase function has not been enabled, this setting will produce no reaction after return of the bus voltage.
- ⓘ During an automatic start of the staircase function after return of the bus voltage, an ON-delay – even if parameterized in the staircase function – will not be started.
- ⓘ The actuator takes its power supply completely from the bus and switches the output relays only after a sufficient amount of energy has been stored. For this reason, there may be a brief delay after a bus voltage return (5 s max.) before the device adopts the parameterized behaviour.
- ⓘ The device adopts the parameterized behaviour only if the last ETS programming of the application or of the parameters occurred at least ca. 20 s ago. Otherwise ($T_{ETS} < 20$ s), the "Behaviour after ETS programming" will be adopted even after a return of bus voltage.
- ⓘ The parameterized behaviour will only be adopted, if no forced control is activated after a bus voltage return.
- ⓘ A switching state set after bus voltage return will be tracked in the feedback object as provided for in the "Mode of operation" parameter.

Scene function

Up to 8 scenes can be generated and the corresponding scene values stored in the actuator separately for each output. The scene values are recalled or stored via a separate scene extension object by means of extension telegrams. The datapoint type of the extension object permits addressing of up to 64 scenes max. For this reason, the scene number (1...64) with which the internal scene (1...8) is addressed can be determined in the parameterization of a scene.

The scene function must have been enabled on parameter page "Ax – Enabled functions" separately for each output before the required communication objects and parameters (on parameter page "Ax – Scenes") are visible.

The scene function can be combined with other functions of the output (cf. Fig. 15) with the command last received or selected always being executed:

A telegram to the "Switching" object or a scene recall or a scene storage telegram during an active staircase function ends the staircase lighting time prematurely and sets the output to the switching state corresponding to the object value (time delays taken into account) or the scene value received. Similarly, the output switching state set by the "Switching" object or a scene recall can be overridden by a staircase function or by the result of a logic function.

A combination of the function with cyclical monitoring is not possible.

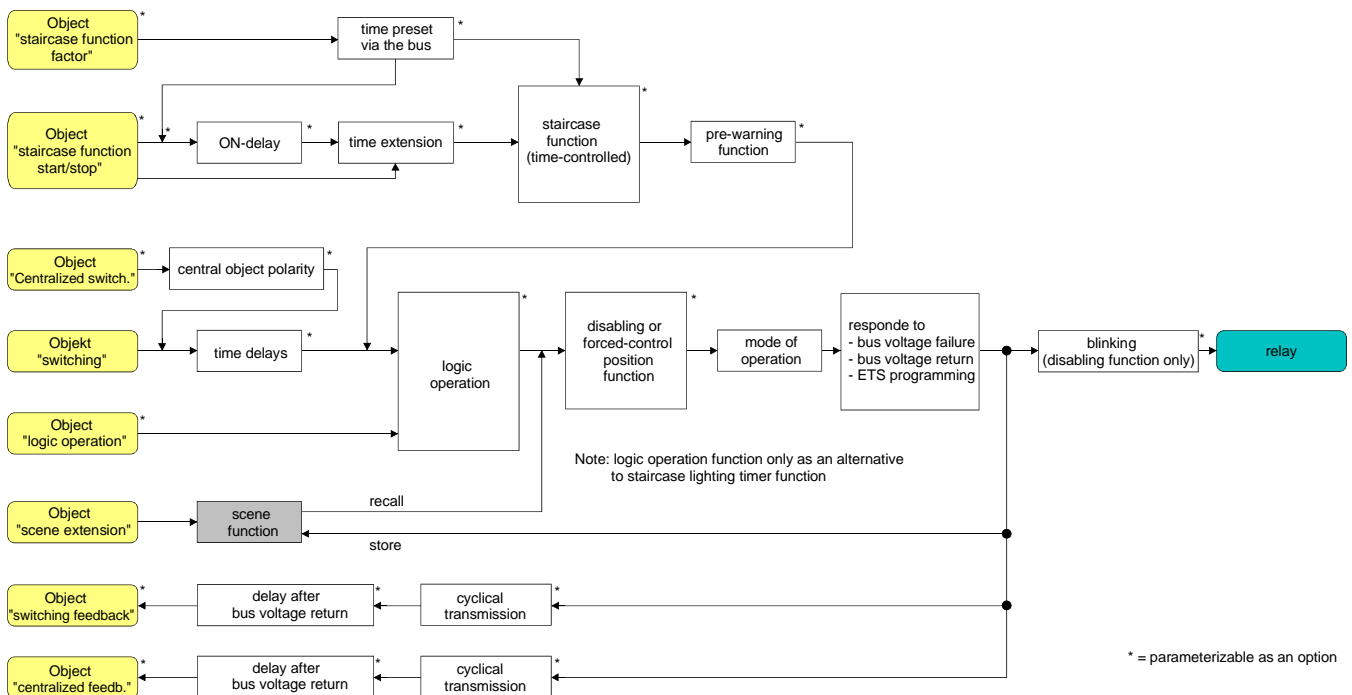

Fig. 15: Functional diagram of the scene function

Presetting a scene recall delay for the scene function

Each scene recall of an output can optionally also be delayed. With this feature, dynamical scene sequences can be configured if several outputs are combined with cyclical scene telegrams.

The scene function must have been enabled on parameter page "Ax – Enabled functions (x = number of output).

- Set the parameter "Delay scene recall?" on parameter page "Ax – Scenes" to "Yes"
The delay time is now activated and can be parameterized separately. The delay only influences the scene recall of the output. The delay time is started on arrival of a recall telegram. The corresponding scene will be recalled and the output set to the respective switching state only after this time has elapsed.
- ❗ Each scene recall telegram restarts the delay time and retriggers it. If a new scene recall telegram is received while a delay is active (scene recall not yet executed), the old (and not yet recalled scene) will be rejected and only the scene last received executed.
- ❗ The scene recall delay has no influence on the storage of scene values. A scene storage telegram within a scene recall delay terminates the delay and thus the scene recall.

Presetting the ETS download behaviour for the scene function

During storage of a scene, the scene values are stored permanently in the device (cf. "Presetting the storage behaviour for the scene function"). To prevent the stored values from being replaced during ETS programming of the application or of the parameters by the originally programmed scene switching states, the actuator can inhibit overwriting of the scene values. As an alternative, the original values can be reloaded into the device during each programming run of the ETS.

The scene function must have been enabled on parameter page "Ax – Enabled functions (x = number of output).

- Set the parameter "Overwrite values stored in the device during download ?" on parameter page "Ax – Scenes" to "Yes".
During each ETS programming of the application or of the parameters, the scene values parameterized in the ETS for the output concerned will be programmed into the actuator. Scene values stored in the device by means of a storage function will be overwritten, if any.
- Set the parameter "Overwrite values stored in the device during download ?" on parameter page "Ax – Scenes" to "Yes".
Scene values stored in the device with a storage function will be maintained. If no scene values have been stored, the switching commands last programmed in the ETS remain valid.
- ❗ When the actuator is put into operation for the first time, this parameter should be set to "Yes" so that the output is initialized with valid scene values. Otherwise, the values in the actuator are "0" (off) for all scenes.

Presetting scene numbers and scene switching state for the scene function

The datapoint type of the scene extension object permits addressing of up to 64 scenes max. For this reason, the scene number (1...64) with which the scene is addressed, i.e. recalled or stored, must be determined for each internal scene (1...8) of the output. Moreover, the switching state to be set for the output in case of a scene recall must be specified as well.

The scene function must have been enabled on parameter page "Ax – Enabled functions (x = number of output).

- Set the parameter "Scene x activatable by scene number" (x = number of the scene (1...8)) for each scene on parameter page "Ax – Scenes" to the numbers with which the scenes are to be addressed. A scene can be addressed with the parameterized scene number. A setting of "0" deactivates the corresponding scene so that neither recalling nor storage is possible.
- ❏ If the same scene number is parameterized for several scenes, only the scene with the lowest internal scene number (1...8) will be addressed. The other internal scenes will be ignored in this case.
- Set the parameter "Switching state for scene x" (x = number of the scene (1...8)) on parameter page "Ax – Scenes" for each scene to the desired switching command ("on" or "off").
In case of a scene recall, the parameterized switching command is recalled and the output is set correspondingly.
- ❏ The output is set to the switching command in a scene recall only if no forced-position or disabling function is active.
- ❏ The parameterized switching command is adopted in the actuator during programming with the ETS only if the parameter "Overwrite values stored in the device during an ETS download ?" is set to "Yes".

Presetting the storage behaviour for the scene function

The logical state established at the output in accordance with the functional diagram ("on" or "off") can be stored internally via the extension object during reception of a scene storage telegram. In this case, the switching state can be influenced before the storage by all functions of the output provided the individual functions have been enabled (e.g. also the disabling function, forced-control position function, etc.).

Rule of thumb: The logical state stored is the one that is reported to the bus by the non-inverted feedback telegram or the one that would have been reported back to the bus had the feedback function not been disabled.

The scene function must have been enabled on parameter page "Ax – Enabled functions (x = number of output).

- Set the parameter "Storage function for scene x" (x = number of the scene (1...8)) on parameter page "Ax – Scenes" for each scene to "Yes".
The storage function is activated for the scene in question. On reception of a storage telegram via the "Scene extension" object, the current logical state will be internally stored.
- Set the parameter "Storage function for scene x" (x = number of the scene (1...8)) on parameter page "Ax – Scenes" for each scene to "No".
The storage function is deactivated for the scene in question. A storage telegram received via the "scene extension" object will be rejected.

Operating hours counter

The operating hours counter tracks the ON-time of a switching output. For the operating hours counter an output is actively on, when the relay contact is closed, i.e. when current is flowing to the load. This means that the counter always evaluates closed contacts independent of the selected mode of operation (make or break contact) and of the logical feedback of the switching status.

The operating hours counter sums up the determined ON-time for a closed relay contact precise to the minute rounding the times off to the full hours (cf. Fig. 16). The accumulated operating hours are tracked in a 2-byte counter and stored permanently in the device. The current count can be transmitted cyclically or after the change of a counting interval to the bus via the communication object "Operating hours counter value".

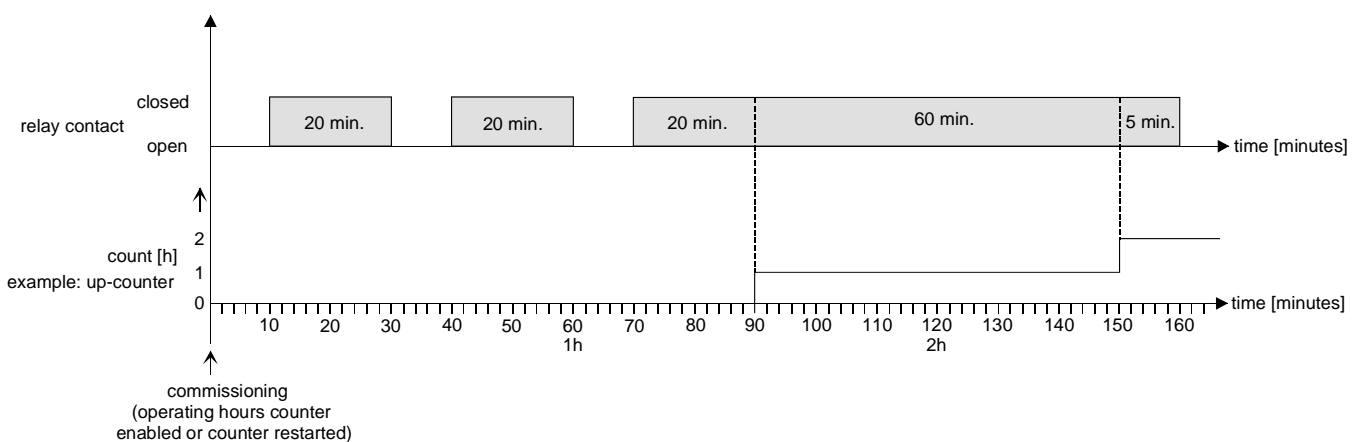

Fig. 16: Functional principle of the operating hours counter

In the state as delivered, all operating hours values of the actuator are zero and no operating hours will be counted if the counter has not been enabled in the parameters of the output concerned. If enabled, the operating hours counter begins counting and summing up the operating hours immediately after commissioning of the actuator.

If an operating hours counter is later on again disabled in the parameters and if it is then programmed with the counter disabled, all operating hours counted beforehand for the output concerned will be deleted. After re-enabling, the operating hours counter always begins with "0".

The operating hours stored in the device (full hours) are not lost after a bus voltage failure or after programming with the ETS. Accumulated operating minutes (full hour not yet reached) are, however, discarded in this case.

After bus voltage return or an ETS download, the actuator passively updates the communication object "Value operating hours counter" for each output. The object value can be read out, if the Read flag is set. The object value, if any, is actively transmitted to the bus depending on the automatic transmission parameters, as soon as the parameterized transmit delay after bus voltage return has elapsed (cf. "Presetting the transmission behaviour of the operating hours counter").

Any manual switching of the relays by means of the slide switches is not detected by the operating hours counter. This means that manual closing of a contact does not activate the operating hours counter and that manual opening does not interrupt a counting cycle in progress.

Activating the operating hours counter

- Set the parameter "Operating hours counter" on parameter page "Ax – Enabled functions" to "Enabled".

The operating hours counter is activated.

Deactivating the operating hours counter

- Set the parameter "Operating hours counter" on parameter page "Ax – Enabled functions" to "Disabled".

The operating hours counter is deactivated.

- ⓘ Disabling of the operating hours counter and subsequent programming with the ETS causes the counter to be reset to "0".

Presetting the counting mode of the operating hours counter

The operating hours counter can be configured as an up-counter or a down-counter. Depending on the above mode, the counter permits presetting a limit or starting value which can be used, for instance, to monitor the hours in operation of a lamp by restricting the counting range.

Up-counter:

After activation of the operating hours counter by enabling it in the ETS or by a restart, the operating hours will be counted started from "0". The maximum counting capacity is 65535 hours. Thereafter, the counter stops and reports reaching the maximum count via the "Runout operating hours counter" object.

As an option, a limit value can be preset either in the ETS or via the communication object "Limit value operating hours counter". In this case, the counting status is reported to the bus via the "Runout operating hours counter" object already when the limit value is reached. If not restarted, the counter will nevertheless continue counting until the max. capacity of 65535 hours is reached and stop thereafter. A new count begins only after the counter is new started.

Down-counter

After enabling the operating hours counter in the ETS, the count is "0" and the actuator reports for the output concerned after programming or after a bus voltage return via the "Runout operating hours counter" object that the counter is running. Only after a restart will the down-counter be preset to the max. value of 65535 and the counting operation be started.

As an option, a start value can be preset either in the ETS or via the communication object "Start value operating hours counter". If a start value has been preset, the down-counter will be initialized after a restart with this value instead of the max. value. The counter will then decrement the hours beginning with the start value. When the down-counter has reached "0", the counting status is reported to the bus via the "Runout operating hours counter" object and counting is stopped. A new count begins only after the counter is new started.

The operating hours counter must have been enabled on parameter page "Ax – Enabled functions (x = number of output).

- Set the parameter "Type of counter" on parameter page "Ax - Operating hours counter" (x = number of output) to "up-counter". If limit value monitoring is desired, set the parameter "Limit value preset ?" to "yes, as specified in parameter" or to "yes, as received via object". Otherwise, set the parameter to "no". In the "yes, as specified in parameter" setting, specify the required limit value (0...65535 h).

The counter increments the operating hours beginning with "0". If the limit value monitoring function is active, the actuator sends a "1" telegram for the output concerned via the "Runout operating hours counter" object as soon as the preset limit value is reached. Otherwise, the counter status will be transmitted only after reaching the max. value of 65535.

- Set the parameter "Type of counter" on parameter page "Ax - Operating hours counter" (x = number of output) to "down-counter". If a start value preset is required, set the parameter "Start value preset ?" to "yes, as specified in parameter" or to "yes, as received via object". Otherwise, set the parameter to "no". In the "yes, as specified in parameter" setting, specify the required start value (0...65535 h).

After a restart, the counter decrements the operating hours until "0" is reached. If the start value preset mode is active, the counter counts down from the start value. Otherwise, counting begins from the max. value 65535. The actuator sends a "1" telegram for the output concerned via the object "Runout operating hours counter" as soon as "0" is reached.

- ❶ The value of the communication object "Runout operating hours counter" is stored internally in a non-volatile memory. After bus voltage return or after ETS-programming, the object will be re-initialized with the previously stored value. If an operating hours counter is in this case identified as elapsed, i.e. if the object value is a "1", an additional telegram will be actively transmitted to the bus as soon as the parameterized transmit delay has elapsed after bus voltage return. If the counter has not yet run out (object value "0"), then no telegram will be sent after bus voltage return or programming with the ETS.
- ❶ In case of start value preset via communication object: The values received via the object will be adopted as valid only after a restart of the operating hours counter and stored internally in a non-volatile memory. After bus voltage return or after ETS-programming, the object will be initialized with the last stored value. The values received are lost during a bus voltage failure or an ETS download, if the counter has not been restarted beforehand. For this reason, it is recommended to always restart the counter whenever a new start or limit value is being preset.
As long as no limit or start value has been received via the object, a fixed standard value of 65535 is the default. The values received via the object and stored will be reset to the default value, if the operating hours counter is disabled in the parameters of the ETS and if an ETS download is made.
- ❶ In case of limit or start value preset: If the start or limit value is being preset as "0", the following cases must be distinguished...
Preset as parameterized: The counter runs out immediately after enabling with ETS download or after a counter restart.
Preset via object: A counter restart will be ignored to avoid an undesired reset (e.g. site operation → hours already counted by manual operation).
- ❶ If the counting direction of an operating hours counter is reversed by parameter change in the ETS, the counter should always be restarted after programming of the actuator to ensure its re-initialization.

Restarting the operating hours counter

The operating hours count can be reset at any time by the "New start operating hours counter" communication object. The polarity of the restart telegram object is fixed. "1" = restart / "0" = no reaction.

In case of an up counter, the counter will be initialized during restart with a "0" and in case of a down counter with the start value. If no start value has been parameterized or preset via the object, the start value is fixed with 65535.

During each restart of the counter, the initialized count will be transmitted actively to the bus.

During a restart, the "Runout operating hours counter" message will be reset as well. In this case, a "0" telegram will be transmitted to the bus via the "Runout operating hours counter" object.

In addition, the limit or start value will be initialized as well.

- ❗ If a new limit or start value has been preset via the communication object, the counter should always be restarted thereafter. Otherwise, the received values will be lost during a bus voltage failure or an ETS download.
- ❗ If a start or a limit value is preset with "0", the device will show different reactions during a restart depending on the type of value preset...
 - Preset like parameter:
The counter runs out immediately after a counter restart.
 - Preset via object:
A counter restart will be ignored to avoid an undesired reset (e.g. after installation of the devices with hours already being counted by manual operation). To perform the restart, it is necessary to preset at first a start or limit value greater than "0".

Presetting the transmit behaviour of the operating hours counter

The current value of the operating hours counter is always tracked in the communication object "Value operating hours counter". After bus voltage return or an ETS download the actuator passively updates the communication object "Value operating hours counter" for each output. The object value can be read out, if the "Read" flag is set.

In addition, the transmit behaviour of this communication object can be preset.

The operating hours counter must have been enabled on parameter page "Ax – Enabled functions (x = number of output).

- Set the parameter "Automatic transmission of counting value" on parameter page "Ax – Operating hours counter" (x = number of output) to "after change by interval value". Set the "Counting value interval (1...65535 h)" to the desired value.
 - The count is transmitted to the bus as soon as it changes by the preset count value interval. After bus voltage return or after ETS programming, the object value will be automatically transmitted after the "Delay after bus voltage return" has elapsed, when the current count corresponds to the count value interval or a multiple thereof. A count of "0" will in this case always be transmitted.
- Set the parameter "Automatic transmission of counting value" on parameter page "Ax – Operating hours counter" (x = number of output) to "cyclical".
 - The count value is transmitted cyclically. The cycle time is defined channel-independent on the parameter page "Time settings". After bus voltage return or after programming with the ETS, the count will be transmitted to the bus for the first time after the parameterized cycle time has elapsed.

Current measurement

The actuator permits measuring the load current separately for each output. Load currents are measured only in those cases where the relay contact of an output is closed, i.e. when current is flowing into the load. This means that the load current is always measured when relay contacts are closed independent of the selected mode of operation (make or break contact) and of the logical feedback of the switching status.

If the current measurement function is enabled, the measured load current value can be transmitted to the bus via the separate 2-byte communication object "current intensity value" and thus be displayed on a central visualization device. The current intensity value is transmitted in "mA" as defined by the datapoint type (KNX 9.021).

The valid current intensity value range is defined by the limits of the current intensity measurement. The measurement can detect load currents between ca. 250 mA and 16 A with the respective measuring tolerance and track these values in the object. The measuring tolerance is ± 100 mA with currents of less than 1 A and ± 8 % of the measured value with currents greater than 1 A.

An open relay contact, an output not supplying current or a measuring value below the lower limit value minus the measuring tolerance is reported back as a current of "0 mA".

The transmitting behaviour of the "current intensity value" object is defined by a presettable transmit interval (100 mA to 16 A). Cyclical transmission can be parameterized as an option.

The currents supplied by outputs whose relay contacts are closed are measured cyclically in succession. The measurement of an output lasts at least 700 ms and can be slightly longer, if the bus load is higher. The measuring interval (T_{INT} : time between individual current measurements of an output – cf. Fig. 16) depends on the number of closed relay contacts of the actuator. If all outputs of the actuator are closed, the load current measurement of an output will be repeated 2.8 s (4-gang type) or 5.6 s (8-gang type) at the earliest after the last measurement. Current fluctuations of an output occurring within this measuring interval cannot be detected.

The load current measurement is not synchronous with the switching events. For this reason it may be the case that switch-on currents exceeding the nominal load current can be briefly detected and transmitted to the bus via the "current intensity value" object (cf. Fig. 16). If the load monitoring function is used (cf. "Presetting the current measurement load monitoring function"), a time delay after a switching event for debouncing purposes can be parameterized as an option. During this delay, the current intensity is set to "0 mA"

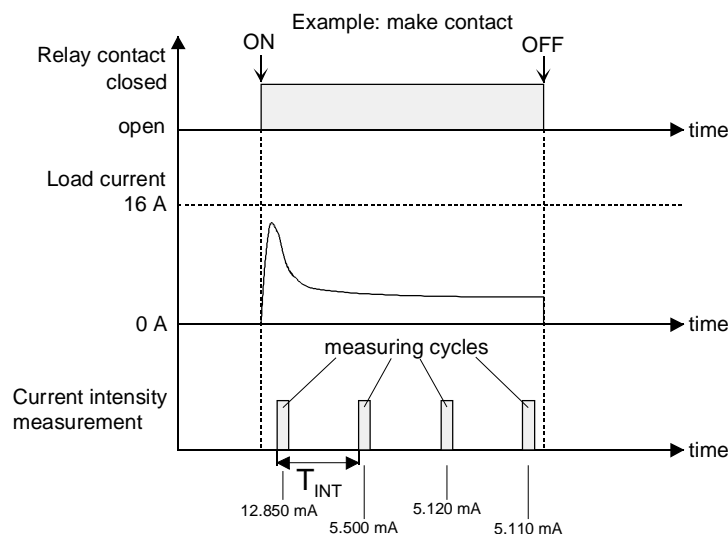

Fig. 16: Example of current measurement at the time an output is switched on

- ❗ Only those currents with a sinusoidal voltage characteristic and a frequency of 50 or 60 Hz can be measured correctly. Other signal types as, for instance, phase cut-on or phase cut-off signals result in a distortion of the measured values. In this case, the measured value is not meaningful.
- ❗ In case of load currents that are close to the lower load limit value (250 mA), it may be the case that due to the measuring tolerance current intensity values beyond the limit value (< 250 mA) are calculated and transmitted via the "current intensity value" object to the bus. These measuring values are then subject to great deviations and are not meaningful.
- ❗ The current measurement is limited at the upper end to 16 A. It must be ensured that the nominal current of the connected load does not exceed this limit (cf. "Technical Data") to prevent damage to the actuator.
The inrush currents flowing for a short time especially when capacitive loads such as electronic transformers or ballasts are switched on, may significantly exceed the nominal current. The relays of C-load actuators are especially designed for capacitive loads and therefore suited for relatively high inrush currents. The current measurement circuit, too, can measure load currents above 16 A for a short time and transmit the result via the "current intensity value" object to the bus. These measuring values are then subject to great deviations and are not meaningful.
- ❗ Closing a relay contact by hand with the slide switches does not result in a current measurement when the relay contact of the output was last opened via a bus operation. Manual closing or opening nevertheless has an influence on the current measurement, if the relay was last closed via a bus operation.

Activating the current measurement function

- Set the parameter "Current measurement" on parameter page "Ax – Enabled functions" to "enabled".
The current measurement function is active.

Deactivating the current measurement function

- Set the parameter "Current measurement" on parameter page "Ax – Enabled functions" to "disabled".
The current measurement function is inactive.

Presetting the transmitting behaviour of the current measurement function

The measured load current is always tracked in the "current intensity value" object and can be read out at any time. In addition, the transmitting behaviour of this communication object can be preset. The object can transmit the current intensity in case of value changes and – in addition or as an alternative – also cyclically.

The current measurement function must be enabled on parameter page "Ax – Enabled functions (x = number of output).

- Set the parameter "Transmit current intensity in case of value change ?" on parameter page "Ax - Current measurement" (x = number of output) to "yes". Set the parameter "Transmit on value change by (100 ... 16000 mA)" to the desired current interval.

The current intensity value is transmitted to the bus as soon as it changes by the preset change interval. After bus voltage return or after ETS programming, the current intensity value last measured during the delay time will be automatically transmitted after the "Delay after bus voltage return" has elapsed, when the relay contact is closed and when the existing current intensity value corresponds to the value change interval or a multiple thereof. A current intensity value of "0 mA" (output contact closed but not supplying current) will always be transmitted in this case.

No value will be transmitted to the bus, if the relay was last opened by a bus operation or by the parameterization of the behaviour after bus voltage return or after programming with the ETS.

- Set the parameter "Cyclical transmission of current intensity value" on parameter page "Ax - Current measurement" (x = number of output) to "yes".

The respective current intensity value is transmitted cyclically. The cycle time is defined channel-independent on the parameter page "Time settings". After bus voltage return or after programming with the ETS, the current intensity value will be transmitted – also for open relay contacts (0 mA) – to the bus automatically after the end of the parametrized cycle time and then regularly.

Presetting the current measurement load monitoring function

The current measurement function can additionally be supplemented by a load monitoring function. For this purpose, two limit values can optionally be specified, one for the upper and one for the lower current limit. If the current exceeds or falls below the fixed limits, for instance after a load failure or after a change of the load, the actuator can transmit 1-bit message telegrams to the bus.

The message telegrams can be parameterized independently for each load limit and are transmitted to the bus via separate communication objects. The load range limits are monitored only if the relay contact of the output is closed, i.e. when current is flowing into the load. A telegram reporting an overload or an underload condition transmitted beforehand is reversed when the relay contact is opened via a bus operation (inverted message value).

To increase noise immunity during reporting (suppression of small current fluctuations), a hysteresis can be separately specified for each current limit. The hystereses are parameterized in the ETS as a percentage of the current limits (cf. Figs. 17 & 18). For current measurements it is moreover possible to parameterize a delay (T_{DELAY}) after a switching event (change from break to make) so that load monitoring is delayed and a debouncing effect for switch-on currents achieved. No current measurement is performed during this delay so that the current intensity value for this time is set to "0".

The load monitoring current limits can be preset in two ways:

- Monitoring can be based on fixed load limits parameterized in the ETS. The load limits can be freely defined independent of the load current (cf. Fig. 17).

This method is suitable, for instance, for fixed and permanent loads.

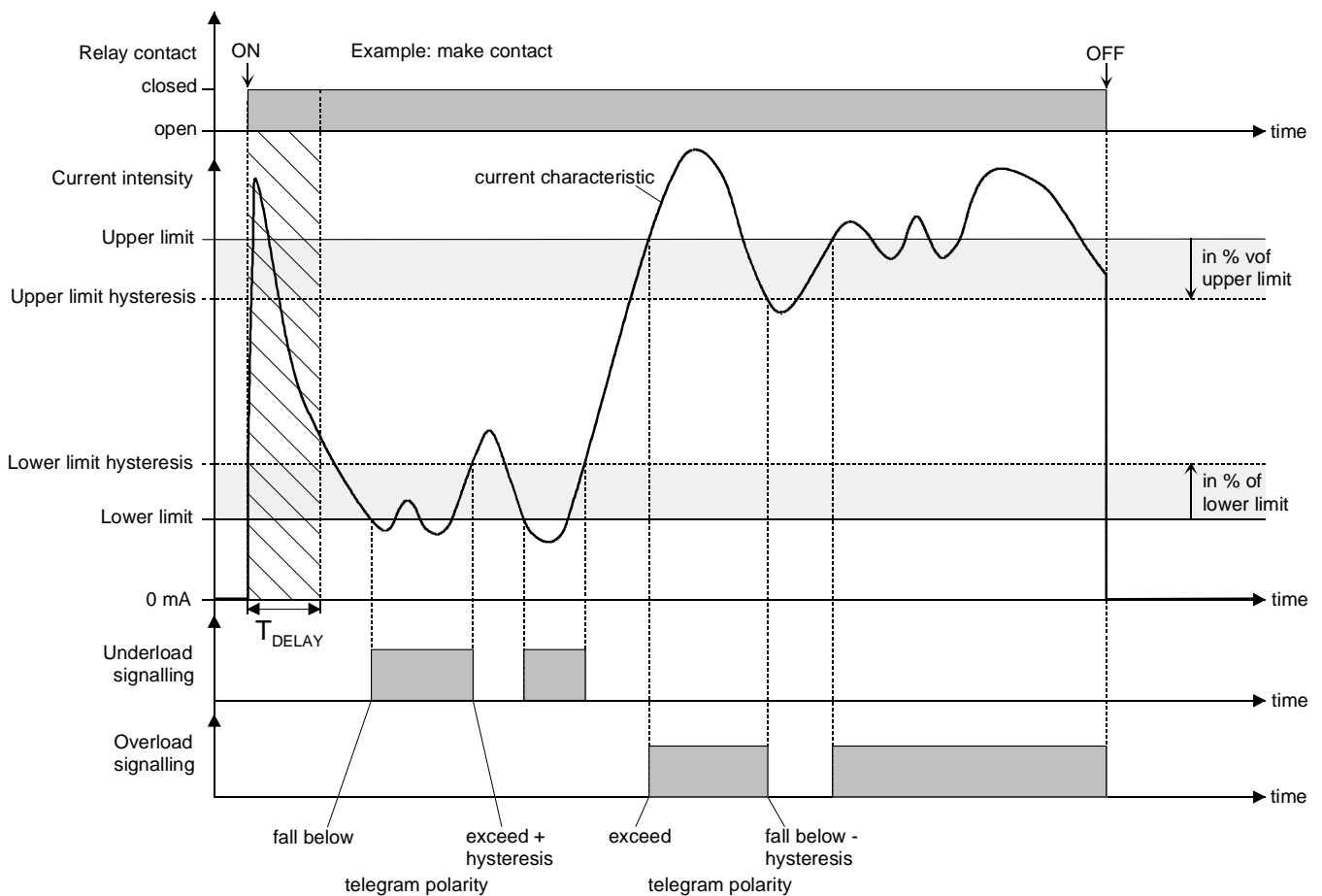

Fig. 17: Load monitoring with fixed load limits (exemplary current characteristic)

- Monitoring is based on current limit values learnt in operation (teach-in). This setting is suitable, for instance, for changing loads.
The teach-in procedure is initiated for each output by a separate communication object. The load current flowing at the time of teach-in is then measured and saved permanently in the actuator. The load limits are then derived from the load current value learnt and a fixed ETS parameter preset (cf. Fig. 18).

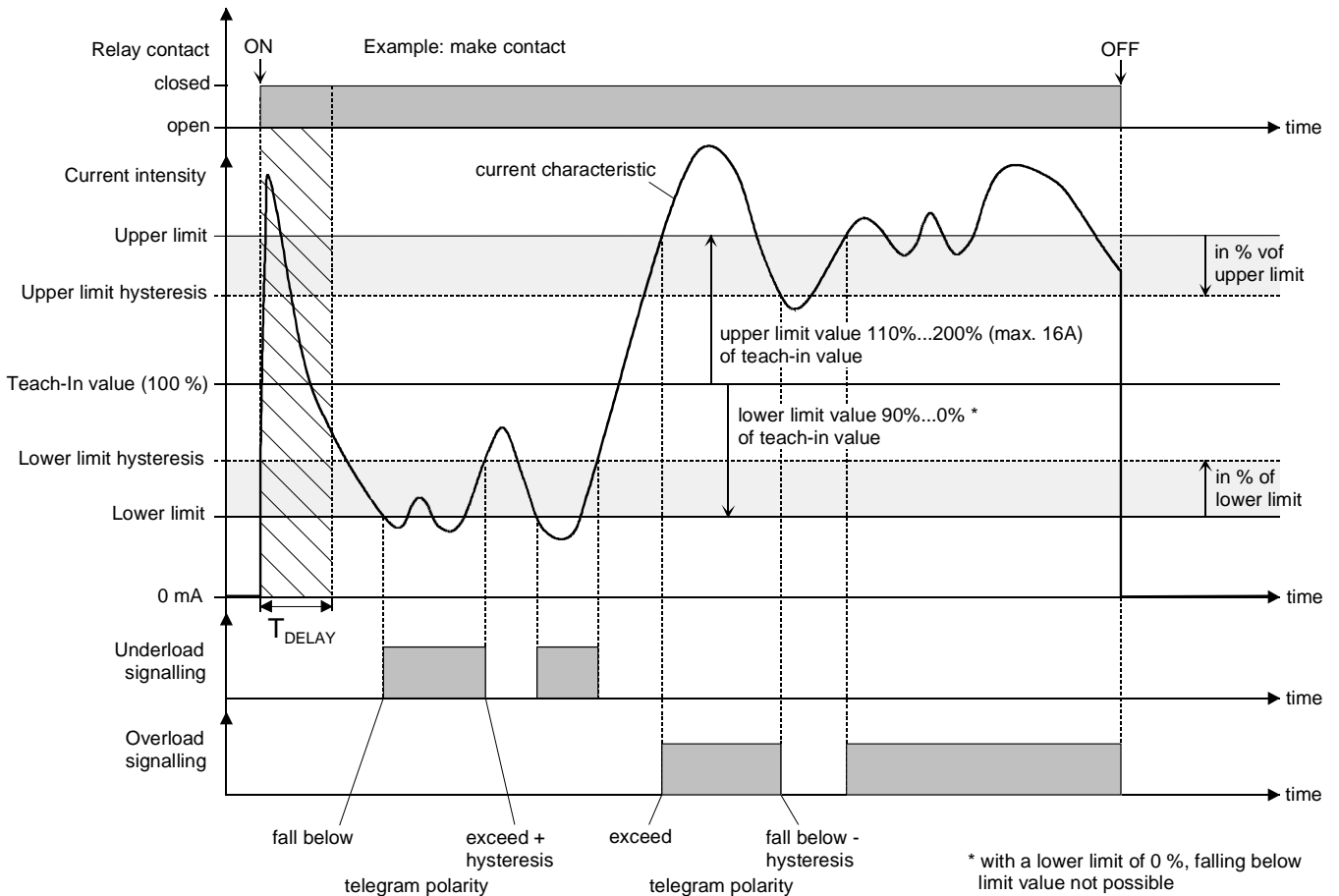

Fig. 18: Load monitoring with teach-in (exemplary current characteristic)

The current measurement function must be enabled on parameter page "Ax – Enabled functions (x = number of output).



ATTENTION:

The current measurement is not performed permanently, but cyclically with sometimes greater intervals. The load monitoring function of the current measurement circuitry is not capable of detecting current fluctuations or failures. Risk of irreparable damage to the actuator or the connected load, if the load monitoring function is used for fault shutoff purposes.

The current sensing and load monitoring functions must not be used for safety-related applications (e.g. overload or residual current detection).

- Set the parameter "Load monitoring" on parameter page "Ax - Current measurement" (x = number of output) to "with fixed load limits". Set the parameter alternatively to "with teach-in".

The load monitoring function is enabled and the type of limit value preset is defined. Depending on the selected setting, further parameters are displayed:
- Set the parameter "Report overload condition ?" on parameter page "Ax - Current measurement" (x = number of output) to "yes", if monitoring of the upper limit is desired. Specify a value for the "Current intensity value at upper limit" and the "Hysteresis at upper limit" based thereon. Parameterize the "Telegram in case of overload" entry.

The overload monitoring feature is activated. If the set current intensity value is exceeded, a telegram depending on the parameterized polarity ("exceed = 1/0") is transmitted to the bus. Only if the current falls below the upper hysteresis level will the telegram with the inverse message value ("fall below - hysteresis = 0/1") be transmitted
- Set the parameter "Report underload condition ?" on parameter page "Ax - Current measurement" (x = number of output) to "yes", if monitoring of the lower limit is desired. Specify a value for the "Current intensity value at lower limit" and the "Hysteresis at lower limit" based thereon. Parameterize the "Telegram in case of underload".

The underload monitoring feature is activated. If the current falls below the set current intensity value, a telegram depending on the parameterized polarity ("fall below = 1/0") is transmitted to the bus. Only if the current exceeds the lower hysteresis level will the telegram with the inverse message value ("exceed + hysteresis = 0/1") be transmitted.
- Set the parameter "Time delay for current measurement after switching event (0...59 s)" (T_{DELAY}) to the required value, if debouncing after a switching event is desired.

With a setting between 1 s...59 s, the measurement of the current intensity after a switching event will be activated with a delay. A setting of "0 s" deactivates the time delay and causes the current to be measured immediately after switching already during the next measuring cycle.
- ⓘ The "Time delay for current measurement after switching event" will only be evaluated for a switching event with contact change from break to make. The time is also activated when the relay contact is actively controlled and closed (e.g. "make contact" or track closed state) after bus voltage return or after ETS programming.

No current measurement is performed during the time delay so that the current intensity value for this time is set to "0".

i Notes on load monitoring with teach-in:

The load monitoring function is activated only by teaching a current intensity value. Learning by the teach-in procedure takes place only ...

- if a "1" telegram has been written into the teach-in object, and
- if the relay of the respective output is closed, and
- if at least the current with the smallest resolution (ca. 250 mA) can be measured, and
- if at least one of the load range limits is to be monitored, and
- if no time delay for the current measurement after a switching event is active.

Otherwise, the teach-in telegram will be discarded.

A current intensity value learnt during the teach-in procedure will be stored permanently in the actuator so that the teach-in current intensity value will continue to be available and evaluated even after bus voltage return or after ETS programming.

If the teach-in function is deactivated in the parameters and if the device is reprogrammed by the ETS, the actuator deletes a previously learnt current intensity value for the output concerned. This means that the current intensity value has to be learnt again when the teach-in function is reactivated.

Every successful teach-in attempt generally results in overwriting previously learnt current intensity values. A successful teach-in attempt will also cause previously reported and active overload or underload conditions to be reversed (inverted message value is transmitted to the bus).

When the teach-in function is used in conjunction with the monitoring of the upper load range limit, the limit is dynamically adapted to max. 16 A, if the combination of the learnt current intensity value and the parameterized upper limit results in a value greater than 16 A.

- i** When specifying the hysteresis parameters make sure that the hysteresis currents derived from the limit values do not overlap. Otherwise risk of malfunction → upper hysteresis limit > lower hysteresis limit.
- i** The message telegrams are transmitted to the bus as soon as the currents are above or below the limit values or the hystereses (cf. Figs. 17 + 18). The actuator transmits message telegrams with the parameterized polarity after the end of the "Delay after bus voltage return" only if the currents – after return of bus voltage or after ETS programming – are below or above the limits. In all other cases, no message telegrams will be sent after a reset.

Supplementary functions

For each output, supplementary functions can be enabled. As supplementary function, a disabling function or alternatively a forced-control position function can be configured. Only one of these functions can be enabled for an output. Additionally, a logical operation function can be parameterized. These additional functions are enabled on parameter page "Ax – Supplementary functions" (x = number of output).

Presetting the disabling function as supplementary function

As can be seen from the functional diagram (cf. Fig. 19), the disabling function can also be combined with other output functions. In case of an active disable, the upstream functions are overridden so that the output concerned will be locked in the disabled state. The override feature can also be used to implement a permanent lighting function.

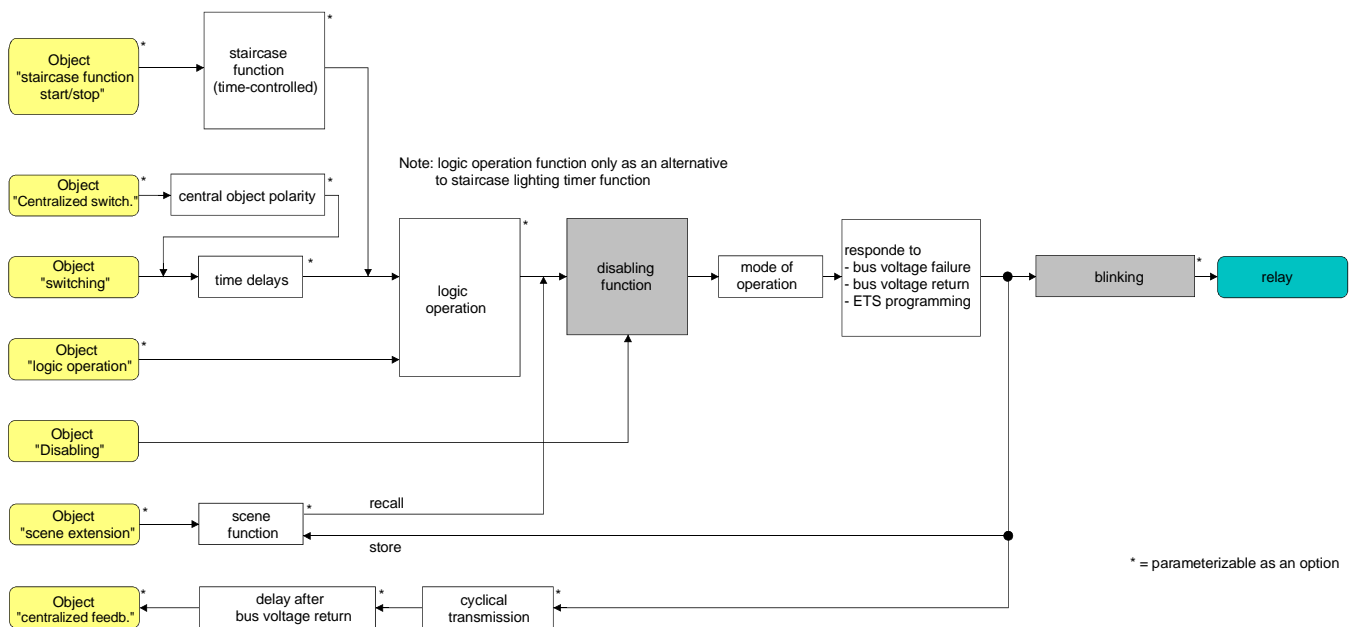

Fig. 19: Functional diagram of the disabling function

- Set the parameter "Selection of supplementary function" on parameter page "Ax – Supplementary functions" to "Disabling function".
The disabling function is enabled. The "Disabling" communication object and the parameters of the disabling function are visible.
- Set the parameter "Polarity of disable object" on parameter page "Ax – Supplementary functions" to the desired polarity.
- ⓘ After bus voltage return or programming of the application or of the parameters with the ETS, the disabling function is always deactivated (object value "0"). In the inverted setting ("1 = enabled; 0 = disabled"), a "0" telegram update must first be sent after the initialization before the disabled state is activated.
- ⓘ Updates of the disabling object from "ON" to "ON" or from "OFF" to "OFF" show no reaction. The relay remains in the position last set, if applicable also set manually.
- ⓘ An output disabled via the bus can still be operated by hand!

- Set the parameter "Behaviour at the beginning of the disabling function" on parameter page "Ax – Supplementary functions" to the desired behaviour.

At the beginning of disabling, the parameterized behaviour will be executed and the output locked. When the setting "No change of switching state" is selected, the relay of the output shows no reaction and remains in the switching state last set (switching state in acc. with last non-inverted feedback telegram). When the setting "Blinking" is selected, the output is switched on and off cyclically during disabling. The blinking time is generally parameterized for all outputs on the "General" parameter page. During blinking, the logic switching state is "ON - 1".
 - Set the parameter "Behaviour at the end of the disabling function" on parameter page "Ax – Supplementary functions" to the desired behaviour.

At the end of disabling, the parameterized behaviour will be executed and the output re-enabled. When the setting "No change of switching state" is selected, the relay of the output shows no reaction and remains in the state last set by the disabling function. When the setting "Setting tracked state" is selected, the last switching state existing before the disabling function or the switching state internally tracked during the disabling function will be set. In this case, residual times of time functions or of the staircase functions will be tracked as well, if they have not completely elapsed at the time of re-enabling the disabling function. In the settings "No change of switching state", "Switching on", "Switching off" or "Blinking", the states set at the end of the disabling function have no influence on time or staircase functions. When the setting "Blinking" is selected, the output is switched on and off cyclically after disabling. Blinking persists until a new switching state is set. The blinking time is generally parameterized for all outputs on the "General" parameter page. During blinking, the logic switching state is "ON - 1".
- i The states defined for the end of the disabling function override a logic function if parameterized. The parameterized logic operation will be executed and the result forced on the output only if at least one input state of the logic operation changes or is updated after the disabling state has been suspended.
- i Blinking: The actuator takes its power supply completely from the bus and switches the output relays only after a sufficient amount of energy has been stored. In case of blinking with short intervals this means that switching states cannot always be tracked because of the simultaneous state changes in several outputs. For this reason, it is important to program sufficiently long blinking rates if several outputs are to blink at the same time.

Presetting the forced-control position function as supplementary function

As can be seen from the functional diagram (cf. Fig. 20), the forced-control position function can also be combined with other output functions. In case of an active forced-control position function, the upstream functions are overridden so that the output concerned will be locked in the forced position.

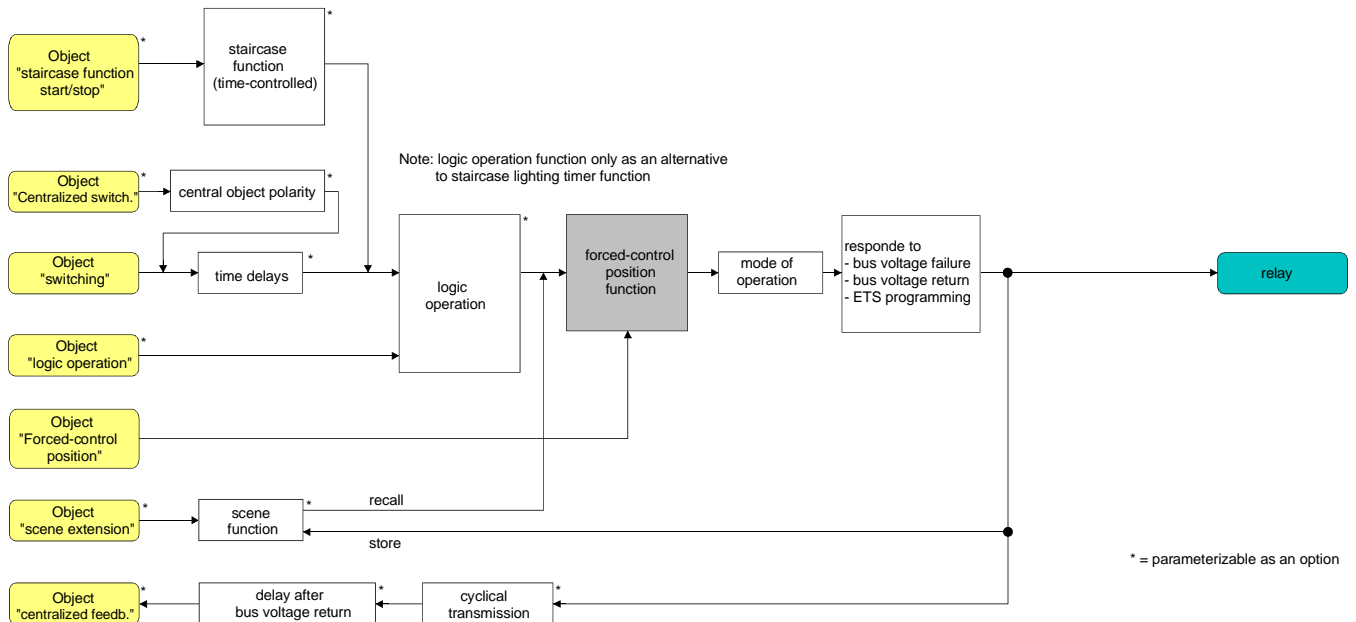

Fig. 20: Functional diagram of the forced-control position function

- Set the parameter "Selection of supplementary function" on parameter page "Ax – Supplementary functions" to "Forced-control position".
The forced-control position function is enabled. The "Forced-control position" communication object and the parameters of the forced-control position function are visible.

In case of the 2-bit forced-control position, the switching state of the output is directly determined by the forced-control position telegram. The first bit (bit 0) of the "Forced-control position" object specifies the switching state to be forced on the output. The second bit (bit 1) activates or deactivates the forced control (cf. table 1).

Bit 1	Bit 0	Function
0	x	forced-control position not active ⇒ normal control
0	x	forced-control position not active ⇒ normal control
1	0	forced-control position active: switching off
1	1	forced-control position active: switching on

Table 1: Bit coding of forced-control position

- ⓘ Updates of the forced-control position object from "Forced-control position ON" to "Forced-control position ON" will cause the relay every time to switch the contact into the forced-control position. Updates from "Forced-control position OFF" to "Forced-control position OFF" remain without effect.
- ⓘ An output under forced control from the bus can still be operated by hand!

- Set the parameter "Behaviour at the end of the forced-control position function" on parameter page "Ax – Supplementary functions" to the desired behaviour.

At the end of the forced-control position function, the parameterized behaviour will be executed and the output re-enabled for normal control. When the setting "No change of switching state" is selected, the relay of the output shows no reaction and remains in the state last set by the forced-control position function.

When the setting "Tracking the switching state" is selected, the switching state last existing before forced control or the one tracked internally while the forced-control position function was active will be set at the end of the forced-control position function. In this case, residual times of time functions or of the staircase functions will be tracked as well, if they have not completely elapsed at the time of re-enabling the disabling function. In the settings "No change of switching state", "Switching on" or "Switching off", the states set at the end of the forced-control position function have no influence on time or staircase functions.

- ❗ The states defined for the end of the forced-control position function override a logic function if so parameterized. The parameterized logic operation will be executed and the result forced on the output only if at least one input state of the logic operation changes or is updated after the forced-control state has been suspended.

The communication object of the forced-control position function can be initialized after bus voltage return. In this way, the switching state of the output can be influenced when the forced-control position function is activated.

- Set the parameter "Behaviour after bus voltage return" on parameter page "Ax – Supplementary functions" to the desired behaviour.

After bus voltage return, the parameterized state is adopted in the "Forced-control position" communication object. In case of an active forced position, the output will be switched immediately after bus voltage return to the corresponding state and locked by forced control until the forced-position condition is cancelled via the bus. The parameter "Behaviour after bus voltage return" will in this case not be evaluated for the output concerned.

If "State of forced-control as before bus voltage failure" is selected, the forced-control is set to the state which was stored in a non-volatile memory at the time of bus voltage failure. After programming of the application or of the parameters with the ETS, the value is in this case always internally set to "Not active".

- ❗ After bus voltage return or programming of the application or of the parameters with the ETS, the forced-control position function is always deactivated (object value "0").

Presetting the logic function as supplementary function

A logic function can be parameterized separately and independently for each output. This function permits linking the state of the "Switching" object with an additional logic operation object. The state of the communication object for "Switching" can also be evaluated with a delay when an ON-delay or an OFF-delay are defined.

As can be seen from the functional diagram (cf. Fig. 21), the logic function can also be combined with other output functions. A combination with the staircase or the cyclical monitoring function is, however, not possible.

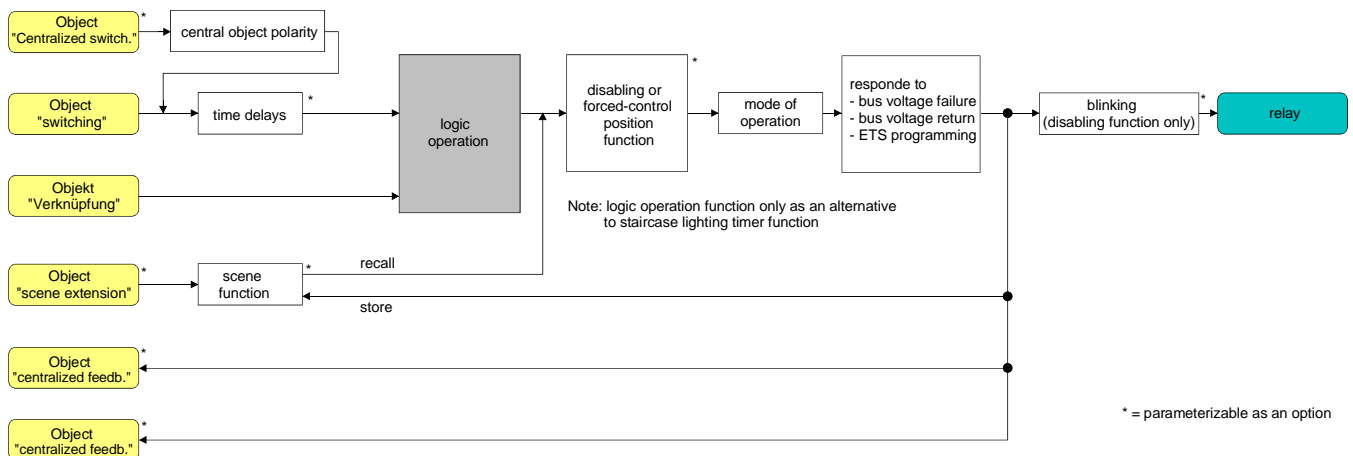

Fig. 21: Functional diagram of the logic function

The following gating operations can be parameterized (cf. Fig. 22)

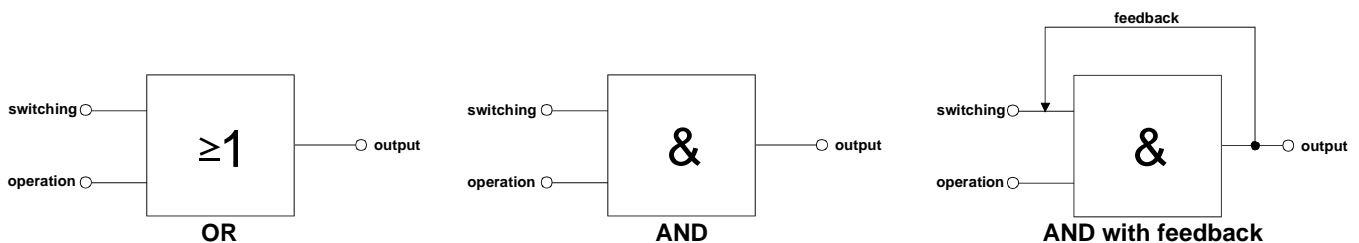

Fig. 22: Gating operations of the logic function

i "AND with feedback:"

With a logic object = "0", the output is always "0" (logic AND). In this case, the feedback signal from the output to the "switching" input will directly reset this input when it is being set. Only if the logic operation object = "1", can the output adopt the logic state "1" after a new "1" has been received on the "Switching" input.

The "Logic operation" object can be initialized after bus voltage return or programming with the ETS with a previously parameterized value so that in case of a telegram update to the "Switching" object a correct operation result is determined immediately and the output set correspondingly.

- Set the parameter "Logic operation function ?" on parameter page "Ax – Supplementary functions" to "Yes".

The logic function is enabled. The "Logic operation" communication object and the parameters of the logic function are visible.

- Set the parameter "Type of logic operation" on parameter page "Ax – Supplementary functions" to the desired type of logic operation.

- Set the parameter "Value of logic operation object after bus voltage return" and "Value of logic operation object after ETS download" on parameter page "Ax – Supplementary functions" to the desired initial conditions.

After bus voltage return or after ETS programming of the application software or of the parameters, the "Logic operation" object is initialized with the preset switching states"

- ❗ After an actuator reset (bus voltage return or ETS programming), the logic function will be executed only if at least one input object of the logic operation is updated by means of a telegram from the bus.
- ❗ The states preset for the end of a disabling or forced-control position function or the switching states that are set after ETS programming, bus voltage failure or after bus voltage return will override the logic function. The parameterized logic operation will be executed and the result forced on the output only if at least one input state of the logic operation changes or is updated.

4.2.4.3 Delivery state

The actuator is delivered with no application program loaded. The relays can be operated manually. There is no feedback to the bus in this case.

The device can be programmed and put into operation with the ETS. The physical address is preset to 15.15.255.

4.2.5 Parameters

Description:	Values:	Remarks:
 General		
Delay after bus voltage return Minutes (0...59)	0...59	To reduce telegram traffic on the bus line after bus voltage activation (bus reset), after connection of the device to the bus line or after programming with the ETS, it is possible to delay all active feedbacks of the actuator. The parameter specifies in this case a delay for all devices. Feedback telegrams for initialization will be transmitted to the bus only after the parameterized delay time has elapsed, if the feedback telegrams are to be transmitted with a time delay. Setting the minutes of the delay time.
Seconds (0...59)	0...17...59	Setting the seconds of the delay time.
Central function ?	yes no	Setting "yes" enables the central function and thus the "Central switching" object. Individual switching outputs can be assigned to the central function only if the function is enabled
Central object polarity	0 = switching off; 1 = switching on 0 = switching on; 1 = switching off	The parameter sets the polarity of the central object.

<p>Make use of centralized feedback ?</p>	<p>no yes, active message object yes, passive status object</p>	<p>To keep the telegram load low during a 'bus initialization', the centralized feedback function of the actuator can be employed. Setting "yes" activates the centralized feedback and enables the corresponding object. The parameter moreover defines whether the feedback telegrams are transmitted actively (telegram transmission in case of changes) or passively (telegram transmission only as a response to a 'Read' request). The communication flags of the object are automatically set by the ETS according to the setting.</p>
<p>Time delay for feedback telegram after bus voltage return ?</p>	<p>yes no</p>	<p>The centralized feedback telegram can be transmitted to the bus with a delay after bus voltage return or after programming with the ETS. Setting "Yes" activates the delay time of the centralized feedback in case of bus voltage return. The delay time is parameterized under "General" (see above). i This parameter is visible as an active message object only if centralized feedback is enabled.</p>
<p>Cyclical transmission of centralized feedback telegram ?</p>	<p>Yes (transm. cyclic and in case of changes) No (transmission only in case of changes)</p>	<p>The object value of the centralized feedback can be transmitted cyclically. The feedback telegram is transmitted to the bus cyclically and after state changes. The cycle time is generally programmed under the "Time settings" entry for all feedback telegrams. The feedback telegram is transmitted to the bus only after state changes. i This parameter is visible as an active message object only if centralized feedback is enabled.</p>

Blinking rate	<p>1 s</p> <p>2 s</p> <p>5 s</p> <p>10 s</p>	<p>At the beginning and at the end of a disabling function (if used), switching outputs can also be parameterized as "blinking". In this case, the outputs change the switching state cyclically. The "Blinking rate" parameter generally defines the ON-time and the OFF-time of a "blinking" output signal for all outputs.</p>
---------------	--	---

Example:
Blinking rate = 1 s
→ 1 s off → 1 s on → 1 s off ...

i The actuator takes its power supply completely from the bus and switches the output relays only after a sufficient amount of energy has been stored. In case of blinking with short blinking rate this means that switching states cannot always be tracked because of the simultaneous state changes in several outputs. For this reason, it is important to program sufficiently long blinking rate if several outputs are to blink at the same time.

 Time settings

<p>Time for cycl. monitoring 0...23 Hours (0...23)</p>	<p>If desired, outputs can be assigned independent of one another to the cyclical monitoring function. If no telegram update on the "Switching" object has been received after the monitoring time has elapsed, the corresponding output relay is set to its default position. The parameter "Time for cycl. monitoring" generally defines the monitoring time for all outputs.</p>
--	---

Setting the monitoring time hours.

Minutes (0...59)	0...2...59	Setting the monitoring time minutes.
------------------	------------	--------------------------------------

Seconds (10...59)	10...59	Setting the monitoring time seconds.
-------------------	---------	--------------------------------------

Default setting: 2 minutes 10 seconds

<p>Time for cyclical transmission of feedback tel. Hours (0...23)</p>	<p>0...23</p>	<p>Depending on parameterization, the different active feedback telegrams of the actuator can transmit their state also cyclically to the bus. The parameter "Time for cyclical transmission of feedback tel." generally defines the cycle time for all outputs.</p> <p>Setting the cycle time hours.</p>
<p>Minutes (0...59)</p>	<p>0...2...59</p>	<p>Setting the cycle time minutes.</p>
<p>Seconds (10...59)</p>	<p>10...59</p>	<p>Setting the cycle time seconds.</p> <p><i>Default setting: 2 minutes 10 seconds</i></p>
<p>Time for cyclical transmission operating hours Hours (0...23)</p>	<p>0...23</p>	<p>Depending on parameterization, the operating hours counters of the outputs can also transmit their count cyclically to the bus. The parameter "Time for cyclical transmission operating hours" generally defines the cycle time for all outputs.</p> <p>Setting the cycle time hours.</p>
<p>Minutes (0...59)</p>	<p>0...59</p>	<p>Setting the cycle time minutes.</p>
<p>Seconds (10...59)</p>	<p>10...59</p>	<p>Setting the cycle time seconds.</p> <p><i>Default setting: 23 hours 0 minutes 10 seconds</i></p>

Time for cyclical transmission of current intensity values Hours (0...23)	0...23	Depending on parameterization, the current measurement function for the outputs can transmit the measured current intensity values also cyclically to the bus. The parameter "Time for cyclical transmission of current intensity values" generally defines the cycle time for all outputs. Setting the cycle time hours.
Minutes (0...59)	0... 10 ...59	Setting the cycle time minutes.
Seconds (10...59)	10 ...59	Setting the cycle time seconds. <i>Default setting: 10 minutes 10 seconds</i>

 Ax – General (x = number of output / All outputs can be parameterized independent of one another.)

Mode of operation		The relays of a switching output can be parameterized as make or break contacts. This feature offers the possibility of inversion the switching states.
	(make contact)	Switching state = off ("0") → relay contact open Switching state = on ("1") → relay contact closed
	break contact	Switching state = off ("0") → relay contact closed Switching state = on ("1") → relay contact open
Behaviour after ETS programming		The actuator permits setting the preferred relay contact position after ETS programming separately for each output.
	close contact	The relay contact is closed after an ETS programming cycle.
	open contact	The relay contact is opened after an ETS programming cycle.
	no reaction	After ETS programming, the relay of the output shows no response and remains in the switching state last selected.
		 The parameterized behaviour will be executed after every application or parameter download by the ETS. A simple download of the physical address alone or partial programming of only the group addresses has the effect that this parameter is disregarded and that the parameterized "Behaviour after bus voltage return" will be executed

Behaviour in case of bus
voltage failure

close contact

The actuator permits setting the preferred relay contact position in case of bus voltage failure separately for each output.

open contact

The relay contact is closed on bus voltage failure.

no reaction

The relay contact is opened on bus voltage failure.

In case of bus voltage failure, the relay of the output shows no reaction and remains in the switching state last selected.

Behaviour after bus voltage return		The actuator permits setting the preferred relay contact position after bus voltage return separately for each output.
	close contact	The relay contact is closed after bus voltage return.
	open contact	The relay contact is opened after bus voltage return.
	state as before bus voltage failure	After bus voltage return, the switching state last selected before bus voltage failure and internally stored on bus voltage failure will be retained.
	no reaction	After bus voltage return, the relay of the output shows no reaction and remains in the switching state last selected.
	activate staircase function (if parameterized)	<p>The staircase lighting function is activated after bus voltage return independent of the "Switching" object. For this setting it is indispensable that the staircase lighting function has been programmed and enabled beforehand. When the staircase function has not been enabled, this setting will produce no reaction after return of the bus voltage.</p> <p>i The device adopts the parameterized behaviour only if the last ETS programming of the application or of the parameters ended at least ca. 20 s ago. Otherwise ($T_{ETS} < 20$ s), the "Behaviour after ETS programming" will be adopted also in case of bus voltage return.</p> <p>i The parameterized behaviour will only be adopted, if no forced control is activated after bus voltage return.</p> <p>i The actuator takes its power supply completely from the bus and switches the output relays only after a sufficient amount of energy has been stored. For this reason, there may be a brief delay after a bus voltage return (5 s max.) before the device adopts the parameterized behaviour.</p>

Assignment to central function ?

This parameter determines the assignment of the output to the central function.

yes (enable central function under "General")

The output is assigned to the central function. The central function is supposed to have been enabled under "General". The assignment has otherwise no effect on the switching output.

no

The output is not assigned to the central function.

Feedback telegram ?

The current switching state of the output can be reported back separately to the bus.

none

No feedback object available for the output. Feedback deactivated.

no inversion, active message object

Feedback and object are activated. The state is transmitted in non-inverted form. The object transmits actively.

no inversion, passive status object

Feedback and object are activated. The state is transmitted in non-inverted form. The object is passive (telegram transmission only as a response to 'Read' request).

inversion, active message object

Feedback and object are activated. The state is transmitted in inverted form. The object transmits actively.

inversion, passive status object

Feedback and object are activated. The state is transmitted in inverted form. The object is passive (telegram transmission only as a response to 'Read' request).

i The communication flags of the object are automatically set by the ETS according to the setting.

<p>Time delay for feedback telegram after bus voltage return ?</p>	<p>yes (delay time under "General")</p> <p>no</p>	<p>The feedback telegram can be transmitted to the bus with a delay after bus voltage return or after programming with the ETS. Setting "Yes" activates the delay time of the feedback in case of bus voltage return. The delay time is parameterized under "General".</p> <p>[i] This parameter is visible as an active message object only if feedback is enabled.</p>
<p>Cyclical transmission of feedback telegram ?</p>	<p>yes (transm. cyclic and in case of changes)</p> <p>no (transmission only in case of changes)</p>	<p>The object value of the feedback can be transmitted cyclically.</p> <p>The feedback telegram is transmitted to the bus cyclically and after state changes. The cycle time is generally programmed under the "Time settings" entry for all feedback telegrams.</p> <p>The feedback telegram is transmitted to the bus only after state changes.</p> <p>[i] This parameter is visible as an active message object only if feedback is enabled.</p>

 Ax – Enabled functions (x = number of output / All outputs can be parameterized independent of one another.)

Assignment to cyclical monitoring ?	<p>no</p> <p>yes, "ON" when time has elapsed</p> <p>yes, "OFF" when time has elapsed</p>	<p>This parameter determines the assignment to cyclical monitoring of the output.</p> <p>Cyclical monitoring deactivated.</p> <p>Cyclical monitoring activated. The actuator expects a telegram update to the "Switching" object within the monitoring time parameterized under "Time settings". Otherwise, the output will be brought into the predefined contact position and activated when the monitoring time has elapsed.</p> <p>Cyclical monitoring activated. The actuator expects a telegram update to the "Switching" object within the monitoring time parameterized under "Time settings". Otherwise, the output will be brought into the predefined contact position and deactivated when the monitoring time has elapsed.</p> <p>i An output in preferred contact position is not locked so that new telegram updates to the "Switching" object will again be evaluated and processed normally.</p> <p>i The disabling or forced-control position function has a higher priority than the cyclical monitoring function.</p> <p>i When cyclical monitoring is activated, it is not possible to program the functions delay times, staircase timer, logic operation and scene.</p>
Time delays	<p>disabled</p> <p>enabled</p>	<p>This parameter can be used to disable or to enable the time delays. When the function is enabled, the corresponding parameters will be displayed under "Ax - Time delays"</p>
Staircase function	<p>disabled</p> <p>enabled</p>	<p>This parameter can be used to disable or to enable the staircase function. When the function is enabled, the corresponding parameters will be displayed under "Ax - Staircase function" and the necessary object enabled.</p>

Scene function	<p>disabled</p> <p>enabled</p>	<p>This parameter can be used to disable or to enable the scene function. When the function is enabled, the corresponding parameters will be displayed under "Ax - Scenes" and the necessary object enabled.</p>
Operating hours counter	<p>disabled</p> <p>enabled</p>	<p>This parameter can be used to disable or to enable the operating hours counter. When the function is enabled, the corresponding parameters will be displayed under "Ax - Operating hours counter" and the necessary object enabled.</p> <p>i Disabling of the operating hours counter will cause any operating hours counted beforehand to be deleted and limit or start values set via the object for the output concerned to be reset.</p>
Curent measurement	<p>disabled</p> <p>enabled</p>	<p>This parameter can be used to disable or to enable the current measurement function. When the function is enabled, the corresponding parameters will be displayed under "Ax - Current measurement" and the necessary objects enabled.</p>

 Ax – Time delays (x = number of output / only visible if parameter "Time delays" under "Ax – Enabled functions" is set to "enabled"!)

Selection of time delay	<p>no time delay</p> <p>OFF-delay</p> <p>ON-delay</p> <p>ON-delay and OFF-delay</p>	<p>The communication object "Switching" can be evaluated with a time delay. This parameter selects the desired mode of operation of the time delay and enables the other delay parameters.</p>
ON-delay Hours (0...23)	0...23	<p>This parameter is used for programming the duration of the ON-delay</p> <p>Setting the ON-delay hours.</p>
Minutes (0...59)	0...59	<p>Setting the ON-delay minutes.</p>
Seconds (0...59)	0...30...59	<p>Setting the ON-delay seconds.</p> <p><i>Presetting: 30 seconds</i></p>
ON-delay retriggerable ?	<p>yes</p> <p>no</p>	<p>An active ON-delay can be retriggered by another "1" telegram (setting "yes"). Alternatively, retriggering can be excluded (setting "no").</p> <p> The ON-delay parameters are only visible, if the parameter "Selection of time delay" is set to "ON-delay" or to "ON- and OFF-delay".</p>
OFF-delay Hours (0...23)	0...23	<p>This parameter is used for programming the duration of the OFF-delay</p> <p>Setting the OFF-delay hours.</p>
Minutes (0...59)	0...59	<p>Setting the OFF-delay minutes.</p>
Seconds (0...59)	0...30...59	<p>Setting the OFF-delay seconds.</p> <p><i>Presetting: 30 seconds</i></p>

OFF-delay retriggerable ? yes
 no

An active OFF-delay can be retriggered by another "0" telegram (setting "yes"). Alternatively, retriggering can be excluded (setting "no").

i The OFF-delay parameters are only visible, if the parameter "Selection of time delay" is set to "OFF-delay" or to "ON- and OFF-delay".

Supplementary function
for staircase function

The staircase function can be enlarged by two supplementary functions to be used alternatively. This parameter enables the desired supplementary function and activates the necessary parameters or objects.

no supplementary function

No supplementary function enabled.

time extension

Time extension is activated. This function permits retriggering an activated staircase lighting time span n-times via the object "Staircase function start/stop.

time preset via the bus

Time preset via the bus is active. With this supplementary function, the parameterized staircase time can be multiplied with a factor received from the bus and thus dynamically adapted.

Max. time extension

1-gang
2-gang
3-gang
4-gang
5-gang

In case of a time extension (retriggering the lighting time n-times via the object "Staircase function start/stop), the parameterized staircase lighting time will be extended by the value programmed in this parameter.

1-gang extension means that the started staircase time can be automatically retriggered at maximum one more time after elapsing. The lighting time is thus doubled.

The other setting options apply analogously.

i This parameter is visible only when the supplementary function "Time extension" is active.

Staircase function activatable via object "Staircase function factor"?	yes no	<p>In case of time preset via the bus, this parameter can be used to define whether the reception of a new time factor also starts the ON-time of the staircase function as well. The object "Staircase function start/stop" is then hidden.</p> <p>When the setting is "no", the ON-time can only be activated via the object "Staircase function start/stop".</p> <p>i This parameter is visible only when the supplementary function "Time preset via the bus" is active.</p>
Activate ON-delay for staircase function ?	yes no	<p>The staircase function permits activating its own ON-delay. This ON-delay function acts on the trigger event of the staircase function and therefore delays switching on.</p> <p>The ON-delay is enabled.</p> <p>The ON-delay is disabled.</p> <p>i The ON-delay parameterized under this item is independent of the other time functions of the actuator. It only acts on the staircase function and not on the "Switching" object.</p>
ON-delay Hours (0...23)	0...23	<p>This parameter is used for programming the duration of the ON-delay</p> <p>Setting the ON-delay hours.</p>
Minutes (0...59)	0...59	<p>Setting the ON-delay minutes.</p>
Seconds (0...59)	0... 30 ...59	<p>Setting the ON-delay seconds.</p> <p><i>Presetting: 30 seconds</i></p>

ON-delay retriggerable ?	<p>yes</p> <p>no</p>	<p>An active ON-delay can be retriggered (setting "yes"). Alternatively, retriggering can be excluded (setting "no").</p> <p>i This parameter is fixed to "no", when the supplementary function "Time extension" is parameterized. In this case, retriggering is not possible.</p> <p>i The ON-delay parameters are only visible, if the parameter "Activate ON-delay for staircase function ?" is set to "yes".</p>
Activate pre-warning time ?	<p>yes</p> <p>no</p>	<p>When the staircase time of a staircase timer function has elapsed, the output can activate the pre-warning function. The pre-warning function is designed to warn a person in the staircase that the lights will go out shortly.</p> <p>The pre-warning function is activated.</p> <p>The pre-warning function is deactivated.</p>
Pre-warning time Minutes (0...59)	0...59	<p>This parameter is used for programming the duration of the pre-warning time. The pre-warning time is added to the staircase lighting time. Pre-warnings (shutting off the output) will be generated only within the pre-warning time.</p> <p>Setting the pre-warning time minutes.</p>
Seconds (0...59)	0...30...59	<p>Setting the pre-warning time seconds.</p> <p><i>Presetting: 30 seconds</i></p> <p>i A pre-warning time is aborted by retriggering of the staircase function.</p>
Number of pre-warnings (1...10)	1...3...10	<p>This parameter defines how often the output is to switch off within the pre-warning time. i.e. how many pre-warnings will be generated.</p>

Time for pre-warning interruptions
Seconds (0...59)

0...59

This parameter defines the duration of a pre-warning interruption, i.e. how long the output is to remain off during a pre-warning interruption. The time should be adapted individually to the shut-off behaviour of the lamp type used.

Setting the pre-warning interruption seconds.

Milliseconds (0...9 x 100)



0...5...9

Setting the pre-warning interruption milliseconds.

Presetting: 500 milliseconds



- i** It must be ensured that the "Number of pre-warnings" and the "Time for pre-warning interruptions" are coordinated with the length of the total "pre-warning time". Thus, the total shut-off phase during a pre-warning ("Number of pre-warnings" + "Time for pre-warning interruptions") must not be chosen longer than the pre-warning time itself. Otherwise risk of malfunctions.
- i** The actuator takes its power supply completely from the bus and switches the output relays only after a sufficient amount of energy has been stored. This means that the switching states cannot always be retained because of the simultaneous state changes occurring when pre-warnings are active on several outputs at the same time. In case of simultaneous pre-warnings on several outputs the number of pre-warnings programmed should therefore be kept conveniently small.

 Ax – Scenes (x = number of output / only visible if parameter "Scene function" under "Ax – Enabled functions" is set to "enabled"!)

<p>Delay scene recall ?</p>	<p>yes</p> <p>no</p>	<p>A scene is recalled via the scene extension object. If needed, the scene recall on the actuator can be made with a delay after reception of a recall telegram (setting: "yes"). The recall is alternatively made immediately on reception of the telegram (setting: "no").</p> <p> A recall delay has no influence on the storage of scene values.</p>
<p>Delay time Minutes (0...59)</p>	<p>0...59</p>	<p>This parameter is used for programming the duration of delay time</p> <p>Setting the delay time hours.</p>
<p>Seconds (0...59)</p>	<p>0...10...59</p>	<p>Setting the delay time seconds.</p> <p><i>Presetting: 10 seconds</i></p> <p> The parameters are only visible, if the parameter "Delay scene recall ?" is set to "yes".</p>
<p>Overwrite values stored in the device during download ?</p>	<p>yes</p> <p>no</p>	<p>During storage of a scene, the scene values (current states of the outputs concerned) are stored in the device memory. To prevent the stored values from being replaced during ETS programming of the application or of the parameters by the originally programmed scene switching states, the actuator can inhibit overwriting of the scene values (setting: "no"). As an alternative, the original values can be reloaded into the device during each ETS programming (setting: "yes").</p>



<p>Scene X activatable by scene number (scene number "0" = scene deactivated)</p>	<p>0...64; 1*</p> <p><i>*: The predefined scene number is dependent on the scene (1...8).</i></p>	<p>The actuator distinguishes between up to 8 different scenes which are recalled via the scene extension object or stored. The datapoint type of the extension object permits addressing of up to 64 scenes max.</p> <p>This parameter defines the scene number (1...64) which is used to address the internal scene.</p> <p>A setting of "0" deactivates the corresponding scene.</p>
<p><i>X = depending on the scene (1...8)</i></p>		
<p>Switching state for scene X</p>	<p>switching on</p> <p>switching off</p>	<p>This parameter is used for programming the switching command which is executed when the scene is recalled.</p>
<p><i>X = depending on the scene (1...8)</i></p>		
<p>Storage function for scene X</p>	<p>yes</p> <p>no</p>	<p>The "yes" setting enables the storage function of the scene. If the function is enabled, the current logic switching state (on / off) can be stored internally via the extension object during reception of a scene storage telegram. If "no" is selected, the storage telegrams are rejected.</p>
<p><i>X = depending on the scene (1...8)</i></p>		

 Ax – Operating hours counter (x = number of output / only visible if parameter "Operating hours counter" under "Ax – Enabled functions" is set to "enabled"!)

Type of counter	<p>up-counter</p> <p>down-counter</p>	<p>The operating hours counter can be configured as up counter or down counter. The setting has an influence on the visibility of the other parameters and objects of the operating hours counter.</p>
Limit value preset ?	<p>no</p> <p>yes, as specified in parameter</p> <p>yes, as received via object</p>	<p>If the up counter is used, a limit value can be preset as an option. This parameter defines whether the limit value can be preset in a separate parameter or individually adapted from the bus by an independent communication object. A setting of "no" deactivates the limit value.</p> <p> This parameter is only visible in the configuration "Type of counter = up counter".</p>
Limit value (0...65535 h)	0... 65535	<p>This parameter is used for setting the limit value of the up counter. On reaching this limit value, a "1" telegram is transmitted via the "Runout operating hours counter" object. The counter itself continues to run until the max. count (65535) is reached and stops.</p> <p> This parameter is only visible, if the parameter "Limit value preset ?" is set to "yes, as specified in parameter".</p>
Start value preset ?	<p>no</p> <p>yes, as specified in parameter</p> <p>yes, as received via object</p>	<p>If the down counter is used, a start value can be preset as an option. This parameter defines whether the start value can be preset in a separate parameter or individually adapted from the bus by an independent communication object. A setting of "no" deactivates the start value.</p> <p> This parameter is only visible in the configuration "Type of counter = down counter".</p>

Start value (0...65535 h)	0... 65535	<p>This parameter is used for setting the start value of the down counter. After the initialization, the counter begins to decrement the hours from the preset value to "0". After reaching the final value, a "1" telegram is transmitted via the "Runout operating hours counter" object.</p> <p>i This parameter is only visible, if the parameter "Start value preset ?" is set to "yes, as specified in parameter".</p>
Automatic transmission of counting value	cyclical transmission	<p>The current count of the operating hours counter can be actively transmitted to the bus via the communication object "Operating hours counter value".</p> <p>The count is transmitted to the bus cyclically and after a change. The cycle time is programmed under the "Time settings" entry for all outputs in common.</p>
	after change by interval value	<p>The count is transmitted to the bus only after a change.</p>
	Counting value interval (1...65535 h)	1...65535

 Ax – Current measurement (x = number of output / only visible if parameter "Current measurement ?" under "Ax – Enabled functions" is set to "enabled"!)

<p>Transmit current intensity in case of value change ?</p> <p style="text-align: right;">yes no</p>	<p>The actuator can transmit the measured current intensity value of the output concerned as soon as the current intensity has changed (setting "yes"). If the setting is "no", the current intensity will not be transmitted automatically in case of value change.</p>
<p>Transmit in case of value change by (100...16000 mA)</p> <p style="text-align: right;">100...200...16000</p>	<p>In the event of automatic transmission of the current intensity, this parameter can be used to define the value by which the current must change until transmission takes place.</p> <p> This parameter is only visible, if the parameter "Transmit current intensity in case of value change ?" is set to "yes".</p>
<p>Cyclical transmission of current intensity value ?</p> <p style="text-align: right;">yes (cycle time on "Time settings" page) no</p>	<p>In addition to the transmission in case of value change, the actuator can transmit the measured current of the respective output also cyclically (setting "yes"). If the setting is "no", the current intensity will not be transmitted cyclically.</p> <p> The cycle time is generally programmed for all outputs on the "Time settings" parameter page.</p>
<p>Load monitoring</p> <p style="text-align: right;">none with teach-in with fixed load limits</p>	<p>This parameter can be used to enable the load monitoring function. The parameter is also be used to specify the load definition limit. The other parameters are enabled depending on this setting.</p> <p>Load monitoring is deactivated.</p> <p>Load monitoring works with learnt current intensity value and limit values derived therefrom.</p> <p>Load monitoring works with fixed parameterized load limits.</p>

<p>Time delay for current measurement after switching event (0...59 s)</p>	<p>0...3...59</p>	<p>With the load monitoring function enabled, the load current and the load limits after a switching event are measured only after the time parameterized in this entry has elapsed. The function permits, for instance, debouncing of switch-on currents.</p> <p>i This parameter is only visible, if the parameter "Load monitoring" is set to "with teach-in" or "with fixed load limits".</p>
<p>Report overload condition ?</p>	<p>yes no</p>	<p>This parameter enables the monitoring of the upper load limit.</p> <p>i This parameter is only visible, if the parameter "Load monitoring" is set to "with teach-in" or "with fixed load limits".</p>
<p>Current intensity value at upper limit (in % of the teach-in value)</p>	<p>110 % 120 % 130 % 140 % 150 % 160 % 170 % 180 % 190 % 200 %</p>	<p>This parameter defines the current intensity value at the upper limit. The limit value is derived from the value learnt by teach-in and based on the parameterized percentage.</p> <p>Limit value = teach-in value * parameterized value / 100</p> <p>i The limit is dynamically adapted to max. 16 A, if the combination of the learnt current intensity value and the parameterized upper limit results in a value greater than 16 A.</p> <p>i This parameter is only visible, if the parameter "Load monitoring" is set to "with teach-in" and if the parameter "Report overload condition ?" is set to "yes".</p>
<p>Current intensity value at upper limit (250...16000 mA)</p>	<p>250...15000...16000</p>	<p>This parameter defines the current intensity value at the upper limit. The limit value is preset as a fixed value.</p> <p>i This parameter is only visible, if the parameter "Load monitoring" is set to "with fixed load limits" and if the parameter "Report overload condition ?" is set to "yes".</p>

Hysteresis at upper limit 0...**10**...100
(0...100 %)

To increase the noise immunity during reporting (suppression of small current fluctuations), a hysteresis can be separately specified for each current limit. The hysteresis is defined by the fixed parameter value relative to the upper current limit.

- i When specifying the hysteresis parameters make sure that the hysteresis currents derived from the upper and lower limit values do not overlap. Otherwise risk of malfunction → upper hysteresis limit > lower hysteresis limit.
- i This parameter is only visible, if the parameter "Load monitoring" is set to "with teach-in" or "with fixed load limits" and if the parameter "Report overload condition ?" is set to "yes".

Telegram in case of overload

This parameter defines the polarity of the overload message telegram.

**exceed=1 /
fall below – hysteresis=0**

A "1"-telegram is transmitted when the upper limit is exceeded. The actuator transmits a "0"-telegram (inverted message telegram) only if the current falls below the hysteresis level of the upper limit.

**exceed=0 /
fall below – hysteresis=1**

A "0"-telegram is transmitted when the upper limit is exceeded. The actuator transmits a "1"-telegram (inverted message telegram) only if the current falls below the hysteresis level of the upper limit.

- i This parameter is only visible, if the parameter "Load monitoring" is set to "with teach-in" or "with fixed load limits" and if the parameter "Report overload condition ?" is set to "yes".

Report underload condition ?

Yes

This parameter enables the monitoring of the lower load limit.

No

- i This parameter is only visible, if the parameter "Load monitoring" is set to "with teach-in" or "with fixed load limits".

<p>Current intensity value at lower limit (in % of the teach-in value)</p>	<p>90 % 80 % 70 % 60 % 50 % 40 % 30 % 20 % 10 % 0 %</p>	<p>This parameter defines the current intensity value at the lower limit. The limit value is derived from the value learnt by teach-in and based on the parameterized percentage. Limit value = teach-in value * parameterized value / 100</p> <p>i This parameter is only visible, if the parameter "Load monitoring" is set to "with teach-in" and if the parameter "Report underload condition ?" is set to "yes".</p>
<p>Current intensity value at lower limit (250...16000 mA)</p>	<p>250...1000...16000</p>	<p>This parameter defines the current intensity value at the lower limit. The limit value is preset as a fixed value.</p> <p>i This parameter is only visible, if the parameter "Load monitoring" is set to "with fixed load limits" and if the parameter "Report underload condition ?" is set to "yes".</p>
<p>Hysteresis at lower limit (0...100 %)</p>	<p>0...10...100</p>	<p>To increase the noise immunity during reporting (suppression of small current fluctuations), a hysteresis can be separately specified for each current limit. The hysteresis is defined by the fixed parameter value relative to the lower current limit.</p> <p>i When specifying the hysteresis parameters make sure that the hysteresis currents derived from the upper and lower limit values do not overlap. Otherwise risk of malfunction → upper hysteresis limit > lower hysteresis limit.</p> <p>i This parameter is only visible, if the parameter "Load monitoring" is set to "with teach-in" or "with fixed load limits" and if the parameter "Report underload condition ?" is set to "yes".</p>

Telegram in case of
underload

This parameter defines the polarity of the
underload message telegram.

**exceed + hysteresis=0 / fall
below=1**

A "1"-telegram is transmitted when the
current falls below the lower limit. The
actuator transmits a "0"-telegram (inverted
message telegram) only if the current falls
below the hysteresis level of the lower limit.

exceed + hysteresis=1 / fall
below=0

A "0"-telegram is transmitted when the
current falls below the lower limit. The
actuator transmits a "1"-telegram (inverted
message telegram) only if the current falls
below the hysteresis level of the lower limit.

i This parameter is only visible, if the
parameter "Load monitoring" is set to
"with teach-in" or "with fixed load limits"
and if the parameter "Report underload
condition ?" is set to "yes".

 Ax – Supplementary functions (x = number of output)

<p>Selection of supplementary function</p>	<p>no supplementary function</p> <p>disabling function</p> <p>forced-control position</p>	<p>This parameter can be used to define and to enable the supplementary function. The disabling function can only be parameterized as an alternative to the forced-control position function.</p>
<p>Polarity of disable object</p>	<p>0 = enabled; 1 = disabled</p> <p>1 = enabled; 0 = disabled</p>	<p>This parameter defines the polarity of the disabling object.</p> <p> After bus voltage return or programming of the application or of the parameters with the ETS, the disabling function is always deactivated (object value "0"). In the inverted setting ("1 = enabled; 0 = disabled"), a "0" telegram update must first be sent after the initialization before the disabled state can be activated.</p>

Behaviour at the beginning of the disabling function

The behaviour of the output at the beginning of the disabling function can be parameterized.

no change of switching state

At the beginning of the disabling function, the relay of the output shows no reaction and remains in the current switching state. Thereafter, the output is locked.

switching off

The output switches off at the beginning of the disabling function and goes into lock.

switching on

The output switches on at the beginning of the disabling function and goes into lock.

blinking

The output blinks on and off during disabling and is locked during this time. The blinking time is generally parameterized for all outputs under "General". During blinking, the logic switching state is "ON - 1".

i Blinking: The actuator takes its power supply completely from the bus and switches the output relays only after a sufficient amount of energy has been stored. In case of blinking with short blinking rate this means that switching states cannot always be tracked because of the simultaneous state changes in several outputs. For this reason, it is important to program sufficiently long blinking rate if several outputs are to blink at the same time.

i An output disabled via the bus can still be operated by hand!

i This parameter is only visible, if the parameter "Selection of supplementary function" is set to "disabling function".

Behaviour at the end of the disabling function:

	The behaviour of the output at the end of the disabling function can be parameterized.
no change of switching state	At the end of disabling, the internal switching state is not changed. Thereafter, the output is again enabled.
switching off	At the end of disabling, the switching state is set to off. The output is re-enabled.
switching on	At the end of disabling, the switching state is set to on. The output is re-enabled.
setting tracked state	At the end of disabling, the last switching state existing before the disabling function or the switching state internally tracked during the disabling function will be set. In this case, residual times of time functions or of the staircase functions will be tracked as well, if they have not completely elapsed at the time of re-enabling the disabling function.
blinking	<p>At the end of disabling, the output blinks on and off and is re-enabled. Blinking persists until a new switching state is set. The blinking time is generally parameterized for all outputs under "General". During blinking, the logic switching state is "ON - 1".</p> <p>i Blinking: The actuator takes its power supply completely from the bus and switches the output relays only after a sufficient amount of energy has been stored. In case of blinking with a short blinking interval this means that switching states cannot always be tracked because of the simultaneous state changes in several outputs. For this reason, it is important to program sufficiently long blinking intervals if <u>several outputs</u> are to blink at the same time.</p> <p>i This parameter is only visible, if the parameter "Selection of supplementary function is set to "disabling function".</p>

Behaviour at the end of
the forced-control
position

The behaviour of the output at the beginning of a forced-control position function is directly determined by the forced-position telegram. The behaviour of the output at the end of the forced-control position function can be parameterized.

tracking the switching state

At the end of the forced-control position function, the output will be set to the switching state last existing before forced control or to the one tracked internally while forced control was active. In this case, residual times of time functions or of the staircase functions will be tracked as well, if they have not completely elapsed at the time of re-enabling the disabling function.

**no change of switching
state**

At the end of the forced-control position function, the internal switching state will not be changed. Thereafter, the output is again enabled.

switching off

At the end of the forced-control position function, the switching state is set to off. The output is re-enabled.

switching on

At the end of the forced-control position function, the switching state is set to on. The output is re-enabled.

i This parameter is only visible, if the parameter "Selection of supplementary function" is set to "forced-control position".

Behaviour after bus
voltage return

The communication object of the forced-control position function can be initialized after bus voltage return. The switching state of the output can be influenced when the forced-control position function is activated.

no forced-control position

No forced-control position activated after bus voltage return.

activate forced-control
position, ON

Forced-control position activated. Output re-enabled.

deactivate forced-control
position, OFF

Forced-control position activated. The output will be switched off by forced control.

state of forced-control as
before bus voltage failure

The output is set to the forced control state which was stored in a non-volatile memory at the time of bus voltage failure. After programming of the application or of the parameters with the ETS, the value is internally set to "not active".

i After programming of the application or of the parameters with the ETS, the forced-control position is always cancelled.

i This parameter is only visible, if the parameter "Selection of supplementary function" is set to "forced-control position".

Logic operation function ? yes

This parameter can be used to enable the logic operation function (setting "yes"). After enabling, the logic operation object and the parameters of the function are visible.

no

i The parameter is fixed to "no", when the staircase lighting timer or the cyclical monitoring functions are enabled.

<p>Type of logic operation</p>	<p>OR</p> <p>AND</p> <p>AND with feedback</p>	<p>This parameter defines the type of the logic operation.</p> <p>i "AND with feedback:" With a logic object = "0", the output is <u>always</u> "0" (logic AND). In this case, the feedback signal from the output to the "switching" input will directly reset this input when it is being set. Only if the logic operation object = "1", can the output adopt the logic state "1" after a new "1" has been received on the "Switching" input.</p> <p>i This parameter is only visible, if the parameter "Logic operation function ?" is set to "yes".</p>
<p>Value of logic operation object after bus voltage return</p>	<p>0 (OFF)</p> <p>1 (ON)</p>	<p>If logic operation is enabled, the parameter can be used to determine the value with which the logic operation object will be initialized after bus voltage return.</p> <p>i This parameter is only visible, if the parameter "Logic operation function ?" is set to "yes".</p>
<p>Value of logic operation object after ETS download</p>	<p>0 (OFF)</p> <p>1 (ON)</p>	<p>If logic operation is enabled, the parameter can be used to determine the value with which the logic operation object will be initialized after ETS programming.</p> <p>i This parameter is only visible, if the parameter "Logic operation function ?" is set to "yes".</p>

Actuators

Switching/Blind Control

1

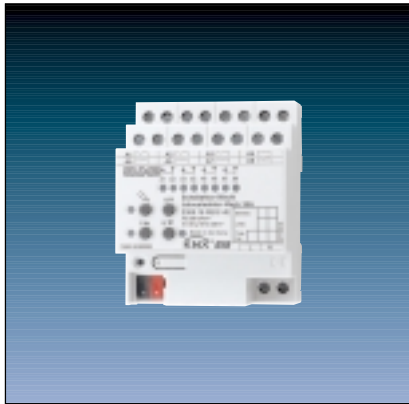

2

	Ref.-No.
KNX Switch/blinds actuator	
Switch 8-gang, Blinds 4-gang	2308.16 REGHE
Switch 16-gang, Blinds 8-gang	2316.16 REGHE
ETS-product family:	Output
Product type:	Binary output
Series embodiment (SE)-device (4/8 units)	

3

The switching actuator receives telegrams from sensors or other controls via the KNX and switches electrical loads by its independent contacts. The relay outputs can be adjusted alternatively to switching or blinds operation by the software.

Also a mixed switching/blinds operation is possible.

Within the blinds operation, the actuator can operate blinds, shutters, awnings, ventilation flaps, curtains or other drives for 230V AC.

In the switching mode it operates e.g. lighting applications or also low voltages.

Each output has a line voltage supplied mono stable relay. This way also preferred positions can be adjusted even at bus voltage drop.

By means of the 4 push-buttons on top of the device, the relays can be operated by hand in parallel to the KNX without bus voltage or programming.

Within the blinds operation mode, the functional scope includes separate adjustable driving times, advanced acknowledge functions, assignments to up to 5 safety functions, an extensive sun protection as well as scenarios and forced position functions.

Also a central control of all blinds outputs is possible.

Within the switching mode, the functional scope for each output channel includes extensive time functions, logics, scenarios or inhibit-functions and advanced acknowledge functions.

Also the central switching of all outputs is possible.

For projecting and commissioning the use of ETS 3.0d is recommended. Only with this ETS version or later versions the full functionality will be available (vd4-file).

For ETS2 and older versions of ETS3 separate databases are available (vd2-file).

4

Technical data

KNX Supply

Voltage:	21 – 32 V DC (SELV)
Power consumption:	typically 150 mW
Connection:	Bus terminal (KNX Type 5.1)

Protection:	IP 20
Safety class:	III
Mark of approval:	KNX/VDE
Ambient temperature:	-5°C ... +45°C
Storage/transport temperature:	-25°C ... +70°C (storage above +45°C results in shorter lifetime)
Mounting position:	any, recommended: output terminals on top
Minimum spacings:	none
Fastening:	on DIN rail 35 x 7.5

4	Technical data	
External supply:	230 – 240 V AC \pm 10 %, 50/60 Hz	
Connection:	Screw terminals:	0.5 mm ² to 4 mm ² , solid or finely stranded conductor without wire end sleeve 0.5 mm ² to 2.5 mm ² , finely stranded conductor with wire end sleeve
Total power loss:	8/4-gang actuator:	max. 3 W
	16/8-gang actuator:	max. 4.5 W
Behavior at bus voltage drop/ recovery:	Depending on parameter	
Behavior at line voltage drop:	Outputs switch Off (Stop)	
Behavior at line voltage recovery:	Depending on parameter	
Output Switch/blind actuator 4/8-gang Number:	4 / 8	
Output Switch/blind actuator 8/16-gang Number:	8 / 16	
Type:	μ -contact, monostable (interlocked by software in blinds mode)	
Rated voltage:	230 – 240V AC, \pm 10 %, 50/60 Hz	
Rated current AC:	16 A / AC-1, 10 A / AC 3, 16 AX	
Max. switch On current:	800 A, 200 μ s / 165 A, 20 ms	
Min. switch current:	100 mA	
Total current actuator:	4/8-gang: max. 80 A, 8/16-gang: max. 160 A	
Total current neighbored channels:	max. 20 A	
Switching Capacities		
Ohmic loads:	3000 W	
Capacitive loads:	16 A, max. 140 μ F	
Motor loads:	1380 VA	
Lamps		
Incandescent:	3000 W	
HV- halogen:	2500 W	
LV- halogen		
Conventional transformers:	1200 VA	
Tronic transformer:	1500 W	
Fluorescent T5 / T8		
not compensated	1000 W	
parallel compensated	1160 W, 140 μ F	
duo-circuit	2300 W, 140 μ F	
Compact fluorescent		
not compensated:	2500 W	
parallel compensated:	1160 W, 140 μ F	
Mercury-arc lamp		
not compensated:	1000 W	
parallel compensated:	1160 W, 140 μ F	
Ballasts:	The number of ballasts depends on the manufacturer and the type and the quality of the LV-net. The given figures are just examples. (Manufacturer: OSRAM)	
	Max. number per output:	
	T8 Lamps:	QTP 2 x 58 W 11
	T5 Lamps:	QT-FH 4 x 14 W 10
		QT-FQ 2 x 54 W 11
Notes:		
	<ul style="list-style-type: none"> • Different lines can be connected to the device. • Do not connect three phase motors. 	

4 Operation

The actuator offers a manual operation for all outputs via 4 push buttons and 3 status LED on the top.

The following operation modes can be adjusted:

- bus operation : operation via push button sensors or other bus-devices
- temporary hand-operation: manual operation via push buttons on top, automatic return to bus-operation
- permanent hand-operation: manual operation via push buttons on top

The operation modes can be released or blocked by parameter.

During hand-operation is no bus-operation possible.

The hand-operation is only possible with line supply connected. At bus voltage recovery or line voltage drop the active hand operation will be stopped.

During bus-operation the hand-operation can be blocked by a telegram, the hand operation will be stopped.

Functional scope:

General

- The outputs can be used for switching or blinds – operation. In the blinds-operation two neighbored outputs will be combined to one blinds channel. A mixed operation is possible.
- The reaction at bus voltage drop and recovery and after ETS-download can be adjusted for each output.
- Active acknowledges can be globally delayed after bus voltage recovery.
- Hand-operation independent from the bus with LED status display.
- Each output has the full functionality. All channel orientated functions can be parameterized for each output separately.

Blinds-operation

- Control of blinds with louver, rolling shutter, awnings or ventilation flaps.
- Separate adjustable driving times – with driving time prolongation for drives in the upper endposition – for each channel.
- Adjustable time for louver adjustment.
- Blocking time at change of driving direction and the times for short and long operation (step, move) adjustable.
- Central control of all blinds channels via 1bit move telegram.
- Acknowledge of the blind and louver position (only during bus-operation).
- Assignment on up to 5 safety functions (3 wind, 1 rain, 1 frost alarm) with or without cyclical monitoring.
- An advanced sun-protection function with fixed or variable position for the blinds and the louver at the beginning or at the end of the function can be adjusted for each output.
- Forced position for each output (with ETS3.0d).
- Up top 8 internal scenarios per output (with ETS3.0d).

Switch-operation

- Switching of independent channels.
- Outputs can be adjusted as make or brake contacts.
- Central switching function with collective acknowledge.
- Acknowledge switching (only bus operation): Active (at changing of the output status) or passive (object can be read out).
- Logic functions for each output.
- Inhibit function for each output, alternatively forced position function.
- Time functions (Switch-on- and Switch-off-delay, staircase-function also with advance warning).
- Light scenes possible, up to 8 internal scenes per output.

5 Description of software application

Objects

Number of addresses:	254
Number of assignments:	255
Communication objects:	4/8 -gang: 74 8/16 -gang: 138

Superior channel objects:

Object	Function	Name	Type	DP-Type	Flag
Function: Hand-operation					
0	Inhibit	Hand-operation	1 Bit	1.003	C, W, -, (R) ¹
Description: 1 Bit object for inhibiting the hand-operation. The polarity can be defined.					
Function: Hand-operation					
1	Status	Hand-operation	1 Bit	1.002	C, T, R ¹
Description: 1 Bit object for transmitting the status of the hand-operation.					

¹: Objects marked (R) permit read-out of the object status (set R flag).

5	Object	Function	Name	Type	DP-Type	Flag		
	Central function blinds (blinds-operation)							
	□ ₂	Drive Central	All outputs	1 Bit	1.008	C, T, R ¹		
	Description:	1 Bit object for central drive (move) of all assigned outputs. The polarity can be defined.						
	Safety function (blinds-operation)							
	□ ₃	Wind alarm ²	Safety blinds	1 Bit	1.005	C, T, R ¹		
	Description:	1 Bit object for central activation/deactivation of wind alarm. ¹						
	Function: Safety function (blinds-operation)							
	□ ₄	Wind alarm ²	Safety blinds	1 Bit	1.005	C, T, R ¹		
	Description:	1 Bit object for central activation/deactivation of wind alarm. ²						
	Function: Safety function (blinds-operation)							
	□ ₅	Wind alarm 3	Safety blinds	1 Bit	1.005	C, T, R ¹		
	Description:	1 Bit object for central activation/deactivation of wind alarm. ³						
	Function: Safety function (blinds-operation)							
	□ ₆	Rain alarm	Safety blinds	1 Bit	1.005	C, T, R ¹		
	Description:	1 Bit object for central activation/deactivation of the rain alarm.						
	Function: Safety function (blinds-operation)							
	□ ₇	Frost alarm	Safety blinds	1 Bit	1.005	C, T, R ¹		
	Description:	1 Bit object for central activation/deactivation of the frost alarm.						
	Function: Central function switching (switch-operation)							
	□ ₈	Central switching	All outputs	1 Bit	1.001	C, T, R ¹		
	Description:	1 Bit object for central switching of all assigned outputs. The polarity can be defined.						
	Function: Collective acknowledge (switch-operation)							
	□ ₉	Collective acknowledge	All outputs	4 Byte	27.001	C, T, R ¹		
	Description:	4 Byte object for central acknowledge of the entire status of the actuator						
	Channel objects, switch-operation:							
	Function: Switching							
	□ _{10, 23 ...}	205 ³	Switching	Output 1 – 16 ³	1 Bit	1.001	C, W, –, (R) ¹	
	Description:	1 Bit object for controlling an output. ("1" = switch On / "0" = switch Off; please note the operation model).						
	Function: Forced position (only with ETS3.0d and upwards)							
	□ _{11, 24 ...}	206 ³	Forced position	Output 1 – 16 ³	2 Bit	2.001	C, W, –, (R) ¹	
	Description:	2 Bit object for a forced positioning of an output. The object status after bus voltage recovery can be defined by parameter.						
	Function: Inhibit							
	□ _{12, 25 ...}	207 ³	Inhibit	Output 1 – 16 ³	1 Bit	1.003	C, W, –, (R) ¹	
	Description:	1 Bit object for inhibiting of an output. (The polarity can be defined.)						
	Function: Logic link							
	□ _{13, 26 ...}	208 ³	Logic link	Output 1 – 16 ³	1 Bit	1.002	K, S, –, (R) ¹	
	Description:	1 Bit object for the input of a logic gate of an output. The object value after bus voltage recovery or after ETS-download can be pre-defined by parameter.						
	Function: Stair-case function							
	□ _{14, 27 ...}	209 ³	Stair-case function	Start/Stop	Output 1 – 16 ³	1 Bit	1.010	K, S, –, (R) ¹
	Description:	1 Bit object for activation or deactivation of the stair-case time of the stair-case function of an output ("1" = switch On / "0" = switch Off).						

¹: Objects marked (R) permit read-out of the object status (set R flag).

²: Depending on the parameter, acknowledge objects are either active (T-Flag set) or passive and can be read out (set R-Flag).

³: Number of outputs or communication objects acc. to the chosen device (4-gang = 4 outputs or 8-gang = 8 outputs).

5	Object	Function	Name	Type	DP-Type	Flag	
	Function: Scene function						
	□↓ 16, 29 ...	211 ³	Light scene extension	Output 1 – 16 ³	1 Byte	18.001	K, S, –, (R) ¹
	Description: 1 Byte object for calling up or storing of a scenario						
	Function: Acknowledge switching						
	□↓ 18, 31 ...	213 ³	Acknowledge switching	Output 1 – 16 ³	1 Bit	1.001	K, –, Ü, R ²
	Description: 1 Bit object for the acknowledge of an output status						
	□↓ ("1" = switched On / "0" = switched Off; note operation model!)						
	Channel objects, blinds-operation:						
	Function: Long-operation						
	□↓ 10, 36 ...	192 ³	Long-operation	Output 1/2 –15/16 ³	1 Bit	1.008	C,W, –, (R) ¹
	Description: 1 Bit object for activation of the long-operation (move)						
	Function: Short-operation						
	□↓ 11, 37...	193 ³	Short-operation	Output 1/2 –15/16 ³	1 Bit	1.007	C,W, –, (R) ¹
	Description: 1 Bit object for activation of the short-operation (step)						
	Function: Forced position (only with ETS3.0d and upwards)						
	□↓ 12, 38 ...	194 ³	Forced position	Output 1/2 –15/16 ³	2 Bit	2.001	C,W, –, (R) ¹
	Description: 2 Bit object for a forced positioning of an output. The object status after bus voltage recovery can be defined by parameter.						
	Function: Scene function						
	□↓ 13, 39 ...	195 ³	Light scene extension	Output 1/2 –15/16 ³	1 Byte	18.001	K, S, –, (R) ¹
	Description: 1 Byte object for calling up or storing of a scenario.						
	Function: Sun protection						
	□↓ 18, 44 ...	200 ³	Sun/façade shading	Output 1/2 –15/16 ³	1 Bit	1.002	C W –, (R) ¹
	Description: 1 Bit object for activating/deactivating of sun protection (The polarity can be defined.)						
	Function: Sun protection						
	□↓ 19, 45 ...	201 ³	Position, Sun/facade shading	Output 1/2 –15/16 ³	1 Byte	5.001	C W –, (R) ¹
	Description: 1 Byte object for a variable position (0 ... 255) at active sun-protection.						
	Function: Sun protection						
	□↓ 20, 46 ...	202 ³	Louvers position, Sun/facade shading	Output 1/2 –15/16 ³	1 Byte	5.001	C W –, (R) ¹
	Description: 1 Byte object for a variable louver position (0 ... 255) at active sun-protection.						
	Function: Sun protection						
	□↓ 21, 47 ...	203 ³	Offset louvers position, Sun	Output 1/2 –15/16 ³	1 Byte	5.001	C W –, (R) ¹
	Description: 1 Byte object for presetting a louver position angle (–100 % ... +100 %) for a manual readjustment of the louver position at active sun-protection.						
	Function: Acknowledge position						
	□↓ 24, 50 ...	206 ³	ACK position	Output 1/2 –15/16 ³	1 Byte	5.001	C W –, (R) ¹
	Description: 1 Byte object for the ACK of the blinds, shutter or ventilation flap position (0 ... 255).						

¹ : Objects marked (R) permit read-out of the object status (set R flag).

² : Depending on the parameter, acknowledge objects are either active (T-Flag set) or passive and can be read out (set R-Flag).

³ : Number of outputs or communication objects acc. to the chosen device (4-gang = 4 outputs or 8-gang = 8 outputs).

5	Object	Function	Name	Type	DP-Type	Flag
	Function: Acknowledge position					
	25, 51 ...					
	207 ³	ACK louver position	Output 1/2 -15/16 ³	1 Byte	5.001	C W -, (R) ¹
	Description: 1 Byte object for the ACK louver position (0 ... 255).					
	Function: Acknowledge position					
	26, 52 ...					
	208 ³	ACK invalid position	Output 1/2 -15/16 ³	1 Bit	1.002	C W -, (R) ¹
	Description: 1 Bit object for the ACK of an invalid position.					
	Function: Acknowledge moving					
	27 53 ...					
	209 ³	ACK moving	Output 1/2 -15/16 ³	1 Bit	1.002	C W -, (R) ¹
	Description: 1 Bit object for the ACK of an active movement.					
	Function: Positioning					
	28, 54 ...					
	210 ³	Positioning	Output 1/2 -15/16 ³	1 Byte	5.001	C W -, (R) ¹
	Description: 1 Byte object for setting a position (0 ... 255) at direct operation for the blinds, shutter or ventilation flap.					
	Function: Positioning					
	29, 55 ...					
	211 ³	Positioning	Output 1/2 -15/16 ³	1 Byte	5.001	C W -, (R) ¹
	Description: 1 Byte object for setting a louver position (0 ... 255) at direct operation for the blinds.					

¹: Objects marked (R) permit read-out of the object status (set R flag).

²: Depending on the parameter, acknowledge objects are either active (T-Flag set) or passive and can be read out (set R-Flag).

³: Number of outputs or communication objects acc. to the chosen device (4-gang = 4 outputs or 8-gang = 8 outputs).

Superior channel functions

Delay after bus voltage recovery

In order to reduce the bus-traffic after bus-reset, connecting the devices to the bus or after ETS-download it is possible to delay all active sending acknowledges (ACK). A delay time can be adjusted.

The ACK to be delayed can be adjusted independently for each output and ACK-function.

Central function

All output channels can be linked by a 1-Bit central-communication object. The behaviour is assimilable with a central group address, linked to all switching objects.

Collective acknowledge

After central commands or bus voltage recovery the bus load is normally high as many devices send out an ACK about the status of its communication objects. This especially happens within visualizations. The collective ACK can be used to reduce the bus load.

In the collective ACK all switching status are combined in a 32 Bit communication object.

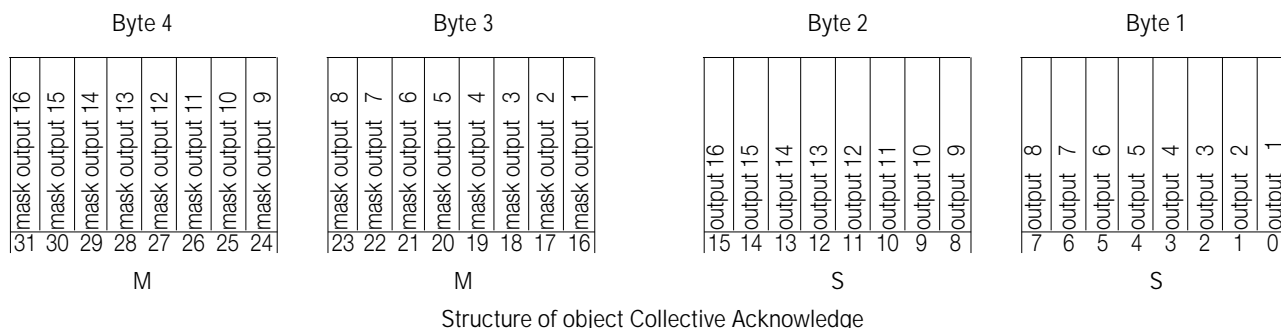

The collective ACK can be used as an active object – will be sent out with each change of a switching status – or as a passive status object – object value can be read out.

Actuators

Shutter/Blind, Flush mounted

1

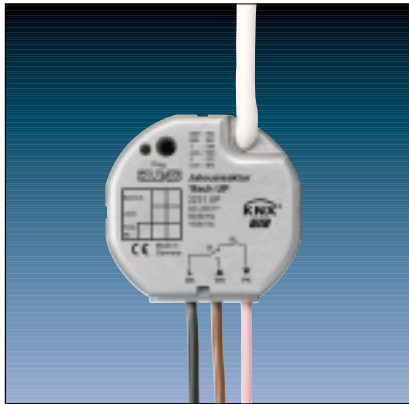

2

	Ref.-No.
KNX blinds actuator, flush mounted	2231 UP
ETS-product family:	Shutter
Product type:	Shutter

3

The shutter/blind actuator receives telegrams from sensors via the KNX and controls a shutter or blind motor with its output. Both travel directions are mechanically interlocked. With sun protection or positioning telegrams, the actuator offers moreover the possibility of moving shutters, blinds and slats into any desired position. On reception of a storm warning, the actuator is capable of moving shutters or blinds into a predefined safety position and to lock them up in this position.

The device is equipped with two extension inputs which – depending on parameterization – can act directly on the shutter/blind output (local control / double-sided push-button principle) or alternatively as binary inputs on the KNX. The connected potential-free switch or push-button contacts are sensed against a common reference potential at the shutter/blind actuator. As a binary input, the device can transmit telegrams for switching or dimming, for shutter/blind control or for value transmitter applications (dimming value transmitter, light-scene extension).

Connecting 230 V signals or other external voltages to the extension inputs is not permitted.

The shutter/blind actuator is supplied from the KNX and needs therefore no additional external power supply.

4

Technical data

KNX supply	
Cable type:	YY 6 x 6.0 mm; red: bus (+) / black: bus (-)
Voltage:	21 – 32 V DC SELV
Power consumption:	typically 150 mW
Connection:	approx. 33 cm ready-made; connecting terminal (0.6 – 0.8 mm)
Type of protection:	IP 20
Safety class:	III
Mark of approval:	KNX
Ambient temperature:	-5°C ... +45°C
Storage/transport temperature:	-25°C ... +70°C (storage above +45°C results in shorter lifetime)
Mounting position:	any
Minimum spacings:	none
Type of fastening:	e.g. placing into deep flush-mounting box (Ø 60 mm x 60 mm)

4 Technical data

Input

Number:	2 (depending on parameterization either as extension inputs for push-button local control of the actuator or as independent binary inputs acting on the bus)
Cable type:	YY 6 x 0.6 mm green: extension input 1 white: reference potential (com) yellow: extension input 2 brown: reference potential (com)
Cable length:	approx. 33 cm ready-made, extendible to 5 m max.
Scanning voltage:	approx. – 19 V DC referred to “com”; continuous signal
Loop resistance:	max. 2 kOhm for safe “1” signal detection (rising edge)

Output

Number:	1
Cable type:	3 x H05 V-K 1.5 mm ² with ferrules
Cable length:	approx. 20 cm ready-made
Switch type:	1 change-over contact + 1 make-contact, potential-free relay contacts (μ-contact), bistable
Switching voltage:	230 V AC; 50/60 Hz
Switching capacity:	max. 1 motor 1000 VA

Note:

- Never connect the mains voltage (230 V) or other external voltages to the extension inputs.
Connecting an external voltage endangers the electrical safety of the entire KNX system (SELV / no electrical insulation).
Persons may be put at risk and devices and installations may suffer irreparable damage.
- Make sure during the installation that there is always sufficient insulation between the mains voltage and the bus or the extensions.
A minimum spacing of 4 mm must be ensured between the bus/extension wires and the mains wires.
- Non-used wires of the 6-wire connecting cable must be insulated with respect to one another and with respect to external voltages.
- To avoid EMC disturbances, the lines to the inputs should not be laid parallel to lines and cables carrying mains voltage.
- If motors are to be connected in parallel to an output, it is absolutely indispensable to observe the corresponding instructions of the motor manufacturers to avoid irreparable damage to the motors. If necessary, use supplementary isolating relays.
- Use only shutters or blinds with end position limit switches (mechanical or electronic). The limit switches of the motors connected must be checked for correct adjustment.

Inputs:

General

- Mode of functioning of the inputs parameterizable:
 - function as extension inputs for double-sided actuation of button acting directly on shutter/blind output,
 - function as general binary inputs acting separately on the bus.

Function as binary inputs to the bus:

- Switching, dimming, shutter/blind and value transmitter functions freely assignable to the max. 2 inputs.
- Disable object for disabling of individual inputs (polarity of disable object presettable).
- Delay on return of bus voltage and debouncing time centrally adjustable.
- Response to bus voltage return separately parameterizable for each input.
- Telegram rate limitation generally parameterizable for all inputs.

Switching function

- Two independent switching objects available for each input (switching commands individually parameterizable).
- Command for rising and falling edge individually adjustable (ON, OFF, TOGGLE, no reaction).
- Independent cyclical transmission of switching objects depending on edge or on object value selectable.

Dimming function

- Single level and two level dimming function.
- Time between dimming and switching and dimming step width presettable.
- Telegram repetition and stop telegram transmission possible.

Stutter/blind function

- Command for rising edge adjustable (no function, UP, DOWN, TOGGLE).
- Operation concept parameterizable (“step – move – step” resp. “move – step”).
- Time between STEP and MOVE operation presettable (only with “step – move – step”).
- Slat adjustment time presettable (time during which a “MOVE” command can be terminated by releasing a push-button on the input).

Value transmitter and light-scene extension functions

- Edge (push-button as n.o. contact, push-button as n.c. contact, switch) and value for edge parameterizable.
- Value change in push-button mode possible with long press on the button for value transmitter.
- In light-scene extension with storage function, a light-scene can be stored without preceding recall.

4 Technical data

Output:

- One channel for a shutter/blind motor.
- Type adjustable (shutter or blind).
- Switch-over delay during travel direction change adjustable.
- Priority assignment to incoming telegrams parameterizable for sun protection and parameterise (STEP / MOVE).
- Automatic sun protection function for brightness-dependent moving of a shutter or blind into a parameterised position.
- Safety function with cyclical checking and assigning to shutter or blind channels.
- Movement into parameterizable limit position on reception of safety message.
- Response to failure and return of bus voltage adjustable.

5 Description of software application

Objects

Number of addresses:	26
Number of assignments:	27
Communication objects:	11

Objects for the binary inputs (extension inputs), if acting on the bus:

Object	Name	Function	Type	Flag
Function: "Switching" (for all 2 inputs ²)				
1 – 2	Input 1 – Input 2	Switching object X.1 (X = 1 to 2)	1 Bit	C, W, T, (R) ¹
9 – 10	Input 1 – Input 2	Switching object X.2 (X = 1 to 2)	1 Bit	C, W, T, (R) ¹
Function: "Dimming" (for all 2 inputs ²)				
1 – 2	Input 1 – Input 2	Switching	1 Bit	C, W, T, (R) ¹
9 – 10	Input 1 – Input 2	Dimming	4 Bit	C, T, (R) ¹
Function: "Shutter/blind" (for all 2 inputs ²)				
1 – 2	Input 1 – Input 2	Short operation	1 Bit	C, T, (R) ¹
9 – 10	Input 1 – Input 2	Long operation	1 Bit	C, T, (R) ¹
Function: "Value transmitter" (Function: Dimming value transmitter for all 2 inputs ²)				
1 – 2	Input 1 – Input 2	Value	1 Byte	C, T, (R) ¹
Function: "Value transmitter" (Function: Light-scene extension with/without storage function for all 2 inputs ²)				
1 – 2	Input 1 – Input 2	Light-scene extension	1 Byte	C, T, (R) ¹
Function: "Disable" (for all 2 inputs ³)				
17 – 18	Input 1 – Input 2	Disabling	1 Bit	C, W, (R) ¹

¹: Objects marked (R) permit read-out of the object status (set R flag).

²: The "No function", "Switching", "Dimming", "Shutter/blind" and "Value transmitter" functions can be selected per input.

The names of the communication objects and the object table (dynamic object structure) will change accordingly.

³: A disable function is not available if the inputs are parameterised for "No function".

Objects for the output:

Object	Name	Function	Type	Flag
0	Shutter/blind	Short operation	1 Bit	C, W, (R) ¹
4	Shutter/blind	Long operation	1 Bit	C, W, (R) ¹
Function: Safety function				
12	Safety 1	Safety function	1 Bit	C, W, (R) ¹
13	Safety 2	Safety function	1 Bit	C, W, (R) ¹
Function: Sun protection function				
8	Sun protection	Sun protection	1 Bit	C, W, (R) ¹

¹: Objects marked (R) permit read-out of the object status (set R flag).

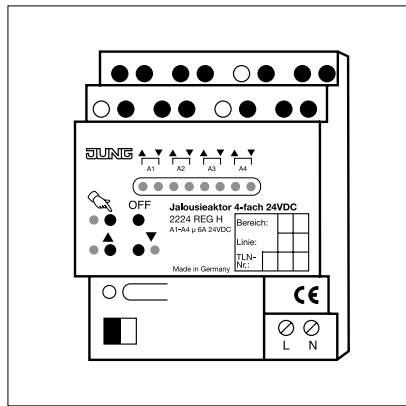

2

	Ref.-No.
KNX blinds actuator,	
4-gang, 24 VDC	2224 REG H
ETS-product family:	Shutter
Product type:	Shutter
Series embodiment (SE)-device (4 units)	

3

The blind / shutter actuator receives telegrams via the KNX and switches four mutually independent channels. Each channel can operate one drive. It is also possible to reduce the outputs to two, in order to control two drives at one output. The actuator offers four push-buttons for manual control. Each output can be controlled manually temporary or permanently, independent of the bus. Additionally, the actuator offers the possibility to drive the shutter or blind and louvres to a calculated position in case of sun-protection, central function or positioning-telegrams. At the receipt of a storm report, the actuator is able to drive and lock the shutter or blind into a defined safety position. The behaviour at bus voltage drop and return can be parameterised.

4

Technical data	
Supplying	
Voltage:	21 – 32 V DC (SELV)
Power consumption:	typical 150 mW
Connection:	KNX connection block
Output	
Number:	4
Performance:	floating make-contacts
Rated voltage:	24 V AC \pm 10%
Rated current:	6 A
Connection:	screw terminals: 0,2 – 4 mm ²
Protection:	IP 20
Behaviour at voltage drop and recovery:	dependent on parameters
Operation temperature:	-5°C ... +45°C
Storage temperature:	-25°C ... +70°C
Mounting:	on DIN rail 35 x 7.5

5 Description of software application

- 4 mutual independent channels, each for one drive.
- 2x2-channel operation possible
- Type of drive is adjustable (blind or shutter).
- The tracing time in case of changing the drive direction can be adjusted.
- A driving time prolongation, in order to match different driving times into the upper end position, is adjustable.
- Possibility to drive the shutter or blind and louvers into a calculated position.
- Positioning can be deactivated.
- The priority of single functions is adjustable.
- Sun protection automatic for brightness depending drive in a calculated position.
- Logical link of the sun protection objects.
- Safety function with cyclical monitoring and assignment to the channels.
- Driving into a parameterised end-position at a safety report.
- Reaction at bus voltage drop and recovery is adjustable.
- Four central functions possible at 2x2-channel operation.
- The current position of the shutter/blind can be transmitted (i.e. for visualization purposes).

Objects

Number of addresses (dynamic):	32
Number of assignments (dynamic):	32
Communication objects:	20

Operation mode: 4 x 1 channel operation

Object	Name	Function	Type	Flag
0	Output 1	Short time operation (step)	1 Bit	C, W
1	Output 2	Short time operation (step)	1 Bit	C, W
2	Output 3	Short time operation (step)	1 Bit	C, W
3	Output 4	Short time operation (step)	1 Bit	C, W
4	Output 1	Long time operation (move)	1 Bit	C, W
5	Output 2	Long time operation (move)	1 Bit	C, W
6	Output 3	Long time operation (move)	1 Bit	C, W
7	Output 4	Long time operation (move)	1 Bit	C, W

Function: Blind

8	Position output 1 blind	Positioning	1 Byte	C, W
9	Position output 2 blind	Positioning	1 Byte	C, W
10	Position output 3 blind	Positioning	1 Byte	C, W
11	Position output 4 blind	Positioning	1 Byte	C, W
12	Position output 1 louvres	Positioning	1 Byte	C, W
13	Position output 2 louvres	Positioning	1 Byte	C, W
14	Position output 3 louvres	Positioning	1 Byte	C, W
15	Position output 4 louvres	Positioning	1 Byte	C, W

Function: Shutter

8	Position output 1 shutter	Positioning	1 Byte	C, W
9	Position output 2 shutter	Positioning	1 Byte	C, W
10	Position output 3 shutter	Positioning	1 Byte	C, W
11	Position output 4 shutter	Positioning	1 Byte	C, W
16	Safety 1	Safety	1 Bit	C, W
17	Safety 2	Safety	1 Bit	C, W
18	Automatic 1	Sun protection	1 Bit	C, W
19	Automatic 2	Sun protection	1 Bit	C, W

5 Objects

Operation mode: 2 x 2 channel operation

Object	Name	Function	Type	Flag
0	Output 1/3	Short time operation (step)	1 Bit	C, W
1	Output 2/4	Short time operation (step)	1 Bit	C, W
2	Central 1	Central	1 Bit	C, W
3	Central 2	Central	1 Bit	C, W
4	Output 1/3	Long time operation (move)	1 Bit	C, W
5	Output 2/4	Long time operation (move)	1 Bit	C, W
6	Central 3	Central	1 Bit	C, W
7	Central 4	Central	1 Bit	C, W
Function: Blind				
8	Position output 1/3 blind	Positioning	1 Byte	C, W
9	Position output 2/4 blind	Positioning	1 Byte	C, W
12	Position output 1/3 louveres	Positioning	1 Byte	C, W
13	Position output 2/4 louveres	Positioning	1 Byte	C, W
Function: Shutter				
8	Position output 1/3 shutter	Positioning	1 Byte	C, W
9	Position output 2/4 shutter	Positioning	1 Byte	C, W
16	Safety 1	Safety	1 Bit	C, W
17	Safety 2	Safety	1 Bit	C, W
18	Automatic 1	Sun protection	1 Bit	C, W
19	Automatic 2	Sun protection	1 Bit	C, W

5 Notes to software application:

Parameter 'Positioning'

This parameter defines the position of the shutter or blinds, if the positioning function, which is, among others, necessary for the sun protection and central function, is released.

If the positioning function is released, an additional set of parameter as: 'moving time shutter', 'moving time louveres' and 'positioning' will be visible. In this case the driving time of a e. g. safety drive in one of the end positions has to be set by the parameters 'moving time shutter' and by the parameter 'driving time prolongation'.

If the positioning function is blocked, only the parameter for 'safety', 'step' and 'move' are adjustable. Now the driving time of a safety drive in one of both end positions is internally fixed at 2 minutes.

Reference drive / positioning

After a bus reset, download or after a 'move' command in none of the end positions, a reference drive (drive to the upper end position) will be carried out in general before the positioning starts.

At sun-protection, central function or positioning, a reference drive can be forced before the shutter/blind drives to the calculated position. This helps to ensure that in case of several controlled drives each drive goes exactly to the same position even if one has been moved before by a 'step' command manually.

The time for a reference drive is fixed by the 'moving time shutter' plus the adjusted 'moving time prolongation'. After the reference drive is carried out, each output drives automatically to its calculated position.

This device has the advantage that the actual position is carried out by the positioning object of the corresponding output each time the blind or shutter has been moved.

Also the actual position is stored in the memory, even after a step command.

Bus voltage drop: tracing time at change of driving direction

At bus voltage drop and a possible change of driving direction (depending on the parameter 'behavior at bus voltage drop') a fixed tracing time of 120 ms will be kept.

Actuators

Shutters / Blinds

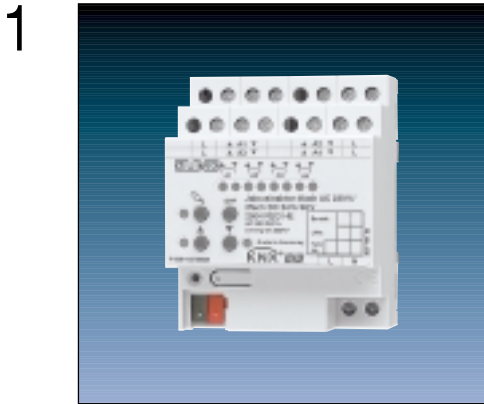

2

	Ref.-No.
KNX shutter/blind actuator	
4-gang 230 V AC / 2-gang 24 V DC	2504 REG HE
ETS-product family:	Shutter
Product type:	Shutter/blind 4-gang
Series embodiment (SE)-device (4 units)	

3

The shutter/blind actuator receives telegrams from sensors or other controls via the KNX and uses its independent relay contacts for switching electrically operated blinds, shutters, awnings, venting louvers or similar devices for 230 V AC mains voltage (4 channels) or extra-low voltage 12 ... 48 V DC (2 channels). Each relay output is equipped with mains-operated monostable switching relays so that the preferred contact positions are maintained also during bus voltage failure.

The 4 manual switches on the front panel of the device permit switching the relays on and off by hand in parallel with the KNX even without bus voltage or in a non-programmed state. This feature permits fast checking of connected motors for proper functioning.

The functionalities that can be preset with the ETS independently for each output channel include, for instance, separately adjustable moving times, an automatic end position detection with 230 V drives with mechanical limit switches as an alternative, enlarged feedback functions, assignment to up to five different safety functions, a sun protection function adapted to a great variety of requirements and the incorporation into scenes or forced-position applications.

Centralized control of all outputs is also available. Moreover, the preferred states of the relays in case of bus voltage failure or bus / mains voltage return and after ETS programming can be preset separately.

For project design and commissioning of this device it is recommended to use the ETS3.0d. The advantages with regard to downloading (shorter loading times) and parameter programming are available only if this ETS version or later versions are used (vd4-file). For the ETS2 and older versions of the ETS3 a separate product database is available (vd2-file).

The shutter/blind actuator has its own mains supply independent of the connected drives. For actuation of the outputs, the mains supply must always be on. The device electronics are supplied from the bus voltage or from the mains voltage.

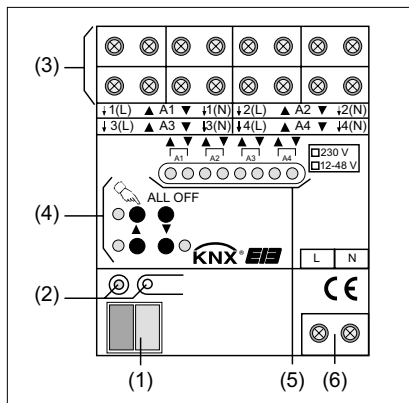

- (1) KNX bus connection
- (2) Programming button and programming LED (red).
The programming LED flashes slowly when the safe-state mode is active.
- (3) Screw terminal for connection of the motors.
- (4) Keypad for manual control with status LED
- (5) Output state LEDs with movement direction indicator (2 LEDs per output):
LED off: output is off
LED on: output on (upward movement "▲" or downward movement "▼")
LED flashing slowly: output controlled manually
LED flashing fast: output disabled by manual control
- (6) Mains voltage terminal for power supply to the device electronics

4 Technical data

KNX supply	
Voltage:	21 ... 32 V DC SELV
Power consumption:	typically 150 mW
Connection:	standard KNX bus connection terminal
External supply	
Voltage:	230 ... 240 V AC $\pm 10\%$, 50/60 Hz
Power consumption:	max. 5.6 VA
Connection:	with screw terminals: 0.5 ... 4 mm ² solid and stranded wire without ferrule 0.5 ... 2.5 mm ² stranded wire with ferrule Max. tightening torque: 0.8 Nm
Total power loss:	max. 4.52 W
Response to bus voltage failure:	depending on parameterization
Response to mains voltage failure:	outputs are shut off (stop)
Response to bus/mains voltage return:	depending on parameterization
Number:	4 / 2 depending on parameterized channel definition (4-channel 230 V) or (2-channel 12...48 V DC).
Connection:	with screw terminals: 0.5 ... 4 mm ² solid and stranded wire without ferrule 0.5 ... 2.5 mm ² stranded wire with ferrule
Type of contact:	μ -contact, monostable, movement directions software-locked
Switching voltage AC:	230...240 V AC $\pm 10\%$, 50/60 Hz
Switching capacity AC 230/240 V	6 A AC1
Min. switching voltage AC:	100 mA
Switching voltage DC:	12 ... 48 V DC
Switching capacity DC:	6 A
Switching capacity DC:	3 A
Min. switching current DC:	100 mA
Type of protection	IP 20
Safety class:	III
Mark of approval:	KNX/VDE
Ambient temperature:	-5 °C ... +45 °C
Storage / transport temperature:	(Storage above + 45 °C reduces the lifetime)
Mounting position:	any position (preferred: output terminals at the top)
Type of fastening:	Snap-fastening on DIN rail in closed cabinets.

5 Application with 230 V drives (without automatic end position detection)

Without the automatic end position detection, the movement times of the different blinds/shutters are programmed in the ETS independent of one another. After commissioning, the preset times can be changed only by reprogramming of the parameters. The shutter actuator must have been preset in the ETS for 4-channel operation.

Note: When the N conductor is connected and when the concerned output is energized without interruption for a prolonged time due to retriggering, the device may heat up excessively. Risk of irreparable damage to the device.
Do not connect the N conductors !

- Connect the drives as shown in fig. A.
- Tick the box "230 V" on the device label.

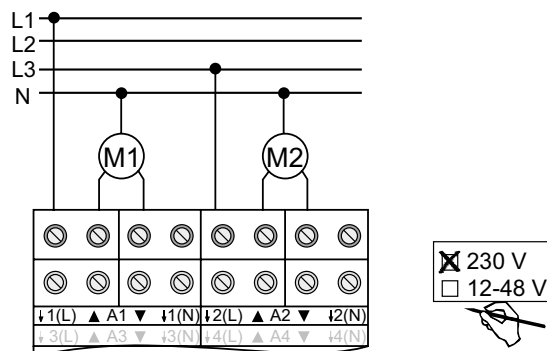

Fig. A: Electrical connection for 230 V drives

5 Application with 230 V drives (without automatic end position detection)

- The device can be used with different phase conductors (L1, L2, L3).
- The N terminals are used only for automatic end position detection and must not be used as neutral potential for other loads in the distribution.
- Venting louvers must be connected in such a way that they open in movement direction "UP – ▲" and close in movement "DOWN – ▼".

Application with 230 V drives (with automatic end position detection)

If programmed and connected accordingly, the shutter actuator auto-detects the movement time of a connected output and stores it. In drives with mechanical limit switches, the actuator measures the voltage against the N conductor (connected to the device) in order to detect the end positions. In operation, the shutter actuator can adapt itself to changes in the travelling times of the drives (e.g. caused by ageing of the motors). The shutter actuator must have been preset in the ETS for 4-channel operation.

The automatic end position detection must have been activated in the ETS for the output concerned. Only 230 V AC drives with mechanical limit switches must be connected to the device. Connect only one drive to each output.

The automatic movement time detection cannot be used for 12 ... 48 V DC drives or for drives with electronic limit switches and for drives connected to the outputs via isolating (decoupling) relays.

The blinds/shutters controlled by the device must not be blocked.

- Connect the drives with mechanical limit switches as shown in fig. B.
- Tick the box "230 V" on the device label.

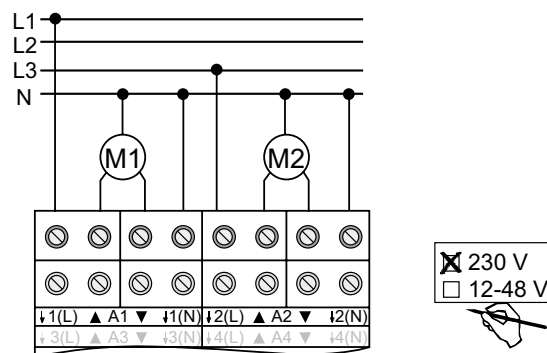

Fig. B: Electrical connection for 230 V drives with automatic end position detection

- The device can be used with different phase conductors (L1, L2, L3).
- The neutral conductor of the respective motor must be connected to the N terminal of the device (pay attention to existing ELCB wiring). The N terminals are used only for automatic end position detection and must not be used as N potential for other loads in the distribution. The N conductor terminals of the individual outputs and of the mains connection terminal are internally not connected.
- When an output is energized without interruption for a prolonged time due to retriggering, the device may heat up excessively.
- The automatic end position detection is performed during commissioning and the detected movement time is permanently stored.
- Venting louvers must be connected in such a way that they open in movement direction "UP – ▲" and close in direction "DOWN – ▼".

Note: Risk of irreparable damage if several drives are connected in parallel to one output. Limit switch contacts can weld together and drives, blinds/shutters and the shutter actuator can be irreparably damaged.

Observe the manufacturer's instructions and use isolating (decoupling) relays, if necessary !

Application with device 12 ... 48 V DC drives (without automatic end position detection)

The movement times of the different blinds/shutters are programmed in the ETS independent of one another. After commissioning, the preset times can be changed only by reprogramming of the parameters. The shutter outputs A1 and A2 (A3 and A4) are paired and used for controlling a DC drive.

The shutter actuator must have been preset in the ETS for 2-channel operation.

5 Application with device 12 ... 48 V DC drives (without automatic end position detection)

- Connect the drives as shown in fig. C.
- Tick the box "12 ... 48 V" on the device label.

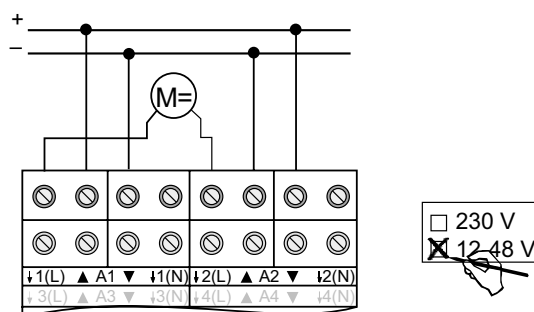

Fig. C: Electrical connection for 12 ... 48 V drives

- Connect only one drive to each output.
- In the 2-channel mode, outputs 1 & 2 and 3 & 4 are paired also in case of manual control.
The status LEDs always indicate the relay states of the paired output.
- Venting louvers must be connected in such a way that they open in movement direction "UP –▲" and close in movement "DOWN –▼".

Description of software application

Objects

Number of communication objects:	84
Number of addresses (max):	254
Number of assignments (max):	255

Channel-independent objects:

Object	Function	Name	Type	DP-Type	Flag
Function: Manual control					
<input type="checkbox"/> 0	Disabling	Manual control	1 Bit	1.003	C, W, –, (R) ¹
Description: 1-bit object for disabling the keys for manual control on the device. The polarity can be parameterized.					
Function: Manual control					
<input type="checkbox"/> 1	Status	Manual control	1 Bit	1.002	C, –, T, (R) ¹
Description: 1-bit object for manual control status transmission The object is "0", when manual control is deactivated (bus control). The object is "1", when manual control is being activated. The user can parameterize whether the temporary or the permanent manual control will be indicated as status information or not.					
Function: Shutter central function					
<input type="checkbox"/> 2	Central travel control	All shutter outputs	1 Bit	1.008	C, W, –, (R) ¹
Description: 1-bit object for central actuation (long-time travel) of assigned shutter outputs The polarity can be parameterized.					
Function: Safety function					
<input type="checkbox"/> 3	Wind alarm 1	Safety	1 Bit	1.005	C, W, –, (R) ¹
Description: 1-bit object for central activation or deactivation of the first wind alarm ("0" = wind alarm deactivated / "1" = wind alarm activated).					
Function: Safety function					
<input type="checkbox"/> 4	Wind alarm 2	Safety	1 Bit	1.005	C, W, –, (R) ¹
Description: 1-bit object for central activation or deactivation of the second wind alarm ("0" = wind alarm deactivated / "1" = wind alarm activated).					
Function: Safety function					
<input type="checkbox"/> 5	Wind alarm 3	Safety	1 Bit	1.005	C, W, –, (R) ¹
Description: 1-bit object for central activation or deactivation of the third wind alarm ("0" = wind alarm deactivated / "1" = wind alarm activated).					

¹ Each communication object can be read out. For reading, the R-flag must be set.

5 Description of software application

Channel-independent objects:

Object	Function	Name	Type	DP-Type	Flag
Function: Safety function					
□↓ 6	Rain alarm	Blind safety	1 Bit	1.005	C, W, -, (R) ¹
Description: 1-bit object for central activation or deactivation of the rain alarm ("0" = rain alarm deactivated / "1" = rain alarm activated).					
Function: Safety function					
□↓ 7	Frost alarm	Safety	1 Bit	1.005	C, W, -, (R) ¹
Description: 1-bit object for central activation or deactivation of the frost alarm ("0" = frost alarm deactivated / "1" = frost alarm activated).					
Channel-oriented objects:					
Function: Long-time operation					
□↓ 10, 36, 62, 88	Long-time operation	Output 1 – 4 ²	1 Bit	1.008	C, W, -, (R) ¹
Description: 1-bit object for activation of the long-time operation					
Function: Short-time operation					
□↓ 11, 37, 63, 89	Short-time operation	Output 1 – 4 ²	1 Bit	1.007	C, W, -, (R) ¹
Description: 1-bit object for activation of the short-time operation or for stopping of a travel movement.					
Function: Forced position					
□↓ 12, 38, 64, 90	Forced position	Output 1 – 4 ²	2 Bit	2.008	C, W, -, (R) ¹
Description: 2-bit object for forced control of an output. The object state after bus voltage return can be predefined by means of a parameter.					
Function: Scene function					
□↓ 13, 39, 65, 91	Scene extension	Output 1 – 4 ²	1 Byte	18.001	C, W, -, (R) ¹
Description: 1-byte object for recalling scenes or for storing new scene values.					
Function: Sun protection function					
□↓ 15, 41, 67, 93	Automatic mode	Output 1 – 4 ²	1 Bit	1.003	C, W, -, (R) ¹
Description: 1-bit object for activation or deactivation of the automatic sun protection in the enlarged sun protection mode ("1" = automatic mode activated / "0" = automatic mode deactivated). The object is only visible, if the automatic sun protection is to be tracked immediately when the state of the automatic object changes (parameter setting).					
Function: Sun protection function					
□↓ 16, 42, 68, 94	Automatic mode disable	Output 1 – 4 ²	1 Bit	1.003	C, W, -, (R) ¹
Description: 1-bit object for disabling of the automatic sun protection in the enlarged sun protection mode. The polarity can be parameterized. The object is only visible, if the automatic sun protection is to be tracked immediately when the state of the automatic object changes (parameter setting).					
Function: Sun protection function					
□↓ 16, 42, 68, 94	Automatic mode	Output 1 – 4 ²	1 Bit	1.003	C, W, -, (R) ¹
Description: 1-bit object for activation or deactivation of the automatic sun protection in the enlarged sun protection mode. The polarity can be parameterized. The object is only visible, if the automatic sun protection is to be tracked only when the state of the automatic object changes next time (parameter setting).					
Function: Sun protection function					
□↓ 17, 43, 69, 95	Disabling direct operation	Output 1 – 4 ²	1 Bit	1.003	C, W, -, (R) ¹
Description: 1-bit object for disabling direct operation in the enlarged sun protection mode (direct operation = Move / Step / Position / Scene / Central). The polarity can be parameterized.					

¹ Each communication object can be read out. For reading, the R-flag must be set.

² The object designations are independent of the selected channel definition. In 2-channel operation, outputs 1&2 and 3&4 are combined into channel pairs (output 1/2 and output 3/4).

5

Description of software application

Channel-oriented objects:

Object	Function	Name	Type	DP-Type	Flag
Function: Sun protection function					
□ 18, 44, 70, 96	Sunshine / shading façade	Output 1 – 4 ²	1 Bit	1.002	C, W, –, (R) ¹
Description: 1-bit object for activation or deactivation of sun shading in the simple or enlarged sun protection mode (sun / no sun). The polarity can be parameterized.					
Function: Sun protection function					
□ 19, 45, 71, 97	Sunsh./shading position ³	Output 1 – 4 ²	1 Byte	5.001	C, W, –, (R) ¹
Description: 1-byte object for presetting a variable position value (0 ... 255) for the height of the blind/shutter curtain or the venting louver position when the sun protection is active.					
Function: Sun protection function					
□ 20, 46, 72, 98	Sunsh./shading slat position	Output 1 – 4 ²	1 Byte	5.001	C, W, –, (R) ¹
Description: 1-byte object for presetting a variable slat position value (0 ... 255) when the sun protection is active.					
Function: Sun protection function					
□ 21, 47, 73, 99	Sunshine slat position offset	Output 1 – 4 ²	1 Byte	6.001	C, W, –, (R) ¹
Description: 1-byte object for presetting a slat position angle (–100 % ... +100 % / smaller or larger position angles are treated as + or –100 %) for 'manual' readjustment of the slat position during active sun protection.					
Function: Sun protection function – automatic heating/cooling					
□ 22, 48, 74, 100	Heating/cooling presence	Output 1 – 4 ²	1 Bit	1.018	C, W, –, (R) ¹
Description: 1-bit object for activation of the presence mode during automatic heating/cooling The polarity can be parameterized. This object is generally linked with presence detectors.					
Function: Sun protection function – automatic heating/cooling					
□ 23, 49, 75, 101	Heating/cooling change-over:	Output 1 – 4 ²	1 Bit	1.100	C, W, –, (R) ¹
Description: 1-bit object for changing over between heating and cooling operation during automatic heating/cooling The polarity can be parameterized. This object is generally linked with room temperature controllers (object "heating/cooling change-over").					
Function: Position feedback					
□ 24, 50, 76, 102	Position feedback ³	Output 1 – 4 ²	1 Byte	5.001	C, –, T, R ^{1,4}
Description: 1-byte object for position feedback of the blind/shutter curtain height or louver position (0 ... 255)					
Function: Position feedback					
□ 25, 51, 77, 103	Slat position feedback	Output 1 – 4 ²	1 Byte	5.001	C, –, T, R ¹
Description: 1-byte object for position feedback of the slat position (0 ... 255).					
Function: Position feedback					
□ 26, 52, 78, 104	Invalid position feedback	Output 1 – 4 ²	1 Bit	1.002	C, –, T, R ¹
Description: 1-bit object for reporting back an invalid position of the blind/shutter curtain height or louver position ("0" = position valid / "1" = position invalid).					
Function: Travel movement feedback					
□ 27, 53, 79, 105	Travel movement feedback	Output 1 – 4 ²	1 Bit	1.002	C, –, T, R ^{1,4}
Description: 1-bit object for active travel movement feedback (output active – up or down). ("0" = no travel movement / "1" = travel movement)					

¹ Each communication object can be read out. For reading, the R-flag must be set.² The object designations are independent of the selected channel definition. In 2-channel operation, outputs 1&2 and 3&4 are combined into channel pairs (output 1/2 and output 3/4).³ The object designation varies with the type of curtain (blind, shutter / awning, venting louver).⁴ Depending on parameterization, feedback objects are either actively transmitting (T-flag set) or passively readable (R-flag set).

5 Description of software application

Channel-oriented objects:

Object	Function	Name	Type	DP-Type	Flag
Function: Position preset					
□↓ 28, 54, 80, 106	Position 3	Output 1 – 4 ²	1 Byte	5.001	C, W, – (R) ¹
Description: 1-byte object for presetting a position value (0...255) for the height of the blind/shutter curtain or the venting louver position in direct operation.					
Function: Position preset					
□↓ 29, 55, 81, 107	Slat position	Output 1 – 4 ²	1 Byte	5.001	C, W, – (R) ¹
Description: 1-byte object for presetting a slat position value (0 ... 255) in direct operation.					

¹ Each communication object can be read out. For reading, the R-flag must be set.

² The object designations are independent of the selected channel definition. In 2-channel operation, outputs 1&2 and 3&4 are combined into channel pairs (output 1/2 and output 3/4).

Scope of functions

General:

- 4-channel operation for direct connection of four 230 V AC drive motors. As an alternative, the shutter/blind actuator can be configured for 2-channel operation with direct control of two 12 ... 48 V DC drives. Mixed operation of 230 V AC and 12 ... 48 V DC motors is not possible.
- Behaviour in case of bus voltage failure and bus voltage return as well as after ETS programming presettable for each output.
- Central control of all shutter outputs via 1-bit long-time operation telegram possible.
- Active feedback telegrams can be globally delayed after bus voltage return.
- Manual control of outputs independent of the bus (for instance, site operation) with LED state indicators.

Channel-oriented functions:

- Each output offers the full scope of functions without any restrictions. All channel-oriented functions can be parameterized separately for each output. This feature permits independent and multi-functional control of the shutter outputs.
- Mode of operation parameterizable: control of blinds with slats, shutters or venting louvers.
- Separately parameterizable blind/shutter movement times with time extension for moves into the upper end position.
- Optionally with automatic end position detection (automatic determination of the blind/shutter movement time) for 230 V drive motors with mechanical limit switches.
- For blinds with slats, a slat-moving time can be independently parameterized
- Direction change-over time and the times for short-time and long-time operation (step, move) presettable.
- Blind/shutter or slat position feedback telegram (only with bus control). In addition, an invalid blind/shutter position or an invalid travel movement can be reported back. Active (transmitting after changes) or passive (object readout) feedback functions.
- Assigning of outputs to up to 5 different safety functions (3 wind alarms, 1 rain alarm, 1 frost alarm) optionally with cyclical monitoring. The safety functions (objects, cycle times, priority) are programmed device-oriented and in common for all outputs. The assignment of individual outputs to the safety functions and the safety measures can be parameterized for each channel.
- An extensive sun protection function with fixed and variable blind/shutter or slat positions at the beginning and at the end of the function can be activated separately for each output. Dynamic slat offset for slatted blinds included. Also with enlarged sun protection feature for integration into sophisticated shading control programs. Optionally also with automatic heating/cooling and presence detection function.
- Forced-position function can be implemented for each shutter output.
- Integration into light-scenes possible: up to 8 internal scenes adjustable per output.
- In the shutter/awning mode of operation, the fabric-stretching function can be activated. The fabric-stretching function permits stretching the fabric of an awning tight after lowering. The fabric-stretching function can also be used with shutters to re-open the slits of the shutter curtain after a downward movement into the lower end position.

5 Description of software application

Sun protection function – General information

Each output of the shutter actuator can be separately configured for the execution of a sun protection function. Sun protection is generally realized with blinds, shutters or awnings and offers an intelligent method of shading rooms, terraces or balconies during sunshine depending on the altitude of the sun in the sky and on the intensity of the sunlight (Fig. D).

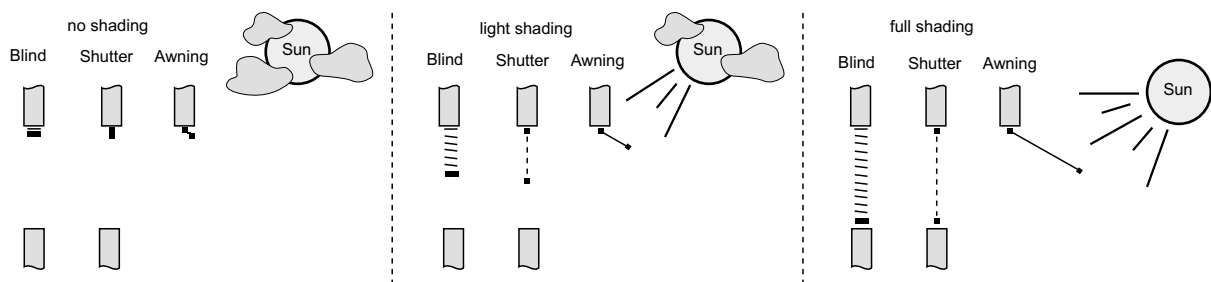

Fig. D: Sun protection principles (example)

The sun protection functions of the shutter actuator can be adapted to many different applications.

In simple sun protection applications as, for instance, in case of direction-dependent measurement of the sun's intensity by means of a brightness sensor, the curtains controlled can be closed partly or completely to prevent being disturbed by direct sunlight. In these applications, the sun protection function merely evaluates the 1-bit sun signal from the brightness or a similar sensor (e.g. weather station with limit value monitoring) and makes a drive open or close the controlled curtains by moving them into fixed parameterized positions or into variable positions preset via the bus.

In extended (enlarged) sun protection applications – for instance where the degree of shading is controlled by weather stations evaluating additionally the sun angle as a function of astro coordinates and presetting the blind and also the slat positions dynamically – the sun protection function can be supplemented by an automatic control system.

In such applications, the sun protection function evaluates additional bus communication objects allowing to enable or to disable the automatic control while the shutter actuator is in operation. This results in a large number of combination variants with intelligent blind/shutter control systems.

Already simple sun protection applications are sufficient to permit a fixed or variable re-adjustment of the positions of blind slats for adapting the curtain to individual shading requirements. For such purpose, it is possible to preset a static slat offset in the ETS parameters, for instance, for adapting the reflection of sunlight depending on the building situation, or additionally, a dynamical slat offset via a bus communication object, for instance, for manual re-adjustment of the slat opening by persons in the room or otherwise by a central building services control system. In all cases, the priority between an incoming sunshine or automatic telegram and the direct operation of an output (short-time, long-time telegram, scenes, positioning, central) is also presettable in the ETS. This way, a sun protection position can, for instance, be influenced by a 'manual' operation of a touch sensor in the room and the sun protection function be interrupted. Alternatively, the protection function cannot be interrupted by a direct operation. I.e. the output is interlocked.

A sun protection function can be overridden by a safety function, a forced position or also by a manual control locally on the device itself as these functions of the actuator invariably have a higher priority. At the end of one of the mentioned functions with a higher priority, the same reaction as the one at the beginning of sun protection will be re-executed, if the sun protection function is still active at this time.

Automatic heating/cooling function

When automatic heating/cooling is active, a presence signal – e.g. from a KNX presence monitor or a detector – is evaluated in addition to the signals of the enlarged sun protection function. The automatic sun protection function will then only be activated by the shutter actuator when persons are in the room. Depending on the sunshine signal, the room is then protected against sunshine or not as described in the preceding chapters.

Without receiving a presence signal the shutter actuator evaluates in addition a heating/cooling signal derived, for instance, from a room temperature controller or from an outside thermostat. In this case, the shading function can be used to support the heating or cooling function in a room. As no persons are present in the room, intensive sunlight can be used, for instance, to heat up the room by opening the slats or by raising the curtain. Similarly, the room can also be shaded against sunlight during the absence of persons, if additional heating up of the room is not desired.

Actuators

Shutters

1

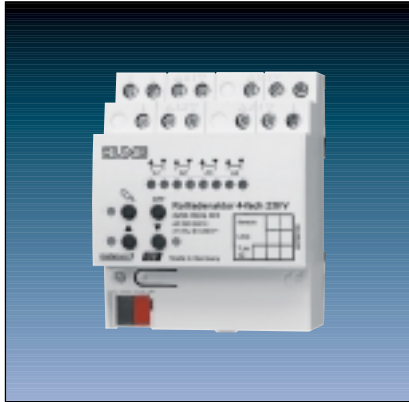

2

	Ref.-No.
KNX shutter actuator,	
4-gang 230 V AC	2204 REG HR
ETS-product family:	Shutter
Product type:	Shutter 4-gang
Series embodiment (SE)-device (4 units)	

3

Depending on KNX telegrams received, the shutter actuator switches up to four independent output channels, one for each motor (4-channel operation). The number of output channels can also be reduced to two so that up to two shutter motors can be controlled per channel (2 x 2-channel operation).

The shutter actuator is equipped with a manual control feature permitting bus-independent operation of the individual outputs in a permanent or temporary mode.

On reception of a storm warning, the actuator can, for instance, move the shutter into a predefined safety position and lock them there. Each output can be independently parameterized for individual moving times.

The 4 manual switches on the front panel of the device permit switching the relays on and off by hand in parallel with the KNX even without bus voltage or in a non-programmed state. This feature permits fast checking of connected motors for proper functioning.

The shutter actuator has its own mains supply independent of the connected drives. For actuation of the outputs, the mains supply must always be on.

Connection diagram:

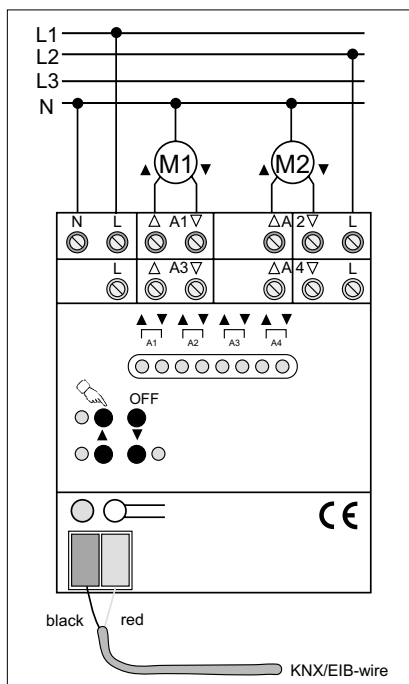

1 programming button
1 programming LED (red)

Manual controls:

1 " " key for manual control mode activation (select key)
1 "OFF" key (ALL stop)
1 "▲" key for manual UP movement
1 "▼" key for manual DOWN movement

Status indicators:

8 LEDs (red) to indicate the movement direction of the individual outputs or of the manually selected output
1 LED (red) to indicate the "permanent manual mode"
1 LED (red) to indicate the "UP" movement of the manually selected output
1 LED (red) to indicate the "DOWN" movement of the manually selected output

4

Technical data

Supply

Voltage:	21 – 32 V DC (SELV)
Power consumption:	max. 150 mW
Connection:	KNX connection and branching terminal

External supply

Voltage:	110 V (-10 %) – 240 V (+10 %) AC; 50/60 Hz (no DC)
Total power dissipation:	min. 0.3 W up to max. 1.8 W (no load connected)
Connection:	screw terminals: 0.5 – 4 mm ² single wire and stranded without ferrule 0.5 – 2.5 mm ² stranded wire with ferrule

Response to voltage failure

Bus voltage only:	parameter-dependent
Mains voltage only:	All outputs switch off (stop); manual control not possible.
Bus and mains voltage:	All outputs switch off (stop); manual control not possible.

Response on reactivation

Bus voltage only:	Mains voltage not available: Outputs are off (stop); bus communication is possible, i.e. safety functions can be activated Mains voltage available: parameter-dependent Bus voltage not available: parameter-dependent, manual control is possible. Bus voltage available: All outputs switch off or remain off (stop) until a new bus telegram is received and until the switching state changes. Exception: The actuator automatically reactivates the safety function(s) for the outputs assigned if the safety objects were activated before or during the mains failure. The parameterized "response at the beginning of the safety function" is repeated. A safety function activated before and deactivated during the mains failure does not launch a new movement on return of the mains voltage. If a safety function was at first activated and then deactivated again during the mains failure, the actuator launches a new movement for the outputs assigned after return of the mains as parameterized for "at the end of a safety function". In any case, the outputs assigned are re-enabled after safety deactivation. Manual control is possible.
Mains voltage only:	parameter-dependent, manual control is possible. Bus voltage available: All outputs switch off or remain off (stop) until a new bus telegram is received and until the switching state changes. Exception: The actuator automatically reactivates the safety function(s) for the outputs assigned if the safety objects were activated before or during the mains failure. The parameterized "response at the beginning of the safety function" is repeated. A safety function activated before and deactivated during the mains failure does not launch a new movement on return of the mains voltage. If a safety function was at first activated and then deactivated again during the mains failure, the actuator launches a new movement for the outputs assigned after return of the mains as parameterized for "at the end of a safety function". In any case, the outputs assigned are re-enabled after safety deactivation. Manual control is possible.
Bus and mains voltage:	parameter-dependent

Output

Type of switching contact:	1 make contact and 1 change-over contact per output, monostable (movement directions mechanically interlocked.)
Number of outputs:	4
Switching voltage:	110 V – 240 V AC +/-10 %, 50/60Hz (no DC)
Max. switching current:	6 A at 230 V AC: non inductive or low-inductance loads (e.g. condenser-type motors)
Connection:	Screw terminals: 0.5 – 4 mm ² single wire and stranded without ferrule 0.5 – 2.5 mm ² stranded wire with ferrule

5 Description of software application

Objects

Number of addresses (max):	32
Number of assignments (max):	32
Communication objects:	10

Object	Name	Function	Type	Flag
Mode of operation "4-channel operation"				
<input type="checkbox"/> 0	Output 1	Short operation (STEP)	1 Bit	C, W, (R*)
<input type="checkbox"/> 1	Output 2	Short operation (STEP)	1 Bit	C, W, (R*)
<input type="checkbox"/> 2	Output 3	Short operation (STEP)	1 Bit	C, W, (R*)
<input type="checkbox"/> 3	Output 4	Short operation (STEP)	1 Bit	C, W, (R*)
<input type="checkbox"/> 4	Output 1	Long operation (MOVE)	1 Bit	C, W, (R*)
<input type="checkbox"/> 5	Output 2	Long operation (MOVE)	1 Bit	C, W, (R*)
<input type="checkbox"/> 6	Output 3	Long operation (MOVE)	1 Bit	C, W, (R*)
<input type="checkbox"/> 7	Output 4	Long operation (MOVE)	1 Bit	C, W, (R*)
Mode of operation "2 x 2-channel operation"				
<input type="checkbox"/> 0	Output 1/3	Short operation (STEP)	1 Bit	C, W, (R*)
<input type="checkbox"/> 1	Output 2/4	Short operation (STEP)	1 Bit	C, W, (R*)
<input type="checkbox"/> 4	Output 1/3	Long operation (MOVE)	1 Bit	C, W, (R*)
<input type="checkbox"/> 5	Output 2/4	Long operation (MOVE)	1 Bit	C, W, (R*)
<input type="checkbox"/> 16	Safety 1	Safety	1 Bit	C, W, (R*)
<input type="checkbox"/> 17	Safety 2	Safety	1 Bit	C, W, (R*)

* : For objects marked (R), the current object status can be read out (set "R" flag).

Description of objects (dynamic object structure):

<input type="checkbox"/> 0 – 3	Short operation (STEP):	1-bit object for short operation (STEP) of a shutter
<input type="checkbox"/> 4 – 7	Long operation (MOVE):	1-bit object for long operation (MOVE) of a shutter
<input type="checkbox"/> 16 – 17	Safety:	1-bit object for reception of an alarm resp. safety message (polarity can be parameterized)

Scope of functions

- Mode of operation: 4-channel operation or 2 x 2-channel adjustable:
 - In 4-channel operation, 4 independent output channels, each for one shutter motor or for similar systems.
 - In 2 x 2-channel operation, reduction of output channels, so that two output terminals can be used in common for two motors per output channel.
- Short operation (STEP) or long operation (MOVE) presetable independently for each output channel (long operation (MOVE) also infinitely).
- Switch-over delay at change of movement direction independently presetable for each output.
- Automatic moving time extension (3 %) for the adaptation of different moving times to upper limit stop (dependent on drive unit). This is useful since shutters are slower during UP movements.
- Two safety functions separately assignable to shutter channels and common cyclical monitoring: Movement into a parameterized limit position on activation and deactivation of the safety function(s). The polarity of the safety objects is adjustable.
- Response after failure and return of bus voltage adjustable.
- Manual control of the output channels is possible even without bus voltage. The manual control mode can be inhibited.

5 Safety function

The shutter actuator has two safety functions with separate assignment to the shutter. Safety functions can be activated or deactivated by separate objects. The priority of the objects can be parameterized.

Scope of functions

Safety reaction

The reaction of the assigned output channels at the beginning and at the end of a safety function can be preset.

Response at the beginning of a safety function

The actuator moves the shutters alternatively into one of the limit stop position, if the response at safety is parameterized for "Moving up" or "Moving down". With these settings, the shutters are locked up in the limit position after the end of the safety movement. If the response at safety at the beginning of the safety function is parameterized for "No reaction", no movement is started and the output channels are locked in the actual position.

With respect to all other bus-controllable functions of the actuator, the safety function has the highest priority. This means that all functions in progress for the outputs (e.g. short or long operations) will be aborted and the safety reaction is executed. The safety function can be interrupted only by manual control on the device itself.

Response at the end of a safety function

At the end of a safety function, the actuator immediately re-enables the output channels concerned when the setting is "Moving up" or "Moving down" and approaches the corresponding limit stop positions. If the response at the end of a safety function is parameterized for "No reaction", the corresponding outputs are enabled without starting a new movement. If enabling by "No reaction" occurs during a safety movement still in progress, the outputs are enabled without interrupting the movement.

Safety assignment

Each output channel can be assigned separately to safety functions 1 or 2 or alternatively to both safety functions. If a channel is intended to respond to both functions, the safety objects resp. the functions are combined by a logic OR. This means that the corresponding output channel goes into the safety lock state as soon as one of the objects is active. In this case, the channel will be re-enabled only if both objects are deactivated. Only then can a position follow-up be performed at the end of the safety lock of a channel assigned to both functions! If the setting is "No assignment", the safety function for this output channel is deactivated.

Actuators

Dimming, 1-gang, Flush mounted

1

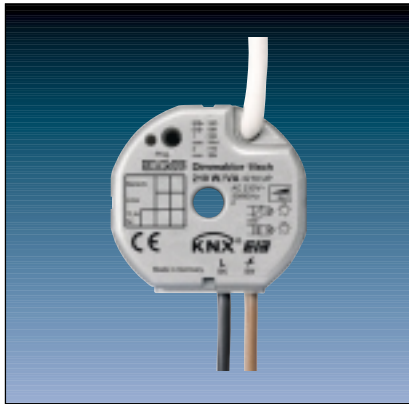

2

	Ref.-No.
KNX dimming actuator, flush mounted	
1-gang	3210 UP
ETS-product family:	Illumination
Product type:	Dimmer

3

The universal dimming actuator receives telegrams for switching or dimming purposes. It can work with the principle of trailing or leading edge control. That means either low voltage halogen lamps with TRONIC transformer or conventional (inductive) transformer can be controlled.

The device is equipped with two extension inputs which – depending on parameterization – can act directly on the switching output (local control with input 1) or alternatively as binary inputs on the KNX. The connected potential-free switch or push-button contacts are sensed against a common reference potential at the dimming actuator. As a binary input, the device can transmit telegrams for switching or dimming, for shutter/ blind control or for value transmitter applications (dimming value transmitter, light-scene extension).

Connecting 230 V signals or other external voltages to the extension inputs is not permitted. The dimming actuator is supplied from the KNX and needs therefore no additional external power supply.

4

Technical data

KNX supply

Cable type:	YY 6 x 6.0 mm; red: bus (+) / black: bus (-)
Voltage:	21 – 32 V DC SELV
Power consumption:	typically 150 mW
Connection:	approx. 33 cm ready-made; connecting terminal (0.6 – 0.8 mm)

Input

Number:	2 (depending on parameterization either as extension inputs for push-button local control of the actuator or as independent binary inputs acting on the bus)
---------	--

Cable type:

YY 6 x 0.6 mm	
green:	extension input 1
white:	reference potential (com)
yellow:	extension input 2
brown:	reference potential (com)

Cable length:

approx. 33 cm ready-made, extendible to 5 m max.

Scanning voltage:

approx. – 19 V DC referred to “com”; continuous signal

Loop resistance:

max. 2 kOhm for safe “1” signal detection (rising edge)

4 Technical data

Output											
Number:	1										
Cable type:	2 x H05 V-K 2.5 mm ² with ferrules										
Cable length:	approx. 20 cm ready-made										
Switch type:	Power MOS-FET, leading or trailing edge										
Nominal voltage:	230 V AC; 50/60 Hz										
Nominal current:	0,9 A										
Nominal load:	50 – 210 W/VA										
Dimmable loads:	<table> <tr> <td>Incandescent lamps</td> <td>trailing edge</td> </tr> <tr> <td>HV halogen lamps</td> <td>trailing edge</td> </tr> <tr> <td>LV halogen lamps</td> <td></td> </tr> <tr> <td>inductive transformers</td> <td>leading edge</td> </tr> <tr> <td>electronic transformers</td> <td>trailing edge</td> </tr> </table>	Incandescent lamps	trailing edge	HV halogen lamps	trailing edge	LV halogen lamps		inductive transformers	leading edge	electronic transformers	trailing edge
Incandescent lamps	trailing edge										
HV halogen lamps	trailing edge										
LV halogen lamps											
inductive transformers	leading edge										
electronic transformers	trailing edge										
Type of protection:	IP 20										
Safety class:	III										
Mark of approval:	KNX										
Ambient temperature:	-5°C ... +45°C										
Storage/transport temperature:	-25°C ... +70°C (storage above +45°C results in shorter lifetime)										
Mounting position:	any										
Minimum spacings:	none										
Type of fastening:	e.g. placing into deep flush-mounting box (Ø 60 mm x 60 mm)										

Note:

- Never connect the mains voltage (230 V) or other external voltages to the extension inputs. Connecting an external voltage endangers the electrical safety of the entire KNX system (SELV/no electrical insulation)
- Make sure during the installation that there is always sufficient insulation between the mains voltage and the bus or the extensions. A minimum spacing of 4 mm must be ensured between the bus/extension wires and the mains wires.
- Non-used wires of the 6-wire connecting cable must be insulated with respect to one another and with respect to external voltages.
- To avoid EMC disturbances, the lines to the inputs should not be laid parallel to lines and cables carrying mains voltage.

5 Description of software application

Objects

Number of addresses:	26
Number of assignments:	27
Communication objects:	19

Objects for the binary inputs (extension inputs), if acting on the bus:

Object	Name	Function	Type	Flag
Function: "Switching" (for all 2 inputs ³)				
2 – 3	Input 1 – Input 2	Switching object X.1 (X = 1 to 2)	1 Bit	C, W, T, (R) ¹
10 – 11	Input 1 – Input 2	Switching object X.2 (X = 1 to 2)	1 Bit	C, W, T, (R) ¹
Function: "Dimming" (for all 2 inputs ³)				
2 – 3	Input 1 – Input 2	Switching	1 Bit	C, W, T, (R) ¹
10 – 11	Input 1 – Input 2	Dimming	4 Bit	C, T, (R) ¹
Function: "Shutter/blind" (for all 2 inputs ³)				
2 – 3	Input 1 – Input 2	Short operation	1 Bit	C, T, (R) ¹
10 – 11	Input 1 – Input 2	Long operation	1 Bit	C, T, (R) ¹
Function: "Value transmitter" (Function: Dimming value transmitter for all 2 inputs ²)				
2 – 3	Input 1 – Input 2	Value	1 Byte	C, T, (R) ¹
Function: "Value transmitter" (Function: Light-scene extension with/without storage function for all 2 inputs ²)				
2 – 3	Input 1 – Input 2	Light-scene extension	1 Byte	C, T, (R) ¹
Function: "Disable" (for all 2 inputs ³)				
2 – 3	Input 1 – Input 2	Disabling	1 Bit	C, W, (R) ¹

¹ : Objects marked (R) permit read-out of the object status (set R flag).

² : The "No function", "Switching", "Dimming", "Shutter/blind" and "Value transmitter" functions can be selected per input. The names of the communication objects and the object table (dynamic object structure) will change accordingly.

³ : A disable function is not available if the inputs are parameterised for "No function".

5 Objects for the output:

Object	Name	Function	Type	Flag
0	Output	Switching	1 Bit	C, W, (R) ¹
3	Output	Dimming	4 Bit	C, W, (R) ¹
4	Output	Brightness value	1 Byte	C, W, T ² , (R) ¹
5	Output	ACK switching	1 Bit	C, W, (R) ¹
6	Output	ACK brightness value	1 Byte	C, W, (R) ¹
7	Output	Inhibit	1 Bit	C, W, (R) ¹
11	Output	Light scene extension	1 Byte	C, W, (R) ¹
12	Output	Message short circuit	1 Bit	C, W, (R) ¹
13	Output	Message load failure	1 Bit	C, W, (R) ¹

¹: Objects marked (R): permit read-out of the object status (set R flag).

²: Objects marked (T): the actual brightness value is transmitted automatically to the bus set (T) flag.

This function requires the following parameter setting: "Value acknowledge object available? = NO".

Description of software application

- Switching and dimming behaviour adjustable by parameters.
- Acknowledge for switching status by special acknowledge objects.
- Transmission of actual brightness value via the brightness value object (set T-flag!) or by the special acknowledge objects.
- Soft-ON, soft-OFF and delayed dimming adjustable by parameters.
- Dimming to or jumping to brightness vaule.
- Light scene operation possibility (up to eight different saved values can be recalled as a light scene) → no special light scene push-button necessary!
- Blocking operation by special object with parameterised brightness value at start and end of blocking.
- Additional objects for short circuit message or load failure message.
- Behaviour on bus voltage recovery adjustable.

Actuators

Dimming 1-gang

1



2

KNX universal dimming actuator	Ref.-No.
1-gang	3601 REG
ETS-product family:	Illumination
Product type:	Dimmer
Series embodiment (SE)-device (4 units)	

3

The universal dimming actuator receives telegrams for switching or dimming purposes. It can work with the principle of trailing or leading edge control. That means either low voltage halogen lamps with TRONIC transformer or conventional (inductive) transformer can be controlled. The max. capacity can be extended by using JUNG power amplifiers (see main catalogue). Depending on the parameter it is possible to activate various additional functions.

4

Technical data

Supply	
Voltage:	24 V DC (+6 V / -4 V)
Power consumption:	150 mW
Connection:	KNX connection block
Output	
Number:	1
Performance:	Power MOS-FET, trailing edge or leading edge
Rated voltage:	230 V AC \pm 10 %, 50/60 Hz
Rated current:	2.2 A
Min. Capacity:	50 W
Capacity:	50 to 500 W ohmic load 50 to 500 W high voltage halogen load 50 to 500 W LV halogen with conventional transformer 50 to 525 W LV halogen with TRONIC transformer
Connection:	clamp bar
Protection:	IP 20
Behaviour at voltage drop	
only bus voltage:	dimming actuator switches off
only mains:	dimming actuator switches off
bus and mains:	dimming actuator switches off
Behaviour at voltage recovery	
only bus voltage:	dependent on parameters
only mains:	device controls brightness according to object value
bus and mains:	dependent on parameters
Operation temperature:	-5°C ... +45°C
Storage/transport temperature:	-25°C ... +75°C
Mounting:	on DIN rail 35 x 7.5

5 Wiring diagrams:

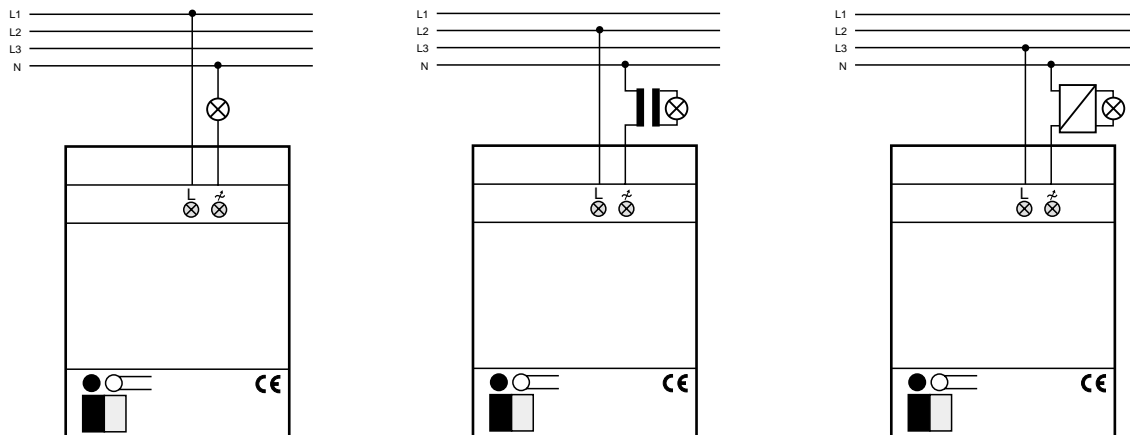

Notes:

- The device is equipped with a short circuit and over temperature protection.
 Trailing edge control: The channel switches off after 7 s.
 Leading edge control: The channel switches off after 100 ms.
- After over temperature detection the channel is switched on again to the given brightness value after it is cooled down.
- After the first installation or after mains recovery the device detects the load and will be adjusted (between 1 and 10 s) to the corresponding load (trailing or leading edge control).
- Mixed loads, i.e. TRONIC and inductive transformer are NOT allowed !
- Within a mixed load with inductive transformers and ohmic load the ohmic part must be below 50 % !

Description of software application:

- Switching and dimming behaviour adjustable by parameters.
- Acknowledge for switching status by special acknowledge objects.
- Transmission of actual brightness value via the brightness value object (set T-flag!) or by the special acknowledge objects.
- Soft-ON, soft-OFF and delayed dimming adjustable by parameters.
- Dimming to or jumping to brightness value.
- Light scene operation possibility (up to eight different saved values can be recalled as a light mood) no special light scene push-button necessary !
- Blocking operation by special object with parameterised brightness value at start and end of blocking.
- Additional objects for short circuit message or load failure message.
- Behaviour on bus voltage recovery adjustable

Objects

Number of addresses: 27
 Number of assignments: 27
 Communication objects: 18

Object	Name	Function	Type	Flag
0	Output	Sswitching	1 Bit	C, W, (R)
2	Output	Dimming	4 Bit	C, W ,(R)
4	Output	Brightness value	1 Byte	C, W, (R), (T)
6	Output	Acknowledge switching	1 Bit	C, T, (R)
8	Output	Acknowledge value	1 Byte	C, T, (R)
10	Output	Blocking	1 Bit	C, W, (R)
12	Output	Light mood extension input	1 Byte	C, W, (R)
14	Output	Message short circuit	1 Bit	C, T, (R)
16	Output	Load failure message	1 Byte	C, T ,(R)

Objects marked with (R): Object value can be read out (set R-flag!)

Objects marked with (T): The actual brightness value is transmitted automatically to the bus (set T-flag!).

This function requires the following parameter setting: "Value acknowledge object available ? = NO"

5

Notes to software application:

- Blocking function

The dimming actuator can be blocked via the bus while the actual brightness value is saved and kept constantly. A certain brightness value can be adjusted by parameters at start and end of blocking.

- Brightness value object

The actual brightness value is adjusted automatically in the brightness value object. By setting the R-flag the actual value can be read out.

By setting the T-flag the actual brightness value can be transmitted to the bus only with the following parameter setting: "Value acknowledge object available ? = NO"

- Acknowledge of switching status

When the switch status of the dimming actuator is changed from OFF to ON, or from ON to OFF, a corresponding switch telegram is transmitted to the bus via the acknowledge object. Also during a change from OFF to OFF or ON to ON the corresponding acknowledge telegram is transmitted.

During a soft-ON function the acknowledge is transmitted at the start of the dimming process, whereby with an activated soft-OFF function the corresponding acknowledge is transmitted at the end of the dimming process.

- Short circuit / load failure message

The dimming actuator is capable to transmit a 1 Bit telegram on the bus when a short circuit is detected. Simultaneously if selected by parameters the switching or the value status is transmitted, too.

Additionally, when a load failure is detected, i.e. a damaged bulb, the device transmits a 1 Bit load failure telegram on the bus.

Actuators

Dimming 2-gang

1



2	KNX universal dimming actuator	Ref.-No.
	2-gang	3602 REG
	ETS-product family:	Illumination
	Product type:	Dimmer
	Series embodiment (SE)-device (4 units)	

3 The universal dimming actuator receives telegrams for switching or dimming purposes. It can work with the principle of trailing or leading edge control. That means either low voltage halogen lamps with TRONIC transformer or conventional (inductive) transformer can be controlled. The max. capacity can be extended by using power amplifiers (see main catalogue). Depending on the parameter it is possible to activate various additional functions.

4 Technical data

Supply	
Voltage:	24 V DC (+6 V / -4 V)
Power consumption:	150 mW
Connection:	KNX connection block
Output	
Number:	2
Performance:	Power MOS-FET, trailing edge or leading edge
Rated voltage:	230 V AC \pm 10 %, 50/60 Hz
Rated current:	2 x 1.1 A
Min. Capacity:	50 W per channel (if channel ist loaded)
Symmetrical capacity:	in total 50 to 600 W / VA 50 to 300 W ohmic load 50 to 300 W high voltage halogen load 50 to 300 W LV halogen with conventional transformer 50 to 300 W LV halogen with TRONIC transformer
Unsymmetrical capacity:	<ul style="list-style-type: none">• both channels loaded with max. 600 W/VA, with single load max. 400 W/VA per channel: i.e. channel 1: 350 W (ohmic load) channel 2: 250 VA (TRONIC load)• only one channel is used: max. 400 W/VA
Connection:	clamp bar
Protection:	IP 20

4 Technical data

Behaviour at voltage drop

only bus voltage:

only mains:

bus and mains:

Behaviour at voltage recovery

only bus voltage:

only mains:

bus and mains:

Operation temperature:

Storage/transport temperature:

Mounting:

dimming actuator switches off

dimming actuator switches off

dimming actuator switches off

dependent on parameters

device controls brightness according to object value

dependent on parameters

-5°C ... +45°C

-25°C ... +75°C

on DIN rail 35 x 7.5

5 Wiring diagrams:

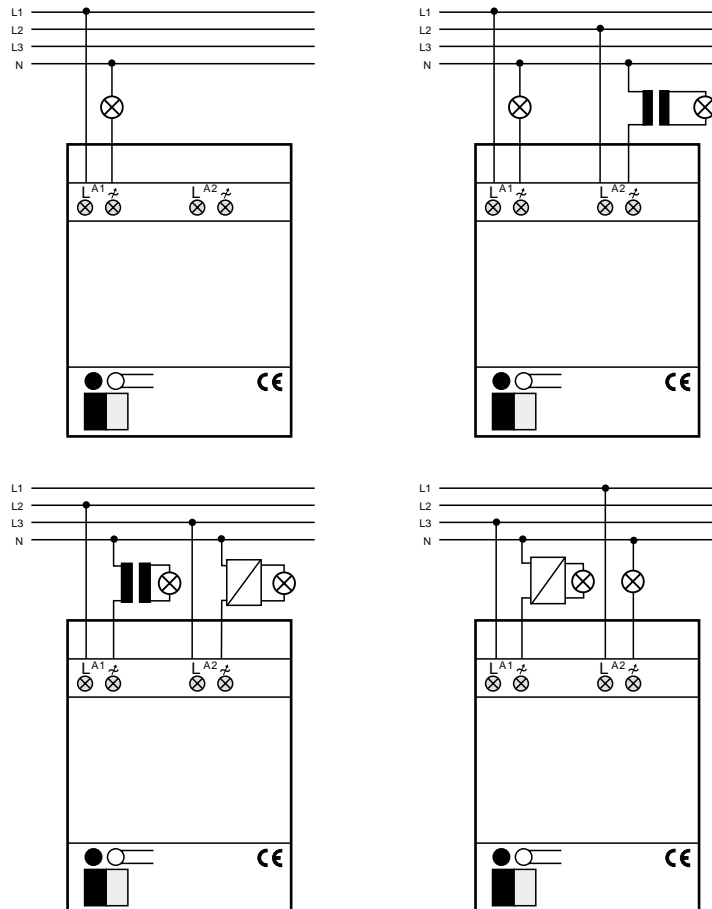

Notes:

- Different lines can be connected to the device.
- Each channel is equipped with a short circuit and over temperature protection.
Trailing edge control: The channel switches off after 7 s.
Leading edge control: The channel switches off after 100 ms.
- After over temperature detection the channel is switched on again to the given brightness value after it is cooled down.
- After the first installation or after mains recovery the device detects the load and will be adjusted (between 1 and 10s) to the corresponding load (trailing or leading edge control).
- Mixed loads, i.e. TRONIC and inductive transformer are allowed between the two channels, but NOT within one channel !
- Within a mixed load with inductive transformers and ohmic load the ohmic part must be below 50 % !

5 Description of software application:

- Switching and dimming behaviour adjustable by parameters.
- Acknowledge for switching status by special acknowledge objects.
- Transmission of actual brightness value via the brightness value object (set T-flag!) which is recommended or by the special acknowledge objects.
- Soft-ON, soft-OFF and delayed dimming adjustable by parameters.
- Dimming to or jumping to brightness value.
- Light scene operation possibility (up to eight different saved values can be recalled as a light scene) → no special light scene push-button necessary !
- Blocking operation by special object with parameterised brightness value at start and end of blocking.
- Additional objects for short circuit message or load failure message.
- Behaviour on bus voltage recovery adjustable.

Objects

Number of addresses (dynamic):	27
Number of assignments (dynamic):	27
Communication objects:	18

Object	Name	Function	Type	Flag
0	Output 1	Switching	1 Bit	C, W, (R)
1	Output 2	Switching	1 Bit	C, W, (R)
2	Output 1	Dimming	4 Bit	C, W, (R)
3	Output 2	Dimming	4 Bit	C, W, (R)
4	Output 1	Brightness value	1 Byte	C, W, (R), (T)
5	Output 2	Brightness value	1 Byte	C, W, (R), (T)
6	Output 1	Acknowledge switching	1 Bit	C, T, (R)
7	Output 2	Acknowledge switching	1 Bit	C, T, (R)
8	Output 1	Acknowledge value	1 Byte	C, T, (R)
9	Output 2	Acknowledge value	1 Byte	C, T, (R)
10	Output 1	Blocking	1 Bit	C, W, (R)
11	Output 2	Blocking	1 Bit	C, W, (R)
12	Output 1	Light scene extension input	1 Byte	C, W, (R)
13	Output 2	Light scene extension input	1 Byte	C, W, (R)
14	Output 1	Message short circuit	1 Bit	C, T, (R)
15	Output 2	Message short circuit	1 Bit	C, T, (R)
16	Output 1	Load failure message	1 Byte	C, T, (R)
17	Output 2	Load failure message	1 Byte	C, T, (R)

Objects marked with (R): Object value can be read out (set R-flag!)

Objects marked with (T): The actual brightness value is transmitted automatically to the bus (set T-flag!).

This function requires the following parameter setting: "Value acknowledge object available ? = NO"

Notes to software application:

• Blocking function

Each channel of the dimming actuator can be blocked via the bus while the actual brightness value is saved and kept constantly. A certain brightness value can be adjusted by parameters at start and end of blocking.

• Brightness value object

The actual brightness value is adjusted automatically in the brightness value objects. By setting the R-flag the actual value can be read out.

By setting the T-flag the actual brightness value can be transmitted to the bus only with the following parameter setting: "Value acknowledge object available ? = NO"

• Acknowledge of switching status

When the switch status of the dimming actuator is changed from OFF to ON, or from ON to OFF, a corresponding switch telegram is transmitted to the bus via the acknowledge object. Also during a change from OFF to OFF or ON to ON the corresponding acknowledge telegram is transmitted.

During a soft-ON function the acknowledge is transmitted at the start of the dimming process, whereby with an activated soft-OFF function the corresponding acknowledge is transmitted at the end of the dimming process.

• Short circuit / load failure message

The dimming actuator is capable to transmit a 1 Bit telegram on the bus when a short circuit is detected. Simultaneously if selected by parameters the switching or the value status is transmitted, too.

Additionally, when a load failure is detected, i.e. a damaged bulb, the device transmits a 1 Bit load failure telegram on the bus.

1

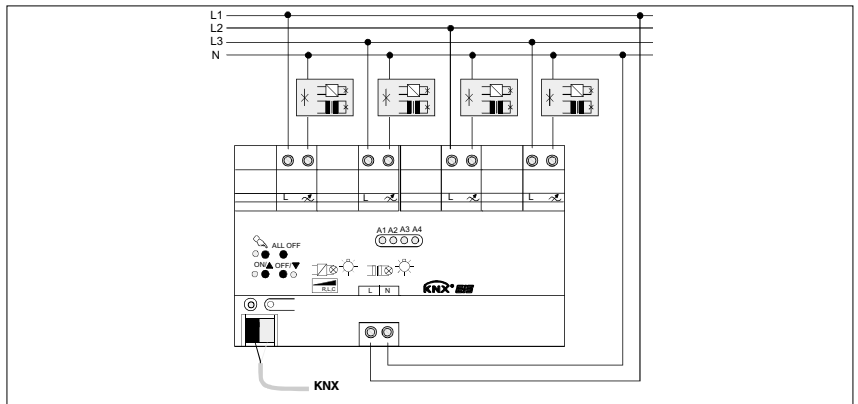

2

	Ref.-No.
KNX universal dimming actuator	
4-gang	3704 REG HE
ETS-product family:	Illumination
Product type:	Dimmer
Series embodiment (SE)-device (8 units)	

3

The universal dimming actuator receives telegrams for switching or dimming purposes. It can work with the principle of trailing or leading edge control. That means either low voltage halogen lamps with TRONIC transformer or conventional (inductive) transformer can be controlled. In a trailing edge application, the max. capacity can be extended by using power amplifiers (see main catalogue).

If the max. capacity of an output shall be extended by JUNG power amplifiers, the max. brightness (parameter) of the universal dimmer output must be set to maximum 90 %.

The universal dimming actuator offers a separate acknowledge of the single switching and dimming conditions of the connected loads.

Above that a short circuit or load failure message can be transmitted on the bus.

By means of its control elements (4 push-buttons) the dimming outputs can be operated also without bus connection or programming.

It is recommended to use the ETS3.0d version.

Depending on the parameter it is possible to activate various additional functions.

4

Technical data

KNX Supply

Voltage:	21 – 32 V DC (SELV)
Power consumption:	typically 150 mW
Connection:	Bus terminal (KNX Type 5.1)

External supply

Voltage:	190 ... 230 V AC +10 %/-15 %, 50/60 Hz
Power consumption:	approx. 1 W
Total power loss:	max. 8.5 W (at max. load)
Behavior at bus voltage drop:	Depending on parameter
Behavior at bus voltage recovery:	Depending on parameter

Outputs

Number:	4 (electronic, MosFETs)
Connection:	Screw terminals: 0.5 mm ² to 4 mm ² , solid or finely stranded conductor without wire end sleeve 0.5 mm ² to 2.5 mm ² , finely stranded conductor with wire end sleeve

Cable length per output: max. 100 m

4 Technical data

Capacity per output	
230 V-incandescent:	20 ... 210 W
230 V-HV-halogen:	20 ... 210 W
LV-halogen	
Conventional transformer:	20 ... 210 VA
Tronic-transformer:	20 ... 210 W
Mixed load, resistive-inductive:	20 ... 210 W/VA
Mixed load, resistive-capacitive:	20 ... 210 W
Mixed load, inductive-capacitive:	not allowed!
Motor load:	not allowed!
Type of protection:	IP 20
Safety class:	III
Mark of approval:	KNX/VDE
Ambient temperature:	-5°C ... +45°C
Storage/transport temperature:	-25°C ... +70°C (storage above +45°C results in shorter lifetime)
Mounting position:	any, recommended: output terminals on top
Minimum spacings:	none
Type of fastening:	on DIN rail 35 x 7.5

5 Description of software application

- Independent control of up to 4 dimming outputs.
- Independent hand-operation of the outputs.
- Central switching function for the collective control of all outputs.
- Acknowledge switching: active (at changing or cyclically) or passive (object can be read out).
- Preset of load-type and adjustment of the dimming principle for each output possible:
 - universal (with automatic teach-in),
 - electronic transformer (capacitive/trailing edge control),
 - conventional transformer (inductive/leading edge control).
- Adjustment of brightness limits (basic and max. brightness).
- Dimming behaviour (also fading) and dimming characteristic can be adjusted.
- Soft-On or Soft-Off-function.
- Separate report telegrams for each output regarding short-circuit/overload and load failure can be transmitted to the bus. The acknowledge of the connected load type is also possible.
- Inhibit or alternatively forced position function per output. During inhibit function the blinking of the connected load is possible.
- Time-functions (Switch On/Off delay, stair-case function – also with advance warning).
- Elapsed hour counter per output.
- Up to 8 light scenes per output.
- The reaction at bus-voltage drop and recovery and after an ETS-download can be adjusted per output.

Objects

Number of addresses:	254
Number of assignments:	255
Communication objects:	75

Superior channel objects:

Object	Name	Function	Type	DP-Type	Flag
<input type="checkbox"/> 0	Function: Hand-operation Inhibit	Hand-operation	1 Bit	1.003	C, W, -, (R) ¹
Description: 1 Bit object for inhibiting the push-buttons. Polarity adjustable.					
<input type="checkbox"/> 1	Function: Hand-operation Status	Hand-operation	1 Bit	1.002	C, -, T, (R) ¹
Description: 1 Bit object for the status of hand-operation. Object "0": hand-operation deactivated (bus-operation)- Object "1": hand-operation activated.					
<input type="checkbox"/> 2	Function: Central function Switching	Central	1 Bit	1.001	C, W, -, (R) ¹
Description: 1 Bit object for central switching of all assigned outputs. Polarity adjustable.					

¹ Each communication object can be read out. Set "R" flag.

5

Description of software application

Channel objects:

Object	Name	Function	Type	DP-Type	Flag
Function: Output switching					
□ 3, 21, 39, 57	Switching	Output 1 ... 4	1 Bit	1.001	C, W, -, (R) ¹
Description: 1 Bit object for switching On/Off ("1" = On/"0" = Off).					
Function: Relative dimming					
□ 6, 24, 42, 60	Dimming	Output 1 ... 4	4 Bit	3.007	C, W, -, (R) ¹
Description: 4 Bit object for dimming of an output.					
Function: Absolute dimming					
□ 7, 25, 43, 61	Brightness value	Output 1 ... 4	1 Byte	5.001	C, W, -, (R) ¹
Description: 1 Byte object for an absolute value (brightness value 0 ... 255).					
Function: Acknowledge switching					
□ 8, 26, 44, 62	ACK switching	Output 1 ... 4	1 Bit	1.001	C, -, T, R ²
Description: 1 Bit object for ACK of the switching status ("1" = On/"0" = Off).					
Function: Acknowledge absolute switching					
□ 9, 27, 45, 63	ACK brightness value	Output 1 ... 4	1 Byte	5.001	C, -, T, R ^{1,2}
Description: 1 Byte object for ACK of an adjusted dimming value.					
Function: Stair-case function					
□ 4, 22, 40, 58	Stair-case function start/stop	Output 1 ... 4	1 Bit	1.010	C, W, -, (R) ¹
Description: 1 Bit object for activation or deactivation of the switch-on time of the stair-case function ("1" = On/"0" = Off).					
Function: Stair-case function					
□ 5, 23, 41, 59	Stair-case time factor	Output 1 ... 4	1 Byte	5.010	C, W, -, (R) ¹
Description: 1 Byte object for setting the time factor of the stair-case time (0 ... 255).					
Function: Inhibit					
□ 10, 28, 46, 64	Inhibit	Output 1 ... 4	1 Bit	1.003	C, W, -, (R) ¹
Description: 1 Bit object for inhibiting of an output. Polarity adjustable.					
Function: Forced position					
□ 11, 29, 47, 65	Forced position	Output 1 ... 4	2 Bit	2.001	C, W, -, (R) ¹
Description: 2 Bit object for the forced position of an output. Polarity given by the telegram.					
Function: Scenario					
□ 12, 30, 48, 66	Light scene extension	Output 1 ... 4	1 Byte	18.001	C, W, -, (R) ¹
Description: 1 Byte object for calling-up or storing scenarios.					
Function: Short-circuit and overload detection					
□ 14, 32, 50, 68	Report short-circuit/overload	Output 1 ... 4	1 Bit	1.005	C, -, T, (R) ¹
Description: 1 Bit object for reporting of short-circuit or overload of an output.					

¹ Each communication object can be read out. Set "R" flag.² Depending on the parameter, acknowledge objects are either active (T-Flag set) or passive, can be read out (set "R" flag).

Universal dimming actuator 4-gang REG

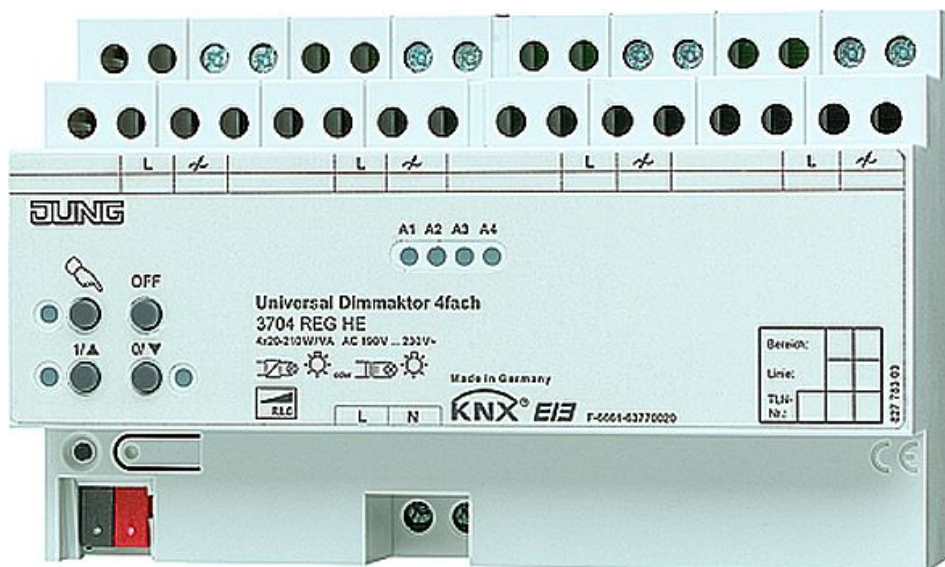

Date of issue: 25.01.2007
64770320.111

Table of Contents

1	<u>Product definition</u>	<u>3</u>
1.1	Product catalogue	3
1.2	Function	3
2	<u>Fitting, electrical connection and operation</u>	<u>4</u>
2.1	Safety instructions	4
2.2	Device components	5
2.3	Fitting and electrical connection	6
2.4	Commissioning	13
2.5	Operation	14
3	<u>Technical data</u>	<u>18</u>
4	<u>Software information</u>	<u>20</u>
4.1	Software specifications	20
4.2	Software "Dimming 301Ax1"	21
4.2.1	Scope of functions	21
4.2.2	Software information	22
4.2.3	Object table	23
4.2.4	Functional description	28
4.2.4.1	Device-independent functional description	28
4.2.4.2	Description of channel-independent functions	32
4.2.4.3	Description of channel-oriented functions	34
4.2.4.4	Delivery state	83
4.2.5	Parameters	84

1 Product definition

1.1 Product catalogue

Product name: Universal dimming actuator 4-gang REG
Use: Actuator
Design: REG (rail-mounted device)
Art. no.: 3704 REG HE

1.2 Function

The universal dimming actuator works on the phase cut-on or cut-off principle and permits switching and dimming of incandescent lamps, HV halogen lamps and LV halogen lamps with conventional and electronic transformers. The device auto-detects the load characteristics of the connected consumer separately for each output and selects the appropriate dimming principle. Alternatively, the dimming principle can also be fixed by means of the corresponding ETS parameters.

The universal dimming actuator permits independent feedback of the individual switching and brightness states of the connected loads by sending the respective telegrams to the KNX/EIB. Moreover, the device can report short-circuits and load failures back to the KNX/EIB separately for each output.

The controls (4 pushbuttons) on the front panel of the device permit switching the dimming outputs on and off by hand in parallel with the KNX / EIB even without bus voltage or in a non-programmed state. This feature permits fast checking of connected consumers for proper functioning.

For project design and start-up of this device it is recommended to use the ETS3.0d. The advantages with regard to downloading (shorter loading times) and parameter programming are available only if this ETS patch version or later versions are used.

The functionalities that can be selected independently for each dimming output include, for instance, separately programmable brightness ranges, enlarged feedback functions, a disabling or, alternatively, a forced-control function, separately presettable dimming behaviour, time delay and Staircase function with pre-warning and soft-dimming functions.

Each output can moreover be integrated into up to 8 scenes with different brightness values. Centralized switching of all outputs is also available. In addition, the brightness levels of the outputs in case of bus voltage failure or bus voltage return and after an ETS programming operation can be preset separately.

The universal dimming actuator has a power supply connection independent of the load outputs to supply the device electronics and the BCU with power. To permit switching of the outputs, the 230 V mains voltage must always be on. The BCU is additionally supplied from the bus voltage to permit programming with the ETS also in those cases where the mains voltage is not yet connected or switched off. The load outputs have separate phase conductor terminals to supply power to the connected load.

The device is designed for fitting on DIN rails in closed compact boxes or in power distributions in fixed installations in dry rooms.

2 Fitting, electrical connection and operation

2.1 Safety instructions

Electrical equipment must be installed and fitted only by qualified electricians. Observe the current accident prevention regulations.

Failure to observe any of the installation instructions may cause damage to the device and result in fire and other hazards.

The device is not suited for safe disconnection of the mains supply. Shutting off the device does not separate the load electrically from the supply.

Before working on the device or before replacing connected lamps, disconnect the supply voltage (by cutting out the circuit breaker) to avoid the risk of an electric shock.

Disconnect the mains supply also in case of changes to the connected load (e.g. when installing another lighting fixture or when replacing the lamp).

Make sure during the installation that there is always sufficient insulation between mains voltage and bus. A minimum spacing of 4 mm must be ensured between bus wires and mains conductors.

If inductive transformers are used, each transformer must be fuse-protected on the primary side in accordance with the manufacturer's instructions. Use only safety transformers in acc. with DIN EN 61558-2-6 (VDE 0570 Part 2-6)

For extending the load capacity of an output use only suitable power boosters. The selected boosters must be adapted to the dimmer and to the load. Further details are set out in the operating instructions of the corresponding power booster.

Do not open the device and do not operate it outside the scope of the technical specifications.

2.2 Device components

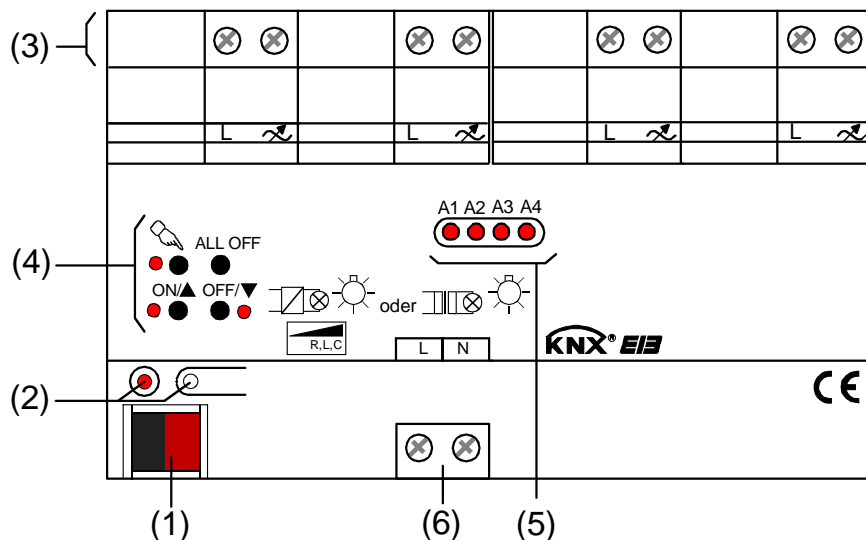

Dimensions:

width (W):
144 mm (8 MW)

height (H):
90 mm

depth (T):
70 mm

- (1): KNX/EIB bus connection
- (2): Programming button and programming LED (red). The programming LED flashes slowly when the safe-state mode is active.
- (3): Screw terminals (L, \sphericalangle) for connection of the load.
- (4): Keypad for manual operation with status LED
- (5): Status LED (red) of the outputs...
 - LED off: output is off,
 - LED on: output is on,
 - LED flashing slowly output operated manually
 - LED flashing fast: output disabled by manual operation
- (6): Screw terminals (L, N) for connection of the mains voltage supply (device supply).

2.3 Fitting and electrical connection

**DANGER!**

Electric shock in case of accidental contact with live parts. Electric shocks can be fatal. Before working on the device, cut out the mains supply and cover up live parts in the surroundings.

Fitting

- Fit the device by snapping it onto a mounting rail in acc. with DIN EN 60715. The screw terminals for connection of the load should be at the top.

i A KNX / EIB data rail is not required.

i Observe the temperature range (-5 °C ...+45 °C) and ensure sufficient cooling.

Connecting the power supply for the device electronics and the load

Observe the admissible load ratings (cf. 'Technical data').

Observe the Technical Operating Conditions of the power supply companies.

Do not exceed the permissible total load including transformer losses (cf. 'Technical data').

Operate inductive transformers with at least 85% of their rated load.

Mixed loads with inductive transformers at an output: Resistive load max. 50%.

Trouble-free operation is ensured only with TRONIC transformers from B-G-J or with inductive iron/copper transformers.

**CAUTION**

Risk of irreparable damage with mixed loads.

Do not connect capacitive loads (e.g. electronic transformers) and inductive loads (e.g. conventional transformers) in common to the same dimming output.

- Connect the mains voltage supply, the loads and the bus line as shown in fig. 1 (wiring example).

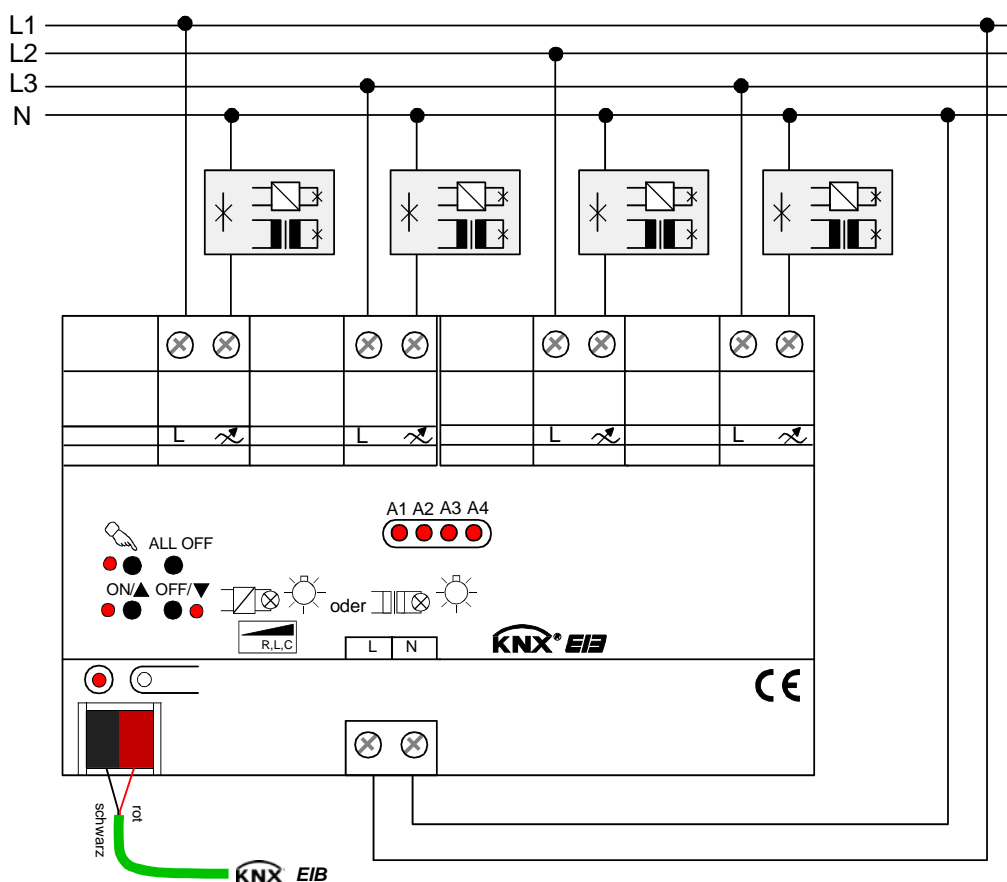

Fig. 1: Electrical connection of mains voltage supply and load

- ⓘ The load outputs and the mains voltage supply of the device (terminals "L") may be connected to different phase conductors (L1, L2, L3).
- ⓘ Telecontrol signals from the power supply companies may cause flickering of the connected lamps. This is not a defect of the device.
- ⓘ When the load capacity of an output is exhausted, the power rating of the actuator can be increased with Jung power boosters. The selected boosters must be adapted to the dimmer and to the load. The information contained in the operating instructions of the corresponding power booster must be observed.
If the load rating of an output is enhanced by universal power boost units, the maximum brightness (ETS parameter) is to be reduced to 90 % max.
- ⓘ If the auto-detection feature of the universal dimming actuator is not used, the dimming principle must be adapted to the connected load in the ETS (ETS parameter). In the state as delivered of the actuator, the automatic detection feature is activated for all outputs.

Changing the type of load connected

When one of the loads connected is changed after initial commissioning – e.g. when a ceiling light fixture with an incandescent lamp is replaced by a low-voltage lighting system with a conventional transformer – it may be the case that with the changing of the load the load type will change as well. If the load type is set to "universal" (ETS parameter), the dimming actuator will in this case try to readapt itself to the new load. For this purpose, the mains voltage supply of the dimming actuator must at first also be shut off.

It is absolutely important that the load type parameterized in the ETS matches the load connected. In case of doubt, the universal dimming principle (with automatic load detection) should be selected.



CAUTION

Risk of irreparable damage if the preselected dimming principle (ETS parameter) and the connected load are not compatible.

Before changing the load type, disconnect the mains supply of the dimming actuator and the load circuit concerned. Check the parameter settings and correct, if needed.

- Disconnect the load circuit from the mains supply (depending on ETS parameterization it may be the case that a load failure telegram will then be transmitted to the bus → see "Load failure detection").
- Disconnect the mains supply of the dimming actuator (terminals "L, N" beside the bus terminal).
- Connect the new load.
- Recommission the device (see chapter 2.4 "Commissioning").

i If the mains voltage supply of the loads and of the actuator are connected to different phase conductors, a multi-pole line circuit breaker is recommended for complete disconnection.

Installing / removing the protective cap

To protect the bus lines against hazardous voltages, especially in the area of the connecting terminals, a protective cap can be installed.

The bus must be connected with the bus line led out at the rear (bus terminal plugged into device).

- To install the cap: Slide the cap over the bus connecting terminal until it is heard to engage (cf. fig. 2.A).
- To remove the cap: Remove the cap by pressing the sides slightly and by pulling it out to the front (cf. fig. 2.B).

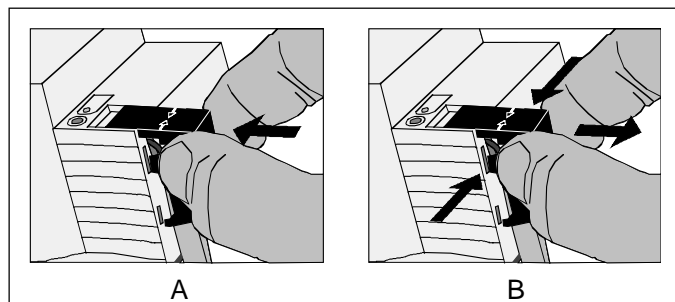

Fig. 2: Installing / removing the protective cap

Load failure detection

The universal dimming actuator can monitor the current circuits of its load outputs independently of one another. The actuator detects mains supply failures (> 15 s) of an output or a circuit interruption when the load is on or off. The load detection function must be separately enabled in the ETS (cf. chapter 4. "Software description").

A load failure caused by an interruption of the load current circuit and which is to be used, for instance, for monitoring a lamp, can be safely detected only in those cases where the load connected to the output interrupts the circuit completely in case of defect. A defective lamp can therefore only be infallibly detected, if ...

- only lamp is connected to the device and if this lamp is defective (e.g. broken filament),
- only one HV halogen lamp is connected to the device and if this lamp is defective,

With other loads or with mixed loads, the detection of a failed lamp is generally not possible. A defective lamp cannot be detected, if...

- LV halogen lamps are connected via conventional or electronic transformers,
- an incandescent lamp is connected in a mixed load configuration together with a conventional or an electronic transformer,
- several incandescent or HV halogen lamps are connected in parallel.

- i** If the load failure detection is enabled in the ETS, the actuator will transmit a message telegram "Load failure detected – 1" to the bus ca. 15 – 20 s after detection of the failure.
- i** A mains voltage failure at an output will always be identified as a load failure, if the mains voltage has failed during more than 15 seconds.
- i** A defective fuse in the primary circuit of a conventional transformer is generally not identified as a load failure.
- i** In the event of a load failure, the actuator sets the switching status to "OFF" and the state of the brightness value to "0" and transmits these values to the bus, if enabled in the ETS.
- i** After an ETS programming operation and after switching on of the bus voltage or of the mains supply, the actuator initializes the "Load failure feedback" objects of all outputs in accordance with their actual state . It should be noted, however, that the "Delay after bus voltage return" parameterized in the ETS must first have elapsed before load failure message telegrams can be transmitted to the bus.

Rectifying a load failure

When the dimming actuator has detected a load failure at an output:

- Disconnect the mains supply of the load circuit concerned.
- Locate the cause of the load failure and rectify.
- Switch the mains supply of the load circuit on again.

The load failure has been reset. After resetting the load failure, the output concerned is deactivated. The output can then again be switched on and off or dimmed as usual.

- ❗ After removal of the load failure and reactivation of the mains voltage in the load circuit, the actuator will repeat the automatic load detection procedure, if the load type parameter is set to "universal" in the ETS. The load detection procedure is characterized by the lamp flickering twice briefly in case of resistive loads and may last up to 10 seconds depending on power supply conditions.
- ❗ If the load failure has been rectified, the actuator will send a "no load failure – 0" message telegram to the bus 15 seconds after the reactivation of the mains supply at the earliest. Otherwise, a new load failure message will be transmitted. No message telegram will be sent within the "Delay after bus voltage return".
- ❗ On deactivation of the mains voltage supply of the dimming actuator (terminals "L" and "N" located beside the bus terminals) the dimming actuator will always – after the "Delay after bus voltage return" parameterized in the ETS – transmit a "no load failure – 0" message telegram to the bus provided the bus voltage is still present. This behaviour is especially important, if the mains voltage supply of the dimming actuator is shut off together with the mains voltage of a load circuit – for instance, when resetting a load failure.

Mains failures

The universal dimming actuator detects mains failures at the load terminals that are caused, for instance, by disturbances in the public low-voltage distribution network.

If a detected mains failure at an output does not last longer than ca. 2 seconds, the dimming actuator reactivates the old brightness value for the outputs concerned and shows no further reaction after return of the mains.

If the mains failure does, however, last longer than ca. 2 seconds, the dimming actuator makes a reset for the outputs concerned when the mains voltage returns. During this reset, the dimming outputs concerned are re-initialized with the ETS parameter values. If the load type is set to "universal" in the ETS. In addition, the actuator will also repeat the automatic load detection procedure. During the initialization after the mains voltage failure, the outputs affected by the mains failure will be shut off. If so parameterized in the ETS, the actuator will then also transmit switching status and value feedback messages to the bus. Thereafter, the outputs can be switched on again as usual. If the mains failure lasts longer than 15 s, a load failure message will moreover be sent to the bus in case the detection function is used (cf. "Load failure detection").

- ❗ In the event of a 'hard' mains interruption – i.e. one caused, for instance, by disconnecting the mains with a line circuit breaker – the detection time for the mains failure at the load terminals can be as long as 7 seconds (instead of 2 seconds).

If the actuator mains supply fails (terminals "L" and "N" located beside the bus connection), all outputs will always be reset on return of the mains. During this reset, the dimming outputs concerned are re-initialized with the ETS parameter values. If the load types are set to "universal" in the ETS, the actuator will also repeat the automatic load detection procedure. After the initialization (return of the mains), the outputs are set in accordance with the setting of the "Behaviour after bus or mains voltage return" parameter.

Short-circuit and overload detection

Each output of the dimming actuator is equipped with a short-circuit/overload and an over-temperature protection.

In the event of a short-circuit or overloading, the load is disconnected automatically after 7s in the phase cut-off mode (capacitive and resistive loads) and after 100 ms in the phase cut-on mode (inductive loads). After shutting off, the actuator transmits a "short-circuit/overload detected – 1" message telegram for the output concerned to the bus, if this type of message is enabled in the ETS.

When the ambient temperature is too high, the load is shut off by the temperature control of the actuator. After cooling, the outputs concerned are automatically reset by the dimming actuator. During this reset, the dimming outputs concerned are re-initialized with the ETS parameter values. If the load type is set to "universal" in the ETS, the actuator will also repeat the automatic load detection procedure. After the initialization, the outputs concerned will be shut off. If so parameterized in the ETS, the actuator will then also transmit switching status and value feedback messages to the bus.

Thereafter, the outputs can be switched on again as usual. If the over-temperature shutoff lasts longer than 15 s, a load failure message will moreover be reported to the bus in case the detection function is used (cf. "Load failure detection").

Rectifying a short-circuit/overload condition

When the dimming actuator, has detected a short-circuit or an overload condition at one of its outputs, the fault must be rectified and the output reset before the dimming output concerned can be switched on again.

The dimming actuator has detected a short-circuit or an overload at one of the outputs:

- Disconnect the mains supply of the load circuit concerned.
- Shut off the mains supply of the dimming actuator (terminals "L" and "N" located beside the bus terminals).
- Locate the cause of the short-circuit or of the overload and rectify.
- Switch the mains supply of the load circuit on again.
- Switch the mains supply of the dimming actuator on again.

The short-circuit or the overload has been reset. After resetting the short-circuit or the overload condition by reactivating the mains supply of the dimming actuator, the output concerned shows the behaviour parameterized in the ETS under "Behaviour after bus or mains voltage return". The output can then again be switched on and off or dimmed as usual.

- i** After removal of the short-circuit / overload and after reactivation of the mains voltage, the actuator will repeat the automatic load detection procedure, if the load type parameter is set to "universal" in the ETS. The load detection procedure is characterized by the lamp flickering twice briefly in case of resistive loads and may last up to 10 seconds depending on power supply conditions.
- i** 7s after reactivation of the mains supply in the phase cut-off mode and 100 ms after reactivation of the mains supply in the phase cut-on mode, the actuator will transmit a "no short-circuit / no overload – 0" message telegram to the bus, if the short-circuit / the overload has been rectified. Otherwise, a new short-circuit/overload message will be transmitted.
- i** In the event of a short-circuit/overload message, the actuator sets the switching status to "OFF" and the state of the brightness value to "0" and transmits these values to the bus, if enabled in the ETS.

- i** Resetting of a detected short-circuit or overload condition and thus of the message transmitted to the bus can also be effected by switching off the output concerned. The output can be switched off by...
- the object "Switching" = 0,
 - the object "Brightness value" = 0,
 - a scene recall with the brightness value = 0,
 - manual control = OFF.

In the same way, a bus voltage failure with subsequent return of the bus voltage triggers a short-circuit / overload reset.

The reset of a short-circuit / overload message by a simple shutoff can be quite helpful in checking whether the short-circuit or the overload condition is still existing or not. If the reactivation of the output concerned will then produce a new short-circuit / overload fault message, the defect in the system has not yet been rectified.

For safety reasons, it is absolutely indispensable to disconnect the mains supply as described in the working instructions when rectifying short-circuit or overload faults.

- i** After an ETS programming operation and after switching on of the bus voltage or of the mains supply, the actuator initializes the objects "Short-circuit / overload feedback" of all outputs depending on their actual state . It should be noted, however, that the "Delay after bus voltage return" parameterized in the ETS must first have elapsed before short-circuit / overload message telegrams can be transmitted to the bus.
- i** On deactivation of the mains supply of the dimming actuator (terminals "L" and "N" located beside the bus terminals) the dimming actuator will always – after the "Delay after bus voltage return" parameterized in the ETS – transmit a "no short-circuit / no overload – 0" message telegram to the bus provided the bus voltage is still present.

2.4 Commissioning

After installation of the universal dimming actuator and connection of the bus line and the mains supply as well as of all electrical loads, the device can be put into operation. The following procedure is generally recommended...

Putting the device into operation

All loads must have been completely installed and connected.



DANGER!

Electric shock in case of accidental contact with live parts. Electric shocks can be fatal. Before working on the device, cut out the mains supply and cover up live parts in the surroundings.



CAUTION

Risk of irreparable damage if the preselected dimming principle (ETS parameter) and the connected load are not compatible. Make sure before commissioning that the software settings are compatible with the load.

- Switch on the bus voltage
Check: The red programming LED must light up when the programming button is being depressed.
 - Assign and program the physical address with the help of the ETS.
 - Download the application data with the ETS
 - Switch on the mains supply of the load circuits.
 - Switch on the mains supply of the dimming actuator (terminals "L" and "N").
The universal dimming actuator adapts itself automatically to the loads and selects the suitable dimming procedure, if the load type parameter is set to "universal" in the ETS. The dimming principle can be predefined during parameterization of the device. In this case, the automatic detection procedure is omitted. The actuator sets the brightness at the outputs to the value predefined in the ETS parameter "Behaviour after bus or mains voltage return".
The device is now ready for operation.
- i** The mains supply of the load circuits and the mains supply of the dimming actuator are switched on at the same time, if, for instance, all supplies lines are connected via a line circuit breaker to the same phase conductor. If the load outputs and the mains terminals of the dimming actuator are supplied with power from different phase conductors or via several line circuit breakers, the load circuits should always be switched on before the mains supply of the dimming actuator is switched on. Thus, it can be ensured that the universal dimming actuator can correctly detect the loads connected even in case of great length of cable.
- i** If a short-circuit or an overload is being detected during commissioning at one of the load outputs, the dimming actuator cannot adapt itself to the load. In such case, the fault must first be rectified and the short-circuit or overload condition be reset (cf. "Rectifying a short-circuit/overload condition" above).

2.5 Operation

The universal dimming actuator is equipped with an electronic manual control function for all outputs. The keypad with 4 function keys and 3 status LEDs on the front panel of the device can be used for setting the following modes of operation...

- bus control: operation with touch sensors or other bus devices
- temporary manual control: manual control locally via keypad, automatic return to bus control,
- permanent manual control: local manual control with keypad.

- i** The operating modes can also be disabled by means of parameters in the ETS.
- i** When the manual control mode is active, the outputs cannot be controlled via the bus.
- i** Manual control is possible only while the actuator is supplied with power from the mains. The manual operating mode ends in case of bus voltage return or mains voltage failure.
- i** During bus operation, the manual mode can be disabled by means of a telegram. The manual mode is terminated on activation of the disabling function.
- i** Further details concerning the manual mode, especially with respect to the possible parameter settings and the interaction with other functions of the dimming actuator can be found in chapter 4. "Software description" of the present documentation.

Controls and indicators for manual control

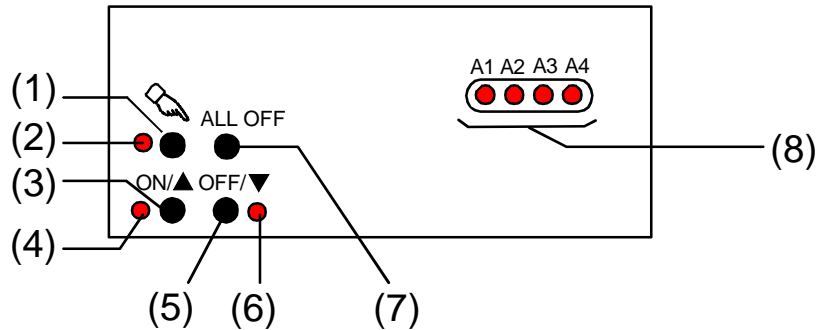

Fig. 3: Controls and indicators for manual control

- (1) Key : activation / deactivation of manual control
- (2) LED : indicates permanent manual control when the LED is ON.
- (3) key ON/: brief press: output ON / long press: increase brightness at output.
- (4) Status LED ON/: indicates an activated output in the manual control mode when the LED is ON (brightness: 1...100) %).
- (5) Key OFF/: brief press: output OFF / long press: reduce brightness at output.
- (6) Status LED OFF/: indicates an activated output in the manual control mode when the LED is ON (brightness: 0 %).
- (7) Key ALL OFF
all outputs are switched off if pressed (only in the permanent manual control mode).
- (8) Status LED:
indicate the state of the individual outputs. an LED is on when an output is switched on (brightness: 1...100 %). one of the LEDs flashes, when the corresponding output has been selected with the key in the manual mode.

Priorities

The universal dimming actuator distinguishes between different functions that can be active at an output. In order to prevent conflicting output states, each available function has a certain priority. The function with the higher priority overrides the function with the lower priority.

- 1st priority: Manual control (highest priority)
- 2nd priority: forced-control or disabling function
- 3rd priority: direct bus operation (objects "Switching" & "Dimming" & "Brightness value", scenes, central function)

Activating the temporary manual control

Manual control has been enabled in the ETS.

- Press the  key briefly (< 1 s).

The status LED of output 1 flashes (LED  remains off).



 After 5 s without key-press, the actuator returns automatically to the bus mode.

Deactivating temporary manual control

The temporary manual control mode has been activated.

- No key-press for 5 s

- or -

- select all outputs one after another by pressing briefly the  key. Thereafter, press the  key once again.

- or -

- shut off the mains supply or make a bus reset (bus voltage return).

The temporary manual control mode is terminated. The state indicator LEDs A1...A4 show the status for bus operation, when the mains voltage is on.

 During a shutoff of the temporary manual control mode, the brightness state selected in the manual mode does not change. If, however, a forced-control or a disabling function was activated via the bus during the manual mode, the dimming actuator executes the disabling or forced-control functions.

Activating the permanent manual control mode

The manual control mode has been enabled in the ETS. The bus mode or the temporary manual control mode has been activated.

- Press the  key for at least 5 s.

The status LED  is illuminated. The state indicator LED of output 1 is flashing. The permanent manual control mode is now activated.

Deactivating the permanent manual control mode

The permanent manual control mode has been activated:

- Press the  key for at least 5 s.

- or -

- shut off the mains supply or make a bus reset (bus voltage return).

The status LED  goes out. The state indicator LEDs A1...A4 show the status for bus operation, when the mains voltage is on.

 Depending on the parameterization of the dimming actuator in the ETS, the actuator will either retain the brightness values last set at the outputs (by direct operation, forced-control / disabling function) or show no reaction when the manual control mode is deactivated.

Operating an output in the manual control mode

The manual control mode (permanent or temporary) has been activated.

- Select the desired output: Press the  key briefly (several times, if necessary).
The state indicator LED of the selected output A1...A4 is flashing. The status LED "ON/▲" (1...100 %) or "OFF/▼" (0 %) in the keypad indicate the brightness of the output.
- Operate the output by pressing the ON/▲ or the OFF/▼ key.
Brief press: Switching on and off.
Long press: increase / reduce the brightness.
Long press & release: stop dimming process.
The selected output executes the corresponding commands immediately.

 An output cannot be switched or dimmed in case of a load failure or a short-circuit or when the dimming actuator is busy with the automatic load detection procedure.

Shutting off all outputs





The permanent manual control mode has been activated.

- Press the ALL OFF key.
All outputs shut off immediately (brightness: 0 %). The outputs are not interlocked. They can again be operated individually after shutoff.
-  The "ALL-OFF" function is not available in the temporary manual control mode.

Disabling the bus control mode for individual outputs by manual operation

The permanent manual control mode has been activated.

Disabling of the bus control mode must have been enabled in the ETS.

- Select an output: Press the  key briefly (several times, if necessary).
The state indicator LED of the selected output A1...A4 is flashing. The status LED "ON/▲" (1...100 %) or "OFF/▼" (0 %) in the keypad indicate the brightness of the output.
- Press the ON/▲ and the OFF/▼ key at the same time for at least 5 s
The selected output is disabled (the output can no longer be controlled via the bus). The state indicator LED of the selected output A1...A4 is flashing fast.
-  To unlock, proceed in the same way.
-  An output that has been disabled manually can thereafter only be operated in the permanent manual mode.
-  When a disabled output is selected in the manual control mode, the respective status LEDs flashes twice briefly at intervals.

3 Technical data

Type of protection:	IP 20
Safety class:	III
Mark of approval:	KNX / EIB
Ambient temperature:	-5 °C ... +45 °C
Max. housing temperature:	TC = + 75 °C
Storage / transport temperature:	-25 °C ... +70 °C (storage above + 45 °C reduces the lifetime)
Mounting position:	any position (output screw terminals preferably at the top)
Minimum distances:	none
Type of fastening:	Snap-fastening on DIN rail in closed cabinets (e.g. small distributions, etc.) / KNX / EIB data rail not required.
KNX / EIB supply	
Voltage:	21 ... 32 V DC SELV
Power consumption:	typically 150 mW
Connection:	standard KNX/EIB bus connection terminal
External supply	
Voltage:	190 ... 230 V AC +10 % / -15 %, 50/60 Hz
Power consumption:	approx. 1 W (without load at outputs)
Connection:	with screw terminals: 0.5 ... 4 mm ² single wire and stranded wire without ferrule 0,5 ... 2,5 mm ² stranded wire with ferrule Max. tightening torque: 0.8 Nm
Total power loss:	max. 8.5 W (with maximum load at all outputs)
Response to bus voltage failure:	depending on parameterization (cf. chapter 4 "Software description")
Response to mains voltage failure:	All outputs shutting off (cf. chapter 2.3 "Fitting and electrical connection – Mains failures")
Response to bus voltage return:	depending on parameterization (cf. chapter 4 "Software description")
Response to mains voltage return:	All outputs are initialized and, if applicable, redetected (cf. chapter 2.3 "Fitting and electrical connection – Mains failures").

Technical data (continued)

Outputs:

Number:	4 (electronic, MosFETs)
Connection:	with screw terminals: 1.5 ... 4 mm ² single wire and stranded wire without ferrule 1.5 ... 2,5 mm ² stranded wire with ferrule Max. tightening torque: 0.8 Nm
Line length per output:	max. 100 m
Load ratings per output:	
230 V incandescent lamps:	20 ... 210 W
230 V halogen lamps:	20 ... 210 W
LV halogen lamps:	
conventional transformers:	20 ... 210 VA
TRONIC transformers:	20 ... 210 W
Mixed load resistive-inductive:	20 ... 210 W / VA
Mixed load resistive-capacitive:	20 ... 210 W
Mixed load inductive / capacitive:	not permitted
Motor loads	not permitted
Power diagram:	

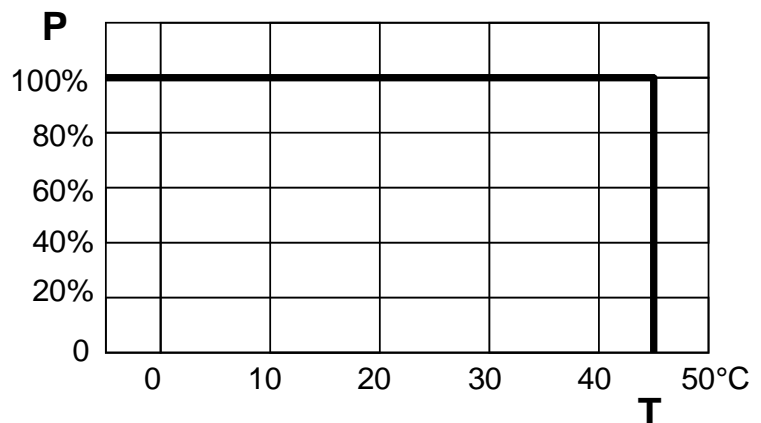

P = output power

T = ambient temperature

Extension of power:

i When the load capacity of a dimming output is exhausted, the power rating of the actuator can be increased with Jung power boosters. The selected boosters must be adapted to the dimmer and to the load. The information contained in the operating instructions of the corresponding power booster must be observed.

If the load rating of an output is enhanced by universal power boost units, the maximum brightness (ETS parameter) is to be reduced to 90 % max.

4 Software information

4.1 Software specifications

ETS search paths: Illumination / dimmer / Universal dimming actuator 4-gang REG
 BAU used: TPUART + μ C
 KNX/EIB type class: 3b - Gerät mit zert. PhL + stack
 Configuration: S-mode standard
 PEI type "00"_{Hex} / "0"_{Dez}
 PEI connector kein Verbinder

Applications:

No.	Summarized description:	Name:	Version:	Executable from mask version:
1	Multi-functional control of up to 4 dimming outputs with presettable dimming behaviour, time functions, scenes, disabling function or forced-control, soft-ON or soft-OFF functions and extended feedback messages. Centralized switching of all outputs is also available. In addition, the brightness levels of the outputs in case of bus voltage failure or bus / mains voltage return and after an ETS programming operation can be preset separately.	Dimming 301A01	0.1 for ETS 2 and ETS 3.0 versions a...c	705
		Dimming 301A11	1.1 for ETS3.0 from version d onwards	

4.2 Software "Dimming 301Ax1"

4.2.1 Scope of functions

General:

- Manual operation of the outputs independent of the bus (site operation possible as well).
- Central function function for common control of all outputs.
- Delay for actively transmitted feedback messages after bus voltage return.

Channel-oriented functions:

- Independent control of up to 4 dimming outputs. Each output offers the full scope of functions without any restrictions. All channel-oriented functions can be parameterized separately for each output. This feature permits independent and multi-functional control of the dimming outputs.
- Switching feedback: active (optionally also cyclical) transmission feedback function to the bus or passive feedback function (by object readout) .
- Selection of load type and thus determination of dimming principle for each output:
 - universal (with automatic load detection procedure),
 - electronic transformer (capacitive / phase cut-off principle),
 - conventional transformer (inductive / phase cut-on principle).
- Presetting of brightness limit values (basic brightness and maximum brightness).
- Dimming behaviour (also fading) and dimming characteristics parameterizable.
- Soft-ON and soft-OFF functions.
- In case of short-circuit / overload and of load failure, message telegrams can be transmitted separately to the bus for each output . A feedback message concerning load type connected is also possible.
- Disabling function or alternatively forced-control function parameterizable for each output. Blinking of connected lamps is possible during the disabling function .
- Timing functions (ON-delay, OFF-delay, staircase lighting timer, also with pre-warning function)
- Operating hours counter independently usable for each output.
- Outputs can be integrated into up to 8 light-scenes:
- Behaviour in case of bus voltage failure and bus voltage return as well as after ETS programming presettable for each output.

4.2.2 Software information

ETS project design and start-up

For project design and start-up of this device it is recommended to use the ETS3.0d. Advantages with regard to downloading (significantly shorter loading times) and parameter programming can be expected only if this ETS patch version or later versions are used. The advantages consist in the use of the new mask version 7.5 and the parameter presentation of the ETS3.

The product database required for the ETS3.0d is offered in the *.VD4 format. The corresponding application program has version number "1.1". For the ETS2 and for older versions of the ETS3, a separate product database in the *.VD2 format is available. The application program for these ETS versions is version number "0.1".

As far as the scope of functions of the parameters described in this documentation is concerned, there is no difference between the two application programs.

When older ETS versions are updated to the level of version ETS3.0d or to that of later versions, an additional tool in the form of an ETS add-in is available. This tool is capable of converting older product databases of application version "0.1", for instance from existing ETS2 project designs, into the new application format (version "1.1"). This feature permits making use of the advantages of the ETS3.0d application in an easy way and without any changes. The ETS3 add-in can be obtained separately from the manufacturer and is free of charge.

Safe-state mode

If the device - for instance as a result of errors in the project design or during start-up - does not work properly, the execution of the loaded application program can be halted by activating the safe-state mode. In the safe-state mode, the outputs cannot be controlled via the bus. The only mode that can be activated is the manual control mode. The actuator remains passive since the application program is not being executed (state-of-execution: terminated). Only the system software is still functional so that the ETS diagnosis functions and also the programming of the device continue to be possible.

Activating the safe-state mode

- Shut off the bus and the mains voltage supply.
- Press the programming button and keep it pressed.
- Switch on the bus or the mains voltage. Release the programming button only after the programming LED starts blinking slowly.

The safe-state mode is activated. With a new brief press on the programming button, the programming mode can be switched on and off as usual also in the safe-state mode. The programming LED will nevertheless continue to blink independently of the programming mode as long as the safe-state mode is active.

i The safe-state mode can be terminated by switching off the supply voltage (bus and mains) or by an ETS programming operation.

i For activation of the safe-state mode it is not necessary that the bus voltage be on.

Unloading the application program

The application program can be unloaded with the ETS. In this case, the outputs can only be operated manually.

4.2.3 Object table

Number of communication objects:	75
Number of addresses (max):	254
Number of assignments (max):	255
Dynamic table management:	no
Maximum table length:	---

Objects affecting several channels:

Function:	Manual control				
Object	Function	Name	Type	DP type	Flag
 0	Disable	Manual control	1 bit	1.003	C, W, – (R) ¹
Description:	1-bit object for disabling the keys for manual control on the device. The polarity can be parameterized.				

Function:	Manual control				
Object	Function	Name	Type	DP type	Flag
 1	Status	Manual control	1 bit	1.002	C, -, T, R ¹
Description:	1-bit object for manual control status transmission The object is "0", when the manual control mode is deactivated (bus control). The object is "1", when the manual control mode is activated. The user can parameterize whether the temporary or the permanent manual control mode will be indicated as status information or not.				

Function:	Central function				
Object	Function	Name	Type	DP type	Flag
 2	Switching	Central function	1 bit	1.001	C, W, – (R) ¹
Description:	1-bit object for Central function of outputs assigned. The polarity can be parameterized.				

¹ Each communication object can be read out. For reading, the R-flag must be set.

Channel-oriented objects:

Function: Output switching						
Object	Function	Name	Type	DP type	Flag	
☐← 3, 21, 39, 57	Switching	Output 1 ... 4	1 bit	1.001	C, W, – (R) ¹	
Description: 1-bit object for switching an output on and off ("1" = switching on / "0" = switching off).						
Function: Output relative dimming						
Object	Function	Name	Type	DP type	Flag	
☐← 6, 24, 42, 60	Dimming	Output 1 ... 4	4 bit	3.007	C, W, – (R) ¹	
Description: 4-bit object for relative dimming of an output.						
Function: Output absolute dimming						
Object	Function	Name	Type	DP type	Flag	
☐← 7, 25, 43, 61	Brightness value	Output 1 ... 4	1 byte	5.001	C, W, – (R) ¹	
Description: 1-byte object for presetting an absolute dimming value (brightness value 0...255) from the bus.						
Function: Switching feedback						
Object	Function	Name	Type	DP type	Flag	
☐← 8, 26, 44, 62	Switching feedback	Output 1 ... 4	1 bit	1.001	C, –, T, R ^{1 2}	
Description: 1-bit object for reporting the switching status ("1" = on / "0" = off) back to the bus.						
Function: Feedback absolute dimming						
Object	Function	Name	Type	DP type	Flag	
☐← 9, 27, 45, 63	Brightness value feedback	Output 1 ... 4	1 byte	5.001	C, –, T, R ^{1 2}	
Description: 1-byte object for reporting a preset dimming value (brightness value 0...255) back to the bus.						

¹ Each communication object can be read out. For reading, the R-flag must be set.

² Depending on parameterization, feedback objects are either actively transmitting (T-flag set) or passively readable (R-flag set).

Function: Staircase function

Object	Function	Name	Type	DP type	Flag
 4, 22, 40, 58	Staircase timer start / stop	Output 1 ... 4	1 bit	1.010	C, W, - (R) ¹

Description: 1-bit object for activation or deactivation of the ON-time of the Staircase function of an output ("1" = on / "0" = off).

Function: Staircase function

Object	Function	Name	Type	DP type	Flag
 5, 23, 41, 59	Staircase function factor	Output 1 – 4	1 byte	5.010	C,W, -, (R) ¹

Description: 1-byte object for setting the time factor for the lighting time of the staircase timer function (value range: 0 ... 255).

Function: Disabling function

Object	Function	Name	Type	DP type	Flag
 10, 28, 46, 64	Disable	Output 1 ... 4	1 bit	1.003	C, W, - (R) ¹

Description: 1-bit object for disabling of an output (polarity parameterizable).

Function: Forced-control function

Object	Function	Name	Type	DP type	Flag
 11, 29, 47, 65	Forced-control position	Output 1 ... 4	2 bit	2.001	C, W, - (R) ¹

Description: 2-bit object for the forced-control of an output. The polarity is predefined by the telegram.

Function: Scenes

Object	Function	Name	Type	DP type	Flag
 12, 30, 48, 66	Scene extension	Output 1 ... 4	1 byte	18.001	C, W, - (R) ¹

Description: 1-byte object for recalling scenes or for storing new scene values.

Function: Short-circuit and overload monitoring

Object	Function	Name	Type	DP type	Flag
 14, 32, 50, 68	Short-circuit / overload feedback	Output 1 ... 4	1 bit	1.005	C, -, T, R ¹

Description: 1-bit object for signalling a short-circuit or an overload at an output ("1" = short-circuit / overload / "0" = no short-circuit / overload).

¹ Each communication object can be read out. For reading, the R-flag must be set.

Function: Load failure monitoring

Object	Function	Name	Type	DP type	Flag
 15, 33, 51, 69	Load failure feedback	Output 1 ... 4	1 bit	1.005	C, -, T, R ¹

Description: 1-bit object for signalling a load failure at an output ("1" = load failure / "0" = no load failure).

Function: Operating hours counter

Object	Function	Name	Type	DP type	Flag
 16, 34, 52, 70	Limit / start value ³ operating hours counter	Output 1 ... 4	2 byte	7.007	C, W, - (R) ¹

Description: 2-byte object for external preset of a limit / start value for the operating hours counter of an output. Value range: 0 ... 65535

Function: Operating hours counter

Object	Function	Name	Type	DP type	Flag
 17, 35, 53, 71	New start operating hours counter	Output 1 ... 4	1 bit	1.015	C, W, - (R) ¹

Description: 1-bit object for resetting the operating hours counter of an output ("1" = restart, "0" = no reaction).

Function: Operating hours counter

Object	Function	Name	Type	DP type	Flag
 18, 36, 54, 72	Value operating hours counter	Output 1 ... 4	2 byte	7.007	C, -, T, R ¹

Description: 2-byte object for transmission or readout of the current count of the operating hours counter. The value of the communication object is not lost after a bus voltage failure and is actively transmitted to the bus after bus voltage return or after programming with the ETS. In the as-supplied state, this value is "0".

¹ Each communication object can be read out. For reading, the R-flag must be set.

³ Limit value object or start value object depending on type of counter programmed as operating hours counter.

Function: Operating hours counter

Object	Function	Name	Type	DP type	Flag
 19, 37, 55, 73	Runout operating hours counter	Output 1 ... 4	1 bit	1.002	C, -, T, R ¹

Description: 1-bit object for signalling that the operating hours counter has run out (up-counter = limit value reached / down-counter = value "0" reached). In case of feedback, the object value is transmitted actively to the bus ("1" = message active / "0" = message inactive). The value of the communication object is not lost after a bus voltage failure and is actively transmitted to the bus after bus voltage return or after programming with the ETS.

Function: Load type feedback

Object	Function	Name	Type	DP type	Flag
 20, 38, 56, 74	Load type feedback	Output 1 ... 4	1 byte	20.xxx	C, -, T, R ¹

Description: 1-byte object for signalling the preset load type of an output.
 "0" = undefined (no automatic load detection: no mains voltage / short-circuit),
 "1" = capacitive (preset via parameter),
 "2" = inductive (preset via parameter),
 "3" = universal, automatic adaptation to capacitive or resistive load,
 "4" = universal, automatic adaptation to inductive load,
 "5 ... 255" not used.

¹ Each communication object can be read out. For reading, the R-flag must be set.

4.2.4 Functional description

4.2.4.1 Device-independent functional description

Manual control

The universal dimming actuator is equipped with an electronic manual control function for all outputs. The keypad with 4 function keys and 3 status LEDs on the front panel of the device can be used for setting the following modes of operation...

- Bus control mode: operation with touch sensors or other bus devices
- Temporary manual control mode: manual operation locally via keypad, automatic return to bus control,
- Permanent manual control mode: local manual operation with keypad.

The operation of the function keys, the control of the outputs and the status indication are described in detail in chapter "2.5. Operation".

The following paragraphs are to give a more detailed description about the parameterization, status feedback, disabling via bus control and interaction with other functions of the dimming actuator in the case of activation and deactivation of the manual control mode.

Manual operation is only possible when the actuator is supplied with power from the mains. In the as-supplied state of the actuator the manual control mode is fully enabled. In this unprogrammed state, all outputs can be operated manually so that fast function checking of the connected drives (e.g. on the construction site) is possible.

After the first start-up of the actuator with the ETS, the manual control mode can be separately enabled or disabled for different states of operation. Manual operation can, for instance, be disabled when the device is in the bus mode (bus voltage applied). Another option consists in the complete disabling of the manual control mode only in case of bus voltage failure. This means that manual operation can be completely disabled not only during the bus mode, but also only in case of bus failures.

Enabling the manual control mode

Manual control for the different states of operation is enabled or disabled by means of the parameters "Manual control in case of bus voltage failure" and "Manual control during bus mode".

- Set the parameter "Manual control in case of bus voltage failure" to "enabled".
Manual control is then basically enabled when the bus voltage is off. This setting corresponds to the setting of the actuator as supplied.
- Set the parameter "Manual control in case of bus voltage failure" to "disabled".
Manual control is completely disabled when the bus voltage is off. In this case, operation via the bus is not possible either so that the outputs of the actuator can no longer be actuated.
- Set the parameter "Manual control during bus mode" to "enabled".
Manual control is then basically enabled when the bus voltage is on. The outputs of the actuator can be operated via the bus or manually. This setting corresponds to the setting of the actuator as supplied.

- Set the parameter "Manual control during bus mode" to "disabled".
Manual control is completely disabled when the bus voltage is on. In this configuration, the actuator outputs can only be operated via the bus.
- ❗ An active manual control mode will not be terminated when the bus voltage fails, even if the parameter "Manual control in case of bus voltage failure" is set to "disabled". The manual mode will be disabled only after it has been terminated.
- ❗ Further parameters and communication objects of the manual control are visible only if the parameter "Manual control during bus mode" is set to "enabled". For this reason, disabling function, status message and bus control disable can only be configured if the parameter is set as above.

Presetting the behaviour at the beginning and at the end of manual control mode

The manual control mode is divided into the temporary and the permanent manual control mode. Depending on these modes, the actuator behaves differently, especially at the end of the control mode. It should be noted that the operation via the bus, i.e. control of the outputs by direct operation (switching / dimming / brightness value / scenes / central) or by the disabling or forced-control functions is always disabled while the manual control mode is active. This is to say that the manual control mode has the highest priority.

Behaviour at the beginning of manual control:

There is no difference between temporary or permanent manual control as far as the behaviour at the beginning of manual control is concerned. The activation of the manual control mode leaves the brightness levels unchanged.

Special case: flash mode with disabling function: Lamp flashing in a disabling function will be interrupted at the beginning of manual control. The brightness is switched to the brightness after switching on. The switching status is indicated as "ON".

Active Forced-control position or disabling functions can be overridden by the manual control mode. These functions are reactivated after deactivation of the manual mode unless they have not been cancelled via the bus.

Behaviour at the end of the manual control mode:

The behaviour at the end of manual control differs between temporary and permanent manual control. The temporary manual mode is shut off automatically when the last output has been selected and when the selection key $\&$ is pressed once again. During a shutoff of the temporary manual control mode, the dimming actuator goes back to 'normal' bus operation and does not change the brightness levels selected by manual operation. If, however, a Forced-control position or a disabling function was activated via the bus before or during the manual mode, the dimming actuator executes these higher-ranking functions for the outputs concerned.

The permanent manual control mode is shut off, when the selection key $\&$ is pressed for more than 5 s. Depending on the parameterization of the actuator in the ETS, the outputs will be set to the state last adjusted in the manual mode or to the state internally retained (direct operation, forced-control, disabling) when the permanent manual mode is shut off. The parameter "Behaviour at the end of permanent manual control during bus mode" defines the corresponding reaction.

- Set the parameter "Behaviour at the end of permanent manual control during bus mode" to "no change".

All telegrams received during an active permanent manual control mode for direct operation (switching, dimming, brightness value, central, scenes) will be rejected. After the end of the permanent manual control mode, the current brightness level of all outputs remains unchanged. If, however, a Forced-control position or a disabling function was activated via the bus before or during the manual mode, the dimming actuator executes these higher-ranking functions for the outputs concerned.
- Set the parameter "Behaviour at the end of permanent manual control during bus mode" to "track outputs".

During an active permanent manual control all incoming telegrams are internally tracked. At the end of manual control, the outputs are set to the brightness levels last tracked. If, however, a Forced-control position or a disabling function was activated via the bus before or during the manual mode, the dimming actuator executes these higher-ranking functions for the outputs concerned.
- ❗ The behaviour at the end of the permanent manual control when the bus voltage is off (only manual control) is permanently set to "no change".
- ❗ The control operations triggered in the manual control mode will be transmitted via feedback objects to the bus, if enabled and if actively transmitting.
- ❗ On return of bus voltage or after programming with the ETS an activated manual control mode will always be terminated. In this case, the parameterized or predefined behaviour at the end of manual control will not be executed. The dimming actuator executes the behaviour parameterized for the event of bus/mains voltage return or after an ETS programming operation.

Presetting the manual control mode disabling function

The manual control mode can be separately disabled via the bus, even if it is already active. As soon as a disabling telegram is received via the disabling object when the disabling function is enabled, the actuator terminates an activated manual control mode immediately and locks the function keys on the device panel. The telegram polarity of the disabling object is parameterizable.

The manual control mode during bus operation must have been enabled.

- Set the parameter "Disable function for manual control?" on parameter page "Manual control" to "yes".

The manual control mode disabling function is enabled and the disabling object is visible.
- Select the desired telegram polarity in the "Polarity of disable object for manual control" parameter.
- ❗ If the polarity is "0 = disabled; 1 = enabled", the disabling function is active immediately on return of bus/mains voltage or after an ETS programming operation (object value "0"). To activate the manual control in this case, an enable telegram "1" must first be sent to the disabling object.
- ❗ In case of bus voltage failure, disabling via the disabling object is always inactive (depending on parameterization, the manual control is then either enabled or completely disabled). After return of bus voltage, a disabling function that was active beforehand is always inactive in case of non-inverted polarity of the disabling object.

- i** In case of a mains supply failure (no mains voltage at terminals "L" and "N"), disabling via the disabling object will be deactivated in case of non-inverted polarity.
- i** When an active manual control is terminated by a disable, the actuator will also transmit a "Manual control inactive" status telegram to the bus, if the status messaging function is enabled.

Presetting the status messaging function for the manual control mode

The dimming actuator can transmit a status message to the bus via a separate object, when the manual control mode is being activated or deactivated. The status telegram can only be transmitted when the bus voltage is on. The polarity of the status telegram can be parameterized.

The manual control mode during bus operation must have been enabled.

- Set the parameter "Transmit manual control status?" on the "Manual control" parameter page to "yes".

The status messaging function of the manual mode is enabled and the status object is visible.

- Specify in the "Function and polarity of status object" parameter whether the status telegram is generally a "1" telegram whenever the manual control mode is activated or only in those cases where the permanent manual mode is activated.

- i** The status object is always "0", when the manual control mode is deactivated.
- i** The status will be actively transmitted to the bus ("0") only if a manual control that was activated during bus voltage failure is terminated by the return of the bus voltage. The status telegram is in this case transmitted without delay.
- i** When an active manual control is terminated by a disable, the actuator will also transmit a "Manual control inactive" status telegram to the bus.

Presetting the bus control disabling function

Individual dimming outputs can be disabled locally so that the connected consumers no longer be controlled via the KNX/EIB. A bus control disable is effected by local operation in the permanent manual mode and indicated by the rapidly flashing status LED on the front panel of the device. The disabled outputs can then only be actuated in the permanent manual control mode.

The manual control mode during bus operation must have been enabled.

- Set the parameter "Bus mode of individual groups can be disabled?" on the "Manual control" parameter page to "yes".

The bus control disabling function is enabled and can be activated locally. If the alternative setting "no" is selected for this parameter, the activation of bus control disable in the permanent manual mode is not possible.

- i** A locally activated disable has the highest priority. Other functions of the actuator that can be activated via the bus (e.g. Forced-control position or disabling function) are then overridden. Depending on the parameterization of the actuator in the ETS, the groups will be set to the state last adjusted in the manual mode or to the state internally tracked (direct operation, forced-control, disabling function lock) when the disabling function is released and the permanent manual mode shut off thereafter.
- i** A locally activated bus control disable will not be reset in case of bus voltage failure or bus voltage return. A supply voltage failure (mains voltage failure) or an ETS programming operation will always deactivate the bus control disable.

4.2.4.2 Description of channel-independent functions

Delay after bus / mains voltage return

To reduce telegram traffic on the bus line after activation of the bus voltage (bus reset) or also of the mains voltage, after connection of the device to the bus line or after programming with the ETS, it is possible to delay all actively transmitted feedback telegrams of the actuator. For this purpose, a channel-independent delay can be specified (parameter "Delay after bus voltage return" on parameter page "General". Feedback telegrams for bus initialization will therefore be transmitted to the bus only after the parameterized time has elapsed.

Which of the channel-independent feedback telegrams is actually delayed and which is not can be specified for each dimming output channel and for each feedback function separately.

- i** The delay has no effect on the behaviour of the individual output. Only the feedback telegrams are delayed. The outputs can also be activated during the delay after bus voltage return.
- i** A setting of "0" for the delay after bus voltage return deactivates the delaying function altogether. In this case, all feedback telegrams, if actively transmitted, will be transmitted to the bus without any delay.
- i** All actively transmitting objects of the operating hours counters or the signalling objects "load failure", "short-circuit / overload" and "load type" are considered as feedback objects. In this case, however, all feedback telegrams are always transmitted with a delay depending on the parameter selected under "Delay after bus voltage return".
- i** After return of the bus voltage, the message "manual control status" will be actively transmitted to the bus ("0") only if a manual control that was activated during bus voltage failure is terminated by the return of the bus voltage. In this case, the status telegram is always transmitted without delay.
- i** Due to system constraints, there will always be a short delay after an ETS programming operation even if the parameter "Delay after bus voltage return" is set to "0".
- i** Even after actuator supply voltage failure (terminals "L" and "N"), telegrams will still be transmitted to the bus, if the bus voltage is still on. In case of a mains voltage failure, the feedback telegrams are transmitted with after the delay parameterized in the ETS.

Presetting a feedback delay

Only those feedbacks that are enabled and preset as actively transmitting ones can be parameterized with regard to the transmission behaviour after bus voltage return.

- Set the parameter "Time delay for feedback telegram after bus voltage return?" to "yes". This parameter is listed on the parameter page of the corresponding switching status or brightness value feedback for an output.

In this case, the feedback telegram will only be transmitted at the end of the delay after bus / mains voltage return. As an alternative (setting "no"), the feedback telegram can be transmitted to the bus without any delay.

Central function

The actuator offers the possibility of linking selected individual or all outputs with a 1-bit central communication object. The behaviour in case of activating an output via the central function is comparable to a central group address linked with all "Switching" objects.

The outputs assigned to the central function are activated in accordance with the central object value received. The polarity of the central telegram can be inverted in the corresponding parameter.

The behaviour of the outputs is identical with the 'normal' activation via the "Switching" objects (same priority – last switching command is executed – cf. fig. 4). Thus, all 'secondary' functions such as timing or additional functions are included as well.

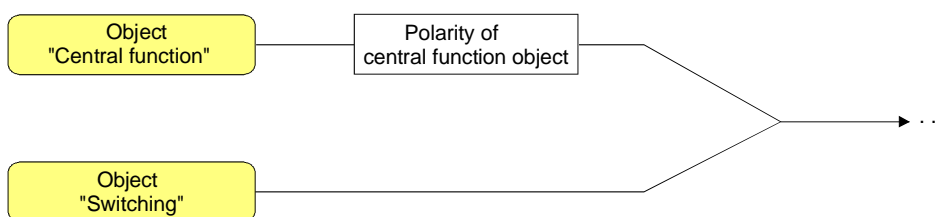

Fig. 4: Functional diagram "Centralized switching"

Enabling the central function

- Enable the central function on parameter page "General" by setting the "Central function ?" parameter to "yes".

When the function is activated, the "Central function" communication object is visible.

Assigning outputs to the central function

Each dimming output can be assigned independently to the central function.

The central function must have been enabled on parameter page "General". The assignment has otherwise no effect on the output.

- Set the "Assignment to the central function?" parameter on the "Ax-General" page (x = number of output) to "yes".

The corresponding output is now assigned to the central function. The connected consumers can be switched on or off from a centrally.

- ⓘ The switching state set by the central function is tracked in the feedback objects and also transmitted to the bus, if these objects are actively transmitting objects. The switching state set by a central function is not tracked in the "Switching" objects.
- ⓘ After a bus / mains voltage return or after programming with the ETS, the central function is always deactivated (object value "0").

4.2.4.3 Description of channel-oriented functions

Definition of load type and load type feedback

The universal dimming actuator works on the phase cut-on or cut-off principle and permits switching and dimming of incandescent lamps, HV halogen lamps and LV halogen lamps with conventional and electronic transformers. The device automatically detects the load characteristics of the connected consumer separately for each output and selects the appropriate dimming principle. Alternatively, the dimming principle can also be preset by means of a parameter in the ETS without automatic detection.

Defining the load type

The parameter "Type of connected load" on parameter page "Ax – General" (x = number of output 1...4) defines the dimming procedure for each of the dimming outputs.



CAUTION

Risk of irreparable damage if the preselected dimming principle (ETS parameter) and the connected load are not compatible.

Before changing the load type, disconnect the mains supply of the dimming actuator and the load circuit concerned. Check the parameter settings and correct, if needed.



CAUTION

Risk of irreparable damage with mixed loads.

Do not connect capacitive loads (e.g. electronic transformers) together with inductive loads (e.g. conventional transformers) to the same dimming output.

- Set the parameter to "universal" (with automatic detection)".
The dimming output can be adapted to all types of loads. After an ETS programming operation, after switching on of the mains supply of the actuator (terminals "L" and "N") or after switching on of the mains supply of a load output, the actuator performs the automatic detection procedure and adapts itself to the connected load. The load detection procedure is characterized by the lamp flickering twice briefly in case of resistive loads and may last up to 10 seconds depending on power supply conditions.
 - Set the parameter to "electronic transformer (capacitive / phase cut-off)".
The dimming output is permanently set to the phase cut-off principle. The automatic load detection is omitted. The output can be connected to resistive loads or to electronic transformers.
 - Set the parameter to "conventional transformer (inductive / phase cut-on)".
The dimming output is permanently set to the phase cut-on principle. The automatic load detection is omitted. The output can be connected to conventional transformers.
- i** In the as-supplied state of the actuator, the dimming principle is set to "universal" for all outputs.
- i** When the type of load connected to an output is changed, it may be the case that the dimming principle must be changed, too. The procedure required for changing the load type is described in chapter 2.3 "Fitting and electrical connection".

Enabling load type feedback

The universal dimming actuator has a load type feedback function permitting to report the preset or automatically determined load type back to the bus. This feature allows to identify the dimming principle used by the output without having to know the ETS parameter settings. In the universal mode it is moreover possible to determine whether the dimming output works with the phase cut-on or with the phase cut-off principle.

The load type is reported back via the 1-byte object "Load type feedback" existing for each output. The object value is coded as shown in table 1.

Object value	Meaning
0	load type undefined (mains voltage failing, short-circuit, etc. / automatic load detection not possible)
1	load type capacitive / resistive (preset in ETS parameter)
3	load type inductive (preset in ETS parameter)
4	load type universal, capacitive or resistive load successfully detected
5 ... 255	load type universal, inductive load successfully detected
	not used

Table 1: Value code of "Load type feedback" object

- Set the parameter "Load type feedback ?" on parameter page "Ax - Enabled functions" (x = number of output 1...4) to "yes".

The load type feedback function is now enabled and active. A feedback telegram is actively transmitted to the bus after return of the bus or the mains voltage, in case of a mains voltage failure (with value "0") and after an ETS programming operation. If the load type is set to "universal", a telegram is moreover transmitted whenever an automatic re-detection procedure is performed (e.g. after load failure or short-circuit / overload).

- ⓘ It should be noted, however, that after an ETS programming operation and after switch-on of the bus voltage or of the mains supply of the actuator, the "Delay after bus voltage return" parameterized in the ETS must first have elapsed before a load type message telegram can be transmitted to the bus.

Short-circuit / overload feedback

Each output of the dimming actuator is equipped with a short-circuit/overload protection. In the event of a short-circuit or overloading, the load is disconnected automatically after 7s in the phase cut-off mode (capacitive and resistive loads) and after 100 ms in the phase cut-on mode (inductive loads). For the outputs concerned, the actuator can transmit a "short-circuit/overload" feedback telegram to the bus after shut-off, if feedback is enabled in the ETS.

The following instructions describe how to enable a short-circuit/overload feedback message and how such message is transmitted by means of a telegram.

The rectification of a short-circuit or overload fault is described in detail in chapter 2.3 "Fitting and electrical connection".

Enabling short-circuit / overload feedback telegrams

A short-circuit or an overload condition is reported back via the 1-bit "Short-circuit / overload feedback" object existing for each output. The object can be enabled with the parameter "Short-circuit / overload feedback ?" on parameter page "Ax – Enabled functions (x = number of output 1...4).

- Set the parameter to "yes".

The short-circuit/overload feedback function is enabled and active. After identification of a short-circuit, the actuator transmits a feedback telegram "short-circuit / overload detected – 1" to the bus.

- ❗ In the event of a short-circuit/overload message, the actuator sets the switching status to "OFF" and the state of the brightness value to "0" and transmits these values to the bus, if enabled in the ETS.
- ❗ 7s after reactivation of the mains supply in the phase cut-off mode and 100 ms after reactivation of the mains supply in the phase cut-on mode, the actuator transmits a "no short-circuit / no overload – 0" message telegram to the bus, if the short-circuit / the overload has been rectified. Otherwise, a new short-circuit/overload message will be transmitted.
- ❗ After an ETS programming operation and after switching on of the bus voltage or of the mains supply, the actuator initializes the objects "short-circuit / overload feedback" of all outputs depending on their current state. It should be noted, however, that the "Delay after bus voltage return" parameterized in the ETS must first have elapsed before short-circuit / overload message telegrams can be transmitted to the bus.

Load failure feedback

The universal dimming actuator can monitor the current circuits of its load outputs independently of one another. The actuator detects mains supply failures (> 15 s) of an output or a circuit interruption when the load is on or off. The load failure detection can be enabled separately for each output in the ETS.

The following instructions describe how to enable a load failure detection feedback message and how such message is transmitted by means of a telegram.

The events causing a load failure and the rectification of these faults are described in detail in chapter 2.3 "Fitting and electrical connection".

Enabling load failure feedback telegrams

A load failure is reported back via the 1-bit "Load failure feedback" object existing for each output. The object can be enabled with the parameter "Load failure feedback ?" on parameter page "Ax – Enabled functions (x = number of output 1...4).

- Set the parameter to "yes".

The load failure feedback function is now enabled and active. After identification of a load failure, the actuator transmits a feedback telegram "load failure detected – 1" to the bus. A mains voltage failure at an output will always be identified as a load failure, if the mains voltage has failed during more than 15 seconds.

- ❗ In the event of a load failure, the actuator sets the switching status to "OFF" and the state of the brightness value to "0" and transmits these values to the bus, if enabled in the ETS.
- ❗ After an ETS programming operation and after switching on of the bus voltage or of the mains supply, the actuator initializes the objects "Load failure feedback" of all outputs depending on their actual state. It should be noted, however, that the "Delay after bus voltage return" parameterized in the ETS must first have elapsed before load failure message telegrams can be transmitted to the bus.
- ❗ If the load failure has been rectified, the actuator will send a "no load failure – 0" message telegram to the bus 15 seconds after the reactivation of the mains supply at the earliest. Otherwise, a new load failure message will be transmitted.
- ❗ On deactivation of the mains voltage supply of the dimming actuator (terminals "L" and "N" located beside the bus terminals) the dimming actuator will always – after the "Delay after bus voltage return" parameterized in the ETS – transmit a "no load failure – 0" message telegram to the bus provided the bus voltage is still present. This behaviour is especially important, if the mains voltage supply of the dimming actuator is shut off together with the mains voltage of a load circuit – for instance, when resetting a load failure.

Definition of brightness range

The brightness adjusting range of a dimming output can be limited by defining a basic brightness and an upper limit brightness. The parameters "Basic brightness" and "Maximum brightness" on parameter page "Ax – General" (x = number of output 1...4) are used to fix the lower and upper brightness thresholds which are not exceeded in any active state of operation of the output. The brightness of the connected lamps can thus be individually adapted to the subjective sensation of brightness of the human eye. A brightness level below the programmed basic brightness is not possible except by switching off.

In addition, the brightness to be adjusted after each switch-on via the "Switching" or the "Central function" object can be preset. This switch-on brightness is defined separately for each output with the parameter "Switch-on brightness" on parameter page "Ax – General" (x = number of output 1...4). The adjustable value lies between the basic brightness and the maximum brightness (cf. fig. 5).

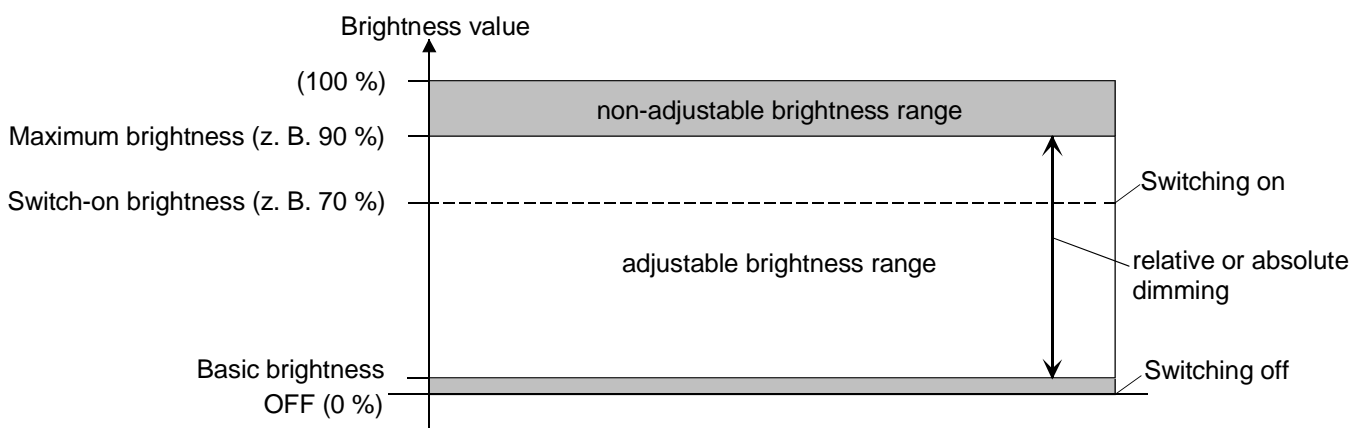

Fig. 5: Example of a brightness range with switch-on brightness for a dimming output

Presetting the basic brightness

The basic brightness can be set separately for each dimming output.

- Set the parameter "Basic brightness" on parameter page "Ax – General" (x = number of output 1...4) to the desired brightness level.

The adjusted brightness level is then equal to brightness value = "1" and is thus the lowest possible limit in all active states of operation of the output.

- ⓘ The basic brightness is always related to the absolute brightness value "1". The corresponding parameter defines the lowest setting required for the lamps used to reach this brightness value. The parameter should be adjusted in such a way that the lamp is just lit up in the lowest dimming position.

Presetting the maximum brightness

The maximum brightness can be set separately for each dimming output.

- Set the parameter "Maximum brightness" on parameter page "Ax – General" (x = number of output 1...4) to the desired brightness level.

The adjusted brightness cannot be exceeded in any of the active states of operation of the output.

- ❗ The ETS does NOT check all brightness settings of an output (e.g. switch-on brightness, scene values, etc.) when editing the maximum brightness. If individual brightness values in the configuration of an output exceed the parameterized maximum brightness, the actuator will adjust the output in operation to the maximum brightness value.
- ❗ If values exceeding the parameterized maximum brightness are received via the brightness value object, the dimming actuator adjusts the output concerned to the maximum brightness value.
- ❗ If the load rating of an output is enhanced by universal power boost units, the maximum brightness is to be reduced to a maximum of 90 %.

Presetting the switch-on brightness

The switch-on brightness can be set separately for each dimming output.

- Set the parameter "Switch-on brightness" on parameter page "Ax – General" (x = number of output 1...4) to "basic brightness" or to another brightness level (in %).

The output is adjusted to the preset brightness on reception of an ON telegram via the "Switching" communication object. The output is moreover adjusted to the parameterized switch-on brightness when a central telegram with the polarity "activated" is being received.

- As an alternative, the parameter "Switch-on brightness" can be set to "memory value (brightness prior to the last shut-off)"

After switch-on, the output is adjusted to the brightness value that was active and internally stored before the last shut-off (via the "Switching" or the "Central function" object. This memory value is stored non-permanently so that after a mains voltage failure in the actuator or after an ETS programming operation the brightness is set to maximum. A bus voltage failure alone is not sufficient to erase the memory value.

- ❗ If the parameterized switch-on brightness exceeds the parameterized maximum brightness, the dimming actuator adjusts the output concerned to the maximum brightness value as the new value when switching on.
- ❗ A memory value will be internally stored after a shut-off telegram even in those cases where the bus-controlled shut-off is overridden, for instance, by a disabling or by a forced-control function or by a manual control operation. In this case, the value stored as memory value is the internally tracked brightness value.
- ❗ If no soft-ON function is active, the actuator adopts the brightness value after switch-on by instantaneous approach. When a soft-ON function is active, the actuator approaches the switch-on brightness gradually with the speed programmed for the soft-ON function.
- ❗ When a dimming output is switched on by manual control it is always switched on with the maximum brightness. In this case, the "Switch-on brightness" parameter has no effect.

Behaviour in case of bus voltage failure, after bus or mains voltage return or after an ETS programming operation

The switching states or brightness values of the outputs after bus voltage failure, bus or mains voltage return or after an ETS programming operation can be preset separately.

Presetting the behaviour after an ETS programming operation

The parameter "Behaviour after ETS programming" exists separately for each output on the parameter page "Ax - General" (x = number of output 1...4). This parameter can be used to define the brightness behaviour of an output independent of the behaviour after bus or mains voltage return.

- Set the parameter to "no reaction".
After an ETS programming operation, the output shows no reaction and remains at the currently adjusted brightness level or off.
 - Set the parameter to "0 % (shut-off)".
The output is shut off after an ETS programming operation.
 - Set the parameter to "basic brightness" or to another brightness value (in %).
The output is adjusted to the preset brightness value. It must be ensured that the parameterized value does not exceed the preset maximum brightness.
- i** The behaviour specified in this parameter will be executed after each download of applications or parameters by the ETS. A simple download of the physical address alone or partial programming of only the group addresses has the effect that this parameter is disregarded and that the parameterized "Behaviour after bus voltage return" will be executed. The behaviour will moreover be executed only if bus and mains voltage supplies are connected to the device and activated.
- i** An ETS programming operation can also be performed without mains voltage. An ETS download does not require the mains voltage supply to be on.
- i** After each programming operation, the dimming actuator re-initializes itself briefly. Outputs programmed for the "universal" load type detect the load automatically. The automatic load detection procedure is characterized by the lamp flickering twice briefly in case of resistive loads and may last up to 10 seconds depending on power supply conditions.
- i** A switching state and a brightness value set after an ETS programming operation will be tracked in the feedback objects. Even after an ETS programming operation, actively transmitting feedback objects will not make their transmission unless the initialization is terminated and the "Delay after bus voltage return" has elapsed.
- i** If the parameter is set to "no reaction": After the programming operation the actuator will shut off briefly during the initialization phase. Thereafter, the brightness value that was active before will be adopted again.
- i** The manual mode, if active, will be terminated by an ETS programming operation.
- i** After an ETS programming operation, the disabling functions and the forced-control are always deactivated. The brightness values and forced-control objects stored during a bus voltage failure are deleted.

Presetting the behaviour in case of bus voltage failure

The parameter "Behaviour in case of bus voltage failure" exists separately for each output on parameter page "Ax - General" (x = number of output 1...4).

- Set the parameter to "no reaction".
In case of bus voltage failure, the output shows no reaction and remains at the currently adjusted brightness level or off.
 - Set the parameter to "0 % (shut-off)".
The output is shut off in case of bus voltage failure.
 - Set the parameter to "basic brightness" or to another brightness value (in %).
The output is adjusted to the preset brightness value. It must be ensured that the parameterized value does not exceed the preset maximum brightness.
- i** In case of mains voltage failure all outputs will be shut off. All telegrams received from the bus will be discarded. In case of mains voltage failure, switching status feedback telegrams (switching = "0", brightness = "0") are transmitted to the bus as long as the bus voltage is still present.
- i** Any active disabling or forced-control functions will be cancelled by a bus voltage failure and remain inactive until they are reactivated.
- i** During a bus or mains voltage failure, the current forced-control states are stored as well in case they must be tracked when the bus voltage returns (depending on the parameterization of the forced-control functions).
- i** In case of bus or mains voltage failure, the current brightness values of all outputs are permanently stored in the device so that these values can be readjusted after bus or mains voltage return, if so parameterized in the ETS. The data are stored before the reaction parameterized for the case of bus voltage failure occurs and only if one part of the supply voltage (mains or bus) is still present, or if the supply fails completely after the mains voltage has been available before without interruption for at least 20 seconds after the last reset (storage capacitors sufficiently charged for storage purposes). In all other cases, nothing will be stored (brightness values = "0")!

Storage takes place only once after part of the supply voltage has failed...

Example 1:

Bus voltage failure → storage → thereafter mains voltage failure → no further storage,

Example 2:

Mains voltage failure → storage → thereafter bus voltage failure → no further storage.

As the brightness values are stored only once during bus voltage failure, such values as are varied by manual control after bus voltage failure cannot be tracked.

Successfully stored brightness data are not lost during programming with the ETS.

Presetting the behaviour after bus or mains voltage return

The parameter "Behaviour after bus or mains voltage return" exists separately for each output on parameter page "Ax - General" (x = number of output 1...4).

- Set the parameter to "no reaction".
After bus/mains voltage return, the output shows no reaction and remains at the currently adjusted brightness level or off.
 - Set the parameter to "0 % (shut-off)".
The output is shut off on return of bus/mains voltage.
 - Set the parameter to "basic brightness" or to another brightness value (in %).
The output is adjusted to the preset brightness value. It must be ensured that the parameterized value does not exceed the preset maximum brightness.
 - Set the parameter to "brightness value before bus/mains voltage failure".
After bus/mains voltage return, the brightness value last adjusted before the bus/mains voltage failure and internally stored at the time of bus/mains voltage failure will be tracked.
 - Set the parameter to "activate staircase function".
The staircase function is activated after bus/mains voltage return independent of the "Switching" object. For this setting it is indispensable that the Staircase function has been programmed and enabled for the output. If the Staircase function has not been enabled, this setting will produce no reaction after return of bus/mains voltage.
-
- i** For all settings: On activation of the bus voltage, the brightness value is set to "0 %", if – at the time of bus voltage return – there was no mains voltage (at the load output or at the "L" and "N" terminals of the actuator).
 - i** Setting "brightness value as before bus/mains voltage failure": Programming of an application or of parameters with ETS resets the stored switching state to "off – 0".
 - i** Setting "no reaction": On return of bus voltage (e.g. bus reset with the mains voltage supply continuously on), the corresponding dimming output shows no reaction and remains at the brightness level last adjusted.
When the mains voltage supply is switched on (bus voltage being on or off), the dimming actuator sets the corresponding outputs to brightness level "0".
 - i** After every activation of the mains voltage, the dimming actuator re-initializes itself briefly. Outputs programmed for the "universal" load type detect the load automatically. The automatic load detection procedure is characterized by the lamp flickering twice briefly in case of resistive loads and may last up to 10 seconds depending on power supply conditions.
 - i** A switching state and a brightness value adjusted after bus/mains voltage return is tracked in the feedback objects. Actively transmitting feedback objects will not make their transmission after bus or mains voltage return unless the initialization of the actuator is terminated and – if programmed – the "Delay after bus voltage return" has elapsed.
 - i** With Forced-control position as additional function: The communication object of the forced-control function can be initialized separately after bus voltage return. This has an effect on the reaction of the output when the Forced-control position is activated on bus voltage return. The parameterized "Behaviour after bus or mains voltage return" will only be executed, if no Forced-control position is activated after bus voltage return.
 - i** With disabling function as additional function: Active disabling functions are always inactive after bus or mains voltage return.
 - i** An active manual control is terminated on return of bus voltage. In case of mains failure, no manual control is possible.

Feedback for switching status and brightness value

The dimming actuator can track the current switching state and brightness value of a dimming output via separate feedback objects and also transmit them to the bus, if the bus voltage is on. The following feedback objects can be enabled separately for each dimming output...

- switching status feedback (1 bit),
- brightness value feedback (1 byte)

The actuator computes the value of the feedback objects for switching or dimming operation. Even if an output is activated by manual control or by the scene function, the actuator tracks the switching state or the brightness value and updates the feedback objects.

The switching status feedback object is updated after the following events...

- immediately after activation of an output (only after an ON-delay - if applicable - has elapsed and at the beginning of a soft-ON dimming procedure / also with a Staircase function),
- after deactivation of an output (only after an OFF-delay - if applicable - has elapsed and at the beginning of a soft-OFF dimming procedure / also with a Staircase function),
- immediately after shut-off by the automatic shut-off function,
- at the beginning of a dimming cycle when an output is activated (relative increase of brightness or brightness value = 1...100 %),
- at the end of a dimming cycle when an output is deactivated (brightness value = 0 %)
- only when the switching state changes (i.e. not for dimming cycles without change of the switching state, e.g. from 10 % brightness to 50 % brightness),
- during updates of the switching state from "ON" to "ON", if the output was already on,
- during updates of the switching state from "OFF" to "OFF", if the output was already off,
- always at the beginning or at the end of a disabling or forced-control function (only if the switching state is changed thereby),
- always on return of bus/mains voltage, in case of mains voltage failure ("OFF") or at the end of an ETS programming operation (if applicable, also with a time delay and after automatic load detection).

The brightness feedback object is updated after the following events...

- at the end of a relative (4-bit) or absolute (1-byte) dimming procedure,
- after activation of an output when the switch-on brightness has been adjusted (only after an ON-delay - if applicable - has elapsed and at the end of a soft-ON dimming procedure / also with a Staircase function),
- after deactivation of an output (only after an OFF-delay - if applicable - has elapsed and at the beginning of a soft-OFF dimming procedure / also with a Staircase function),
- immediately after shut-off by the automatic shut-off function,
- only when the brightness value changes (if a brightness value preset by relative or absolute dimming from an external source exceeds the maximum brightness, the actuator will NOT update a brightness value feedback with regard to maximum brightness)
- always at the beginning or at the end of a disabling or forced-control function (only if the brightness value is changed thereby),
- always on return of bus/mains voltage, in case of mains voltage failure ("0") or at the end of an ETS programming operation (if applicable, also with a time delay and after automatic load detection).

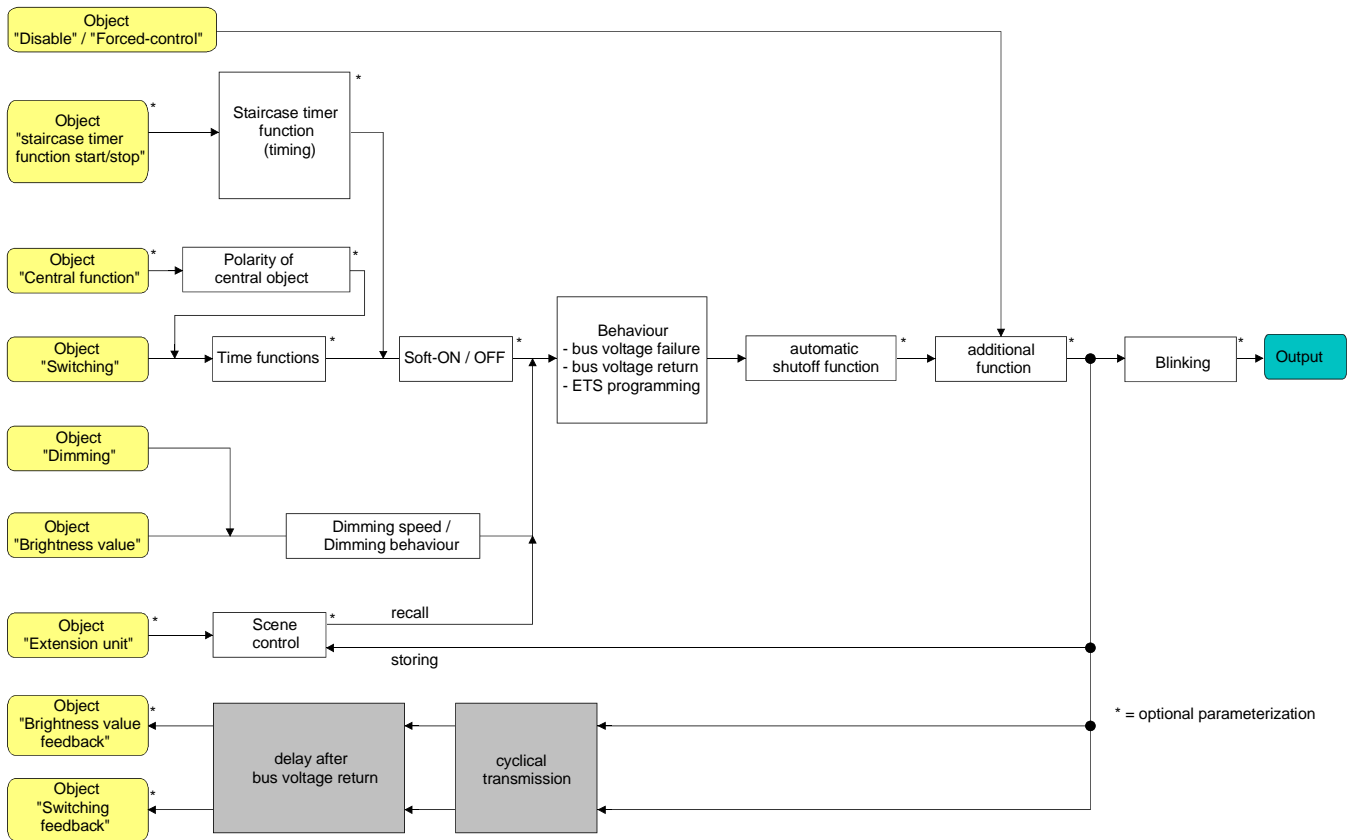

Fig. 6: Functional feedback diagram

i With disabling function as additional function: A 'blinking' output will always be reported back as "switched on" and with switch-on brightness. Switching status feedback telegrams will also be transmitted for disabled outputs, for instance, if these outputs are readjusted by manual control.

Activating the switching status feedback function

The switching status feedback can be used as an active message object or as a passive status object. As an active message object, the switching status feedback information is transmitted directly to the bus after each update. As a passive status object, there is no telegram transmission in case of an update. In this case, the object value must be read out. The ETS automatically sets the object communication flags required for proper functioning.

The parameter "Switching status feedback ?" exists separately for each output on parameter page "Ax – Feedbacks" (x = number of output 1...4).

The feedbacks must be enabled on parameter page "Ax - Enabled functions".

- Set the parameter to "feedback object is active message object".
The "Switching status feedback" object is enabled. The switching status is transmitted as soon as the status is updated. After bus/mains voltage return or after an ETS programming operation, the feedback message is transmitted automatically.
- Set the parameter to "feedback object is passive status object".
The "Switching feedback" object is enabled. The switching status will be transmitted in response only when the feedback object is read out from by the bus. After bus/mains voltage return or after an ETS programming operation there will no automatic transmission of the feedback telegram.
- Set the parameter to "no feedback".
The switching status feedback is deactivated.

i Feedback of the current switching status via the "Switching" object is not possible.

Presetting the switching status feedback in case of bus/mains voltage return or after an ETS programming operation

If used as active message object, the state of the switching status feedback is transmitted to the bus after bus or mains voltage return or after an ETS programming operation. In these cases, the feedback telegram can be time-delayed with the delay being preset globally for all outputs together (cf. "Delay after bus/mains voltage return").

- Set the parameter "Time delay for feedback telegram after bus voltage return ?" on parameter page "Ax - Feedbacks" (x = number of output 1...4) to "yes".
The switching status feedback telegram will be transmitted with a delay after bus or mains voltage return or after an ETS programming operation. No feedback telegram is transmitted during a running delay, even if the switching state changes during the delay.
- Set the parameter "Time delay for feedback telegram after bus voltage return ?" on parameter page "Ax - Feedbacks" (x = number of output 1...4) to "no".
The switching status feedback telegram will be transmitted immediately after bus or mains voltage return or after an ETS programming operation.

i On return of mains voltage or after an ETS programming operation, the switching status feedback telegram is always transmitted with a basic delay of a few seconds (initialization of the dimming actuator or automatic load type detection). The basic delay is added to the "Delay after bus/mains voltage return" parameterized in the ETS, if such delay is activated.

Presetting cyclical transmission for switching status feedback telegrams

In addition to being transmitted in case of an update, the switching status feedback telegram can also be transmitted cyclically via the active message object.

- Set the parameter "Cyclical transmission of feedback telegram ?" on parameter page "Ax - Feedbacks" (x = number of output 1...4) to "yes".
Cyclical transmission is now activated.
 - Set the parameter "Cyclical transmission of feedback telegram ?" on parameter page "Ax - Feedbacks" (x = number of output 1...4) to "no".
Cyclical transmission is deactivated which means that a feedback telegram is transmitted to the bus only when a switching status is updated.
- i** The cycle time is defined centrally for all outputs on parameter page "Time settings"
- i** During an active delay after bus/mains voltage return no feedback telegram will be transmitted even if a switching state changes.

Activating the brightness feedback

The brightness value feedback can be used as an active message object or as a passive status object. As an active message object, the brightness value feedback is transmitted directly to the bus after each update. As a passive status object, there is no telegram transmission in case of an update. In this case, the object value must be read out. The ETS automatically sets the object communication flags required for proper functioning.

The parameter "Brightness value feedback ?" exists separately for each output on parameter page "Ax - Feedbacks" (x = number of output 1...4).

The feedbacks must be enabled on parameter page "Ax - Enabled functions".

- Set the parameter to "feedback object is active message object".
The "Brightness value feedback" object is enabled. The brightness value is transmitted as soon as it is updated. After bus/mains voltage return or after an ETS programming operation, the feedback message is transmitted automatically.
 - Set the parameter to "feedback object is passive status object".
The "Brightness value feedback" object is enabled. The brightness value will be transmitted in response only when the feedback object is read out from by the bus. After bus/mains voltage return or after an ETS programming operation there will no automatic transmission of the feedback telegram.
 - Set the parameter to "no feedback".
The brightness value feedback is deactivated.
- i** Feedback of the current brightness value via the "Brightness value" object is not possible even if the T flag is set.

Presetting the brightness value feedback in case of bus/mains voltage return or after an ETS programming operation

If used as active message object, the brightness value feedback status is transmitted to the bus after bus or mains voltage return or after an ETS programming operation. In these cases, the feedback telegram can be time-delayed with the delay being preset globally for all outputs together (cf. "Delay after bus/mains voltage return").

- Set the parameter "Time delay for feedback telegram after bus voltage return?" on parameter page "Ax - Feedbacks" (x = number of output 1...4) to "yes".
The brightness value feedback telegram will be transmitted with a delay after bus or mains voltage return or after an ETS programming operation. No feedback telegram is transmitted during a running delay, even if the brightness value changes during the delay.
 - Set the parameter "Time delay for feedback telegram after bus voltage return?" on parameter page "Ax - Feedbacks" (x = number of output 1...4) to "no".
The brightness value feedback telegram will be transmitted immediately after bus or mains voltage return or after an ETS programming operation.
- i** On return of mains voltage or after an ETS programming operation, the switching status feedback telegram is always transmitted with a basic delay of a few seconds (initialization of the dimming actuator or automatic load type detection). The basic delay is added to the "Delay after bus/mains voltage return" parameterized in the ETS, if such delay is activated.

Presetting cyclical transmission for brightness value feedback telegrams

In addition to being transmitted in case of an update, the brightness value feedback telegram can also be transmitted cyclically via the active message object.

- Set the parameter "Cyclical transmission of feedback telegram ?" on parameter page "Ax - Feedbacks" (x = number of output 1...4) to "yes".
Cyclical transmission is now activated.
 - Set the parameter "Cyclical transmission of feedback telegram ?" on parameter page "Ax - Feedbacks" (x = number of output 1...4) to "no".
Cyclical transmission is deactivated which means that the feedback telegram is transmitted to the bus only when a brightness value is updated.
- i** The cycle time is defined centrally for all outputs on parameter page "Time settings"
- i** During an active delay after bus/mains voltage return no feedback telegram will be transmitted even if a brightness value changes.

Time delays

Up to two time functions can be preset independently for each output. The time functions act solely on the communication objects "Switching" or "Central function" (if a central has been activated for the output in question) and delay the received object value as a function of telegram polarity (cf. fig. 7).

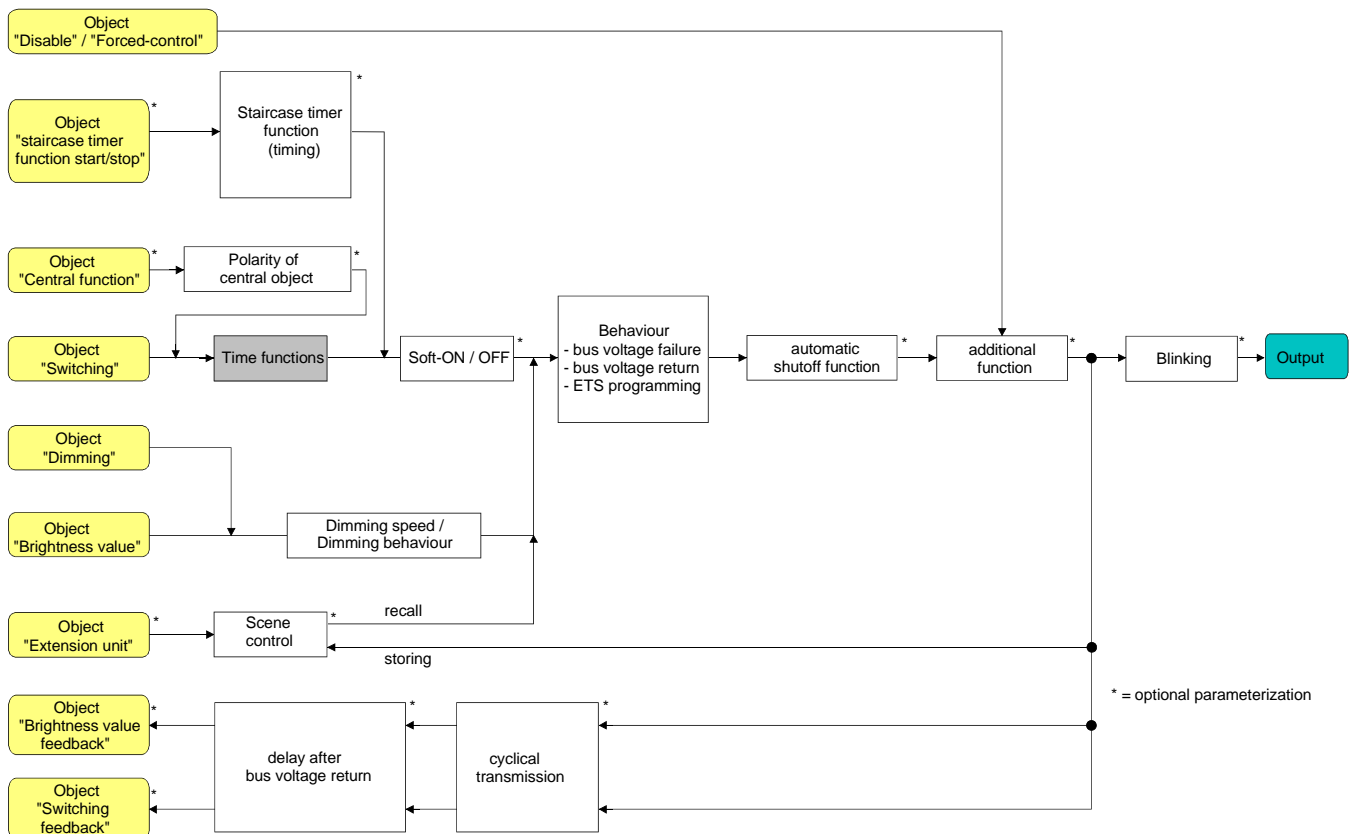

Fig. 7: Functional diagram of the time delays

Activating an ON-delay

The load failure detection can be enabled separately for each output in the ETS.

The time delays must be enabled on parameter page "Ax - Enabled functions".

- Set the parameter "Selection of time delay" on parameter page "Ax – Time delays" to "ON-delay" or to "ON-delay and OFF delay". Parameterize the desired ON-delay.

The ON-delay is now enabled. After reception of an ON-telegram via the "Switching" object, the parameterized time is started. A subsequent ON-telegram retriggers the time only if the parameter "ON-delay retriggerable ?" has been set to "yes". An OFF-telegram received during the ON-delay ends the delay and sets the switching status to "OFF".

Activating an OFF-delay

The OFF-delay can be enabled in the ETS separately for each output.

The time delays must be enabled on parameter page "Ax - Enabled functions".

- Set the parameter "Selection of time delay" on parameter page "Ax – Time delays" (x = number of output 1...4) to "OFF-delay" or to "ON-delay and OFF delay". Parameterize the desired OFF-delay. The OFF-delay is now enabled. After reception of an OFF telegram via the "Switching" object, the parameterized time is started. A subsequent OFF-telegram retriggers the time only if the parameter "OFF-delay retriggerable ?" has been set to "yes". An ON-telegram received during the OFF-delay ends the delay and sets the switching status to "ON".
- ❗ Feedback: If a time delay has been preset and if the switching state is changed via the "Switching" object, the time delay must have elapsed before feedback telegrams will be transmitted. Updates of the object from "ON" to "ON" or from "OFF" to "OFF" by retriggering during a running time delay has no influence on the switching status feedback.
- ❗ At the end of a disabling or forced-control function, the brightness value received during or set before the function can be tracked. Residual times of time functions are tracked, if they have not completely elapsed at the time the disabling or forced-control functions are disabled.
- ❗ The time delays have no influence on the Staircase functions, if these are enabled.
- ❗ A time delay in progress will be completely terminated by a reset of the actuator (bus/mains voltage failure or ETS programming operation).

Soft-ON/OFF function

The 'soft functions' allow to slow down the activation and deactivation of a dimming output, when a switching command is being received via the communication objects "Switching" or "Central function". When the soft-ON function is activated, the brightness is increased up to the parameterized switch-on brightness. This is also the case when the output is already active with a brightness value corresponding to a lower switch-on brightness. When the soft-OFF function is activated, the brightness is likewise reduced down to 0 % when an OFF-telegram is being received.

The brightness variation speeds can be parameterized in the ETS separately for the soft-ON as well as for the soft-OFF function. The value parameterized is the relative dimming step time between 2 of 255 dimming steps.

The soft-ON or the soft-OFF functions cannot be retriggered by the reception of further switching telegrams with the same switching status. The 'soft functions' can be configured and activated in the ETS separately of one another.

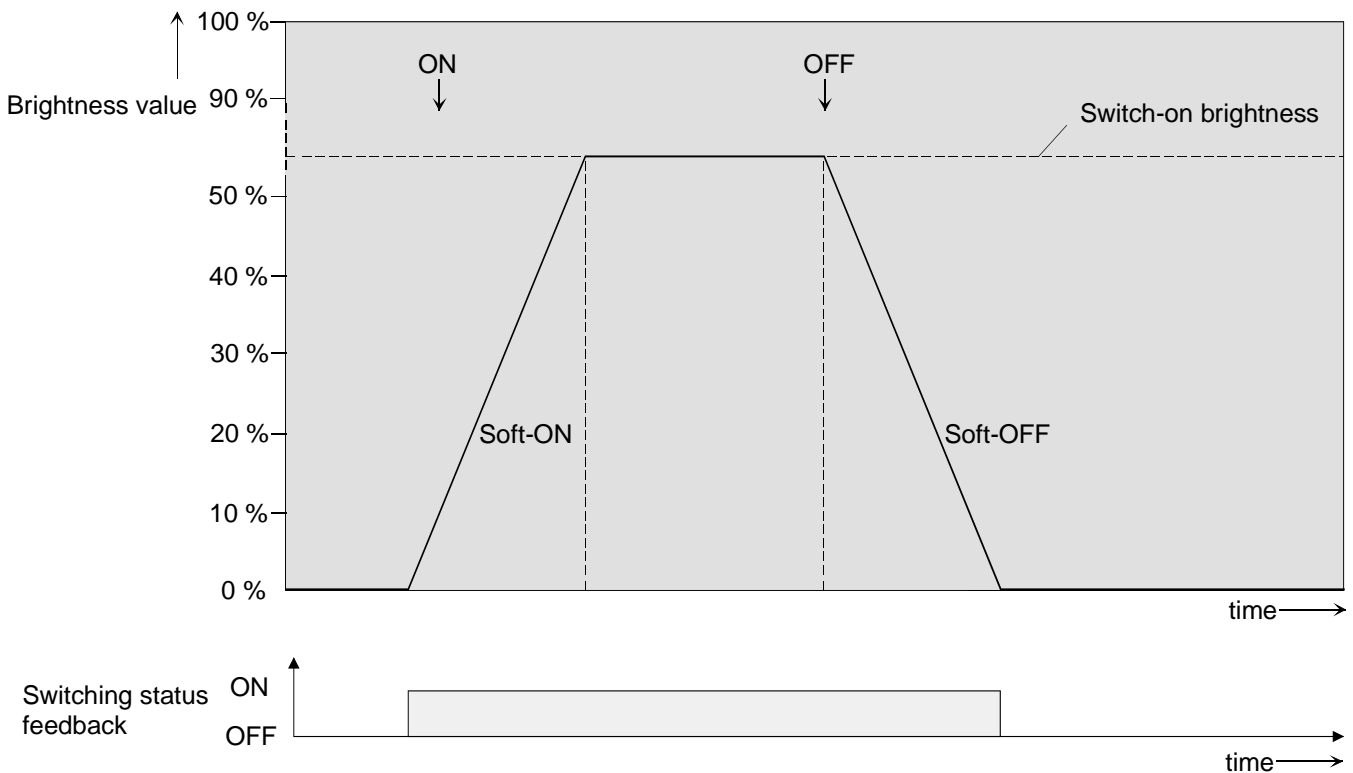

Fig. 8: Dimming behaviour of the soft-ON/OFF functions
(example)

Figure 9 shows the functional diagram of the 'soft functions'. The 'soft functions' also have an effect on the switching pulse edges of the Staircase function.

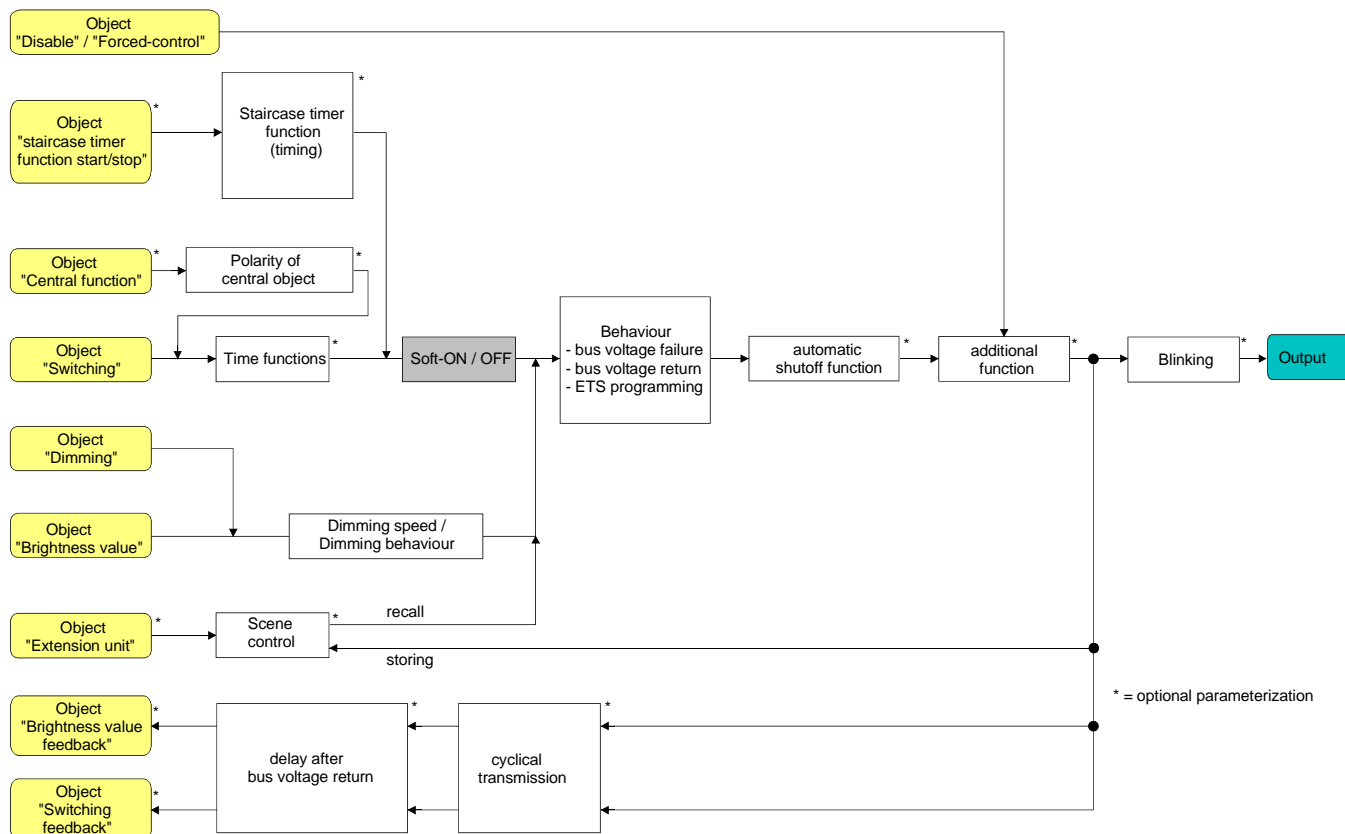

Fig. 9: functional diagram of the 'soft functions'

i Depending on the parameterization of the disabling function, an output disabled via the bus can also be made to blink. The ON and OFF blinking sequence does not make use of the SOFT functions.

Enabling and presetting the soft-ON function

The soft-ON function can be enabled separately for each output in the ETS.

The switch-on/switch-off behaviour must be enabled on parameter page "Ax – Enabled functions (x = number of output 1...4).

- Set the parameter "Soft-ON function ?" on parameter page "Ax – Switch-on/switch-off behaviour" to "yes".

The soft-ON function is then enabled. The parameter for the dimming step time (time between 2 of 255 dimming steps) of the soft-ON function is then visible.

- Set the parameter "Time for dimming step soft-ON" to the required dimming step time.

Enabling and presetting the soft-OFF function

The soft-OFF function can be enabled separately for each output in the ETS.

The switch-on/switch-off behaviour must be enabled on parameter page "Ax – Enabled functions (x = number of output 1...4).

- Set the parameter "Soft-OFF function ?" on parameter page "Ax – Switch-on/switch-off behaviour" to "yes".

The soft-OFF function is then enabled. The parameter for the dimming step time (time between 2 of 255 dimming steps) of the soft-OFF function is then visible.

- Set the parameter "Time for dimming step soft-OFF" to the required dimming step time.

Automatic shut-off

The shut-off function permits shutting off a dimming output automatically if a dimming value has been set by direct or gradual approach and if this new brightness value is below a shut-off brightness level fixed in the ETS. As an option, a delay before shut-off can be programmed (cf. fig. 10).

The shut-off function is activated only after a constant brightness level has been reached, i.e. after an accomplished dimming procedure. A new dimming procedure ending equally below the shut-off brightness restarts a time delay, if parameterized. Similarly, the shut-off function will be interrupted when the shut-off brightness level is exceeded in a dimming procedure.

The use of the automatic shut-off function permits, for instance, setting the lighting by relative dimming not only to the basic brightness, but also shutting it off. Another application consists in the time-controlled 'good-night shut-off' of a dimmed lamp in a child's bedroom.

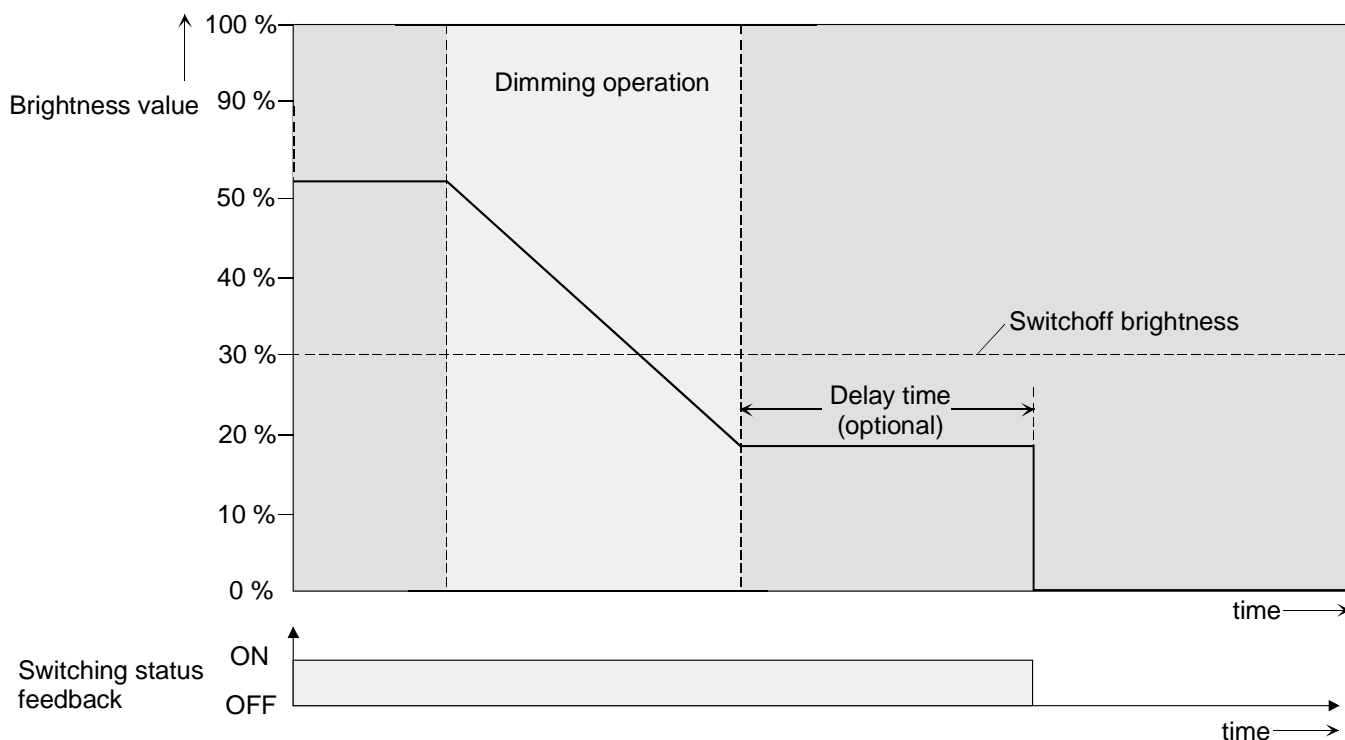

Fig. 10: Dimming and switching behaviour of the automatic shut-off function

- i** Shutting off is basically performed instantaneously, i.e. without soft-OFF function.
- i** The shut-off brightness can be selected within the dimmable brightness range between basic and maximum brightness. The shut-off function is permanently active if the shut-off brightness is programmed for maximum brightness and if the actual brightness is at any level below the maximum brightness.
- i** The feedback objects for switching state and brightness value are updated by the automatic shut-off function after the shut-off.

The automatic shut-off function can be activated on the one hand by means of a dimming cycle initiated via the 4-bit ("Dimming") or the 1-byte ("Brightness value") communication objects. On the other hand, the automatic shut-off is activated also in that case where an output is switched on (switch-on brightness < shut-off brightness) or where a brightness level is set by an ETS programming operation or by bus voltage failure or by bus/mains voltage return. The automatic shut-off function can also be activated in case of a scene recall.

It should be noted that the disabling function or the forced-control function overrides the shut-off function (cf. fig. 11). When the shut-off function is overridden, the actuator stops the evaluation of the shut-off brightness.

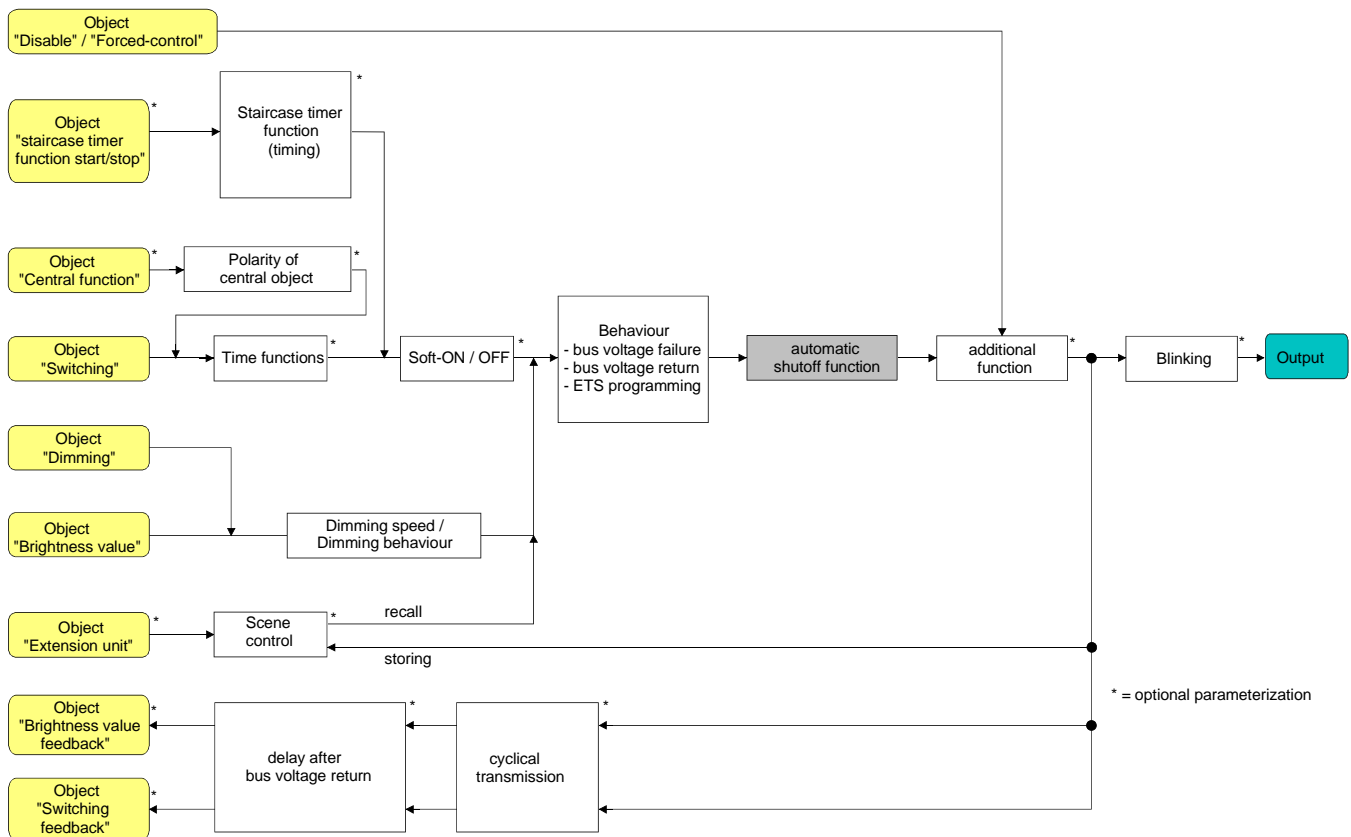

Fig. 11: Functional diagram of the automatic shut-off function

Enabling the automatic shut-off function

The automatic shut-off function can be enabled separately for each output in the ETS.

The switch-on/switch-off behaviour must be enabled on parameter page "Ax – Enabled functions (x = number of output 1...4).

- Set the parameter "Automatic shutoff when falling below a specified brightness ?" on parameter page "Ax – Switch-on/switch-off behaviour" to "yes".

The automatic shut-off function is enabled and activated. Further parameters are displayed.

Presetting the shut-off brightness

If the shut-off function is to be used it is necessary to define the shut-off brightness. The shut-off brightness is preset in the ETS separately for each output.

The shut-off function must have been enabled.

- Set the parameter "Shutoff when brightness value smaller" on parameter page "Ax – Switch-on/switch-off behaviour" to the desired brightness level.

If the brightness falls during dimming below the parameterized shut-off brightness level and is then constant, the output concerned shuts off or alternatively starts the delay before shut-off.

- ❗ It must be ensured that the parameterized shut-off brightness value does not exceed the preset maximum brightness level.
- ❗ When the Staircase function with pre-warning is used: The reduced brightness of the pre-warning launches the shut-off function when reaching or when falling below the shut-off brightness level.

Presetting the shut-off function delay

Before the shut-off function shuts off automatically when the brightness falls below the shut-off brightness at the end of a dimming cycle, a time delay can be activated. If desired, the time delay can be enabled separately for each output.

The shut-off function must have been enabled.

- Set the parameter "Delay until shutoff" on parameter page "Ax – Switch-on/switch-off behaviour" to the desired duration of the delay.

If a dimming cycle causes the brightness to fall below the parameterized shut-off brightness level and then to remain at a constant level, the actuator triggers the delay. The output concerned shuts off definitely when the delay has ended. The delay can be retriggered by subsequent dimming cycles.

Staircase timer function

The separately programmable staircase timer function can be used for implementing a time-controlled staircase lighting function or functionally similar applications. The Staircase function must have been enabled on parameter page "Ax – Enabled functions" (x = number of output 1...4) before the required communication objects and parameters become available.

The staircase function is controlled by means of the "Staircase function start / stop" communication object and is independent of the "Switching" object of an output (cf. fig. 12). This feature permits 'parallel operation' of time and normal control, with always the last command being executed. A telegram to the "Switching" object when the staircase function is active ends the staircase time prematurely and sets the output to the switching state corresponding to the object value received (time delays are taken into account). Similarly, the switching state of the "Switching" object can be overridden by a staircase function.

In combination with a disabling function, a time-independent permanent lighting function can also be realized. The staircase function can be enlarged by a additional function. One possibility consists in the activation of a time extension. The "time extension" permits retriggering an activated staircase time n times via the object "Staircase function start / stop". As an alternative, "time definition via bus" can be selected. With this additional function, the parameterized staircase time can be multiplied with a factor received from the bus and thus dynamically adapted. The staircase function can moreover be enlarged by a separate ON-delay and by a pre-warning function. During the pre-warning, the brightness of a dimming output can be reduced. In acc. with DIN 18015-2, the pre-warning function is designed to warn persons in the staircase that the lights will go out shortly.

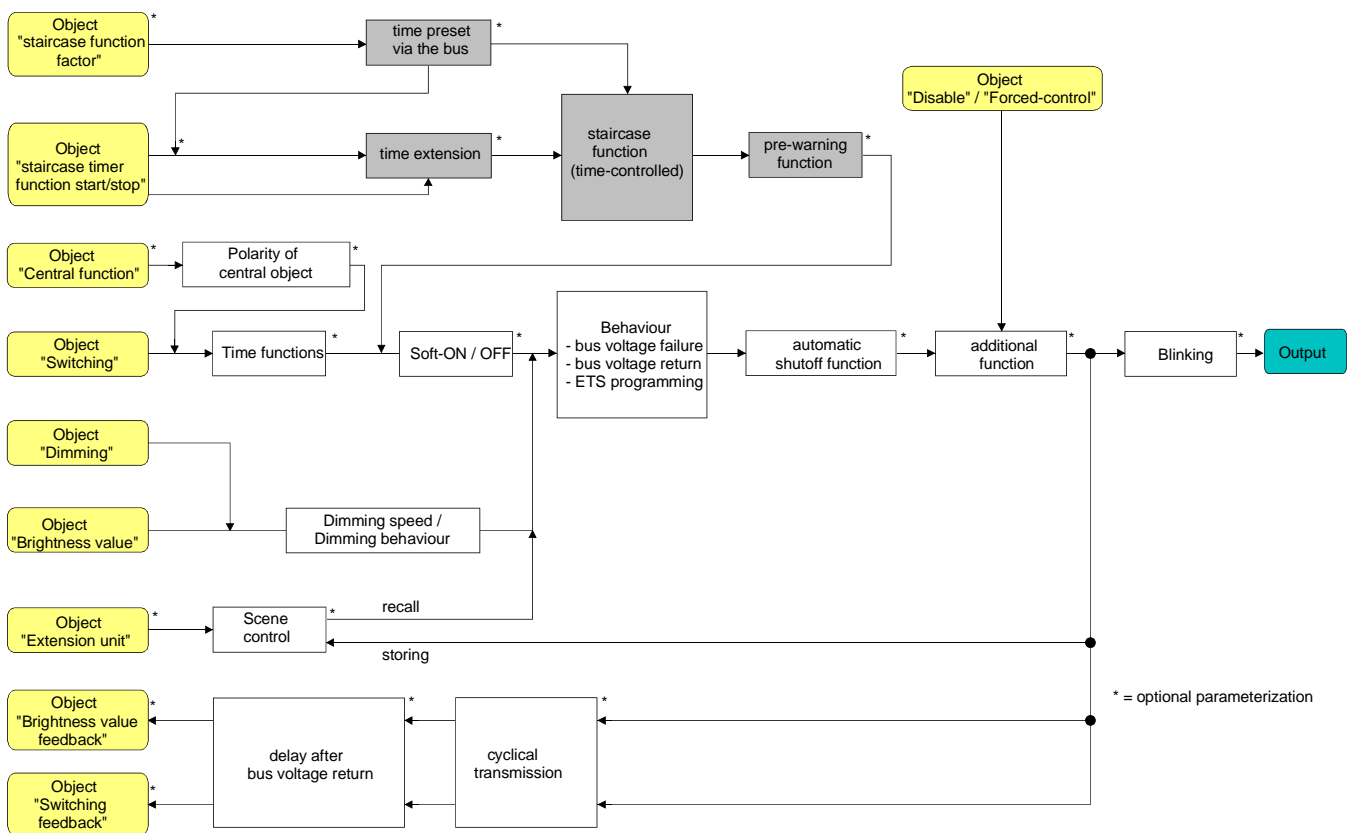

Fig. 12: Functional diagram of the Staircase function

Defining the switch-on behaviour of the staircase function

An ON-telegram to the "Staircase function start / stop" activates the staircase lighting time (T_{ON}) the duration of which is defined by the parameter "Staircase lighting time". The output is activated with the switch-on brightness. At the end of the staircase lighting time, the output switches off or optionally activates the pre-warning time ($T_{pre-warn}$) of the pre-warning function (cf. Presetting the pre-warning function of the Staircase function). With the pre-warning function, the Staircase function has the switch-on behaviour as shown in fig. 13.

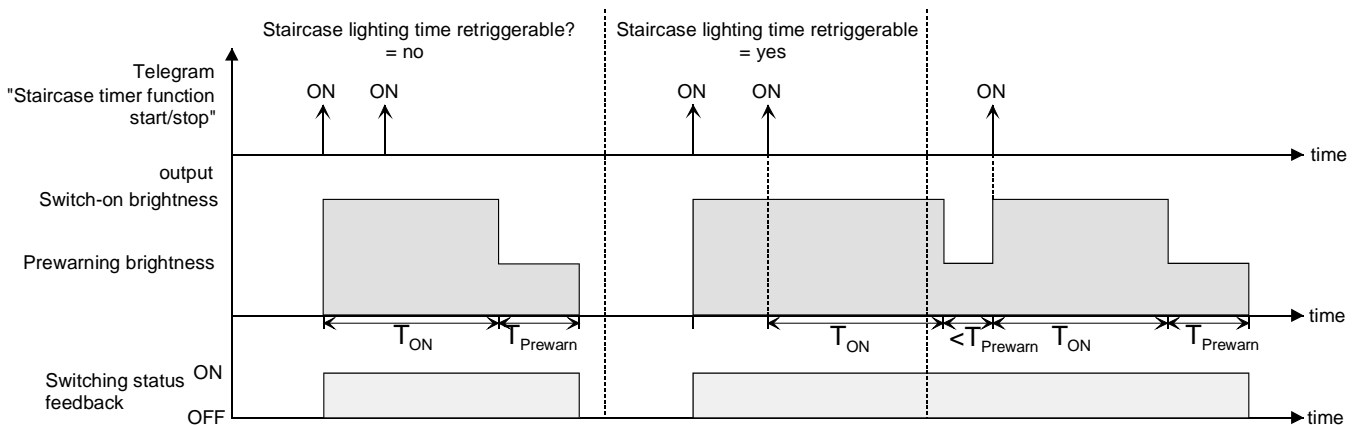

Fig. 13: Switch-on behaviour of the staircase function without 'soft functions'

Additionally, the switch-on behaviour of the actuator can be influenced by the 'soft functions'. With a soft-ON and a soft-OFF function, the Staircase function has the switch-on behaviour as shown in fig. 14.

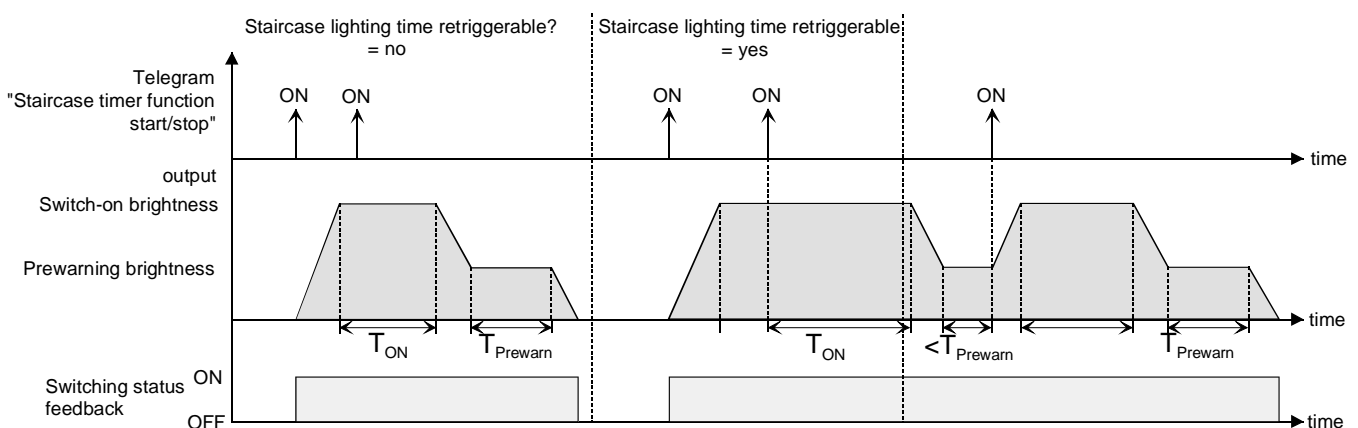

Fig. 14: Switch-on behaviour of the staircase function with 'soft functions'
(example: with minimum brightness = 0 %)

- Set the parameter "Staircase function ?" on parameter page "Ax - Enabled functions" (x = number of output 1...4) to "enabled".
The Staircase function is enabled. The other parameters on parameter page "Ax – Staircase function" are now visible
 - Define the required ON-time of the staircase timer in the "Staircase time" parameter on parameter page "Ax – Staircase function".
 - Set the parameter "Staircase time retriggerable ?" on parameter page "Ax – Staircase function" to "yes".
Every ON-telegram received during the ON-phase of the staircase lighting time retriggers the staircase time completely.
 - The parameter "Staircase time retriggerable ?" is alternatively set to "no".
ON-telegrams received during the ON-phase of the staircase time will be rejected. The staircase lighting time will not be retriggered.
- i** An ON-telegram received during the pre-warning time always retriggers the staircase time independent of the "Staircase time retriggerable ?" parameter.

Defining the switch-off behaviour of the staircase function

In a staircase function, the reaction to an OFF-telegram to the "Staircase function start / stop" object can also be parameterized. Without reception of an OFF-telegram, an output may shut off after the pre-warning time has elapsed. With the pre-warning function, the staircase function has the shut-off behaviour shown in fig. 15.

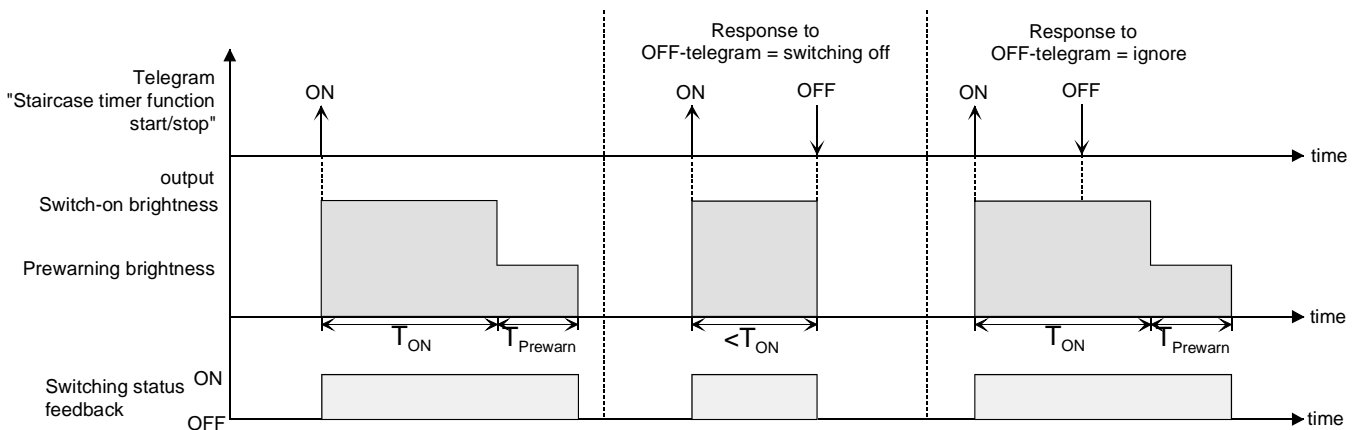

Fig. 15: Shut-off behaviour of the staircase function without 'soft functions'

Additionally, the shut-off behaviour of the actuator can be influenced by the 'soft functions'. With a soft-ON and a soft-OFF function, the staircase function has the shut-off behaviour shown in fig. 16.

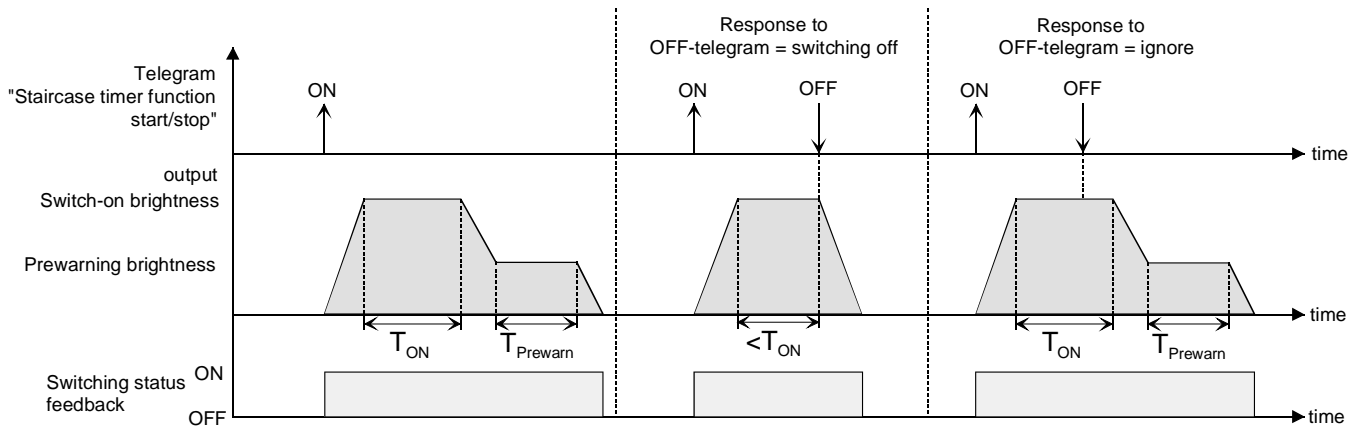

Fig. 16: Shut-off behaviour of the staircase function with 'soft functions'
(example: with minimum brightness = 0 %)

The parameter "Response to OFF-telegram" on parameter page "Ax – Staircase function" (x = number of output 1...4) defines whether the staircase time (T_{ON}) of the Staircase function can be stopped prematurely.

The staircase function must be enabled.

- Set the parameter "Response to OFF-telegram" to "switch-off".

The output concerned shuts off immediately when an OFF-telegram is received via the object "Staircase function start / stop" during the ON-phase of the staircase time. If the staircase time is stopped prematurely by such a telegram, there is no pre-warning, i.e. the pre-warning time is not started.

Premature shut-off is also possible during a dimming cycle, a 'soft function' or a pre-warning.

- Set the parameter "Response to OFF-telegram" to "ignore".

OFF-telegrams received during the ON-phase of the staircase time via the "Staircase function start / stop" object will be rejected. The staircase time will be executed completely, if applicable with a pre-warning.

Presetting the pre-warning function of the staircase function

As per DIN 18015-2, the pre-warning function is designed to warn persons still in the staircase that the lights will go out shortly. For pre-warning purposes, a dimming output can be preset to a pre-warning brightness before the output shuts off definitely. As a rule, the pre-warning brightness level is lower than that of the switch-on brightness. The pre-warning time ($T_{\text{pre-warn}}$) and the pre-warning brightness can be parameterized separately (cf. fig. 17).

The pre-warning time is added to the staircase time (T_{ON}). The pre-warning time has an influence on the feedback object values so that switching status "OFF" and value "0" are tracked in the feedback objects only after the pre-warning time has elapsed.

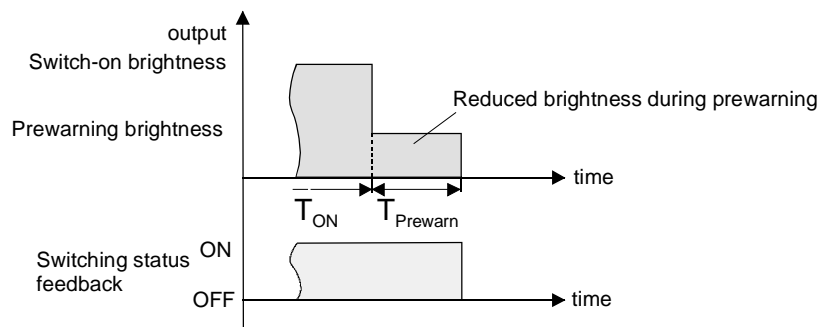

Fig. 17: The pre-warning function of the Staircase function without soft-OFF function

Additionally, the pre-warning function can also be enlarged by the soft-OFF function. With a soft-OFF function, the staircase function has the shut-off behaviour after pre-warning shown in fig. 18.

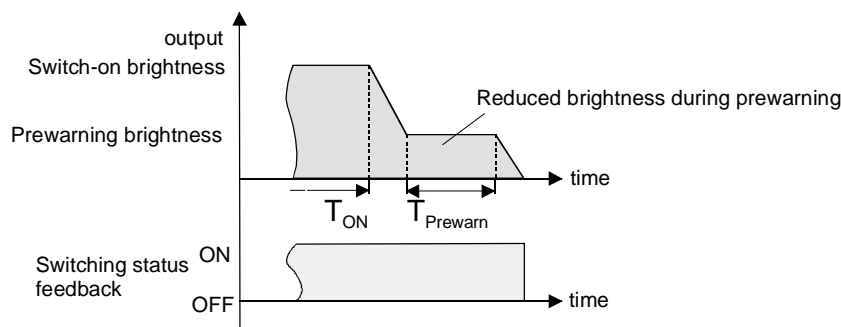

Fig. 18: The pre-warning function of the Staircase function with soft-OFF function
(example: with minimum brightness = 0 %)

i The pre-warning brightness must not necessarily be lower than the switch-on brightness. Basically, the pre-warning brightness can be parameterized with a value between basic and maximum brightness.

The staircase function must be enabled.

- Set the parameter "Activate pre-warning time ?" on parameter page "Ax – Staircase function" (x = number of output 1...4) to "yes".

The pre-warning function is now enabled. The desired pre-warning time ($T_{\text{pre-warn}}$) can then be preset.

- Set the parameter "Reduced brightness during pre-warning time (1...100 %)" on parameter page "Ax – Staircase function" to the desired brightness.

Within the pre-warning time, the output is set to the parameterized brightness value.

- ⓘ The parameterized value of the reduced brightness must be less than or equal to the maximum brightness value!
- ⓘ With an ON-telegram to the "Staircase function start / stop" object during an active pre-warning function, the pre-warning time is stopped and the staircase time always restarted (independent of the "Staircase time retriggerable ?" parameter). The parameter "Response to OFF-telegram" is also evaluated during the pre-warning time so that an active pre-warning can be stopped prematurely by shutting off.
- ⓘ When the automatic shut-off function is being used: The reduced brightness of the pre-warning launches the shut-off function when reaching or when falling below the shut-off brightness level.

Presetting the "Time extension" as additional function to the staircase function

With the time extension function, the staircase time can be retriggered several times (i.e. extended) via the "Staircase function start / stop" object. The duration of the extension is defined by repeated operation of a control device (several ON-telegrams in succession). The parameterized staircase time can thus be extended by the parameterized factor (max. 5-fold). The extension is then always automatically added to the end of a simple staircase time (T_{ON}) (cf. fig. 19).

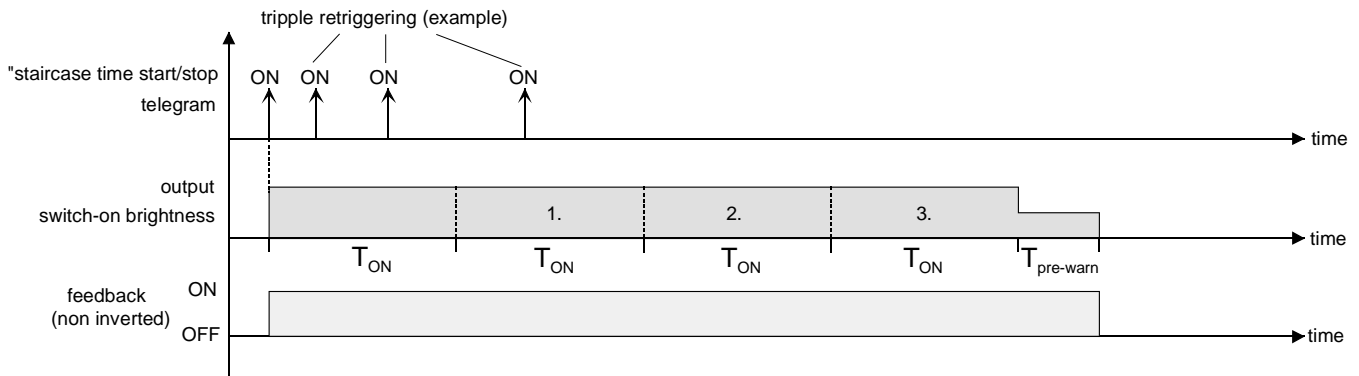

Fig. 19: Time extension for staircase function

With this function, the lighting time in a staircase can be extended (e.g. by a person after shopping) by a defined length without having to retrigger the lighting every time the lighting shuts off.

The staircase function must have been enabled on parameter page "Ax – Enabled functions".

- Set the parameter "Supplementary function for staircase function" on parameter page "Ax – Staircase function" to "Time extension" and select the desired factor in the "Maximum time extension" parameter.

On reception of an ON-telegram to the "Staircase function start / stop" object, the staircase time is retriggered at the end of the ON-time as often as determined by the number of telegrams received, however, only as often as permitted by the parameterized factor.

Thus, the setting "3-fold" means that the started staircase time can be automatically retriggered at maximum three more times after elapsing. This means that the time corresponds to 4 times the basic time (cf. fig. 19).

- ❗ Triggering of an extension can occur during the whole staircase time (T_{ON}). There is no restriction as to the time between two telegrams triggering an extension.
Time extension telegrams are evaluated only during the staircase time. An ON-telegram during the pre-warning time triggers the staircase time like in a new start making another time extension possible.
- ❗ If a time extension has been parameterized as a additional function, the parameter "Staircase time retriggerable ?" is fixed to "no" since retriggering is effected by the time extension.

Presetting the "Time preset via the bus" as additional function to the Staircase function

With the time preset via the bus function, the parameterized staircase time can be multiplied with an 8-bit factor received from the bus and thus dynamically adapted. In this setting, the factor is derived from the "Staircase time factor" object. The factor for setting the staircase time lies in a range between 1...255.

The overall staircase time is the product of the factor (object value) and the base (parameterized staircase time) as follows...

Staircase time = (staircase time object value) x (staircase time parameter)

Example:

object value "Staircase time factor" = 5; parameter "Staircase time" = 10s.

→ staircase time selected = 5 x 10s = 50 s.

As an alternative, it is possible to define in the parameters of the staircase function whether the reception of a new factor starts at the same also the staircase time of the staircase function. In this case, the "Staircase function start / stop" object is not existing and starting and stopping is controlled by the factor value received.

The staircase function must have been enabled on parameter page "Ax – Enabled functions".

- Set the parameter "Supplementary function for staircase function" on parameter page "Ax – Staircase function" to "Time preset via the bus" and the parameter "Staircase function activatable via object 'Staircase function factor' ?" to "no".

The staircase time can be adapted dynamically by means of the "Staircase function factor" object. A value of "0" is interpreted as a value of "1". Starting and stopping of the Staircase function is effected exclusively via the "Staircase function start / stop" object.

- Set the parameter "Supplementary function for staircase function" on parameter page "Ax – Staircase function" to "Time preset via the bus" and the parameter "Staircase function activatable via object 'Staircase function factor' ?" to "yes".

The staircase time can be adapted dynamically by means of the "Staircase function factor" object. In addition, the staircase function is started on reception of a new factor with the new staircase time (the "Staircase function start / stop" object is not existing). A factor value of "0" is interpreted as an OFF-telegram with the parameterized reaction to an OFF-telegram being evaluated in this case, too.

A large staircase with several floors is a good example for a possible application of the 'time preset via the bus' function with automatic starting of the staircase time. A push button sensor on each floor of the house transmits a factor value to the staircase function. The higher the floor, the greater the transmitted factor value in order to ensure that the lights remain on longer when it takes more time to reach the upper floors. When a person enters the staircase of the house and after pressing of the touch sensor key, the staircase time is now dynamically adapted and the lighting switched on at the same time.

- ❗ Setting "Staircase function activatable via object 'Staircase function factor' ?" = "yes": A factor of > 0 received during the pre-warning time always retrigger the staircase lighting time independent of the "Staircase time retriggerable ?" parameter.
- ❗ After a reset (bus or mains voltage return or ETS programming operation), the "Staircase function factor" object is always initialized with a "1". This alone is not sufficient for automatic starting of the staircase function (cf. "Presetting the behaviour of the staircase function after bus voltage return").
- ❗ The two supplementary functions "Time extension" and "Time preset via the bus" can now be parameterized as an alternative.

Presetting the behaviour of the staircase function after bus/mains voltage return

As an option, the staircase function can be started automatically after bus or mains voltage return. The staircase function must be enabled.

- Set the parameter "Behaviour after bus or mains voltage return" on parameter page "Ax – General" to "activate staircase function".

The staircase time of the staircase function is started immediately after bus or mains voltage return.

- ⓘ For this setting it is indispensable that the staircase function has been programmed and enabled beforehand. If the staircase function has not been enabled, this setting will produce no reaction after return of bus/mains voltage.
- ⓘ The parameterized behaviour will only be executed, if no forced-control function is active after bus voltage return.

Scene function

Up to 8 scenes can be created and the corresponding scene values stored in the actuator separately for each output. The scene values are recalled or stored via a separate scene extension object by means of extension telegrams. The datapoint type of the extension object permits addressing of up to 64 scenes max. For this reason, the scene number (1...64) with which the internal scene (1...8) is addressed can be determined in the parameterization of a scene.

The scene function must have been enabled on parameter page "Ax – Enabled functions" separately for each output before the required communication objects and parameters (on parameter page "Ax – Scenes") are visible.

The scene function can be combined with other functions of the output (cf. fig. 20). In this case, the brightness level last received or adjusted is always executed:

A telegram to the "Switching", "Dimming" or "Brightness value" objects, a scene recall or a scene storage telegram at the time of an active staircase function ends the staircase time prematurely and sets the output to the brightness level corresponding to the object (time delays taken into account) or the scene value received. Similarly, the brightness level of the output set by the "Switching", "Dimming" or "Brightness value" objects or by a scene recall can be overridden by a staircase function.

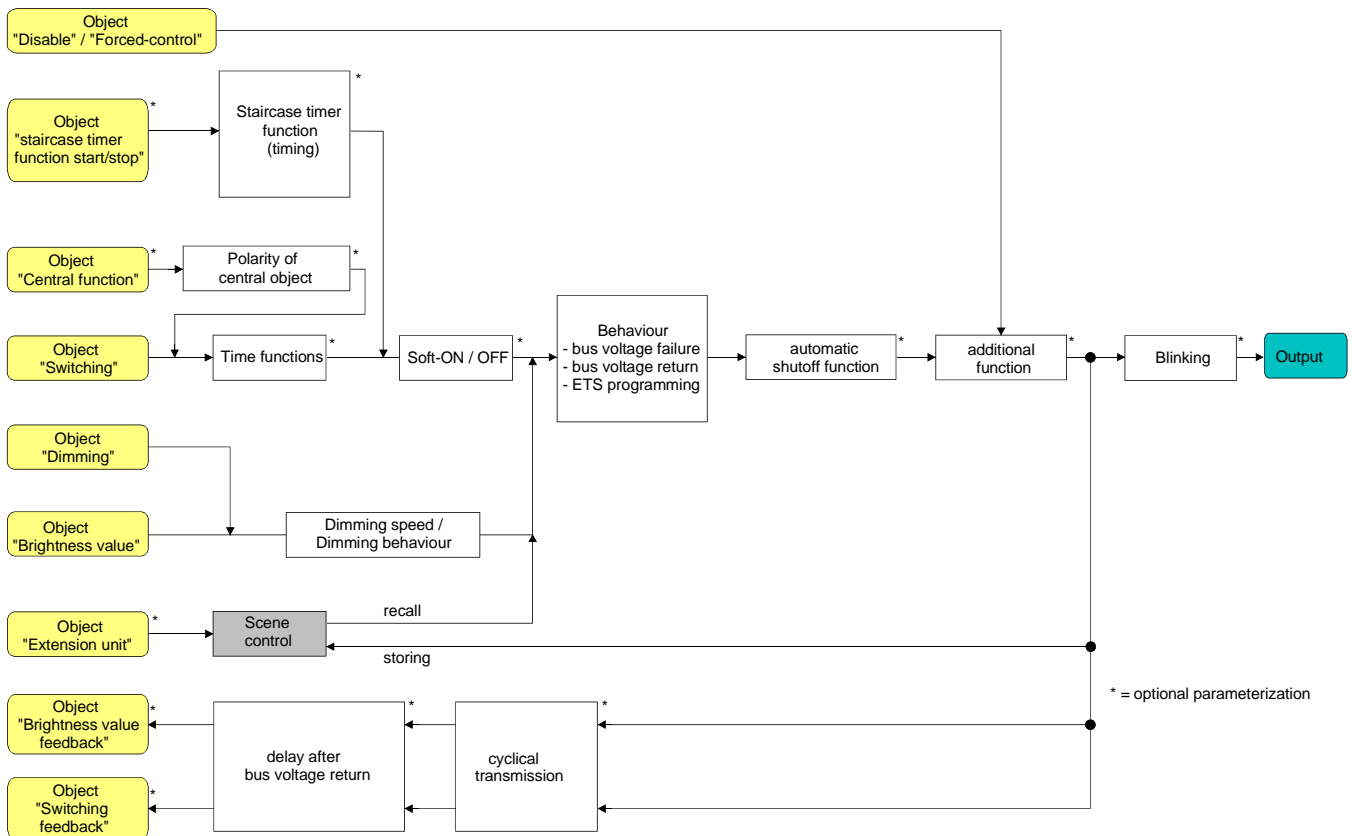

Fig. 20: Functional diagram of the scene function

Presetting a scene recall delay for the scene function

Each scene recall of an output can optionally also be delayed. With this feature, dynamical scene sequences can be configured if several outputs are combined with cyclical scene telegrams.

The scene function must be enabled on parameter page "Ax – Enabled functions (x = number of output 1...4).

- Set the parameter "Delay scene recall ?" on parameter page "Ax – Scenes" to "yes".
The delay time is now activated and can be parameterized separately. The delay only influences the scene recall of the output. The delay time begins on arrival of a recall telegram. The corresponding scene will be recalled and the output set to the respective brightness level only after this time has elapsed.
- ❗ Each scene recall telegram restarts the delay time and retriggers it. If a new scene recall telegram is received while a delay is active (scene recall not yet executed), the old (and not yet recalled scene) will be rejected and only the scene last received executed.
- ❗ The scene recall delay has no influence on the storage of scene values. A scene storage telegram within a scene recall delay terminates the delay and thus the scene recall.

Setting the response to a scene recall

The scene configuration of an output can be used to define whether the actuator recalls scene brightness value by direct or by gradual approach. In case of the gradual approach it is also possible to specify whether a dimming cycle is effected in dimming steps or by fading. A scene recall can thus be effected independently of the preset dimming behaviour and of the dimming characteristics of an output.

The behaviour after a scene recall can be configured separately for each scene.

The scene function must be enabled on parameter page "Ax – Enabled functions (x = number of output 1...4).

- Set the parameter "Response to a scene recall" on parameter page "Ax – Scenes" to "direct jump to brightness value".
The scene brightness values are approached directly in case of recall.
- Set the parameter "Response to a scene recall" on parameter page "Ax – Scenes" to "gradual dimming to brightness value". Define at the same time the required "dimming step time (0...255 ms)" for gradual approach to scene brightness value.
The scene brightness values of the corresponding scene are approached gradually in case of recall. The time in the parameter selection defines the duration of the dimming cycle between 2 of 255 dimming steps.
- Set the parameter "Response to a scene recall" on parameter page "Ax – Scenes" to "gradual dimming to brightness value by fading". Define at the same time the required "fading time (0...240 s)" for gradual approach to scene brightness value.
The scene brightness values of the corresponding scene are approached gradually in case of recall. The dim-fading mode is activated. The time in the parameter selection defines the duration of the dimming cycle until the scene brightness value is reached. The brightness level of an output from which the dimming cycle starts is then of no importance. This means that the dimming cycle in case of scene recall always needs exactly the specified time.

Presetting the ETS download behaviour for the scene function

During storage of a scene, the scene values are stored permanently in the device (cf. "Presetting the storage behaviour for the scene function"). To prevent the stored values from being replaced during application or parameter programming with the ETS by the originally programmed scene brightness levels, the actuator can inhibit overwriting of the scene values. As an alternative, the original values can be reloaded into the device during each ETS programming operation.

The scene function must be enabled on parameter page "Ax – Enabled functions (x = number of output 1...4).

- Set the parameter "Overwrite values stored in the device during download ?" on parameter page "Ax – Scenes" to "yes".

During each application or parameter programming with the ETS, the scene values parameterized in the ETS for the output concerned will be programmed into the actuator. Scene values stored in the device by means of a storage function will be overwritten, if any.

- Set the parameter "Overwrite values stored in the device during download ?" on parameter page "Ax – Scenes" to "yes".

Scene values stored in the device with a storage function will be maintained. If no scene values have been stored, the brightness values last programmed with the ETS remain valid.

- ❗ When the actuator is put into operation for the first time, this parameter should be set to "yes" so that the output is initialized with valid scene values.

Presetting scene numbers and scene brightness values for the scene function

The datapoint type of the scene extension object permits addressing of up to 64 scenes max. For this reason, the scene number (1...64) with which the scene is addressed, i.e. recalled or stored, must be determined for each internal scene (1...8) of the output. Moreover, the brightness value to be set at the output in case of a scene recall must be specified as well.

The scene function must be enabled on parameter page "Ax – Enabled functions (x = number of output 1...4).

- Set the parameter "Scene x activatable by scene number" (x = number of the scene (1...8)) for each scene on parameter page "Ax – Scenes" to the numbers with which the scenes are to be addressed. A scene can be addressed with the parameterized scene number. A setting of "0" deactivates the corresponding scene so that neither recalling nor storage is possible.

- ❗ If the same scene number is parameterized for several scenes, only the scene with the lowest internal scene number (1...8) will be addressed. The other internal scenes will be ignored in this case.

- Set the parameter "Brightness value for scene x" (x = number of the scene (1...8)) on parameter page "Ax – Scenes" for each scene to the desired brightness value.
In case of a scene recall, the parameterized brightness value is recalled and the output is set to this value.
- ❗ The parameterized brightness value is adopted by the actuator during programming with the ETS only if the parameter "Overwrite scene values during ETS download" is set to "yes".
- ❗ It must be ensured that the parameterized scene brightness value is below the preset maximum brightness level.

Presetting the storage behaviour for the scene function

The scene brightness value adjusted at the output in accordance with the functional diagram can be stored internally via the extension object – even during the dimming cycle. In this case, the brightness value can be influenced before storage by all functions of the output provided the individual functions have been enabled (e.g. also the disabling function, forced-control function, etc.).

The scene function must be enabled on parameter page "Ax – Enabled functions (x = number of output 1...4).

- Set the parameter "Storage function for scene x" (x = number of the scene (1...8)) on parameter page "Ax – Scenes" for each scene to "yes".
The storage function is activated for the scene in question. On reception of a storage telegram via the "Scene extension" object, the current position value will be internally stored.
- Set the parameter "Storage function for scene x" (x = number of the scene (1...8)) on parameter page "Ax – Scenes" for each scene to "no".
The storage function is deactivated for the scene in question. A storage telegram received via the "Scene extension" object will be rejected.

Operating hours counter

The operating hours counter tracks the ON-time of a dimming output. For the operating hours counter an output is actively on, when the brightness value is greater than "0", i.e. when current is flowing into the load.

The operating hours counter sums up the determined ON-time for a closed relay contact precise to the minute rounding the times off to full hours (cf. fig. 21). The accumulated operating hours are tracked in a 2-byte counter and stored permanently in the device. The current count can be transmitted cyclically or after a change by a counting interval to the bus via the communication object "Value operating hours counter".

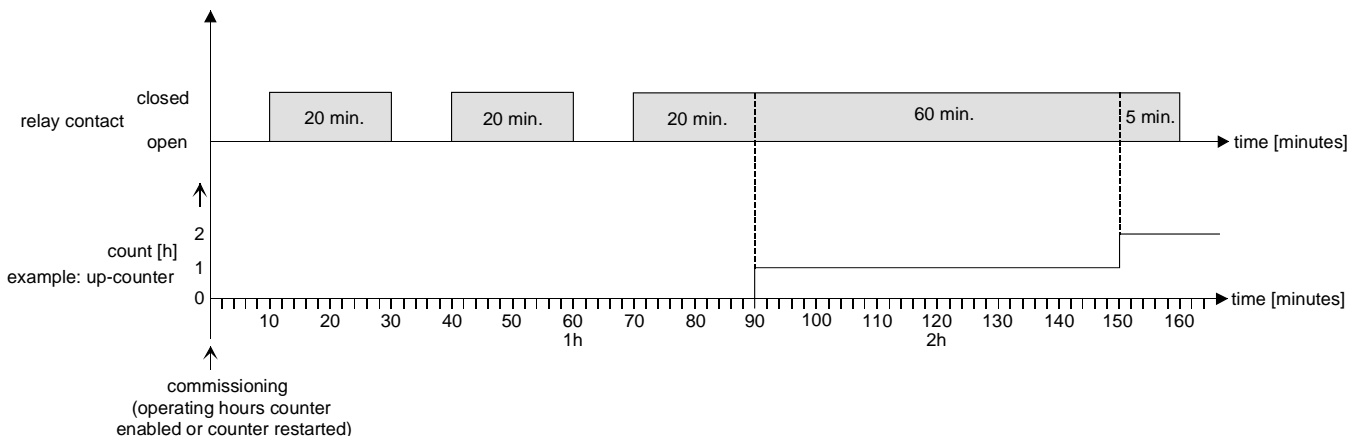

Fig. 21: Functional principle of the operating hours counter

In the as-supplied state, the operating hours count for all outputs of the actuator is "0". If the operating hours counter has not been enabled in the parameters of the output concerned, no operating hours will be counted for the output in question. If enabled, the operating hours counter begins counting and summing up the operating hours immediately after commissioning of the actuator with the ETS. If an operating hours counter is later on again disabled in the parameters and if the actuator is then programmed with the counter disabled, all operating hours counted beforehand for the output concerned will be deleted. After re-enabling, the operating hours counter always begins with "0".

The operating hours stored in the device (full hours) are not lost after a bus voltage failure or after programming with the ETS. Accumulated operating minutes (full hour not yet reached) are, however, discarded in this case.

After bus / mains voltage return or an ETS download the actuator passively updates the communication object "Value operating hours counter" for each output. The object value can be read out, if the Read flag is set. Depending on the automatic transmission parameters, the object value, if any, is actively transmitted to the bus as soon as the parameterized transmit delay after bus voltage return has elapsed (cf. "Presetting the transmission behaviour of the operating hours counter").

Any operation of the outputs by manual control is detected by the operating hours counter with the result that the activation of an output will start an operating hours count and that the deactivation of this output will stop the count.

No operating hours will be counted if the mains voltage supply of the actuator or of individual load outputs is off.

Activating the operating hours counter

- Set the parameter "Operating hours counter" on parameter page "Ax – Enabled functions" to "enabled".

The operating hours counter is activated.

Deactivating the operating hours counter

- Set the parameter "Operating hours counter" on parameter page "Ax – Enabled functions" to "disabled".

The operating hours counter is deactivated.

- ❗ Disabling of the operating hours counter and subsequent programming with the ETS causes the counter to be reset to "0".

Presetting the Type of counter of the operating hours counter

The operating hours counter can be configured as an up-counter or a down-counter. Depending on the above mode, the counter permits presetting a limit or starting value which can be used, for instance, to monitor the hours in operation of a lamp by restricting the counting range.

UP-counter:

After activation of the operating hours counter by enabling it in the ETS or by a restart, the operating hours will be counted started from "0". The maximum counting capacity is 65535 hours. Thereafter, the counter stops and reports reaching the maximum count via the "Runout operating hours counter" object .

As an option, a limit value can be preset either in the ETS or via the communication object "Limit value perating hours counter". In this case, the counting status is reported to the bus via the "End-of-counting" object already when the limit value is reached. If not restarted, the counter will nevertheless continue counting until the max. capacity of 65535 hours is reached and stop thereafter. A new count begins only after the counter is restarted.

DOWN-counter:

After enabling the operating hours counter in the ETS, the count is "0" and the actuator reports for the output concerned after programming or after a bus voltage return via the "Runout operating hours counter" object that the counter is running. Only after a restart will the DOWN-counter be preset to the max. value of 65535 and the counting operation be started.

As an option, a start value can be preset either in the ETS or via the communication object "Start value operating hours counter ". If a start value has been preset, the DOWN-counter will be initialized after a restart with this value instead of the max. value. The counter will then decrement the hours beginning with the start value. When the DOWN-counter has reached "0", the counting status is reported to the bus via the "Runout operating hours counter" object and counting is stopped. A new count begins only after the counter is restarted.

The operating hours counter must have been enabled on parameter page "Ax – Enabled functions (x = number of output 1...4).

- Set the parameter "Type of counter" on parameter page "Ax - Operating hours counter" (x = number of output 1...4) to "Up-counter". If limit value monitoring is desired, set the parameter "Limit value preset ?" to "yes, as specified in parameter" or to "yes, as received via object". In all other cases, set the parameter to "no". In the "yes, as specified in parameter" setting, specify the required limit value (1...65535 h).

The counter increments the operating hours beginning with "0". If the limit value monitoring function is active, the actuator sends a "1" telegram for the output concerned via the "End-of-counting" object as soon as the preset limit value is reached. Otherwise, the counter status will be transmitted only after reaching the max. value of 65535.

- Set the parameter "Type of counter" on parameter page "Ax - Operating hours counter" (x = number of output 1...4) to "Down-counter". If a start value preset is required, set the parameter "Start value preset ?" to "Yes, as specified in parameter" or to "Yes, as received via object". In all other cases, set the parameter to "no". In the "yes, as specified in parameter" setting, specify the required start value (1...65535 h).

After a restart, the counter decrements the operating hours until "0" is reached. If the start value preset mode is active, the counter counts down from the start value. Otherwise, counting begins from the max. value 65535. The actuator sends a "1" telegram for the output concerned via the object "Runout operating hours counter" as soon as "0" is reached.

- ❗ The value of the communication object "Runout operating hours counter" is stored internally in a non-volatile memory. After bus / mains voltage return or after an ETS programming operation, the object will be re-initialized with the previously stored value. If an operating hours counter is identified as run out in this case, i.e. if the object value is a "1", an additional telegram will be actively transmitted to the bus as soon as the parameterized transmit delay has elapsed after bus voltage return. If the counter has not yet run out (object value "0"), then no telegram will be sent after bus / mains voltage return or after an ETS programming operation.
- ❗ In case of limit or start value preset via an object: The values received via the object will be adopted as valid only after a restart of the operating hours counter and stored internally in a non-volatile memory. After bus / mains voltage return or after an ETS programming operation, the object will be initialized with the value last stored. The values received are lost during a bus / mains voltage failure or an ETS download, if the counter has not been restarted beforehand. For this reason, it is recommended to always restart the counter whenever a new start or limit value is being preset. As long as no limit or start value has been received via the object, a fixed standard value of 65535 is the default. The values received via the object and stored will be reset to the default value, if the operating hours counter is disabled in the parameters of the ETS and if an ETS download is made.
- ❗ In case of limit or start value preset via an object: If the start or limit value is preset as "0", the actuator ignores a counter restart in order to avoid an undesired reset (e.g. site operation → hours already counted by manual operation).
- ❗ If the counting direction of an operating hours counter is reversed by parameter change in the ETS, the counter should always be restarted after programming of the actuator to ensure its re-initialization.

Restarting the operating hours counter

The operating hours count can be reset at any time by the "New start operating hours counter" communication object. The polarity of the restart telegram object is fixed. 1" = restart / "0" = no reaction.

- Set the communication object "New start operating hours counter" to "1".
In case of an Up-counter, the counter will be initialized during restart with a "0" and in case of a Down-counter with the start value. If no start value has been parameterized or preset via the object, the start value is fixed with 65535.

During each restart of the counter, the initialized count will be transmitted actively to the bus.

During a restart, the 'end-of-counting' message will be reset as well. In this case, a "0" telegram will be transmitted to the bus via the "Runout operating hours counter" object.

In addition, the limit or start value will be initialized as well.

- ❗ If a new limit or start value has been preset via the communication object, the counter should always be restarted thereafter. Otherwise, the received values will be lost during a bus / mains voltage failure or an ETS download.

- ❗ If a start or a limit value is preset with "0", the device will show different reactions during a restart depending on the type of value preset...

Preset like parameter: The counter runs out immediately after a counter restart.

Preset via object:

A counter restart will be ignored to avoid an undesired reset (e.g. after installation of the devices with hours already being counted by manual operation). To perform the restart, it is necessary to preset at first a start or limit value greater than "0".

Presetting the transmission behaviour of the operating hours counter

The current value of the operating hours counter is always tracked in the communication object "Value operating hours counter". After bus / mains voltage return or an ETS download the actuator passively updates the communication object "Value operating hours counter" for each output. The object value can be read out, if the Read flag is set.

In addition, the transmit behaviour of this communication object can be preset.

The operating hours counter must have been enabled on parameter page "Ax – Enabled functions (x = number of output 1...4).

- Set the parameter "Automatic transmission of counting value" on parameter page "Ax – Operating hours counter" (x = number of output) to "after change by interval value". Set the parameter "Counting value interval (1..65535)" to the desired value.

The count is transmitted to the bus as soon as it changes by the preset Counting value interval. After bus / mains voltage return or after an ETS programming operation, the object value will be automatically transmitted after the "Delay after bus voltage return" has elapsed, when the current count corresponds to the Counting value interval or a multiple thereof. A count of "0" will in this case always be transmitted.

- Set the parameter "Automatic transmission of counting value" on parameter page "Ax – Operating hours counter" (x = number of output) to "cyclical".

The counter value is transmitted cyclically. The cycle time is defined channel-independent on parameter page "Time settings". After bus / mains voltage return or after programming with the ETS, the count will be transmitted to the bus for the first time after the parameterized cycle time has elapsed.

Supplementary functions

For each dimming output, additional functions can be enabled. As additional function, a disabling function or alternatively a forced-control function can be configured. Only one of these functions can be enabled for an output.

The additional functions are enabled and parameterized on parameter page "Ax - Supplementary functions" (x = number of output 1...4).

Presetting the disabling function as supplementary function

During an active disable, the KNX/EIB bus operation of the output concerned is overridden and interlocked (cf. fig. 22). By overriding the output it is possible to implement a permanent lighting function.

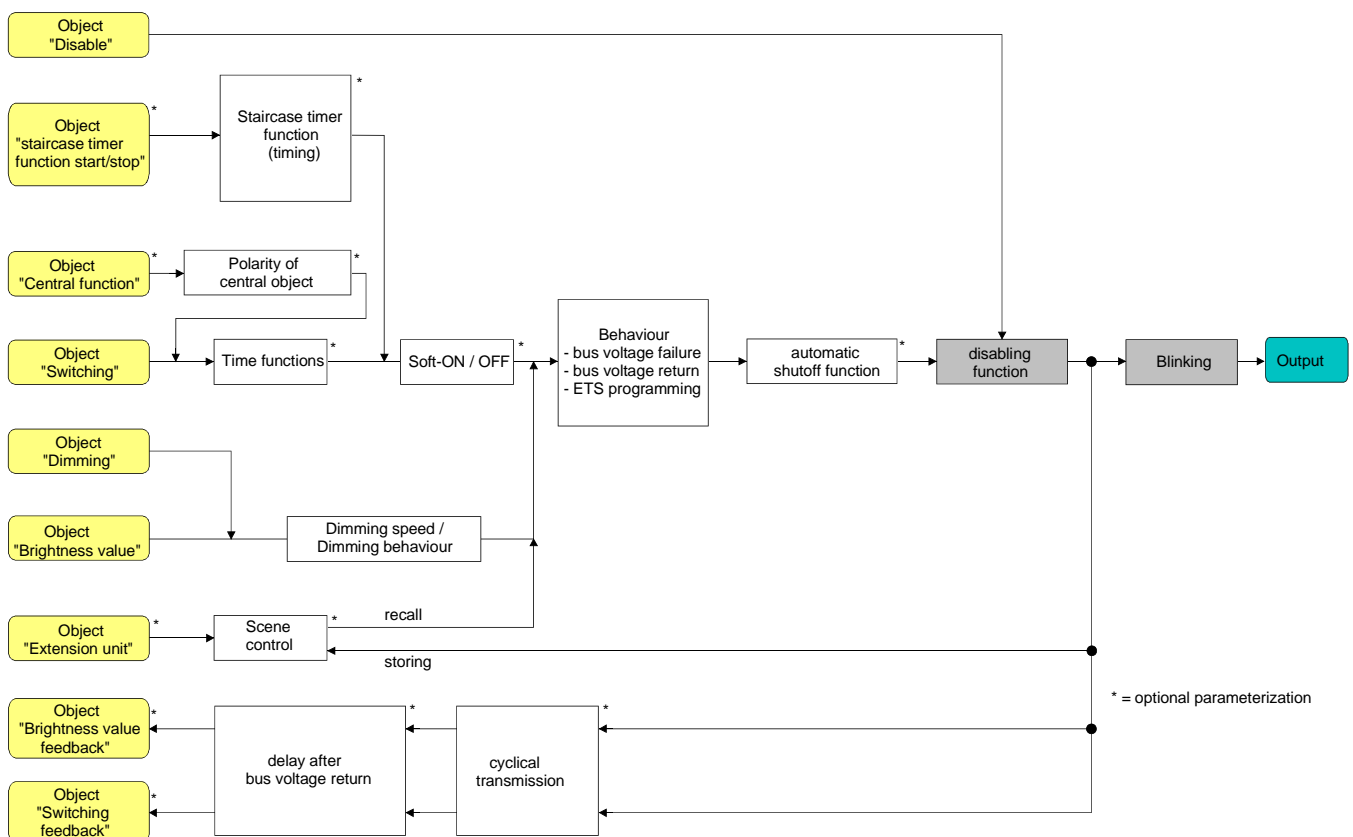

Fig. 22: Functional diagram of the disabling function

- Set the parameter "Selection of supplementary function" on parameter page "Ax – Supplementary functions" (x = number of output 1...4) to "disabling function".

The disabling function is enabled. The "Disabling" communication object and the parameters of the disabling function are visible.
- Set the parameter "Polarity of disable object" on parameter page "Ax – Supplementary functions" to the desired polarity.

- Set the parameter "Behaviour at the beginning of the disabling function" on parameter page "Ax – Supplementary functions" to the desired behaviour.

At the beginning of disabling, the parameterized behaviour will be executed and bus control of the output interlocked. In the "no reaction" setting, the output shows no reaction and remains at the brightness level last adjusted.

When "blinking" is selected, the output is switched on and off cyclically during disable. The blinking rate is generally parameterized for all outputs on parameter page "General". During the blinking interval, the logic switching state of the output is reported back as "switched on - 1" and the brightness value as "switch-on brightness". Soft-ON / soft-OFF functions, if any, will not be executed during the blinking interval.

If the parameter is set to "memory value", the output is adjusted to the brightness value that was active and internally stored before the last shut-off (via the "Switching" or the "Central function" object). This memory value is stored non-permanently which means that this value preset to maximum brightness after a mains voltage return or after an ETS programming operation. A bus voltage failure alone is not sufficient to delete the memory value.
 - Set the parameter "Behaviour at the end of the disabling function" on parameter page "Ax – Supplementary functions" to the desired behaviour.

At the end of disabling, the parameterized behaviour will be executed and bus control of the output re-enabled. In the "no reaction" setting, the output shows no reaction and remains at the brightness level last adjusted by the disabling function.

In the "tracked brightness value" setting, the state received during the disabling function or the state adjusted before the disabling function will be tracked at the end of disable the corresponding brightness level. Running time functions, if any, will also be considered.

When "blinking" is selected, the output is switched on and off cyclically after disabling. The blinking rate is generally parameterized for all outputs on the "General" parameter page. During the blinking interval, the logic switching state of the output is reported back as "switched on - 1" and the brightness value as "switch-on brightness". Soft-ON / soft-OFF functions, if any, will not be executed during the blinking interval. The blinking state remains active until another bus command with another brightness state is being received.

If the parameter is set to "memory value", the output is adjusted to the brightness value that was active and internally stored before the last shut-off (via the "Switching" or the "Central function" object). This memory value is stored non-permanently which means that this value preset to maximum brightness after a mains voltage return or after an ETS programming operation. A bus voltage failure alone is not sufficient to delete the memory value.
- i** If a brightness value is parameterized for the beginning and for the end of the disabling function, the selected value must not exceed the maximum brightness preset in the ETS!
 - i** After a bus or a mains voltage failure or after programming of the application or of the parameters with the ETS, the disabling function is always deactivated (object value "0"). In the inverted setting ("1 = enabled; 0 = disabled"), a "0" telegram update must first be sent after the initialization before the disabled state is activated.
 - i** Updates of the disabling object from "activated" to "activated" or from "deactivated" to "deactivated" show no reaction.
 - i** An output disabled via the KNX/EIB can nevertheless be operated by hand! At the end of a manual control cycle, the actuator re-executes the disabling function for the output concerned if the disabling function is still activated at this time.
 - i** In case of the "tracked brightness value" setting: During disabling, the overridden functions of the actuator (switching, dimming, brightness value, scenes) continue to be processed internally. This means that all newly received bus telegrams will be evaluated and that time functions will be triggered. At the end of disabling, the states thus tracked will be taken over.

Presetting the forced-control function as supplementary function

As can be seen from the functional diagram (cf. fig. 23), the forced-control function can also be combined with other output functions. In case of an active forced-control function, the preceding functions are overridden so that the output concerned will be interlocked.

The forced-control function has a separate 2-bit communication object of its own. The first bit (bit 0) of the "Forced-control position" object determines whether the output is switched off or on by Forced-control position. In the case of forced-control switch-on, an ETS parameter determines the brightness level with which the lights are switched on. The second bit (bit 1) activates or deactivates the forced-control state (cf. table 2).

The behaviour of an output at the end of the forced-control function can be parameterized. The forced-control object can moreover be initialized on return of bus voltage.

Bit 1	Bit 0	Function
0	X	Forced-control position not active ⇒ normal control
0	X	Forced-control position not active ⇒ normal control
1	0	Forced-control position active: switching off
1	1	Forced-control position active: switching on with predefined brightness

Table 2: Forced-control position bit coding

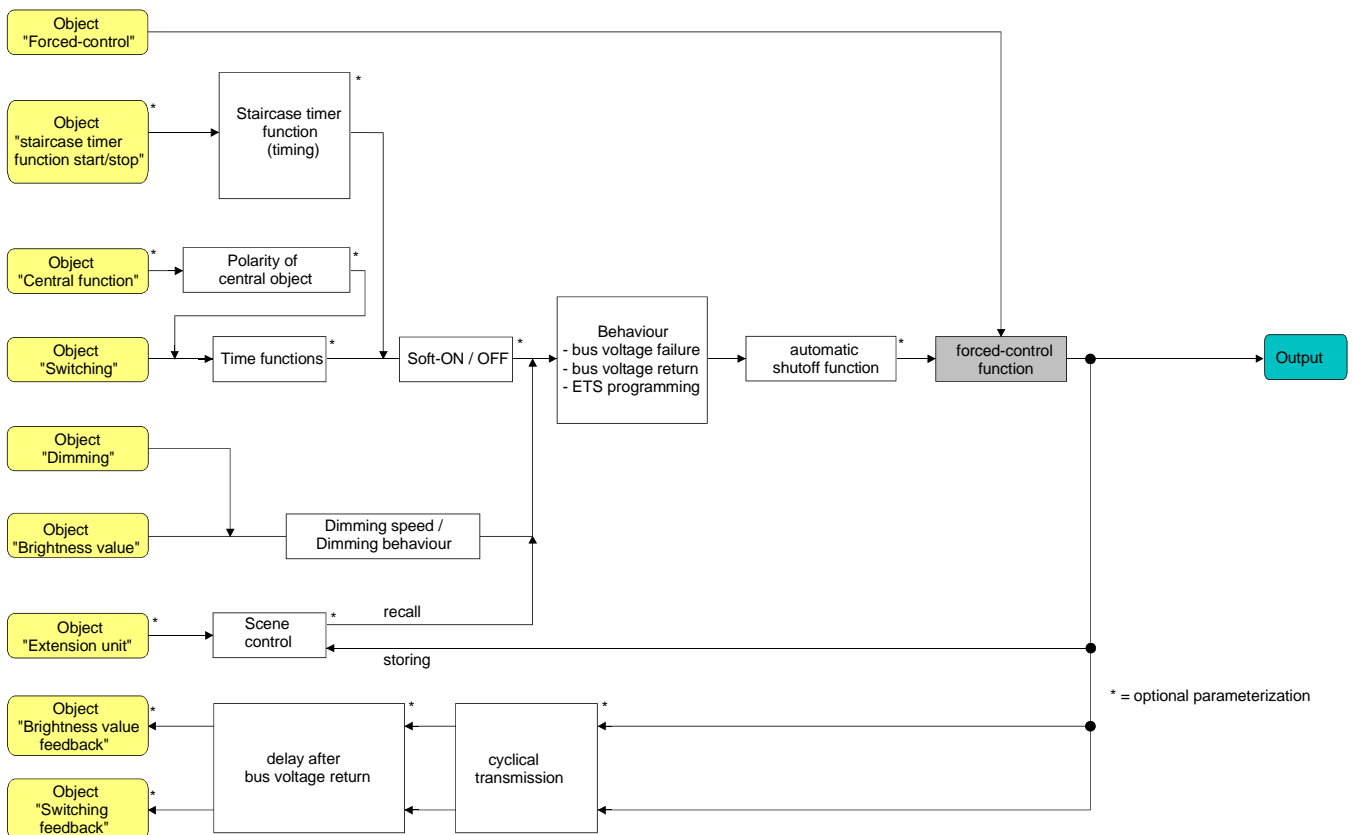

Fig. 23: Functional diagram of the forced-control function

- Set the parameter "Selection of supplementary function" on parameter page "Ax – Supplementary functions" to "Forced-control position".

The forced-control function is enabled. The "Forced-control position" communication object and the parameters of the forced-control function are visible.
 - Set the parameter "Brightness for forced-control position active, ON" on parameter page "Ax - Supplementary functions" to the desired reaction, when a Forced-control position is activated via the communication object.

If a brightness value has been preset, the output is adjusted to this brightness in a forced-control situation. The selected forced-control brightness must not exceed the maximum brightness parameterized in the ETS!

In the "no reaction" setting, the bus control of the output is interlocked, but the output shows no reaction and remains at the brightness level last adjusted.

If the parameter is set to "memory value", the output is adjusted to the brightness value that was active and internally stored before the last shut-off (via the "Switching" or the "Central function" object). This memory value is stored non-permanently which means that this value preset to maximum brightness after a mains voltage return or after an ETS programming operation. A bus voltage failure alone is not sufficient to delete the memory value.
 - Set the parameter "Response at the end of the forced-control position function" on parameter page "Ax – Supplementary functions" to the desired behaviour.

At the end of Forced-control position, the parameterized behaviour will be executed and bus control of the output re-enabled. In the "no reaction" setting, the output shows no reaction and remains at the brightness level last adjusted by Forced-control position.

In the "tracked brightness value" setting, the brightness value received during the disabling function or the value adjusted before the disabling function will be tracked at the end of the forced-control state. Running time functions, if any, will also be considered.
- ⓘ The "Brightness for forced-control position 'active, OFF'" is set invariably to "switching off".
 - ⓘ Updates of the forced-control object from "forced-control active" to "forced-control active" while maintaining the forced switching status or from "forced-control inactive" to "forced-control inactive" show no reaction.
 - ⓘ An output disabled via the KNX/EIB can nevertheless be operated by hand! At the end of a manual control cycle, the actuator re-executes the force-control position function for the output concerned if Forced-control position is still activated at this time.
 - ⓘ In case of the "tracked brightness value" setting at the end of Forced-control position: During Forced-control position, the overridden functions of the actuator (switching, dimming, brightness value, scenes) continue to be processed internally. This means that all newly received bus telegrams will be evaluated and that time functions will be triggered. At the end of Forced-control position, the states thus tracked will be taken over.
 - ⓘ The current state of the force-control position object will be stored in case of bus or mains voltage failure.

- Set the parameter "Behaviour after bus voltage return" on parameter page "Ax – Supplementary functions" to the desired behaviour.

After bus voltage return, the parameterized state is adopted in the "Forced-control position" communication object. In case of active forcing, the output will be switched immediately after bus voltage return to the corresponding state and interlocked by forced-control position until forcing is released via the bus. The parameter "Behaviour after bus / mains voltage return" on parameter page "Ax - General" will in this case not be evaluated for the output concerned.

If the "state of forced-control as before bus voltage failure" setting is selected, the forced-control state last adjusted and internally stored before bus or mains voltage failure will be tracked after bus voltage return. An ETS programming operation deletes the stored state (reaction in that case same as with "no Forced-control position active").

If the tracked state corresponds to "no Forced-control position", the forced-control-independent parameter "Behaviour after bus / mains voltage return" (parameter page "Ax – General") will be executed on return of bus voltage. In case of active forcing, the output will be switched on with the brightness value defined by the "Brightness for forced-control position 'active, ON'" parameter.

- ❗ On return of mains voltage, the force-control position function is always deactivated.
- ❗ After programming of the application or of the parameters with the ETS, the force-control position function is always deactivated (object value "0").

Dimming characteristics, dimming behaviour and dimming speeds

The brightness of lamps connected to a dimming output can be varied by a dimming procedure. The brightness range that can be used for dimming is defined at the limits by the basic and maximum brightness levels parameterized in the ETS.

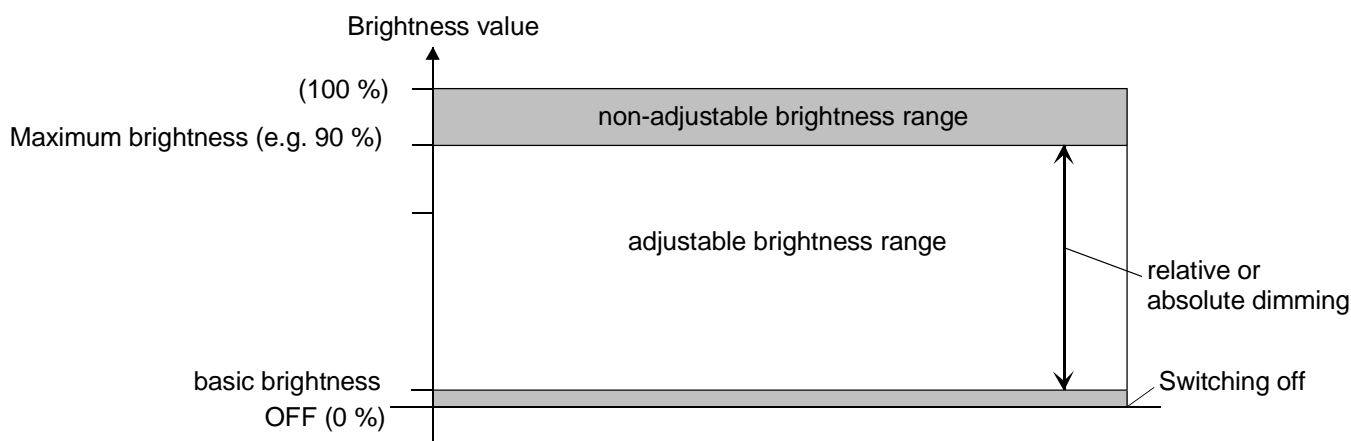

Fig. 24: Usable brightness range for dimming (example)

The brightness of an output can be varied by ...

- relative dimming:
Relative dimming can either be triggered by the 4-bit communication object "Dimming" existing separately for each output or by means of a long key-press in the manual control mode. The data format of the "Dimming" object corresponds to the KNX standardization for DPT "3.007" so that it is possible to preset the dimming direction and relative dimming step times and also to stop dimming procedures in the dimming telegram. In relative dimming by means of a manual control operation locally on the dimming actuator itself, a dimming cycle is executed as long as the corresponding key is depressed. The dimming procedure stops on releasing the key or when the basic or maximum brightness values are reached.
- absolute dimming:
Absolute dimming is triggered by presetting a brightness value. This value can be preset from the KNX/EIB via the 1-byte communication object "Brightness value" existing separately for each output. The presetting of brightness values by a disabling or force-control position function or the scene function is also possible. Absolute dimming by presetting brightness values can also be activated in case of bus voltage failure or on bus/mains voltage return or after an ETS programming operation. In case of presetting the brightness value via the object or by a scene recall, it is possible to program in the ETS whether the brightness value is to be approached directly or – as an alternative – gradually by means of the configured dimming step times or by fading. In all other absolute dimming functions, the set brightness values are always approached directly.

The dimming speed is not the same for relative dimming and for the gradual approach of a preset absolute brightness value (not fading) and can be preset separately for each dimming output in the characteristics parameters of the ETS.

i Even in the direct approach of brightness values, the connected lamps can always be seen performing a very brief dimming cycle. This is also the case for switching without soft-ON or soft-OFF function. This dimming cycle is required for reasons inherent in the system. The directly approached brightness value is reached with the minimum dimming step time of 1 ms. This time cannot be changed.

Configuring the dimming characteristics

In the universal dimming actuator, the full brightness range (basic brightness ... 100 %) is divided into 255 dimming steps (8-bit brightness value: 1...255 / 0 = off) In the as-supplied state of the actuator, the dimming step times, i.e. the dimming times between 2 of the 255 dimming steps are adjusted to the same length. This results in a linear dimming characteristic over the whole brightness range (cf. fig. 25).

The dimmable brightness range is limited at the upper end by the maximum brightness configured in the ETS. The lower limit is given by the basic brightness (brightness value = 1).

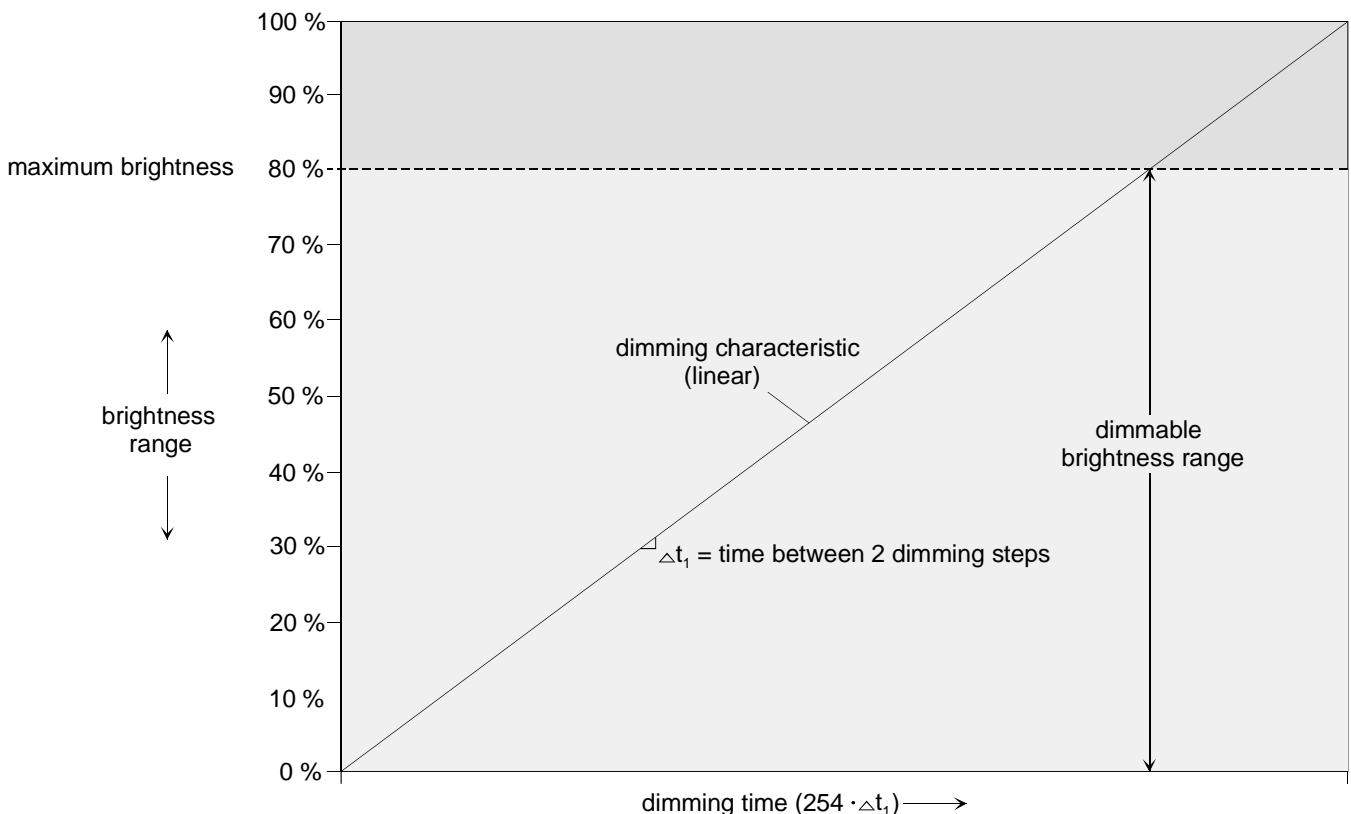

Fig. 25: Example of a linear dimming characteristic with a maximum brightness < 100 %

In some practical applications, a linear dimming characteristic is not optimal. For this reason, the dimming characteristic of the universal dimming actuator can alternatively be adapted in ETS to user requirements. This feature permits adapting the brightness changes during the dimming cycle to the subjective sensation of brightness of the human eye by dividing the brightness range into up to three sub-ranges with different dimming step times (cf. fig. 26).

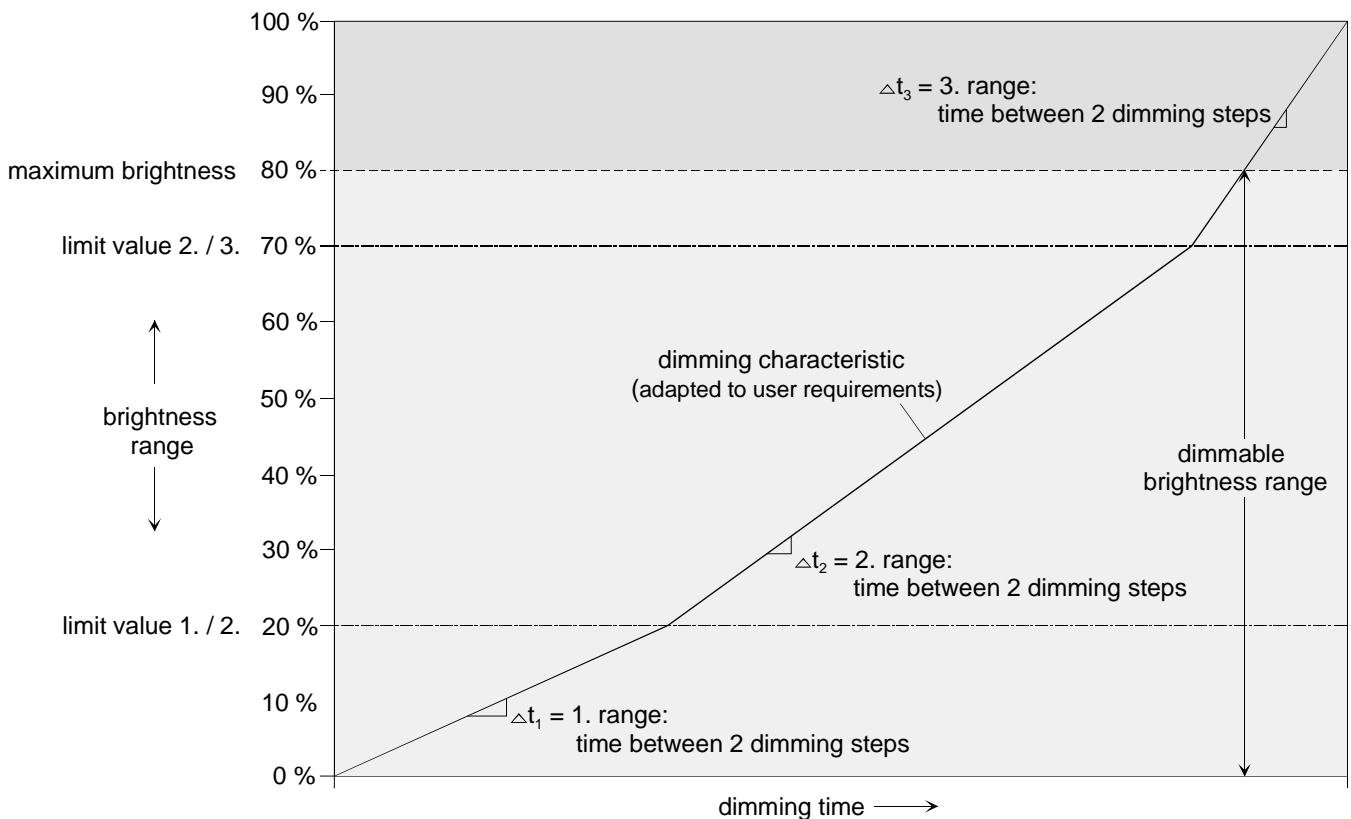

Fig. 26: Example of dimming characteristic adapted to user requirements with three brightness ranges and different dimming step times and maximum brightness < 100 %

A further option permits presetting predefined dimming characteristics for incandescent or for halogen lamps in the corresponding parameters. With this option, the dimming characteristic can be optimized for the mentioned load types without having to parameterize a dimming step time. In this case, the dimming actuator works with fixed predefined brightness sub-ranges and dimming step times.

i General information: An increase of the brightness value in the dimming actuator results in a reduction of the residual phase angle at the dimming output. Similarly, a reduction of the brightness value at the dimming output results in an increase of the residual phase angle. The residual phase angle determines among other things also the dark interval of the connected lamp.

- Set the parameter "Nature of dimming characteristic" on parameter page "Ax - Dimming characteristic" (x = number of output 1...4) to "linear".
The actuator works with a linear dimming characteristic as shown in fig. 25. In addition, a dimming step time for the full brightness range can be configured in the ETS.
- Set the parameter "Nature of dimming characteristic" on parameter page "Ax = Dimming characteristic" to "user-defined".
The actuator works with a user-defined dimming characteristic as shown in fig. 26. In addition, two limit values and three dimming step times for defining three brightness sub-ranges can be preset.
- Set the parameter "Nature of dimming characteristic" on parameter page "Ax = Dimming characteristic" to "adapted to incandescent lamps".
The actuator works with a dimming characteristic specially adapted to incandescent lamps. Further settings for the dimming characteristic are not required.
- Set the parameter "Nature of dimming characteristic" on parameter page "Ax = Dimming characteristic" to "adapted to halogen lamps".
The actuator works with a dimming characteristic specially adapted to halogen lamps. Further settings for the dimming characteristic are not required.

Presetting the dimming step time

The dimming speed is the same for relative dimming and for direct approach of a preset absolute brightness value (not fading) and can be preset separately for each dimming output in the characteristics parameters of the ETS.

Configuration of a dimming step time is only required, if the nature of the characteristic is set to "linear" or "user-defined" (cf. "Configuring the dimming characteristics" above).

The parameter "Nature of dimming characteristic" is set to "linear"

- Set the parameter "Time between two dimming steps" on parameter page "Ax = Dimming characteristic" to the desired dimming step time.
During every relative or absolute dimming cycle, dimming is performed over the whole range of brightness values with the configured dimming step time.

The parameter "Nature of dimming characteristic" is set to "user-defined".

- At first, the brightness limit values must be fixed. Set the parameters "Brightness value limit 1st range / 2nd range (1...100 %)" and "Brightness value limit 2nd range / 3rd range (1...100 %)" on parameter page "Ax = Dimming characteristic" to the required sub-range limits, making sure that the brightness limit value of range 1 / 2 is less than that of range 2 / 3 (cf. fig. 26). Otherwise, risk of malfunction.
The whole brightness range (basic brightness ... 100 %) is divided into three sub-ranges. In the next parameters, the dimming step times can be preset separately for these three ranges.

- Set the parameter "... time between two dimming steps (1...255 ms)" on parameter page "Ax = Dimming characteristic" for each of the three ranges to the desired dimming step times. The dimming characteristic is now completely defined. Dimming is performed in each of the three sub-ranges with the specified dimming step time.

i The dimming step time for scenes with gradual dimming approach to scene values is defined separately in the scene parameters of an output (cf. "Scene function").

Presetting the dimming behaviour for absolute dimming via the "Brightness value" object

The dimming behaviour for absolute dimming via the "Brightness value" object can be preset separately for each output in the ETS.

- Set the parameter "Dimming response to a brightness value" on parameter page "Ax - General" (x = number of output 1...4) to "gradual dimming".
As soon as a new brightness value is received, it will be set with the configured dimming step time (cf. "Configuring the dimming characteristics" and "Presetting the dimming step time" above) and with the predefined dimming characteristic.
- Set the parameter "Dimming response to a brightness value" to "direct jump".
As soon as a new brightness value is received it will be approached directly.
- Set the parameter "Dimming response to a brightness value" to "fading". Define equally the required fading time in the parameter "Time for brightness value via fading" for the gradual approach to the brightness value.
Newly received brightness values are approached gradually. The dim-fading mode is activated. The fading time defines the duration of the dimming cycle until the new brightness value is reached. The brightness level of the output from which the dimming cycle starts and the configured dimming characteristic are of no importance. This means that the dimming cycle always needs exactly the specified time when a new brightness value is preset.

i Brightness values can also be preset by a disabling or by a forced-control position function. Absolute dimming by presetting brightness values can also be activated in case of bus voltage failure or on bus/mains voltage return or after an ETS programming operation. In these absolute dimming functions, the set brightness values are always approached directly. The dimming behaviour for scene recalls can be configured separately (cf. "Scene function").

4.2.4.4 Delivery state

In the as-supplied state, the universal dimming actuator is passive, i.e. no telegrams are transmitted to the bus. The connected loads can, however, be operated by manual control on the device itself, if the mains voltage is on. In the manual control mode, no feedback telegrams are sent to the bus. All other functions of the actuator are deactivated.



The device can be programmed and put into operation with the ETS. The physical address is preset to 15.15.255.

Moreover the device has been configured at the factory with the following data...

- Dimming principle: universal
- Time between two dimming steps in the manual control mode: 12 ms
- Basic brightness: level 5 (standard halogen)
- Maximum brightness: 100 %
- Switch-on brightness: 100 %
- Behaviour after bus voltage failure: no reaction
- Behaviour after bus voltage return: no reaction
- Behaviour after return of the actuator's mains supply: the device performs the automatic load detection procedure. This procedure depends on the conditions prevailing in the supply network and can last up to 10 seconds. Thereafter, all outputs are shut off.
- Operating hours counter: deactivated
- Behaviour at the end of the manual control mode: no change

i The as-supplied state can be restored at any time by unloading the application program with the ETS. In this case, the manual control mode continues to be available.

4.2.5 Parameters

Description:	Values:	Remarks:
 General		
Delay after bus voltage return Minutes (0...59)	0...59	To reduce telegram traffic on the bus line after bus voltage activation (bus reset), after activation of the mains supply, connection of the device to the bus line or after an ETS programming operation, it is possible to delay all active feedbacks of the actuator. The parameter specifies in this case a device-independent delay. Feedback telegrams for initialization will therefore be transmitted to the bus only after the parametrized time has elapsed. Sets the minutes of the delay time.
Seconds (0...59)	0...17...59	Sets the seconds of the delay time. <i>Presetting: 17 seconds</i>
Central function ?	yes no	Setting "yes" enables the central function and thus the "Central function" object. Individual switching outputs can be assigned to the central function only if the function is enabled
Central object polarity	0 = disabled; 1 = enabled 0 = enabled; 1 = disabled	This parameter defines the polarity of the central object.  Only visible if "Central function ? = yes"!

Blinking rate

- 1 s
- 2 s
- 5 s
- 10 s

At the beginning and at the end of a disabling function (if used), switching outputs can also be parameterized as "blinking". In this case, the connected lamps change their switching state cyclically.

The "Blinking rate" parameter generally defines the ON-time and the OFF-time of a "blinking" output signal for all outputs.

Example:

Blinking rate = 1 s

1 s on → 1 s off → 1 s on → 1 s off ...

 Time settings

Time for cyclical
transmission of feedback
telegram
Hours (0)..23

0...23

Depending on parameterization, the different active feedback telegrams of the actuator can transmit their state also cyclically to the bus.
The parameter "Time for cyclical transmission of the feedback telegram" generally defines the cycle time for all outputs.

Setting the hours of the cycle time.

Minutes (0...59)

0...2...59

Setting the minutes of the cycle time.

Seconds (10...59)

10...59

Setting the seconds of the cycle time.

Presetting: 2 minutes 10 seconds

Time for cyclical
transmission operating
hours
Hours (0...23)

0...23

Depending on parameterization, the operating hours counters of the outputs can also transmit their count cyclically to the bus.
The parameter "Time for cyclical transmission of the operating hours" generally defines the cycle time for all outputs.

Setting the hours of the cycle time.

Minutes (0...59)

0...59

Setting the minutes of the cycle time.

Seconds (10...59)



10...59

Setting the seconds of the cycle time.

Presetting:

23 hours 0 minutes 10 seconds

 Manual control

Manual control in case of bus voltage failure	disabled enabled	This parameter can be used for programming whether manual control is to be possible (enabled) or deactivated in case of bus voltage failure (bus voltage off).
Manual control during bus operation	disabled enabled	This parameter can be used for programming whether manual control is to be possible (enabled) or deactivated during bus operation (bus voltage on).
Disable function for manual control ?	yes no	Manual control can be disabled via the bus, even if it is already active. For this purpose, the disabling object can be enabled here.
Polarity of disable object for manual control	0 = enabled / 1 = disabled 1 = enabled / 0 = disabled	This parameter defines the polarity of the disabling object.  Only visible if the disabling function for manual control is enabled.  If the setting is "1 = enabled / 0 = disabled", the disabling function is active immediately on return of bus/mains voltage or after an ETS programming operation (object value "0").
Transmit manual control status ?	yes no	The current state of manual control can be transmitted to the bus via a separate status object, if bus voltage is available (setting: "yes").

Function and polarity of status object

0 = inactive;
1 = manual control active

This parameter defines the information contained in the status object. The object is always "0", when the manual control mode is deactivated.

The object is "1" when the manual control mode is active (temporary or permanent).

0 = inactive;
1 = permanent manual control active

The object is "1" only when the permanent manual control is active.

i This parameter is visible only if the manual control status transmission is enabled.

i The status will be actively transmitted to the bus ("0") after bus voltage return only if a manual control was terminated by such return of voltage.

Behaviour at the end of permanent manual control during bus mode

no change

The behaviour of the actuator at the end of permanent manual control depends on this parameter.

All telegrams received during an active permanent manual control mode for direct operation (switching, dimming, brightness value, scenes) will be discarded. After the end of the permanent manual control mode, the current state of all outputs remains unchanged. If, however, a Forced-control position or a disabling function was activated before or during the manual mode, the dimming actuator does not execute the reaction parameterized for this function in the outputs concerned.

track outputs

During an active permanent manual control all incoming telegrams are internally tracked. At the end of manual control, the outputs are adjusted in line with the command last received or the state existing before manual control.

 Ax - General (x = 1...4)

Type of connected load		This parameter defines the dimming principle for the output.
	universal (with automatic load detection)	After mains voltage return or after an ETS programming operation, the load is detected automatically. Depending on mains conditions, the detection procedure lasts up to 10 s. With incandescent lamps, the detection procedure is characterized by the lamp flashing twice briefly.
	electronic transformer (capacitive / phase cut-off)	The output is permanently set to the phase cut-off principle. There is no automatic load detection. Only electronic transformers or incandescent lamps may be connected to the outputs.
	conventional transformer (inductive / phase cut-on)	The output is permanently set to the phase cut-on principle. There is no automatic load detection. Only conventional transformers or incandescent lamps may be connected to the outputs.  The presetting of a dimming principle, i.e. the parameterization for electronic or inductive transformers, is of interest in case of problems with the automatic detection of the connected load (e.g. when special transformers for universal dimming from some manufacturers are used).
Basic brightness	level 1 level 2 level 3 (incandescent lamps) level 4 level 5 (standard halogen) level 6 level 7 level 8	This parameter is used for presetting the basic brightness (lowest dimming level – brightness value = "1") This feature permits an adaptation to the lamps used and to existing local conditions . Level 1 represents the lowest basic brightness.

Maximum brightness	basic brightness
	5 %
	10 %
	15 %
	20 %
	25 %
	30 %
	35 %
	40 %
	45 %
	50 %
	55 %
	60 %
	65 %
	70 %
	75 %
	80 %
	85 %
	90 %
	95 %
	100 % (maximum brightness)

This parameter defines the maximum brightness of the output. The parameterized value is not exceeded in any state of operation of the dimming actuator during bus control.

i If values exceeding the parameterized maximum brightness are received via the brightness value object or are preset by other functions of the dimming actuator, the actuator adjusts the output concerned to the maximum brightness value.

Behaviour after ETS programming

0 % switching off

The dimming actuator permits setting the brightness value after an ETS programming operation separately for each output.

The output is switched off.

basic brightness

The output is adjusted to the preset brightness value (observe parameterized maximum brightness).

- 5 %
- 10 %
- 15 %
- 20 %
- 25 %
- 30 %
- 35 %
- 40 %
- 45 %
- 50 %
- 55 %
- 60 %
- 65 %
- 70 %
- 75 %
- 80 %
- 85 %
- 90 %
- 95 %
- 100 %

no reaction

After an ETS programming operation, the output shows no reaction and remains at the currently adjusted brightness level or off.

i The behaviour specified in this parameter will be executed after each download of applications or parameters with the ETS. A simple download of the physical address alone or partial programming of only the group addresses has the effect that this parameter is disregarded and that the parameterized "Behaviour after bus or mains voltage return" will be executed instead.

i The parameterized behaviour will only be executed, if the mains voltage supply of the dimming actuator is on at the end of the programming operation.

Behaviour in case of bus
voltage failure

0 % switching off

basic brightness

5 %

10 %

15 %

20 %

25 %

30 %

35 %

40 %

45 %

50 %

55 %

60 %

65 %

70 %

75 %

80 %

85 %

90 %

95 %

100 %

no reaction

The dimming actuator permits setting the brightness value in case of bus voltage failure separately for each output.

The output is switched off.

The output is adjusted to the preset brightness value (observe parameterized maximum brightness!).

In case of bus voltage failure, the output shows no reaction and remains at the currently adjusted brightness level or off.

Behaviour after bus or
mains voltage return

0 % switching off

The dimming actuator permits setting the brightness value after bus voltage return separately for each output.

The output is switched off.

basic brightness
5 %...100 %

The output is adjusted to the preset brightness value (observe parameterized maximum brightness!).

**brightness value before bus
/ mains voltage failure**

After bus or mains voltage return, the brightness value last adjusted and internally stored before bus or mains voltage failure will be restored.

no reaction

After bus/mains voltage return, the output shows no reaction and remains at the currently adjusted brightness level or off.

activate staircase function

The Staircase function is activated after bus or mains voltage return independent of the "Switching" object. For this setting it is indispensable that the Staircase function has been enabled beforehand. If the Staircase function has not been enabled, this setting will produce no reaction after return of bus/mains voltage.

i Setting "brightness value before bus voltage failure": For restoring the brightness value before bus / mains voltage failure, the brightness values are stored permanently. Storage is only effected, if bus and mains voltage are present and if the mains voltage has been on for at least 20 s. Programming of an application or of parameters with ETS resets the internally stored switching state to "off – 0".

i Note that a forced-control position affecting the brightness level of an output may be active after bus voltage return.

Switch-on brightness

This parameter defines the brightness adjusted at the output after each switch-on via the "Switching" or the "Central function" object.

basic brightness

- 5 %
- 10 %
- 15 %
- 20 %
- 25 %
- 30 %
- 35 %
- 40 %
- 45 %
- 50 %
- 55 %
- 60 %
- 65 %
- 70 %
- 75 %
- 80 %
- 85 %
- 90 %
- 95 %
- 100 %**

After switch-on, the output is adjusted to the preset brightness value (observe parameterized maximum brightness!).

memory value (brightness prior th the last shut-off)

After switch-on, the output is adjusted to the brightness value that was active and internally stored before the last shut-off (via the "Switching" object. This memory value is stored non-permanently which means that after a mains voltage return or after an ETS programming operation the memory value is identical to the value of maximum brightness.

i If no soft-ON function is active, the output jumps to the brightness value after switch-on (direct approach).

<p>Dimming response to a brightness value</p>	<p>direct jump</p> <p>gradual dimming</p> <p>fading</p>	<p>This parameter defines whether a brightness value received via the bus (absolute dimming) is reached by direct approach or by gradual approach in line with the predefined dimming characteristic. Fading is available as an alternative mode. In the fading mode, the received brightness value is reached in exactly the parameterized time independently of the dimming characteristic and irrespective of the brightness level from which the dimming cycle was started. Several dimming outputs can thus be adjusted in such a way that they all reach the same brightness level at the same time.</p>
<p>Time for brightness value via fading seconds (0...59)</p>	<p>0...20...59</p>	<p>This parameter defines the fading time. A dimming cycle in the fading mode lasts exactly as long as specified in the parameter. A parameter setting of "0" causes the output to jump to the brightness value (direct approach).</p> <p><i>Presetting: 20 seconds</i></p> <p>i Only visible if "Dimming response to a brightness value = fading"</p>
<p>Assignment to central function ?</p>	<p>yes</p> <p>no</p>	<p>This parameter determines the assignment of the output to the central function.</p> <p>The output is assigned to the central function.</p> <p>The output is not assigned to the central function.</p> <p>i This parameter is visible only if the central function is enabled.</p>

 Ax – Enabled functions (x = 1...4)

Feedback telegrams	<p>disabled</p> <p>enabled</p>	<p>This parameter can be used to disable or to enable the feedback functions. When the functions are enabled, the required parameters are displayed under "Ax – Feedbacks".</p>
Time delays	<p>disabled</p> <p>enabled</p>	<p>This parameter can be used disable or to enable the time delays. When the function is enabled, the required parameters will be displayed under "Ax - Time delays</p>
Staircase function	<p>disabled</p> <p>enabled</p>	<p>This parameter can be used disable or to enable the Staircase function. When the function is enabled, the corresponding parameters will be displayed under "Ax - Staircase function" and the necessary objects enabled.</p>
ON/OFF switching behaviour	<p>disabled</p> <p>enabled</p>	<p>This parameter can be used to enable or to disable the functions influencing the switch-on/shut-off behaviour of the output. If the functions are enabled, the required parameters are displayed under "Ax – ON/OFF switching behaviour".</p>
Scene function	<p>disabled</p> <p>enabled</p>	<p>This parameter can be used disable or to enable the scene function. When the function is enabled, the corresponding parameters will be displayed under "Ax - Scenes" and the necessary objects enabled.</p>
Operating hours counter	<p>disabled</p> <p>enabled</p>	<p>This parameter can be used to disable or to enable the operating hours counter. When the function is enabled, the corresponding parameters will be displayed under "Ax - Operating hours counter" and the necessary object enabled.</p> <p> Disabling of the operating hours counter results in the deletion of any operating hours counted before for the output concerned!</p>

Report short-circuit / overload ?	yes no	This parameter can be used to enable the short-circuit and overload warning messages. After enabling, the corresponding communication object is displayed.
Report load failure ?	yes no	This parameter can be used to enable the load failure warning message. After enabling, the corresponding communication object is displayed.
Report load type ?	yes no	This parameter can be used to enable the load type information message. After enabling, the corresponding communication object is displayed.

Cyclical transmission of feedback telegram ?		The object value of the switching status feedback can be transmitted cyclically.
	yes (cyclical transmission and transmission in case of changes)	The feedback telegram is transmitted to the bus cyclically and after state changes. The cycle time is generally programmed under "Time settings" for all feedback telegrams.
	no (transmission only in case of changes)	The feedback telegram is transmitted to the bus only after updates of the state. <input type="checkbox"/> This parameter is only visible in case of an actively transmitting feedback object.
Brightness value feedback ?		The current brightness value of the output can be reported back to the bus separately.
	no feedback	No feedback object available for the output. Feedback deactivated.
	feedback object is active message object	Feedback and object are activated. The object transmits actively (telegram transmission after change).
	feedback object is passive status object	Feedback and object are activated. The object is passive (telegram transmission only as a response to 'Read' request). <input type="checkbox"/> The communication flags of the object are automatically set by the ETS according to the setting.
Time delay for feedback telegram after bus voltage return ?	yes	After bus or mains voltage return or after an ETS programming operation, the brightness value feedback telegram can be transmitted to the bus with a time delay. Setting "yes" activates the feedback delay. The delay time is parameterized on parameter page "General". <input type="checkbox"/> This parameter is only visible in case of an actively transmitting feedback object.
	no	

Cyclical transmission of
feedback telegram ?

The object value of the brightness value
feedback can be transmitted cyclically.

yes (cyclical transmission and
transmission in case of
changes)

The feedback telegram is transmitted to the
bus cyclically and after state changes. The
cycle time is generally programmed under
"Time settings" for all feedback telegrams.

**no (transmission only in
case of changes)**

The feedback telegram is transmitted to the
bus only after updates of the state.

i This parameter is only visible in case of
an actively transmitting feedback object.

 Ax – Time delays (x = 1...4 / only visible if the parameter "Time delays" on parameter page "Ax – Enabled functions" is set to "enabled").

Selection of time delay	<p>no time delay</p> <p>ON-delay</p> <p>OFF-delay</p> <p>ON-delay and OFF-delay</p>	<p>The "switching" communication object can be evaluated with a time delay. This parameter is used to define the desired mode of operation of the time delay and to enable the other delay parameters.</p>
ON-delay Minutes (0...59)	0...59	<p>This parameter is used for programming the duration of the ON-delay Sets the minutes of the ON-delay.</p>
Seconds (0...59)	0...10...59	<p>Sets the seconds of the ON-delay .</p> <p><i>Presetting: 20 seconds</i></p>
ON-delay retriggerable ?	<p>yes</p> <p>no</p>	<p>An active ON-delay can be retriggered by another "1" telegram (setting "yes"). Alternatively, retriggering can be excluded (setting "no").</p> <p> The ON-delay parameters are only visible when the ON-delay or when ON-delay and OFF-delay are activated.</p>
OFF delay Minutes (0...59)	0...59	<p>This parameter is used for programming the duration of the OFF-delay Sets the minutes of the OFF-delay.</p>
Seconds (0...59)	0...10...59	<p>Sets the minutes of the OFF-delay.</p> <p><i>Presetting: 20 seconds</i></p>

OFF-delay retriggerable yes
? **no**

An active OFF-delay can be retriggered by another "0" telegram (setting "yes"). Alternatively, retriggering can be excluded (setting "no").

i The OFF-delay parameters are only visible when the OFF-delay or when ON-delay and OFF-delay are activated.

Supplementary function for staircase function		<p>The Staircase function can be enlarged by two additional functions to be used alternatively. This parameter enables the desired additional function and activates the necessary parameters or objects.</p>
	no additional function	No supplementary function is enabled.
	time extension	Time extension is activated. This function permits retriggering an activated staircase lighting time n times via the object "Staircase function start/stop".
	time preset via the bus	Time preset via the bus is active. With this supplementary function, the parameterized ON-time can be multiplied with a factor received from the bus and thus dynamically adapted.
Max. time extension	1-fold 2-fold 3-fold 4-fold 5-fold	<p>In case of a time extension (retriggering the time n times via the object "Staircase function start/stop"), the parameterized ON-time will – after having elapsed – be extended at maximum by the value programmed in this parameter.</p> <p>1-fold extension means that the started staircase time can be automatically retriggered at maximum one more time after elapsing. The lighting time is thus doubled.</p> <p>The other setting options apply analogously.</p> <p>i This parameter is visible only when the supplementary function "Time extension" is active.</p>
Staircase function activatable via object 'Staircase function factor' ?	yes no	<p>In case of time preset via the bus, this parameter can be used to define whether the reception of a new time factor starts the ON-time of the staircase function as well. The object "Staircase function start/stop" is then hidden.</p> <p>When the setting is "no", the ON-time can only be activated via the object "Staircase function start/stop".</p> <p>i This parameter is visible only when the supplementary function "Time preset via the bus" is active.</p>

Activate pre-warning
time ?

When the ON-time of a staircase function has elapsed, the output can activate the pre-warning function (reduction of brightness). The pre-warning function is designed to warn a person in the staircase that the lights will go out shortly.

yes

The pre-warning function is activated.

no

The pre-warning function is deactivated.

Pre-warning time
Minutes (0...59)

0...59

This parameter is used for programming the duration of the pre-warning time. The pre-warning time is added to the ON-time. The lights are on with reduced brightness during the time specified in this parameter. Sets the minutes of the pre-warning time.

Seconds (0...59)

0...**30**...59

Sets the seconds of the pre-warning time.

Presetting: 30 seconds

 This parameter is visible only if the pre-warning time is enabled.





Reduced brightness during pre-warning time (1...100 %) 1 %...**50 %**...100 %

This parameter defines the reduced brightness selected for the pre-warning time.

i When the automatic shut-off function is being used: The reduced brightness of the pre-warning launches the shut-off function when reaching or when falling below the shut-off brightness level.

i This parameter is visible only if the pre-warning time is enabled.

 Ax – Switch-on/switch-off behaviour (x = 1...4 / only visible if the parameter "Switch-on/switch-off behaviour" on parameter page "Ax – Enabled functions" is set to "enabled").

Soft-ON function ?	yes no	The soft-ON function is used for slowing down the switch-on reaction of the output. If the function is activated (setting "yes"), a dimming cycle to the switch-on brightness is started on reception of a switch-on telegram via the "Switching" or the "Central function" object.
Time for dimming step soft-ON Seconds (0...59)	0...59	These parameters set the dimming step time for the soft-ON function. Sets the seconds of the dimming step time for soft-ON.
Milliseconds (1...99 x 10)	1...99	Sets the milliseconds of the dimming step time for soft-ON. <i>Presetting: 10 milliseconds</i>  The soft-ON time cannot be retrIGGERED.  The parameters of the soft-ON function are only visible, if the soft-ON function is enabled.
Soft-OFF function ?	yes no	The soft-OFF function is used for slowing down the shut-off reaction of the output. If the function is activated (setting "yes"), a dimming cycle to brightness "0 %" is started on reception of a switch-off telegram via the "Switching" or the "Central function" object.
Time for dimming step soft-OFF Seconds (0...59)	0...59	These parameters set the dimming step time for the soft-OFF function. Sets the seconds of the dimming step time for soft-OFF.
Milliseconds (1...99 x 10)	1...99	Sets the milliseconds of the dimming step time for soft-OFF. <i>Presetting: 10 milliseconds</i>  The soft-OFF time cannot be retrIGGERED.  The parameters of the soft-OFF function are only visible, if the soft-OFF function is enabled.

Automatic shutoff when falling below a specified brightness ?	<p>yes</p> <p>no</p>	<p>This parameter can be used for activating the automatic shut-off function for the output. If activated, the connected lamps are switched off completely when the brightness falls below a parameterized brightness at the end of a dimming cycle and, if applicable, after a delay has elapsed.</p>
Shutoff when brightness value smaller	<p>5 %</p> <p>10 %</p> <p>15 %</p> <p>20 %</p> <p>25 %</p> <p>30 %</p> <p>35 %</p> <p>40 %</p> <p>45 %</p> <p>50 %</p> <p>55 %</p> <p>60 %</p> <p>65 %</p> <p>70 %</p> <p>75 %</p> <p>80 %</p> <p>85 %</p> <p>90 %</p> <p>95 %</p> <p>100 %</p>	<p>This parameter defines the level at which – if the brightness falls below this level – the output is switched off at the end of the dimming cycle and, if applicable, after a programmed delay has elapsed.</p> <p>i If the shut-off brightness is no longer reached due to a disabling or forced-control position function, the shut-off function is not executed.</p> <p>i This parameter is visible only if the shut-off function is enabled.</p>
Delay until shutoff Hours (0...23)	0...23	<p>This parameter defines the delay of the shut-off function. When the brightness is below the shut-off level at the end of a dimming cycle, the output is switched on after the time preset in this parameter has elapsed. Sets the hours of the delay time.</p>
Minutes (0...59)	0...59	<p>Sets the minutes of the delay time.</p>
Seconds (0...59)	0...30...59	<p>Sets the seconds of the delay time.</p> <p><i>Presetting: 30 seconds</i></p> <p>i The parameters of the delay time are only visible, if the shut-off function is enabled.</p>



 Ax – Scenes (x = 1...4 / only visible if the parameter "Scenes" on parameter page "Ax – Enabled functions" is set to "enabled").

Delay scene recall ?	<p>yes</p> <p>no</p>	<p>A scene is recalled via the scene extension object. If needed, the scene recall can be made with a delay after reception of a recall telegram (setting: "yes"). The recall is alternatively made immediately on reception of the telegram (setting: "no").</p> <p>i A recall delay has no influence on the storage of scene values.</p>
Delay time Minutes (0...59) Minutes (0...59)	0...59	<p>This parameter defines the time delay for a scene recall.</p> <p>Sets the minutes of the delay time.</p>
Seconds (0...59)	0...10...59	<p>Sets the seconds of the delay time.</p> <p><i>Presetting: 10 seconds</i></p> <p>i The delay time parameters are only visible, if the parameter "Delay scene recall ?" is set to "yes".</p>
Response to a scene recall	<p>direct jump to brightness value</p> <p>gradual dimming to brightness value</p> <p>gradual dimming to brightness value by fading</p>	<p>When a scene is recalled, the output concerned is adjusted to the parameterized or stored scene brightness value. This parameter defines whether the brightness value is reached by direct approach, by gradual approach or by fading.</p> <p>In the fading mode, the brightness to be adjusted is reached in exactly the parameterized time independently of the dimming characteristic and irrespective of the brightness level from which the dimming cycle was started. Several dimming outputs can thus be adjusted in such a way that they all reach the same brightness level at the same time.</p>

<p>Dimming step time (0...255 ms)</p>	<p>0...5...255</p>	<p>Sets the dimming step time for the gradual approach to the brightness value.</p> <p>i This parameter is only visible, if the parameter "Behaviour after a scene recall" is set to "gradual approach to brightness value by dimming step time".</p>
<p>Fading time (0...240 s)</p>	<p>0...2...240</p>	<p>Sets the fading time when the brightness value of a scene is to be reached by fading.</p> <p>i This parameter is only visible, when the parameter "Behaviour after a scene recall" is set to "gradual approach to brightness value by fading".</p>
<p>Overwrite values stored in the device during download ?</p>	<p>yes no</p>	<p>When a scene is stored, the scene value of the output is stored internally in the device. To prevent the stored values from being replaced during ETS programming by the originally programmed scene values, the dimming actuator can inhibit overwriting of the scene values (setting: "no").</p> <p>As an alternative, the original values can be reloaded into the device during each ETS programming operation (setting: "yes").</p>
<p>Scene X activatable by scene number (scene number "0" = scene deactivated)</p> <p><i>X = depending on the scene (1...8)</i></p>	<p>1*...64</p> <p><i>*: The predefined scene number is dependent on the scene (1...8).</i></p>	<p>The actuator distinguishes between up to 8 different scenes which are recalled via the scene extension object or stored. The datapoint type of the extension object, however, permits addressing a maximum of 64 scenes.</p> <p>This parameter defines the scene number (1...64) which is used to address the internal scene (1...8).</p> <p>A setting of "0" deactivates the corresponding scene.</p>



<p>Brightness value for scene X</p> <p><i>X = depending on the scene (1...8)</i></p>	<p>0 % (switching off) basic brightness</p> <p>5 %</p> <p>10 %</p> <p>15 %</p> <p>20 %</p> <p>25 %</p> <p>30 %</p> <p>35 %</p> <p>40 %</p> <p>45 %</p> <p>50 %</p> <p>55 %</p> <p>60 %</p> <p>65 %</p> <p>70 %</p> <p>75 %</p> <p>80 %</p> <p>85 %</p> <p>90 %</p> <p>95 %</p> <p>100 %*</p> <p><i>*: The preset value is dependent on the scene (1...8).</i></p>	<p>This parameter defines the brightness adjusted when a scene is recalled.</p>
<p>Storage function for scene X</p> <p><i>X = depending on the scene (1...8)</i></p>	<p>yes</p> <p>no</p>	<p>Setting "yes" enables the storage function of the scene. If the function is enabled, the current brightness value can be stored internally via the extension object on reception of a storage telegram. If "no" is selected, the storage telegrams are discarded.</p>

 Ax – Operating hours counter (x = 1...4 / only visible if the parameter "Operating hours counter" on parameter page "Ax – Enabled functions" is set to "enabled").

Type of counter	<p>up-counter</p> <p>down-counter</p>	<p>The operating hours counter can be configured as an up-counter or as a down-counter. The setting has an influence on the visibility of the other parameters and objects of the operating hours counter.</p>
Limit value preset ?	<p>no</p> <p>yes, as specified in parameter</p> <p>yes, as received via object</p>	<p>If the up-counter is used, a limit value can be optionally preset. This parameter defines whether the limit value can be preset in a separate parameter or individually adapted from the bus by an independent communication object. A setting of "no" deactivates the limit value.</p> <p> This parameter is only visible in the configuration "Counter type = Up-counter".</p>
Limit value (1...65535 h)	1... 65535	<p>This parameter is used for setting the start value of the Up-counter. When this limit is reached, a "1" telegram is transmitted via the "End of counting" object. The counter continues to run until the max. count (65535) is reached and stops.</p> <p> This parameter is only visible, if the parameter "Limit value preset ?" is set to "yes, as specified in parameter".</p>
Start value preset ?	<p>no</p> <p>yes, as specified in parameter</p> <p>yes, as received via object</p>	<p>If the down-counter is used, a start value can be preset as an option. This parameter defines whether the start value can be preset in a separate parameter or individually adapted from the bus by an independent communication object. A setting of "no" deactivates the start value.</p> <p> This parameter is only visible in the configuration "Counter type = Down-counter".</p>

Start value (1...65535 h)	1... 65535	<p>This parameter is used for setting the start value of the Down-counter. After the initialization, the counter begins to decrement the hours from the preset value to "0". After reaching the final value, a "1" telegram is transmitted via the "End of counting" object.</p>
		<p>i This parameter is only visible, if the parameter "Start value preset ?" is set to "yes, as specified in parameter".</p>
Automatic transmission of counting value ?		
		<p>The current count of the operating hours counter can be actively transmitted to the bus via the communication object "Value operating hours counter".</p>
		<p>The count is transmitted to the bus cyclically and after updating. The cycle time is generally programmed for all outputs on the "Time settings" parameter page.</p>
		<p>The count is transmitted to the bus only after updating.</p>
		<p>cyclical transmission</p> <p>after change by interval value</p>
Counting value interval (1...65535 h)	1...65535	<p>This parameter is used for setting the counting value interval for automatic transmission. The current count will be transmitted to the bus after the time programmed in this parameter has elapsed.</p>
		<p>i This parameter is only visible, if the parameter "Limit value preset ?" is set to "yes, as specified in parameter".</p>

 Ax – Supplementary functions (x = 1...4 / only visible if the parameter "Supplementary functions" on parameter page "Ax – Enabled functions" is set to "enabled").

<p>Selection of supplementary function</p>	<p>no supplementary function</p> <p>disabling function</p> <p>forced-control position</p>	<p>This parameter can be used to define and to enable the supplementary function. The disabling function can only be parameterized as an alternative to the forced-control position function.</p>
<p>Polarity of disable object</p>	<p>0 = enabled; 1 = disabled</p> <p>0 = disabled; 1 = enabled</p>	<p>This parameter defines the polarity of the disabling object.</p> <p> After bus / mains voltage return or programming of the application or of the parameters with the ETS, the disabling function is always deactivated (object value "0"). In the inverted setting ("0 = enabled; 1 = disabled"), a "0" telegram update must first be sent after the initialization before the disabled state can be activated.</p> <p> This parameter is visible only if the disabling function is enabled.</p>

Behaviour at the beginning of the disabling function

The behaviour of the output at the beginning of the disabling function can be parameterized.

0 % (switching off)

The output is switched off at the beginning of disable and interlocked.

basic brightness
5 %...100 %

At the beginning of disable, the output is adjusted to the preset brightness value (observe parameterized maximum brightness!) and interlocked.

memory value (brightness before last shut-off)

At the beginning of disable, the output is adjusted to the brightness value that was active and internally stored before the last shut-off (via the "Switching" or the "Central function" object. This memory value is not stored permanently which means that this value preset to maximum brightness after a mains voltage return or after an ETS programming operation.

no reaction

At the beginning of disable, the output shows no reaction and remains at the currently adjusted brightness level or off. Thereafter, the output is interlocked.

blinking

The output is switched on and off during disable and is interlocked during this time. The blinking time is generally parameterized for all outputs on the "General" parameter page. During blinking, the logic switching state is "on - 1" and the brightness reported back is the switch-on brightness. Soft-ON / soft-OFF functions are disregarded during blinking.

- An output disabled via the bus can still be operated by hand on the dimming actuator itself.
- This parameter is visible only if the disabling function is enabled.

Behaviour at the end of the disabling function

The behaviour of the output at the end of the disabling function can be parameterized.

0 % (switching off)

The output is shut off at the end of disable and then re-enabled.

basic brightness
5 %...100 %

At the end of disable, the output is adjusted to the preset brightness value (observe parameterized maximum brightness!) and re-enabled.

memory value (brightness before last shut-off)

At the end of disable, the output is adjusted to the brightness value that was active and internally stored before the last shut-off (via the "Switching" or the "Central function" object. This memory value is not stored permanently which means that this value preset to maximum brightness after a mains voltage return or after an ETS programming operation.

tracked brightness value

At the end of disable, the state received during the disabling function or the state adjusted before the disabling function will be restored. Running time functions, if any, will also be considered.

no reaction

At the end of disable, the output shows no reaction and remains at the currently adjusted brightness level or off. Thereafter, bus operation of the output is again enabled.

blinking

At the end of disable, the output is again enabled for bus operation and starts blinking. The blinking time is generally parameterized for all outputs on the "General" parameter page. During blinking, the logic switching state is "on - 1" and the brightness reported back is the switch-on brightness. Soft-ON / soft-OFF functions are disregarded during blinking. The blinking state remains active until another bus command presetting another state is being received.

 This parameter is visible only if the disabling function is enabled.

Brightness for forced-control position
"active, ON"

basic brightness
5 %...**100 %**

memory value (brightness before last shut-off)

no reaction

If a forced-control position is activated and if forcing is "ON", this parameter can be used to fix the behaviour of the output.

The output is adjusted to the preset brightness value (observe parameterized maximum brightness!).

The output is adjusted to the brightness value that was active and internally stored before the last shut-off (via the "Switching" or the "Central function" object. This memory value is not stored permanently which means that after a mains voltage return or after an ETS programming operation the memory value is identical to the value of maximum brightness.

The output shows no reaction and remains at the currently adjusted brightness level or off.

 This parameter is visible only if the forced-control position function is enabled.

Brightness for forced-control position
"active, OFF"

0 % (switching off)

If a forced-control position is activated and if forcing is "OFF", the output is always shut off.

This parameter cannot be edited.

 This parameter is visible only if the forced-control position function is enabled.

Response at the end of
the forced-control
position function

no reaction

The behaviour of the output at the end of
the forced-control position function can be
programmed in this parameter.

At the end of forced-control position, the
output shows no reaction and remains at
the currently adjusted brightness level or
off. Thereafter, bus operation of the output
is again enabled.

tracked brightness value

At the end of forced-control position, the
state received during the disabling function
or the state adjusted before the disabling
function will be restored with the
corresponding brightness value. Running
time functions, if any, will also be
considered. Thereafter, bus operation of
the output is again enabled.

i This parameter is visible only if the
forced-control position function is
enabled.

Behaviour after bus
voltage return

The communication object of the forced-control position function can be initialized after bus voltage return. The switching state of the output can be influenced when the forced-control position function is activated.

no forced-control position

No forced-control position activated after bus voltage return.

activate forced-control
position, ON

Forced-control position activated. The output will be switched on with the brightness value defined by the parameter "Brightness for forced-control position active, ON" parameter.

activate forced-control
position, OFF

Forced-control position activated. The output will be shut off by Forced-control position.

state of forced-control as
before bus voltage failure

The state of the forced-control position will be restored on bus voltage return as it was stored permanently at the time of a bus or mains voltage failure. After programming of the application or of the parameters with the ETS, the value is internally set to "not active".

In case of active forcing, the output will be switched on with the brightness value defined by the "Brightness for forced-control position active, ON" parameter.

i After programming of the application or of the parameters with the ETS, the forced-control position is always deleted.

i This parameter is visible only if the forced-control position function is enabled.

 Ax – Dimming characteristic (x = 1...4)

Nature of dimming characteristic

This parameter can be used for setting dimming characteristics of the output. This feature permits adapting the device to the lamps used and to the subjective sensation of brightness by the human eye.

linear

The brightness characteristic between basic brightness and 100 % is linear.

adapted to incandescent lamps

The characteristic is adapted to incandescent lamps.

adapted to halogen lamps

The characteristic is adapted to halogen lamps.

user-defined

The brightness characteristic between basic brightness and 100 % can be adapted to individual requirements. For this purpose, the brightness range is divided into up to three sub-ranges. Each sub-range can be configured with an independent dimming speed.

Time between two dimming steps (1...255 ms)

1...**10**...255

This parameter sets the dimming step speed (time between two brightness values) for a linear characteristic.

 Visible only if "Characteristics = linear"

Range 1
Time between two dimming steps (1...255 ms)

1...**20**...255

This parameter sets the dimming step speed (time between two brightness values) of the first sub-range for user-defined characteristics.

 Visible only if "Characteristics = user-defined"

<p>Brightness value limit 1st range / 2nd range (1...100 %)</p>	<p>1...20...100</p>	<p>This parameter defines the first brightness limit value. This limit value fixes the limit between the first and the second sub-range.</p>
		<p><input type="checkbox"/> Visible only if "Characteristics = user-defined"</p>
<p>Range 2: Time between two dimming steps (1...255 ms)</p>	<p>1...10...255</p>	<p>This parameter sets the dimming step speed (time between two brightness values) of the second sub-range for user-defined characteristics.</p>
		<p><input type="checkbox"/> Visible only if "Characteristics = user-defined"</p>
<p>Brightness value limit 2nd range / 3rd range (1...100 %)</p>	<p>1...80...100</p>	<p>This parameter defines the second brightness limit value. This limit value fixes the limit between the second and the third sub-range.</p>
		<p><input type="checkbox"/> The brightness value specified must be greater than the first brightness limit value. Otherwise, risk of malfunction.</p>
		<p><input type="checkbox"/> Visible only if "Characteristics = user-defined"</p>
<p>Range 3: Time between two dimming steps (1...255 ms)</p>	<p>1...5...255</p>	<p>This parameter sets the dimming step speed (time between two brightness values) of the third sub-range for user-defined characteristics.</p>
		<p><input type="checkbox"/> Visible only if "Characteristics = user-defined"</p>

Actuators

Dimming Control Unit 1 — 10 V, 2-gang

1

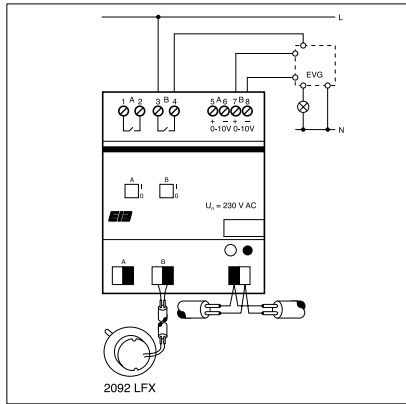

2

	Ref.-No.
KNX control unit 1 – 10 V, 2-gang	2092 REG X
ETS-product family:	Illumination
Product type:	Dimmer
Series embodiment (SE)-device (4 units)	

3

The dimming actuator receives telegrams for switching or dimming two groups of fluorescent lamps together with an electronic lamp ballast with 1 – 10 V interface (ELB-dynamic-type).
 The dimming signal is controlled by a 1 – 10 V interface input. Depending on the parameter it is possible to activate additional functions. Together with the accessory light sensor (ref.-no. 2092 LFX) the device can be used for a constant light control.
 The control unit is a passive device which needs an active signal supplied by the 1 – 10 V input.

ATTENTION: The min. version of the ETS must be at least ETS 2 Version 1.1/Service release B!
 Non-observance causes heavy software damages, the device cannot be programmed.

4

Technical data

Supply	
Voltage:	24 V DC (+6 V / –4 V)
Power consumption:	max. 150 mW
Connection:	KNX connection block
Input	
Number:	2 (configured for light sensor 2092 LFX)
Range:	200 ... 1200 Lux
Output	
Number:	2
Signal voltage:	1 – 10 V
Signal current:	dependent on type of ballast (e.g. 1 Siemens EVC: 1 mA) max. 30 mA
Connection:	clamp bar
Length of wire:	max. 100 m
Performance:	2 make-contact
Rated voltage:	230 V AC
Rated current:	16 A (ohmic load), dependent on ballast
Connection:	clamp bar
Protection:	IP 20
Operation temperature:	–5°C ... +45°C
Storage temperature:	–25°C ... +55°C
Mounting:	on DIN rail 35 x 7.5

5 Description of application Control unit 301302

Description of software application:

- Switching and dimming behaviour adjustable by parameters.
- Dimming range can be restricted by a lower and upper limit value.
- Transmission of actual brightness value via the brightness value object.
- Transmission of actual switch status (0 or 1) via switch object and parameter „after switching ON/OFF object 0 sends its status“. That function is used to control the status LED in the push-button.
- Switching ON by switching or dimming object or only by switching object adjustable.
- Dimming to or jumping to brightness value.
- Behaviour on bus voltage drop/recovery adjustable.

The control unit switches or dims (via a 1 – 10 V control voltage) in dependance of the telegrams received via the KNX.

After receiving a switch ON telegram the max. brightness will be adjusted. The initial brightness, dimming speed as well as the dimming speed to a brightness value can be adjusted by parameter.

The current brightness value can be read out (e.g. by a push-button in order to store a light scene). For that purpose the R-flag of object 4/5 must be set in one device per group.

Furthermore, there is a parameter to select if the control unit shall be switched off by receiving a telegram with the brightness value = 0.

Additionally, the control unit switches OFF automatically if the brightness value falls below the adjusted setpoint.

This application is recommended for constant light controls with fluorescent lamps.

Constant light control:

When the device is configured as "Controller and dimmer", the control unit works in a constant light control operation. The actual brightness value is evaluated via the special light sensor (ref.-no. 2092 LFX).

In that operation mode an additional object and parameters are visible. Generally, there are two different control methods:

1. The brightness setpoint is fixed and cannot be changed by the user.
2. The brightness setpoint can be changed by the user with the parameter "dim brighter/darker...used as a new setpoint". That new setpoint is active until the next switch command is transmitted.

Adjustment of the light sensor:

1. Avoid natural light, only the artificial light has to be adjusted to the desired value by dimming commands.
2. A telegram with the value "1" has to be transmitted to the object 6/7.
3. The brightness value measured by the light sensor is the new setpoint.
4. For testing dimm down the lighting, the control unit will dimm up to adjust the new setpoint.

Additional dimming actuators can be triggered on by the 1 Byte objects 4/5. The control unit will transmit the brightness value via these objects.

Now also other dimming actuators such as leading/trailing edge control dimmer can be integrated into the constant light control.

Objects

Number of addresses (dynamic):	18
Number of assignments (dynamic):	18
Communication objects:	8

Object	Name	Function	Type	Flag
0	Switching	Channel A	1 Bit	W, C, T
1	Switching	Channel B	1 Bit	W, C, T
2	Dimming	Channel A	4 Bit	W, C
3	Dimming	Channel B	4 Bit	W, C
4	Brightness value	Channel A	1 Byte	W, C, T, (R)
5	Brightness value	Channel B	1 Byte	W, C, T, (R)
With constant light control operation additionally				
6	Setpoint value	Channel A	1 Bit	W, C
7	Setpoint value	Channel B	1 Bit	W, C

Actuators

Dimming

1

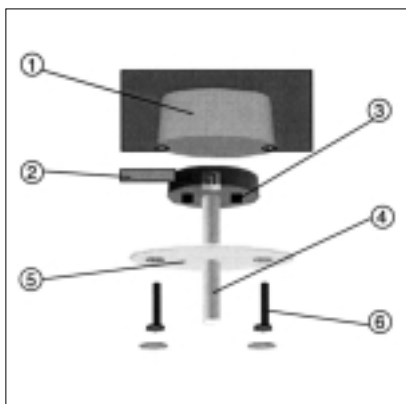

- 1 = Flush mounted wall box
- 2 = 2 wire cable
- 3 = Adhesive sticks
- 4 = Plastic stick (flat or angled)
- 5 = Cover
- 6 = Screws for cover

2

	Ref.-No.
Light sensor for control unit	
1 - 10 V (2092 REG X)	2092 LFX
Flush mounted device	
(No KNX device)	

3

Together with the control unit 2092 REG X the light sensor is used for a constant light control. It evaluates the brightness value in closed rooms. The sensor has to be installed in a flush mounted box mounted in the ceiling. The device is connected via a 2 wire cable and a max. length of 100 m. The light sensor is delivered with two different plastic sticks for different detection areas.

4

Technical data

Supply:	SELV via 2092 REG X
Connection:	on terminals of 2092 REG X
Protection:	IP 20
Operation temperature:	+5°C ... +45°C
Mounting:	fitted in wall box 60 mm
Length of wire:	max. 100 m
Dimensions:	54 x 10 mm (Ø x H)

Installation notes

The location of the sensor is strongly dependent on the rooms:

- avoid direct light from windows, lamps, mirrors, etc.
- install the light sensor as far from the windows as possible
- the detection area of the sensor should be pointed to an area which keeps a constant condition
- when the angled plastic stick is used, the angled side should be turned to the window side

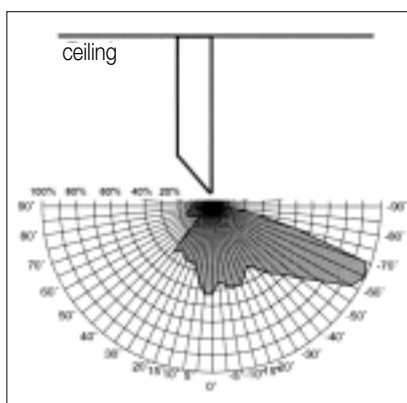
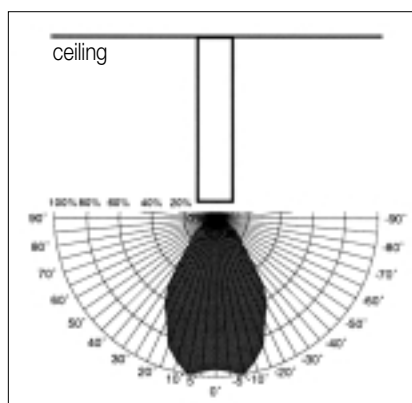

Actuators

Dimming Control unit 1 – 10 V, 3-gang

1

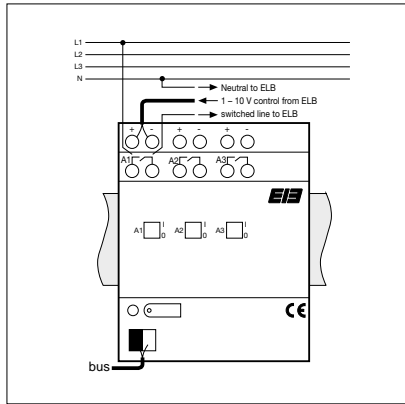
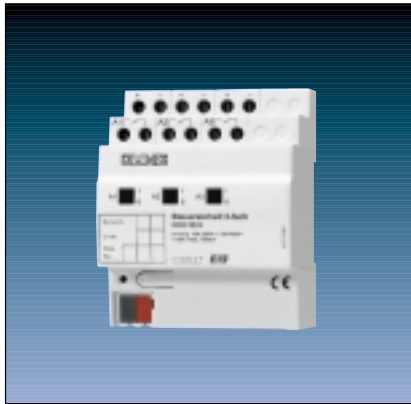

2

	Ref.-No.
KNX control unit, 3-gang	2193 REG
ETS-product family:	Illumination
Product type:	Dimmer
Series embodiment (SE)-device (4 units)	

3

The control unit receives telegrams for switching or dimming fluorescent lamps operated with an electronic ballast (ELB dynamic-type). The dimming signal is controlled by a 1 – 10 V interface input. Switching is effected by a relay contact that switches the ballast's voltage supply ON and OFF. This contact can also be actuated manually without any effect on the bus by 3 hardware slide switches.

4

Technical data

Supply	
Voltage:	24 V DC (+6 V / -4 V)
Power consumption:	max. 240 mW
Connection:	KNX connection block
Input	
Number:	3
Signal voltage:	1 – 10 V
Signal current:	max. 100 mA per channel dependent on type of ballast (e.g. 1 INSTA ELB: 0.8 mA, Siemens ELB: 1 mA)
Performance:	Power MOS-FET, trailing edge or leading edge
Rated voltage:	230 V AC \pm 10 %, 50/60 Hz
Rated current:	2 x 1.1 A
Connection:	clamp bar
Length of wire:	max. 500 m at 0.5 mm ²
Output	
Number:	3
Performance:	3 make-contact, floating point
Rated voltage:	230 V AC \pm 10 %, 50 Hz
Rated current:	16 A (ohmic load), dependent on the fluorescent lamps
Capacity:	2500 W ohmic load 1100 W / 140 μ F capacitive load dependent on the ballast due to different inrush currents: i.e. max. 15 INSTA ELB TC 1 – 10 V (single tube) max. 12 INSTA ELB TC 1 – 10 V (double tube)
Connection:	clamp bar
Protection:	IP 20

4 Technical data

Behaviour at voltage drop only bus voltage:	1 – 10 V input controls a connected voltage to 10 V, relay switches off
only mains:	the connected voltage to input 1 – 10 V is undefined, status of relay keeps value before voltage drop
bus and mains:	the connected voltage to input 1 – 10 V is undefined relay switches off
Behaviour at voltage recovery only bus voltage:	dependent on parameters
only mains:	control unit controls brightness according to object value
bus and mains:	dependent on parameters
Operation temperature:	-5°C ... +45°C
Storage temperature:	-25°C ... +70°C
Mounting:	on DIN rail 35 x 7.5

Notes:

- Different lines can be connected to the device.
- A manual switching by the slide switches is not detected by the software ! If a channel is blocked via bus, it can be switched by the slide switch.

Description of software application:

- Switching and dimming behaviour adjustable by parameters.
- Acknowledge for switching status by special objects.
- Transmission of actual brightness value via the brightness value object (set T-flag!).
- Soft-ON, soft-OFF and delayed dimming adjustable by parameters.
- Dimming to or jumping to brightness value.
- Light scene operation possibility (up to eight different saved values can be recalled as a light scene) → no special light scene push-button necessary !
- Blocking operation by special object with parameterised brightness value on start and end of blocking.
- Behaviour on bus voltage recovery adjustable.

Objects

Number of addresses:	27
Number of assignments:	27
Communication objects:	18

Object	Name	Function	Type	Flag
0	Output 1	Switching	1 Bit	C, W, (R)
1	Output 2	Switching	1 Bit	C, W, (R)
2	Output 3	Switching	1 Bit	C, W, (R)
3	Output 1	Dimming	4 Bit	C, W, (R)
4	Output 2	Dimming	4 Bit	C, W, (R)
5	Output 3	Dimming	4 Bit	C, W, (R)
6	Output 1	Brightness value	1 Byte	C, W, (R), (T)
7	Output 2	Brightness value	1 Byte	C, W, (R), (T)
8	Output 3	Brightness value	1 Byte	C, W, (R), (T)
9	Output 1	Acknowledge	1 Bit	C, W, (R)
10	Output 2	Acknowledge	1 Bit	C, W, (R)
11	Output 3	Acknowledge	1 Bit	C, W, (R)
12	Output 1	Blocking	1 Bit	C, W, (R)
13	Output 2	Blocking	1 Bit	C, W, (R)
14	Output 3	Blocking	1 Bit	C, W, (R)
15	Output 1	Light scene extension input	1 Byte	C, W, (R)
16	Output 2	Light scene extension input	1 Byte	C, W, (R)
17	Output 3	Light scene extension input	1 Byte	C, W, (R)

Objects marked with (R): Object value can be read out (set R-flag!)

Objects marked with (T): The actual brightness value is transmitted automatically to the bus (set T-flag!).

5

Notes to software application:

- Blocking function

Each channel of the control unit can be blocked via the bus while the actual brightness value is saved and kept constantly. A certain brightness value can be adjusted by parameters at start and end of blocking.

- Brightness value object

The actual brightness value is adjusted automatically in the brightness value objects. By setting the R-flag the actual value can be read out. By setting the T-flag the actual brightness value can be transmitted to the bus.

- Acknowledge of switching status

When the switch status of the control unit is changed from OFF to ON, or from ON to OFF, a corresponding switch telegram is transmitted to the bus via the acknowledge object. Also during a change from OFF to OFF or ON to ON the corresponding acknowledge telegram is transmitted. During a soft-ON function the acknowledge is transmitted at the start of the dimming process, whereby with an activated soft-OFF function the corresponding acknowledge is transmitted at the end of the dimming process.

Actuators

Heating Valve Drive

1



2

	Ref.-No.
KNX valve drive	2176 SV
ETS-product family:	Heating, A/C, ventilation
Product type:	Valve

3

The KNX valve drive is connected directly to the KNX without an additional bus coupling unit. An external power supply is also not necessary, the valve is supplied by the bus. The physical address has to be set with a magnet instead of a programming push-button. Together with the steady controlled temperature sensor 2178 or RCD, the valve receives a 8 bit regulation variable, resulting in 256 positions of the valve. The valve is suitable to be mounted to all thermostat valve bottoms for temperature regulation with e.g. radiators, floor heating, convectors etc. It offers two additional potential free inputs where e.g. window-contacts can be connected. The inputs also can be used to connect conventional push-buttons or switches which can act directly on the valve drive or can be used for any other KNX functions.

Note: Before use, check the valve bottom parts!

4

Technical data

Supply	
Voltage:	24 V DC (+6 V / -4 V)
Power consumption:	max. 240 mW (max. 12 mA at 20 V)
Connection:	KNX connection block via prepared connection pipe (1m (J)EYY-OB 3 x 2 x 0.6)
Input	
Number:	2
Signal voltage:	20 V impulses, duration approx. 3 ms
Signal current:	approx. 1 mA per channel
Output	
Number:	1
Stroke:	max. 4.5 mm
Run time:	25 s/mm
Connection:	to be put onto the valve bottom with gentle pressure and fixed with a suitable pliers.
Protection:	IP 44 (vertically mounted)
Behavior at bus voltage drop:	valve drive stops in its last position
recovery:	the valve drive runs through an adjustment routine and afterwards drives into the parameterized control variable. Inputs will be read out and sent to the bus, depending on parameters.
Operation temperature:	0°C ... +50°C
Storage temperature:	-20°C ... +70°C
Mounting:	screwed onto valve bottom parts from Heimeier (other bottom parts have to be checked)

4 Technical data

Note:

The valve drive is suited for Heimeier valve bottom parts and, in combination with the corresponding KNX room temperature sensors or RCD's, it makes optimal controlling results with high exactness possible.

In the initial operation phase the valve drive recognizes the position of the lifting valve in the closed and fully open position by its adjustment routine. Afterwards, the 8 Bit control variable received via the KNX, will be allocated to the effective valve motion in a linear relation. From this results the high suspension of the valve motion in 256 positions. After a given number of position changing (4000) and after each bus voltage drop, the valve starts the adjustment routine automatically.

5 Description of software application:

The KNX valve drive receives a valve control variable signal as a 1 byte telegram, demand orientated or cyclically, from the room temperature sensor RCD or via the KNX. According to the received control variable (0 – 100 %), the valve drives the valve bottom part into a position between 'closed' and 'max. open'.

The parameter 'flashing of programming LED, should a drive fault occur?' activates an optical signal at the valve drive.

In the normal operation mode, the position of the valve bottom part can be read out at any time by a 1 Byte telegram. Using the 1 Bit forced position object, the valve drive can be driven into a parameterised position. In this case the control variable input of the room temperature sensor or RCD is without influence.

This can be realized with window or door contacts to avoid the loss of heating or cooling energy. A '0'-telegram resets this object from the forced position and the valve returns to the last received control value.

Objects

Number of addresses:	12
Number of assignments:	12
Communication objects:	12

Object	Name	Function	Type	Flag
0	Control variable	Input	1 Bit/1Byte	C, W, T
1	Control variable	Real position	1 Byte	C, W, R
2	Status	Operating condition	1 Bit/1Byte	C, W, R
3	Forced position 1	Input	1 Bit	C, W, T
4	Forced position 2	Input	1 Bit	C, W, T
5	Min. limit	Input	1 Bit	C, W
6	Max. limit	Input	1 Bit	C, W
7	Binary input 1	*	1 Bit/1Byte	C, W, (R), (T)
8	Binary input 1	*	1 Bit/4 Bit	C, W, (R), (T)
9	Binary input 2	*	1 Bit/1Byte	C, W, (R)
10	Binary input 2	*	1 Bit/4 Bit	C, W, (R)
11	Limiting value	*	1 Bit/1Byte	C, W, (R)

Actuators

Heating Actuator

1



2

	Ref.-No.
KNX heating actuator,	
6-gang, 0,05 A	2136 REG HZ
ETS-product family:	Output
Product type:	6-gang binary output
Series embodiment (SE)-device (4 units)	

3

The heating actuator 6-gang serves to control electro-thermal valve drives for heating applications or cooling ceilings. It offers six electronic outputs which, depending on the KNX telegrams, allow the noiseless control of valve drives. Up to four electro-thermal valve drives (e.g. make Heimeier 1835, Sauter MTX 116F200, Möhlenhoff AA2001-00-1) can be connected to each output. The outputs are either switched or controlled by a PWM-signal (Pulse Width Modulation) on a continuous PI-regulation, depending on the adjusted set value (1 Bit or 8 Bit). The actuator is able to detect any overload or short circuit at its outputs. In this case the short circuited outputs will be permanently deactivated after an identification time. It is also possible to send an overload report to the bus. Via a separate object it can be toggled between summer and winter time operation. Additionally, each output can be driven to a forced position in order to send a parameterised set value to the output by a separate object.

4

Technical data

Supply	
Voltage:	24 V DC (+6 V / -4 V)
Power consumption:	typical 125 mW
Connection:	KNX connection block
Output	
Number:	6
Performance:	6 electronic (Triac) outputs
Rated voltage:	230 – 240 V AC
Rated current:	50 mA ohmic load per output
Connection:	screw terminals: 0.2 – 4 mm ²
Protection:	IP 20
Operation temperature:	-5°C ... +45°C
Storage temperature:	-25°C ... +70°C
Mounting:	on DIN rail 35 x 7.5

Note: To avoid an overload detection, the outputs never switch simultaneously.

5

Description of software application:

- 6 independent outputs, 1 Bit or 1 Byte
- 1 Byte set values to control via PWM-signal. The cycle time of the output signals can be parameterised.
- Status acknowledge of each output (1 Bit or 1 Byte) automatically or on request.
- Preferred valve position in case of bus voltage drop or recovery adjustable.
- Short circuit or overload report via separate objects per output.
- Acknowledge object can be inverted.
- Cyclical monitoring time of the set value of each output adjustable.
- Summer or winter time operation adjustable via object.
- Emergency operation after detection of mechanical malfunction.
- Behaviour at bus voltage drop/recovery adjustable.

Objects

Number of addresses:	29
Number of assignments:	29
Communication objects:	29

Object	Name	Function	Type	Flag
Set values:				
0 – 5	Output 1 – 6	Set value	1 Bit	C, W, (R)
0 – 5	Output 1 – 6	Set value	1 Byte	C, W, (R)
Status set values:				
6 – 11	Output 1 – 6	Status set value	1 Bit	C, T, (R)*
6 – 11	Output 1 – 6	Status set value	1 Bit	C, R*
6 – 11	Output 1 – 6	Status set value	1 Byte	C, T, (R)*
6 – 11	Output 1 – 6	Status set value	1 Byte	C, R*
12 – 17	Output 1 – 6	Forced position	1 Bit	C, W, (R)
18 – 23	Output 1 – 6	Overload/short circuit	1 Bit	C, W, (R)
24	Power failure	Alarm message	1 Bit	C, T, (R)
25	All valves closed	Status valves	1 Bit	C, T, (R)
26	Cycl. monitoring	Alarm message	1 Bit	C, T, (R)
27	Summer/winter	Switch over	1 Bit	C, W, (R)
28	Highest set value	ACK set value	1 Bit	C, T, (R)

Objects marked with (R): Object value can be read out (set R-flag!).

Objects marked with *: Dependent on the parameter „transmit status of valve position“ the status of a control variable is sent automatically (set T-flag), or only if requested by a telegram (set R-flag).

Displaying – Reporting

LCD Info Display

1

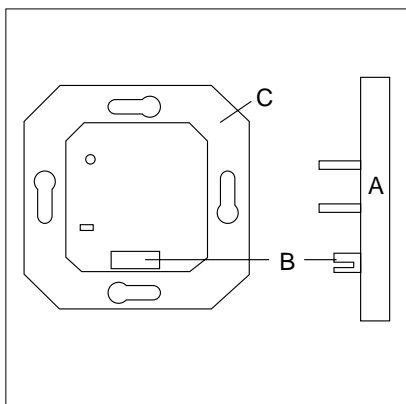
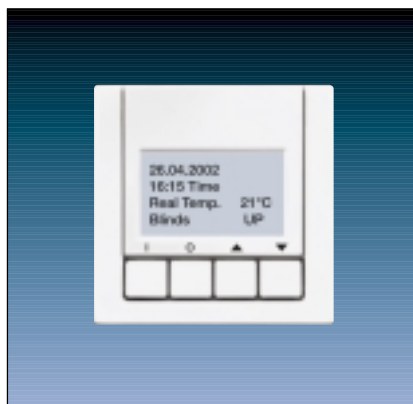

A: Application module (AM)
 B: Application interface (AI)
 C: Bus coupling unit (BCU)

2

	Ref.-No.
KNX LCD Info Display	
ETS-product family:	Display
Product type:	Display
ranges CD 500/CD plus	
ivory	2041
white	CD 2041 WW
blue	CD 2041 BL
brown	CD 2041 BR
grey	CD 2041 GR
light grey	CD 2041 LG
black	CD 2041 SW
ranges LS 990/LS plus, Stainless Steel, Aluminium, Chrome	
ivory	LS 2041
white	LS 2041 WW
light-grey	LS 2041 LG
stainless steel	ES 2041
aluminium (laquered)	AL 2041
anthracite	AL 2041 AN
gold coloured	GO 2041
chrome	GCR 2041

3

The LCD Info Display receives telegrams by the KNX and offers the possibility of a visual indication (LCD display) of free programmable text and values.

Up to 12 pages with 1, 2 or 4 lines can be defined. To each line one function (as switching, dimming, value indication, etc.) can be assigned.

On an additional alarm page up to 12 alarm messages can be administrated. To each alarm message, different alarm options as i.e. acoustic signal can be defined.

Note: For the programming of the device it is required to use at least the ETS 2 version 1.2a !

4 Technical data

Supply	
Voltage:	24 V DC (+6 V / -4 V) via BCU
Power consumption:	max. 150 mW
Connection:	2 x 5-pole pin bar
Display:	4 lines → 16 characters
	2 lines → 8characters
	1 line → 4 characters
Operation elements:	4 push-buttons
Text memory:	max. 12 pages, each with 4 lines à 16 characters
Acoustic signal:	2 tones, can be confirmed
Protection:	IP 20
Operation temperature:	0°C ... +45°C
Storage temperature:	-25°C ... +70°C
Mounting:	plugged on a flush mounted BCU

Description of the software:

The Info Display has a special software which is embedded into the ETS. By opening the parameters that software starts automatically and the display can be configurated.

During the installation of the software it is important to select the directory where the corresponding ETS is located. Additionally, a vd2 data base file has to be installed somewhere on the PC. Now the data base can be imported as usual within the ETS module.

The software and the software manual can be downloaded from our web-page.

Commissioning note:

The physical address of the BCU is programmed by the ETS. Before the download of the Info Display software application to the application module, the device itself has to be plugged onto the BCU.

When an ETS project with an Info Display has to be exported and imported into another PC, please ensure that the software is also installed on the target PC!

Displaying – Reporting

LCD Mini Panel

1

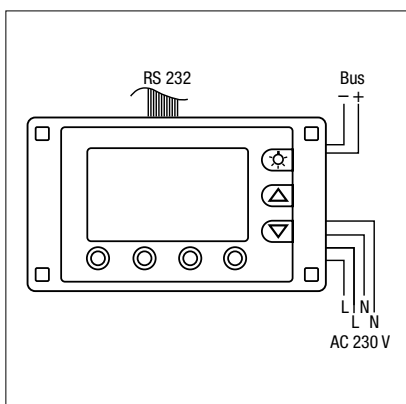

2

	Ref.-No.
LCD mini panel	MT 701
ETS-product family:	Display
Product type:	LCD display

3

The mini panel was developed as an extension of the product group of signal and operator panels, in order to control current building states from a central position and be able to influence functions. Due to its small flat design and scope of functions, the mini panel is intended for home and office applications.

The freely programmable LC graphic display can display up to 8 lines simultaneously while up to 16 elements can be arranged in two columns. The operation is interactive using sealed keypad.

As the user menu is freely programmable, it is possible to form functional groups that are individually matched to the building and which provide a clear representation of the various applications. Detailed functions can be displayed and operated via sub-menus. Up to 50 pages (25 pages while using the display in two columns) can be designed. It is also possible to integrate plan drawings, logos, general bitmaps etc. (240x128 pixel).

When configuring the mini panel, the menus and sub-menus can be set up as required and various KNX functions can be assigned.

Standard functions such as switching, dimming, shutter control and display of measured values can also be configured.

The formation of limiting values (up to 16) is also possible.

An internal real time clock is available for the execution of time functions (16 channel with 8 switching times per channel).

Furthermore, a complete light scene control is integrated, up to 32 lighting groups in up to 24 different light scenes can be assigned.

Within the different light scenes it is possible to activate or deactivate specific lighting groups. Hence, the device can be used to generate different independent light scene controls.

Up to 50 failure/alarm messages can be defined and up to 20 can be displayed simultaneously. All the messages are recorded in a listing within the system window and contains the last 100 entries.

The system page offers a password protection. The group addresses can be handled with "drag & drop". Internally up to 2000 group addresses can be handled.

The software allows the programming via the bus as well as with the RS232 interface.

Due to the slow transmission rate, it is recommended to use the programming via KNX just for changing of parameters/functions, not for the complete download of the application.

Furthermore, the software offers a preview monitor (simulation screen) where the current programming can be checked with interactive push-buttons. A resource monitor displays the current running capacity.

Finally, an internal powerful logic module is integrated which offers up to 80 logic links, 12 multiplexers (ideal for a partition wall application) as well as up to 40 filter timer elements.

Hence, additional hardware costs can be reduced.

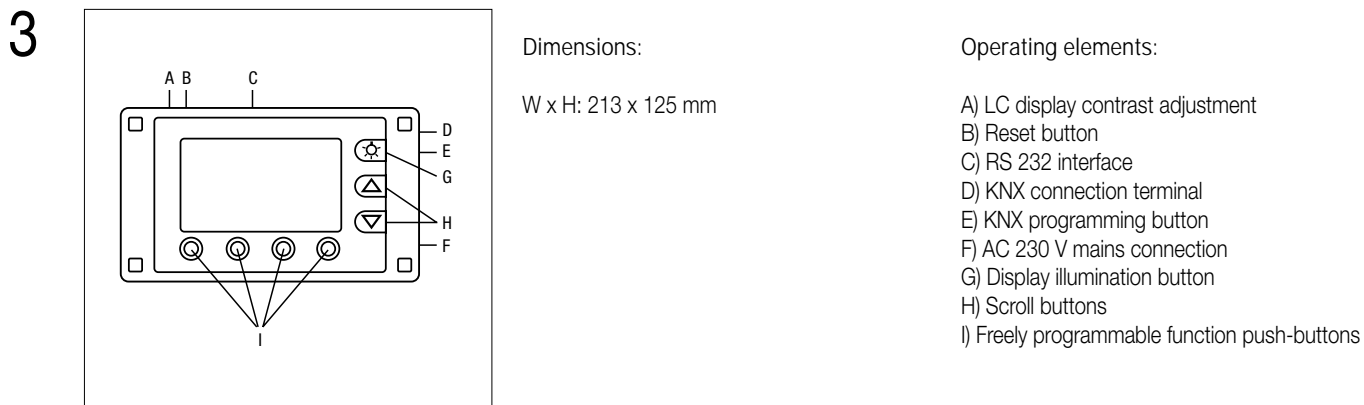

Note: The LCD mini panel comes without design frame and flush-mounted wall box !

5 Description of the software:

The LCD mini panel has a special software which is embedded into the ETS. By opening the parameters that software starts automatically and the panel can be configurated.

During the installation of the software it is important to select the directory where the corresponding ETS is located. Additionally, a vd2 data base file has to be installed somewhere on the PC. Now the data base can be imported as usual within the ETS.

When an ETS project of a MT 701 has to be exported and imported into another PC, please ensure that the software is also installed on the target PC!

The software and the software manual can be downloaded from our web-page.

An additional update tool for existing EIBTAB projects is available. Hence, it is possible to download the already existing project of an old LCD panel (ref.-no. 2425) into the MT 701 panel.

Displaying – Reporting

Colour Touch Panel

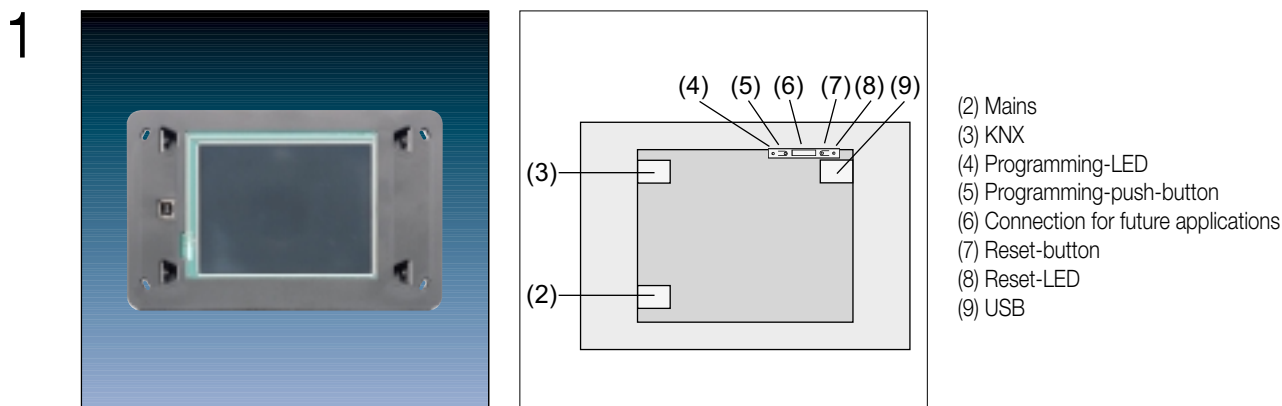

2

	Ref.-No.
Colour touch panel	FP 701 CT
ETS-product family:	Display
Product type:	LCD display

3 The innovative touch panel puts the user in the position of being able to monitor and regulate the complete sequences involved in the management of lighting, blinds and roller shutters, heating and air-conditioning systems, alarm systems, signalling devices and audio components, all conveniently from a single location. And indeed with navigation via a 5.7" TFT touch screen with a brilliant resolution of 4096 colours and 320 x 240 pixels, whereby 8 colour schemes are available for selection.

In addition to an accurate rendition of images and text, the monitor offers sufficient space to depict an individual background – in the form of photos, graphics or ground plans. The user interface can moreover be further optimised by retrieving drawings or flow charts for example onto the screen. There is also the possibility of linking up to 50 standard pages as required and accessing them directly. This clearly simplifies navigation and scrolling via the menus. All together up to 400 different display elements can be assigned on the different pages. The programming of the panel is carried out via the KNX or via the USB interface behind the frame which can be accessed from the front without any problems. When configuring the mini panel, the menus and sub-menus can be set up as required and various KNX functions can be assigned. Standard functions such as switching, dimming, shutter control and display of measured values can also be configured. The formation of limiting values (up to 16) is also possible.

An internal real time clock is available for the execution of time functions (16 channel with 8 switching times per channel).

Furthermore, a complete light scene control is integrated, up to 32 lighting groups in up to 24 different light scenes can be assigned.

Within the different light scenes it is possible to activate or deactivate specific lighting groups. Hence, the device can be used to generate different independent light scene controls.

Up to 50 failure/alarm messages can be defined and up to 20 can be displayed simultaneously. All the messages are recorded in a listing within the system window and contains the last 100 entries.

The system page offers a password protection. The group addresses can be handled with "drag & drop". Internally up to 2000 group addresses can be handled.

The colour touch panel comes without the design frame and the flush mounted recessed box !

4 Technical data

Supply of KNX	
Voltage:	21 ... 32 V DC
Power consumption:	typ. 150 mW
Connection:	Bus terminal
External supply	
Voltage:	230 V AC \pm 10 %
Current:	max. 250 mA
Connection:	Screw terminals: 0.5 mm ² to 4 mm ² , single wire 0.34 mm ² to 4 mm ² , stranded wire (without ferrule) 0.14 mm ² to 2.5 mm ² , stranded wire (with ferrule)
Response to mains failures	
Bus voltage only:	no communication with KNX
Mains voltage only:	no communication with KNX
Bus and mains voltage:	no communication with KNX
Response on return of voltage	
Bus voltage only:	no communication with KNX
Mains voltage only:	no communication with KNX
Bus and mains voltage:	communication with KNX according to parameter
Protection:	IP 20
Mark of approval:	KNX
Ambient temperature:	-5°C ... +45°C
Storage temperature:	-25°C ... +70°C (storage above +45°C reduces the service life)
Max. operational temperature:	T _c = 75°C
Fastening:	in flush mounted wall box
Dimensions W x H x D:	231 x 159 x 48 mm

Assembling of the Colour touch panel:



Note:

Due to the same dimensions the panel fits into the same box than the LCD mini panel, ref.-no. MT 701 !

5

Functional description:

- 5.7" TFT touch screen with a resolution of 4096 colours and 320 x 240 pixels.
- Panel can be installed in panel or landscape format.
- BMP- or JPG-format can be used for wall paper. Eight colour schemes can be defined.
- Up to 50 freely programmable pages with up to 400 display elements can be created.
On each page up to 16 display elements can be defined.
- Each display element can be assigned to up to four different functions.
- The display elements can be used for all available KNX functions including displaying ASCII text.
- Four password levels are available for access control.
- Programming with a comfortable ETS Plug-in. The commissioning can be done directly via the integrated USB or via bus.
The first download should be done with the direct USB which is much faster than via bus.
- Weekly timer with up to 16 channels.
- Internal clock which can be used as system time.
- Up to 24 light scenes with up to 32 different lighting groups can be assigned.
The light scenes can be defined in independent light scene control zones.
- Up to 80 logic links with up to 8 inputs and up to 12 multiplexers with up to 3 channels are available.
In addition, the panel offers up to 40 filter time elements which can be widely used.
- Up to 50 failure/alarm messages can be organised whereby up to 20 can be displayed simultaneously.
The alarms are recorded in a protected message list.

Displaying – Reporting

Colour Touch Panel (frames)

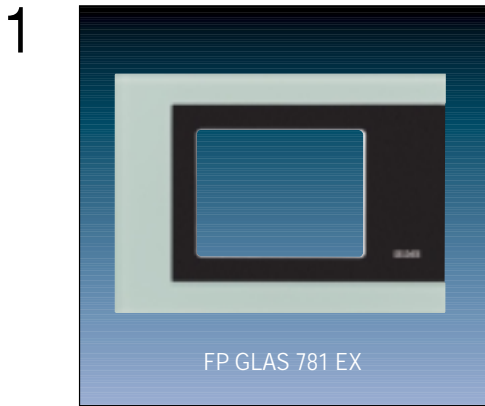

Dimensions (W x H x D) 236 x 170 x 10 mm

2

	Ref.-No.
Design frames	
for KNX Colour touch panel FP 701 CT	
stainless steel	FP ES 781
aluminium	FP AL 781
glass (safety glass – ref. DIN 1249 –, satined surface	FP GLAS 781 EX
without JUNG-logo on request	

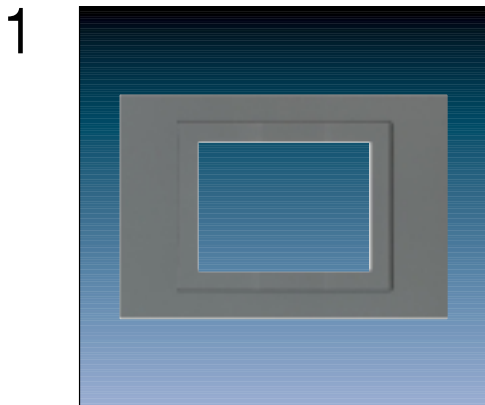

Dimensions (W x H x D) 236 x 170 x 6 mm

2

	Ref.-No.
Frame	
for KNX Colour touch panel FP 701 CT	
anthracite	FP 781 AN

Displaying – Reporting

Accessories

1



2

Flush mounted recessed box
212 x 124 x 75 mm (W x H x D)
Fits for MT 701 and FP 701 CT.

Ref.-No.

EBG 24

1

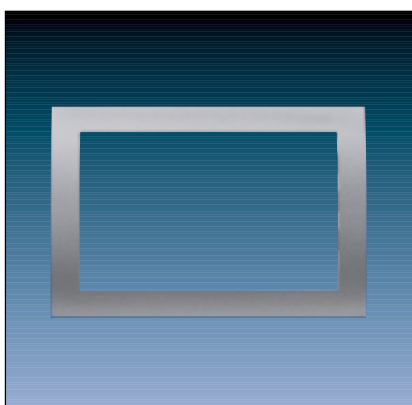

2

Frame for mini panel MT 701

white

black

stainless steel (painted)

aluminium (painted)

Ref.-No.

R 24 WW

R 24 SW

R 24 ES

R 24 AL

1



2

	Ref.-No.
KNX Telecontrol interface TC Plus	
wall mounted	2601
ETS-product family:	Communication
Product type:	Modem

3

The TC Plus is being offered in different types (analog, ISDN, GSM) with and without KNX module. These operating constructions apply to all types.

The TC Plus is an alarming and remote switching device by which up to 6 conventional devices can be switched via telephone. All settings will be saved in case of a power failure – except for time and date. The behaviour of the outputs in case of a power failure can be set (after return of the power voltage: ON, OFF or restoring the switching state before the power failure).

Conventional relays or current-impulse switches can be connected to the switching outputs.

Furthermore, the TC Plus is sending messages to selected participants (cf. phone numbers). These messages are activated by up to 6 contacts (series) which are connected to the alarm inputs (N1 to N6). At each of the inputs break or make contacts can be installed.

Additionally, when connected to KNX, up to twenty communications objects can be controlled and up to 6 alarms can be processed.

Should given messages – send off by the alarm inputs M1 to M6 or by KNX – not be confirmed, a local alarm output will be switched.

The controlling will either be performed with a DTMF telephone (DTMF = Dual-tone multi-frequency) or with a DTMF pocket dialer (optional).

In case of an answering machine being used at an analog connection (AB mode), either the answering machine or the TC Plus can be addressed.

Individual user data are easy to program.

The TC Plus is operated by turnkey. Operation is supported by plain texts on a 20 character 4 line alphanumeric LCD field and also by announcements. The user can choose among 6 display languages for the messages.

The respective software is enclosed in the scope of delivery and supports comfortable configuration. The PC must have a serial interface.

Messages are transferred exactly to the selected participants by announcements, SMS, e-mail, or fax. The number of dial attempts (0 to 12) can be set.

The announcements can be individually recorded by the user. In order to do this, the handset (optional) with the 4-way RJ connector has to be inserted in the socket.

The device comes with a CD-ROM which includes the configuration software, an animation, the operation manual as well as the data base.

4 Technical data

Supply of KNX	
Voltage:	21 ... 32 V DC (SELV)
Power consumption:	max. 150 mW
Connection:	screw terminals
External supply (plug power supply)	
Voltage input:	100 – 240 V AC; 50 / 60 Hz
Voltage output:	12 V DC, 1.25 A
Length of power supply cord:	2 m
Response to voltage failure	
Bus voltage and/or mains voltage:	device is not working, KNX settings are saved, date and time are deleted
Response on reactivation	
Bus voltage and/or mains voltage:	parameter-dependent, conditions of outputs (conventional and KNX) can be parameterized
Bus and mains voltage:	no communication with KNX
Input	
Number:	6 conventional potential free contacts (terminal M1 – M6)
Connection:	screw terminals
Output	
Number of outputs:	6 (terminal A1 – A6), conventional 1 local alarm output (terminal A0)
Switching voltage:	12 V DC, 100 mA
Max. switching current:	total max. rating of all outputs max. 700 mA, short circuit proof and surged with 200 mA
Connection:	screw terminals
Protection:	IP 30
Dimensions:	L x W x H (251 x 204 x 49 mm)
Weight:	700 g
Colour:	RAL 7035, light grey (material ABS)
Operation temperature:	-5°C ... +45°C
Max. operational temperature:	-5 °C to 45°

5 Description of software application

- Works as an additional device like an answering machine.
- The TC Plus is mainly developed for an analog telephone network. Optional it can be used also via an analog port of an ISDN unit.
- A special version for GSM is also available on request.
- All announcements / instructions are individually recorded.
- Access protection by a code number with 4 digits.
- A total status recall is possible.
- Control of up to 10 KNX functions whereby three different data formats can be selected: 1 bit, 1 byte and 2 byte.
- For the alarm inputs and the KNX inputs the contacts can be defined.
- Up to 4 destinations to each input can be defined.
- The TC Plus can be programmed by turnkey and the display, however the more comfortable method is by using the PC software tool (various languages available).
- Display messages can be adjusted to German, English, French, Spanish, Italian or Dutch.
- Provider selection for the transmission of SMS or e-mail (subject of corresponding country).
- Up to 20 alarm messages can be stored in an alarm buffer.

Communication

KNX/Radio Converter

1



2

	Ref.-No.
KNX Radio-controlled converter	2700 AP
ETS-product family:	Communication
Product type:	Radio

3

The radio-controlled Converter serves to integrate the JUNG Radio Management transmitters into the KNX system. Radio telegrams from learned transmitters are converted into corresponding KNX telegrams. The data transfer is unidirectional.

The following Radio Management transmitters can be used:

- Hand-held transmitters: Comfort (48 KFH), Standard (48 FH) and Mini (42 FH)
- Wall-mounted transmitters: 40 FW, ..41 F., ..42 F., ..44 F.
- Universal Transmitter: FUS 22 UP
- Radio controlled observer: FW 100 WW

Up to 50 channels with different channel functions can be parameterised. A total of 100 memory locations for keys (e.g. hand-held transmitter keys) and devices (e.g. radio controlled observer) are available.

4

Technical data

Supply		Input	
Voltage:	24 V DC (+6 V / –4 V)	Number:	50
Power consumption:	typical 170 mW	Transmission:	radio frequency
Connection:	KNX connection block	Frequency:	433,42 MHz
External supply	Only required in the learn resp. clear mode	Modulation:	ASK (Amplitude Shift Keying)
Voltage:	9 V DC battery block (type 6LR61)	Protection:	IP 20
Power consumption:	typ. 140 mW	Behavior at bus voltage drop:	no reaction
		Behavior at bus voltage recovery:	no reaction
		Operation temperature:	–5°C ... +45°C
		Storage temperature:	–25°C ... +70°C

Note: To improve the radio reception, the antenna must be brought outward through the cable support sleeve.

5

Channel functions:

- Switching – The function of the left (upper) and the right (lower) push button can be parameterised.
- Toggling – Alternating transmission of On and Off telegrams for each push button
- Dimming – Dimming steps adjustable / – Telegram repetition and stop telegram possible
- Shutter/Blinds – Push button function (Up, Down) and the time between short and long time operation adjustable.
 - Louvres adjustment time can be set.
- Value transmitter – Value (0...255) of the left (upper) and the right (lower) push button can be parameterised.
- Light mood extension – Number of light mood (1...8) of the left (upper) and the right (lower) push button can be parameterised.
 - Light mood storing function possible
- Light mood – Recalling and storing up to 5 light moods with eight outputs each.
 - The object type for switching (1 Bit) or dimming value (1 Byte) can be adjusted per output.
- Automatic switch – 1Bit switching or 1Byte value telegrams depending on the adjusted brightness value.
 - Telegram at the beginning and at the end of a detection adjustable.
 - Delay time at the end of detection and immunity time adjustable.
- Universal Transmitter as switch – On and Off telegrams according to the received Universal Transmitter telegrams.

5 Operation modes

The radio controlled KNX converter offers three different modes of operation:

1. Service mode: transfer of received radio telegrams to KNX telegrams (normal operation)
2. Learning mode: for teaching in keys and devices
3. Deleting mode: for deleting keys and devices

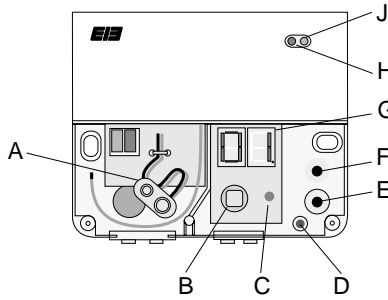

- A: Battery-Clip
- B: Acknowledge push-button
- C: Programming-LED (red)
- D: Programming push-button
- E: Channel selection (downwards)
- F: Channel selection (upwards)
- G: Channel and status display
- H: Receiving-LED (red): LED flashes when unknown telegrams are received
- J: Operation-LED (green): LED is on and flashes when known telegrams are received

Switching between the different modes

Changing between the different modes as shown in the diagram. For this purpose, the battery must be connected to clip (A).

Switching between operation mode ↔ Learning mode

- Connect the battery to clip (A) for activating the display (G).
- Press channel selection keys (E and F) simultaneous for approx. 5 seconds. The display will go to '01.', right decimal point being lit.

Learning a new key or a new device:

- Set desired ETS channel number with the channel selection keys (E and F).
- Actuate radio controlled transmitter until display reads 'LE' (learned).
(Actuation time: between 1s (for channel keys) and 10s (for All-On or All-Off key))
- To save the key or the device on the ETS channel press acknowledge push-button (B).
Learning will be indicated by the channel number shortly blinking in display (G).
- The learning process can be cancelled by channel selection keys (E or F).
To have further devices or keys learned-in, start from the beginning again.

Note: If all 100 memory locations are occupied within the device, the display will read 'OF' (Overflow).

Deleting mode

The deleting mode allows the following operations:

- Delete a key or device of an ETS channel
- Delete all keys or devices of an ETS channel
- Delete the entire memory

Deleting a key or device of an ETS channel

1. Actuate the key or device to be deleted until the associated ETS channel number blinks in the display. Actuation time: between 1 s (for channel keys) and 10 s (for All-On or All-Off key).
2. By pressing the acknowledge key for approx. 3 s, the key or device can be deleted from the memory. During the deleting process, the display will read '- -'. After the completion of the deleting process, the channel number will be displayed.
3. The deleting process can be cancelled by pressing any channel selection key.

Deleting all keys and devices of an ETS channel

1. Select the ETS channel to be deleted with the channel selection keys.
2. By pressing the acknowledge key for approx. 3 s, the deleting process will be initiated. The display will read 'CE' (Clear Entry).
After the completion of the deleting process, the ETS channel will reappear in the display.

Deleting the entire memory

1. By pressing the acknowledge key for approx. 3 s, the deleting process will be initiated.
The display will read 'AC' (All Clear).
After the completion of the deleting process the display will read '00'.

To return to the service mode after the deleting process, remove the battery.

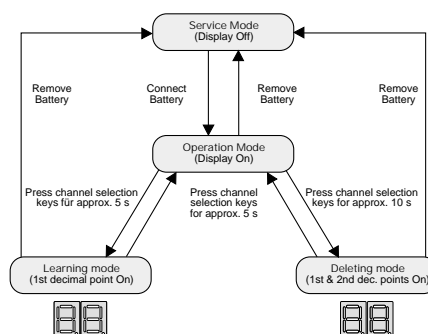



2

	Ref.-No.
KNX IR-Gateway	A 2800 IR ..
ETS-product family:	Communication
Product type:	Infrared

3

The KNX IR-Gateway is a device for the transmission and reception of IR signals. As a receiver, the gateway converts the IR signal codes received from standard remote controls into KNX telegrams. As a transmitter, the KNX commands are converted into IR codes so that TV, HIFI, video or other IR-receiver-equipped devices within reach can be controlled. Both applications can also be combined.

In this way, existing consumer electronics equipment or IR-controllable lighting systems can be integrated into intelligent building automation systems and remote-controlled from other rooms, too.

The IR components can moreover be integrated into different scenes or presence simulations. A large number of commercial IR remote controls can be programmed to work with the IR-Gateway. For perfect operation, the remote controls must, however, comply with the RC-5 standard. In this standard, each signal key of the remote control activates a distinct IR signal code which can be understood by the IR-Gateway. Programming of individual IR signals and the allocation to existing bus channels is effected simply triggering the sensor or actuator function on the bus side and by local actuation of the device itself. In this way, the user can always adapt the IR remote controls with minimum effort to the IR-Gateway.

The KNX channels and thus the link with the electrical installation are predefined in the ETS before commissioning. The max. 32 bidirectional bus datapoints can be parameterised for the following functions: "Switching (1 bit)", Dimming (4 bits)", or "Value (1 byte)".

In the switching and dimming functions, up to 2 IR signals respectively can be programmed (e.g. key A: "On" / key B: "Off" or key C: "Increase brightness" / key D: "Reduce brightness").

With the value transmission function, a distinct 1-byte value can be assigned to an IR signal. In the IR transmitter function, the programmed IR signals can be transmitted cyclically several times.

4

Technical data	
KNX supply	
Voltage:	21 – 32 V DC (via BCU)
Power consumption:	typ. 300 mW
Connection:	bus connecting and branching terminal
Response to voltage failure:	No reaction, IR communication no longer possible.
Response to return of voltage:	No reaction. The operating mode corresponding to the position of the slide switch or of the reset potentiometer is executed.
Infrared	
Number of IR codes:	Max. 32 codes programmable for "Value" function Max. 64 codes programmable for "Switching" or "Dimming" functions
Coding:	In accordance with RC-5 standard (bit-phase coding)
Modulation:	ASK with 20 ... 70 kHz carrier frequency
Wavelength of IR light:	920 ... 970 nm
Range:	approx. 10 m for a horizontal aperture of 30° from sensor centerline

4 Technical data

Protection:	IP 20
Mark of approval:	KNX
Ambient temperature:	-5°C ... +45°C
Storage temperature:	-25°C ... +70°C (storage above +45°C results in shorter lifetime)
Mounting position:	Slide switch at the bottom
Minimum spacings:	none
Fastening:	Plug on flush-mounted BCU (BCU 2), included

5 Description of software application:

Objects

Number of addresses:	32
Number of assignments:	32
Communication objects:	32

Object	Name	Function	Type	Flag
Function: Switching (1 bit)*				
0 – 31	Channel 1 to 32	Switching	1 Bit	C, W, T (R)**, A
Function: Dimming (4 bit)*				
0 – 31	Channel 1 to 32	Dimming	4 Bit	C, W, T (R)**, A
Function: Value (1 byte)*				
0 – 31	Channel 1 to 32	Value transmitter	1 Byte	C, W, T (R)**, A

* : Each channel can have its own function assigned independently. Therefore, also the visible objects change dynamically.

** : Objects marked (R) permit read-out of the object status (set R flag).

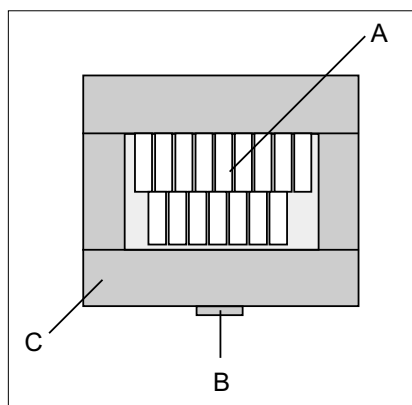

A : IR window with LED status display:

Red static: Charging of energy storage capacitor in progress.
The device is not ready for operation. Please wait!

Red flashing: Device is deactivated. Slide switch in position "OFF" or error during programming (learning mode).

Green static: Learning mode is active.

Green flashing: Learning mode automatically aborted (no input for more than 2 min during active time). Device without function.

Orange (flashing once briefly):
In normal mode: IR signal transmission (can be enabled via parameter).
In learning mode: IR signal is now programmed.

Orange static: Erase mode active. Device is without function.

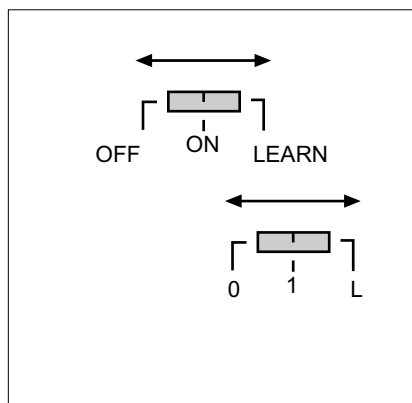

B : Slide switch:

- Pos. "ON": Normal operation
- Pos. "OFF": Off
- Pos. "LEARN": Learn mode

IR/bus conversion possible.
No IR communication. IR window flashes red.
IR signals can be programmed.
No IR/bus conversion possible.

C : Reset potentiometer (at the rear)

5

Note:

- The IR-Gateway must only be used on BCU 2 bus coupler, supplied with the device. Installing the IR-Gateway on other flush-mounted bus couplers (BCU 1) results in a malfunction.
- As the IR-Gateway needs more energy during the transmission of IR signals and as the bus coupler can supply only a limited current, the device is equipped with an energy storage capacitor (Gold-Cap). This storage capacitor must be recharged after initial commissioning and after a prolonged bus voltage failure (> 5 h). During the recharging phase, the device is not ready for operation and the IR window shines permanently red. After a recharging time of approx. 10 minutes, the energy storage capacitor is recharged. After recharging, a prolonged and trouble-free operation is ensured.
- If the IR-Gateway is withdrawn from the bus coupler for a prolonged time (> 5 h), the slide switch should be moved to position "OFF". In this case, unnecessary discharging of the energy storage capacitor can be avoided.
- Transmission range reductions must be expected, if the batteries of the used and programmed IR transmitters (e.g. TV remote control) are weak or discharged.
- IR transmissions use frequencies on a non-exclusive basis. This means that IR transmissions from other transmitters that are not programmed into the gateway can cause malfunctions or make the recognition of programmed IR signals impossible.

Choosing the place of installation

The place of installation should be chosen in such a way that the optimal communication range can be achieved in operation.

For proper functioning, the IR-Gateway needs visual contact with the IR devices (e.g. audio equipment) to be controlled and with the IR remote controls from which commands are transmitted to the gateway.

For this reason, the place of installation is to be chosen such that

- the IR-Gateway can be easily aimed at with an infrared remote control in operation,
- the visual contact between the gateway and the devices to be controlled is not restricted by objects, pieces of furniture, curtains, etc.

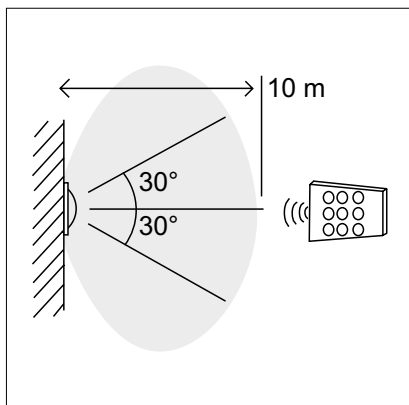

The range (approx. 10 m) is optimal within an angle 30° (from the median line). Even greater distances and angles can be achieved when transmitter and receiver are arranged in a straight line. The same applies, if the IR light can be reflected from walls or pieces of furniture in the room.

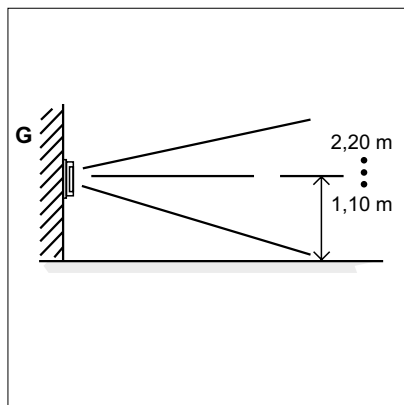

The gateway can be installed at hand level (1.10 m), but also at a height of 2.20 m. The range is reduced

- outside the specified boundaries,
- when the IR remote control batteries are weak or discharged.

Communication

Bluetooth Gateway

1

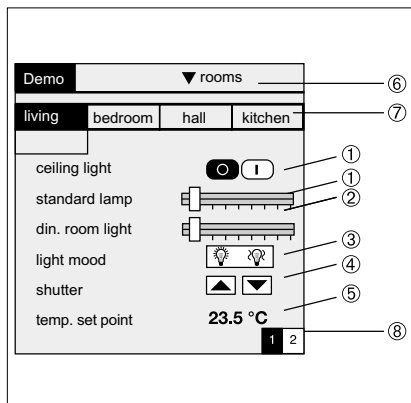

Operating elements

- ① Switching: 1 = switch, 0 = switch off
- ② Dimming: 0 ... 100%
- ③ Light scene : Activated by pressing button
- ④ Blinds: UP/DOWN: long or short operation
- ⑤ Temperatures: Display of setpoint or actual values
- ⑥ Toggling between display of rooms, functions or messages
- ⑦ Selection of the required room
- ⑧ Further page(s) with further control options

2

	Ref.-No.
KNX Bluetooth Gateway	
ETS-product family:	Communication
Product type:	Radio
ranges CD 500/CD plus	
ivory	BG 2041
white	CDBG 2041 WW
blue	CDBG 2041 BL
brown	CDBG 2041 BR
grey	CDBG 2041 GR
light grey	CDBG 2041 LG
red	CDBG 2041 RT
black	CDBG 2041 SW
ranges LS 990/LS plus/Stainless Steel/Aluminium/Anthracite/Gold/Chrome	
ivory	LSBG 2041
white	LSBG 2041 WW
light grey	LSBG 2041 LG
Metal versions	
stainless steel	ESBG 2041
aluminium	ALBG 2041
anthracite	ALBG 2041 AN
gold coloured	GOBG 2041
chrome	GCRBG 2041
ranges AS 500/A 500/A plus	
ivory	ABG 2041
white	ABG 2041 WW
aluminium	ABG 2041 AL

2

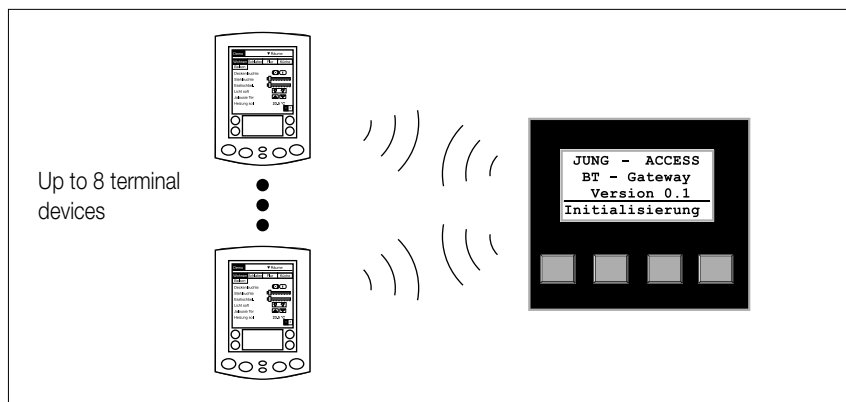

Bluetooth® wireless communication links a wide variety of devices without any cables over short distances and transfers speech, data and images so that cable connections can be completely replaced over these distances.

3

The Bluetooth Gateway allows the wireless control and visualization of KNX projects.

It is possible to switch or dim lightings, call-up and store light scenes, control shutter or blinds or to display and shift 2 Byte values (e.g. room temperatures).

The KNX project can be controlled via a hand held computer (PDA, Personal Digital Assistant) taught into the Bluetooth Gateway with a special software.

The following end devices will be supported:

- PDA of the product family "Palm Tungsten T" with operation systems OS v 5.0; Palm Treo
- Pocket-PC with operation system Microsoft Windows, Version "Windows Mobile 2003" (WinCE) with Bluetooth linking-software of company "Widcom" or "Broadcom" (Fujitsu-Siemens Pocket L00X, A SUS Mypal, HP iPAQ hx 4700/hx 4705, HPI PAQ hx 2750 with Windows Mobile 2003 SE, HP iPAQ vx 3115).

For the time being, the software of the Bluetooth Gateway is under development to match the latest operation systems of modern Windows based PDA's!

Up to 8 end devices can be taught into the Bluetooth-Gateway. Vice versa the application software of an end device can act on up to 7 gateways. In general only one connection to an end device or to a gateway can be active.

The operation push-buttons and the display ease the teach-in process and allow further adjustments at the Bluetooth-Gateway.

The user interface of the application software depends on the programming of the gateway by the ETS plug-in.

In the ETS up to 8 rooms and up to 8 functions can be assigned.

After an end device has been taught into the gateway and connected for the first time, the KNX configuration will be downloaded to the end device automatically.

With any further connection, the end device recognises any update of the device configuration within the gateway and activates a balancing automatically.

During an active connection, the data received from the KNX will be transferred to the end device. Vice versa actions from the end device will be sent to the bus. The possibility of changing values at the end device can be locked within the ETS plug-in.

While starting a connection by the end device, the actual bus data will be aligned in the gateway, this way the end user always has the correct and topic conditions. In addition, depending on the parameterisation, the Bluetooth Gateway can read out the topic status of the data points after bus voltage recovery.

The operation at the gateway can be locked by a 6 digit PIN number.

For the communication between gateway and end device the "frequency hopping" transmission is used in order to avoid any disturbances by other radio systems.

The Bluetooth transmission between gateway and end device is coded (up to 128 bit). The coverage is up to 10 meter (free field) and is basically defined by the used hand held computer.

4

Technical data

KNX supply

Voltage: 21 – 32 V DC (via BCU)

Power consumption: typ. 300 mW

Connection: bus connecting and branching terminal

Response to voltage failure

Bus voltage only: No Bluetooth communication possible.
The end device announces failure and shuts down communication.

Response to return of voltage

Bus voltage only: A Bluetooth connection can be established. A connection shut down by voltage failure will not be reestablished automatically. During establishing of a connection by the end device, the read out status will be adjusted.

Bluetooth

Specification: Bluetooth Version 1.1 (IEEE 802.15.1-2002)

Transmission Mode: ISM-Band 2.4 ... 2.4835 GHz (licence free)

Frequency: Modulation: Gaussian Frequency Shift Keying (GFSK)

Frequency-Hopping acc. to Bluetooth-Standard with 79 channels
Spread Spectrum (FHSS)

4 Technical data

Frequency:	Modulation: Gaussian Frequency Shift Keying (GFSK) Frequency-Hopping acc. to BluetoothStandard with 79 channels Spread Spectrum (FHSS)
Transmitting power:	Controlled transmitting power max. 2.5 mW (class 2) (→ coverage max. 30 mm freefield) max. 10 m freefield using end devices of Class 3– (1 mW / e.g. PDA)
Security mode:	2
Protection:	IP 20
Mark of approval:	KNX
Ambient temperature:	–5°C ... +45°C
Storage temperature:	–25°C ... +70°C (storage above +45°C results in shorter lifetime)
Mounting position:	any
Minimum spacings:	none
Fastening:	Plug on BCU

Note:

- The Bluetooth Gateway must be used only with its accompanying BCU.
This is a special BCU for devices with higher power consumption (2 bus loads).

5 Description of software application:

Objects

Number of addresses:	77
Number of assignments:	200
Communication objects:	77

Object	Name	Function	Type	Flag
Function: Switching 0 – 69	Object 0 – 69	–	1 Bit	C, W, T (R)*, status**
Function: Dimming value transmitter 0 – 69	Object 0 – 69	–	1 Byte	C, W, T (R)*, status**
Function: Shutter/blinds 0 – 69	Object 0 – 69	–	1 Bit	C, W, (R)*
Function: Light scene extension 0 – 69	Object 0 – 69	–	1 Byte	C, W, (R)*
Function: Value indication 0 – 69	Object 0 – 69	–	2 Byte	C, W, T (R)*, status**
Function: Alarm message 0 – 69	Object 0 – 69	–	1 Bit	C, W, T (R)*
Function: Alarm message acknowledgement 0 – 69	Object 0 – 69	–	1 Bit	C, W, T (R)*
Function: Alarm message after removal of application module 0 – 69	Object 0 – 69	–	1 Bit	C, W, T (R)*

* : Objects marked (R) permit read-out of the object status (set R flag).

** : If the status inquiry is released, the object value will be read after bus voltage recovery (Value read). An answer (Value response) will be processed, stored and leaded to the end-device in case of an active connection, If no answer will be received (Na value response) the object value stays "OFF" resp. "0".

Communication

DALI-Gateway

1

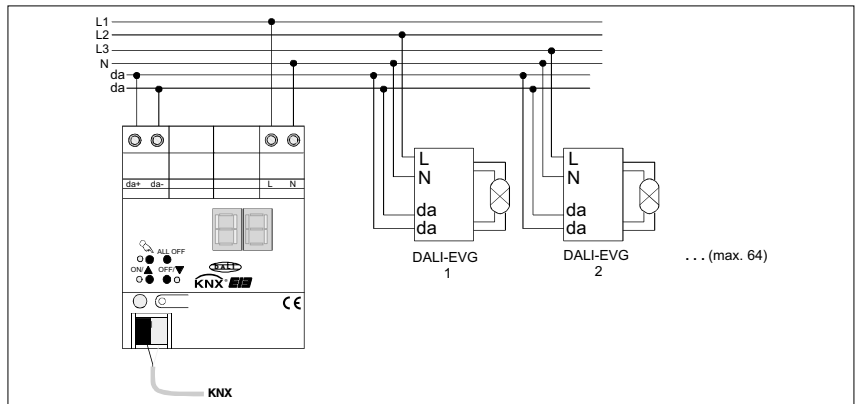
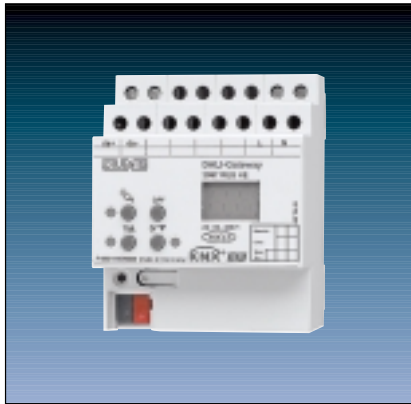

2

	Ref.-No.
KNX DALI-Gateway	2097 REGHE
ETS-product family:	Illumination
Product type:	Dimmer
Series embodiment (SE)-device (4 units)	

3

The DALI-Gateway serves as an interface between a KNX installation and a digital DALI (Digital Addressable Lighting Interface) lighting system. The DALI-Gateway allows switching and dimming of max. 64 lamps with a DALI ballast. Each lamp can be assigned into up to 32 different lighting-groups. This way, the integration of a room orientated lighting control for e.g. open-plan offices, multi-purpose rooms, factory floors and training class rooms into the KNX is possible. The lighting groups can be integrated in up to 16 light scenarios in order to call up or save different light scenes. A separate acknowledge of all single switching status and the brightness values is possible. General DALI operation conditions such as failure, short circuit and supply voltage can be reported to the bus. For a quick functional check, all lighting groups can be operated manually (switching and dimming) by means of the 4 push-buttons on the device, even without bus-voltage or programming. The DALI-Gateway will be configured by an ETS 3 embedded plug-in. It is recommended to use the ETS 3.0d version.

4

Technical data

KNX supply	
Voltage:	21 – 32 V DC (SELV)
Power consumption:	typ. 150 mW
Connection:	Bus terminal (KNX Type 5.1)
External supply	
Voltage:	110 ... 240 V AC +10 %/–15 %, 50/60 Hz
Power consumption:	approx. 6 W
Connection:	Screw terminals: 0.5 – 4 mm ² solid or finely stranded conductor without wire end sleeve 0.5 – 2.5 mm ² finely stranded conductor with wire end sleeve Stud torque max. 0.8 Nm
Total power loss:	max. 3 W
Behavior at bus voltage drop:	Depending on parameter
Behavior at bus voltage recovery:	Depending on parameter
DALI	
Voltage:	typ. 16 V DC, with over-voltage protection
Current:	typ. 128 mA, max. 200 mA short term rated for max. 64 DALI-devices á 2 mA with short-circuit and overload protection
Transfer rate:	1200 bit/s
Protocol:	Acc. to DIN EN 60929, E4

4 Technical data

Cable length between gateway and all ballasts

Ø 1.5 mm ² :	max. 300 m
Ø 1.0 mm ² :	max. 238 m
Ø 0.75 mm ² :	max. 174 m
Ø 0.5 mm ² :	max. 116 m
Characteristic impedance:	max. 4 Ω (single length) / max. 8 Ω (return line)

Protection:	IP 20
Safety class:	III
Mark of approval:	KNX
Ambient temperature:	-5°C ... +45°C
Storage temperature:	-25°C ... +70°C (storage above +45°C results in shorter lifetime)
Mounting position:	any, recommended: output terminals on top
Minimum spacings:	none
Fastening:	on DIN rail 35 x 7.5

5 Description of software application:

- Control of max. 64 DALI devices in max. 32 groups.
- Independent hand-operation of the outputs.
- Acknowledge of DALI failure status, short-circuit and failure of supply voltage.
- Central switching function.
- Acknowledge switching: active (at changing or cyclically) or passive (object can be read out).
- Adjustment of brightness limits.
- Dimming behaviour can be adjusted.
- Soft-On or soft-Off-function.
- Inhibit or alternatively forced position function per group. During inhibit function the blinking of the connected lighting groups is possible.
- Time-functions (Switch On/Off delay, stair-case function – also with advance warning).
- Integration of the lighting groups in up to 16 light scenarios.
- DALI commissioning with ETS plug-in.

Objects

Number of addresses:	254
Number of assignments:	255
Communication objects:	216

Superior channel objects:

Object	Name	Function	Type	DP-Type	Flag
Function: Scenario					
☐ 208	Light scene extension	Scenario	1 Byte	18.001	C, W, -, (R) ¹
Description:	1 Byte object for calling-up or storing scenarios.				
Function: DALI-functional monitoring					
☐ 210	Acknowledge	DALI-failure status	1 Byte	---	K, S, Ü, (R) ^{1, 2}
Description:	1 Byte Object for the transmission of the failure status of DALI devices to the bus. The bits are used as follows: Bit 0 ... 5: Number of the DALI device (0 ... 63) Bit 6: Lamp failure (0 = no failure, 1 = failure) Bit 7: Ballast failure (0 = no failure, 1 = failure) This object can, independent of the parameter setting for the ACK, always also receive telegrams (Value Write). A received telegram will be answered by that object directly (Value Write). The topic internal status will be sent out. In the inquiry telegram, the Bits 0 ... 5 must include the number of the DALI device. Bits 6 and 7 must be set to "1". Otherwise the inquiry telegram will be ignored.				
Function: DALI-functional monitoring					
☐ 211	Report	DALI voltage failure	1 Bit	1.005	C, -, T, (R) ¹
Description:	1 Bit object for reporting a net-voltage failure at the DALI-Gateway. (Voltage ok = 0, voltage failure = 1)				

¹: Objects marked (R) permit read-out of the object status (set R flag).

²: Depending on the parameter, acknowledge objects are either active (T-Flag set) or passive and can be read out (set R-Flag).

5	Object	Name	Function	Type	DP-Type	Flag
	Function: DALI-functional monitoring					
	212	Report	DALI short circuit	1 Bit	1.005	C, -, T, (R) ¹
	Description: 1 Bit object for reporting a short-circuit on the DALI wiring. (no short-circuit = 0, short-circuit = 1)					
	Function: Central function					
	213	Switching	Central function	1 Bit	1.001	C, W, -, (R)
	Description: 1 Bit Object for central switching of all assigned DALI groups. Polarity adjustable.					
	Function: Hand-operation					
	214	Inhibit	Hand-operation	1 Bit	1.003	C, W, -, R ¹
	Description: 1 Bit Object for inhibiting the push buttons. Polarity adjustable.					
	Function: Hand-operation					
	215	Status	Hand-operation	1 Bit	1.002	C, -, T, R ¹
	Description: 1 Bit Object for the status of hand-operation. Object "0": hand-operation deactivated (bus-operation). Object "1": hand-operation activated.					
	Channel objects:					
	Function: Output-switching					
	0, 7, 14, ... , 105, 112, 118, ... , 202	Group 1 ... 32	Switching	1 Bit	1.001	C, W, -, (R) ¹
	Description: 1 Bit object for switching a DALI group On/Off ("1" = On / "0" = Off).					
	Function: Relative dimming					
	1, 8, 15, ... , 106 113, 119, ... , 203	Group 1 ... 32	Dimming	4 Bit	3.007	C, W, -, (R)
	Description: 4 Bit object for dimming of a DALI group.					
	Function: Absolute dimming					
	2, 9, 16, ... , 107 114, 120, ... , 204	Group 1 ... 32	Brightness value	1 Byte	5.001	C, W, -, (R)
	Description: 1 Byte object for an absolute value (brightness value 0 ... 255).					
	Function: Acknowledge absolute dimming					
	3, 10, 17, ... , 108 115, 121, ... , 205	Group 1 ... 32	ACK brightness value	1 Byte	5.001	C, -, T, (R) ²
	Description: 1 Byte object for ACK of an adjusted dimming value.(0 ... 255)					
	Function: Acknowledge switching					
	4, 11, 18, ... , 109 116, 122, ... , 206	Group 1 ... 32	Acknowledge switching	1 Bit	1.001	C, -, T, (R)
	Description: 1 Bit object for ACK of the switching status ("1" = On / "0" = Off).					
	Function: Stair-case function ³					
	5, 12, 19, ... , 110	Group 1 ... 16	Stair-case function start / stop	1 Bit	1.010	C, W, -, (R)
	Description: 1 Bit object for activation or deactivation of the switch-on time of the stair-case function ("1" = On / "0" = Off).					

¹: Objects marked (R) permit read-out of the object status (set R flag).

²: Depending on the parameter, acknowledge objects are either active (T-Flag set) or passive and can be read out (set R-Flag).

³: The stair-case function is available for the first 16 groups only.

5

Object	Name	Function	Type	DP-Type	Flag
Function: Inhibit					
□ 6, 13, 20, ..., 111					
117, 123, ..., 207	Group 1 ... 32	Inhibit	1 Bit	1.003	C, W, -, (R) ¹
Description: 1 Bit object for inhibiting of a group (Polarity adjustable).					
Function: Forced position					
□ 6, 13, 20, ..., 111					
117, 123, ..., 207	Group 1 ... 32	Forced position	2 Bit	2.001	C, W, -, (R)
Description: 2 Bit object for the forced position of an output. Polarity given by the telegram.					

¹: Objects marked (R) permit read-out of the object status (set R flag).

Communication

IP Central unit

1

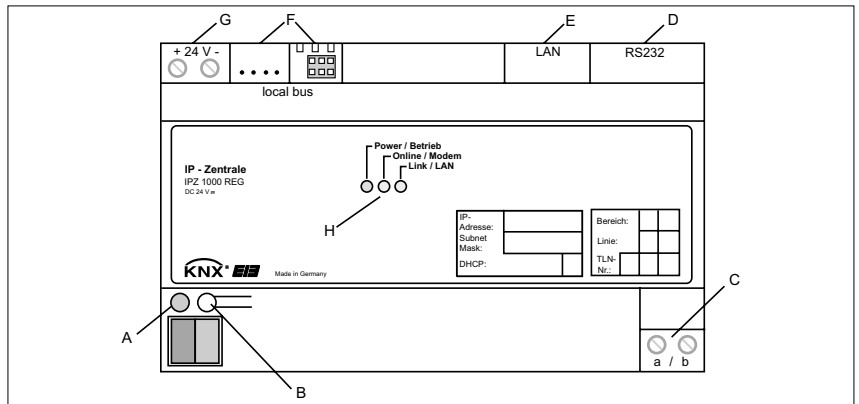

- | | |
|---|---|
| <p>A programming LED (red)</p> <p>B programming button</p> <p>C a/b trigger input (e.g. extension output of a telecommunication system for analog terminals)</p> <p>D RS 232 (V.24) interface for connection of an external modem</p> <p>E LAN connection RJ45 socket</p> <p>F connection for local bus (reserved for future applications)</p> <p>G terminals for connection of external power supply</p> | <p>Power (green): Permanently lit up after initialization when the supply voltage is present.</p> <p>Online / Modem (yellow): Signals an active Internet connection via the modem (RS232)</p> <p>Link / LAN (yellow): Lit up in case of an existing link with the LAN (link with an Ethernet connection point as, for instance, a hub or a switch (straight) or a PC (cross). Flickers during the transmission of data via the LAN.</p> |
|---|---|

2

Ref.-No.	KNX IP Central unit
	IPZ 1000 REG
	ETS-product family: Communication
	Product type: IP
	Series embodiment (SE)-device (8 units)

3

The IP central unit is the interface between an Ethernet (LAN = Local Area Network) and the KNX. With the help of an Ethernet connection, the user has access to his intelligent building management system via a local PC of his LAN or via the Internet. The connection with the Internet cannot only be established via an LAN (e.g. in conjunction with DSL) but also with an analog modem (e.g. V.90 56K) or with an ISDN modem (with RS232 interface). The IP central unit can thus be easily integrated into new or already existing home or office networks.

The IP central unit acts as a web server and can be comfortably operated from a browser (Microsoft® Internet Explorer Version 5.5 and higher) as a control, reporting and monitoring unit.

The IP central unit moreover permits user-guided commissioning and configuration by enabling the user to make different settings via the web user interface. The KNX configuration is ensured by an ETS-embedded plug-in.

The central unit can work as a bus system clock by using the standard time supplied by a time server in the Internet. The system clock can work as a central year time switch with astro function and day profiles (scheduler) and as a presence simulator. In addition, the following features are available: logic gates and information function per e-mail, an integrated e-mail address book, central functions and scenes for lighting, HVAC and alarm systems.

4	Technical data	
	KNX supply (bus terminal)	
	Voltage:	21 – 32 V DC SELV
	Power consumption:	typically 150 mW (the bus controller is supplied from the external power supply)
	Connection:	KNX supply and branch terminal
	External supply (screw terminal)	
	Voltage:	24 V DC SELV (21 – 32 V DC, e.g. via unchoked output of a KNX power supply
	Power consumption:	typ. 3 W / 6 W max. if the local bus interface is used (at 24 V DC)
	Connection:	Screw terminals: 0.5 – 4.0 mm ² single and stranded wire without ferrule 0.5 – 2.5 mm ² stranded wire with ferrule
	Response on bus voltage failure	
	Bus voltage only:	no reaction (IP communication possible / any attempt to change or to read KNX data points fails)
	Supply voltage:	no reaction (device shuts off completely)
	Response on return of voltage	
	Bus voltage only:	The KNX interface re-initializes itself. Default values as per presetting or as read out by the bus and updated are assigned to KNX datapoints.
	Supply voltage:	The devices re-initializes itself (boot procedure starts and lasts a few seconds. During booting, the green Power LED is off). Default values as per presetting or as read out by the bus and updated are assigned to KNX datapoints.
	LAN	
	Number:	1
	Connection:	RJ45 socket (10/100 MBit/s Fast Ethernet) 8-pole
	LAN connection:	straight with an Ethernet connection point (hub, switch, etc.), crossed with a PC
	Protocols:	TCP/IP (HTTP to port 80), UDP, POP, SMTP, SNMP, PPP
	IP addressing:	IP address, sub-net mask, gateway address and DNS server address presettable, DHCP possible (factory-set to active), autoIP
	a/b trigger input	
	Number:	1
	Signal voltage:	typ. 30 – 60 V AC (ringing tone signal of analog telephones) max. \hat{u} = 96 V AC
	Signal duration:	min. 40 ms
	Connection:	Screw terminals: 0.5 – 4.0 mm ² single and stranded wire without ferrule 0.5 – 2.5 mm ² stranded wire with ferrule
	Protection:	IP 20
	Mark of approval:	KNX
	Ambient temperature:	-5°C ... +45°C
	Storage temperature:	-25°C ... +70°C (storage above +45°C results in shorter lifetime)
	Fastening:	snap-fastening on DIN rail (no data rail required)
	RS232 (V.24)	
	Number:	1
	Connection:	9-pole sub-D connector (male)
	Max. transmission rate:	115.200 kbauds
	RS232 connection:	A modem is connected by means of an RS232 extension cable (one-to-one wiring). The length of the connecting cable should not exceed 15 m.

4 Technical data

Processor (LAN)

Type:	Netarm (Netsilicon)
Operating system:	Net OS
Architecture / speed:	32-bit RISC / 46 MHz
Memory:	16 MB RAM 8 MB Flash (internally extendible to 64 MB Flash max.) separately buffered RTC (real time clock) can be synchronized with Internet time server or with KNX system clock

Communication objects:	Max. 275 (256 freely available + 3 fixed objects for system clock + 1 collective object request groups + 15 collective objects)
Group addresses:	transmitting to bus: max. 256 receiving from bus: max. 250

Internal clock chip

Running reserve:	min. 12 hours
Clock error:	< 2 minutes per month
Power supply:	Gold-Cap capacitor supplied from external 24 V source

5 Hardware description

1. Connections

• Ethernet connection:

If it is intended to connect the IP central unit to a local network (LAN), possibly with a connection to the Internet, or also directly to a PC, an Ethernet link is required. For this purpose, the IP central unit is equipped with an 8-pole RJ45 socket as network interface.

This socket is connected by means of a twisted-pair (TP) cable which – depending on the devices to be connected with one another – must be designed as follows:

- as a one-to-one link cable (patch cable) in case of connection to the 'normal' or auto-MDIX port of a network distributor (e.g. hub, switch, router),
- as a crossover cable in case of direct connection to a PC (point-to-point link).

The Ethernet lines used should correspond at least to the Cat.5 standard. The general guidelines governing the installation of Ethernet lines must be observed.

The IP central unit supports the 10BaseT (10 Mbit) and 100BaseT (100 Mbit) standards.

When the physical connection with a network distributor or a PC is established, the yellow Link / LAN LED on the device front panel lights up when the supply voltage is applied. This LED flickers when data telegrams are being received via the Ethernet interface.

The logic link with the network will be established only after allocation of an IP address. The procedure of allocating an IP address is described in greater detail in chapter 2 "Configuration".

• Modem connection:

Depending on the type of connection, an analog modem or an ISDN modem with serial RS232 interface can be connected to the IP central unit for Internet dial-in. The connection is made by means of a one-to-one interconnecting cable which should not be longer than 15 m.

As soon as an online link has been established by or with the IP central unit, the yellow Online / Modem LED on the front panel of the device lights up. In this case, the exchange of data is in progress and online or phone call charges are accruing. The modem is controlled by means of internationally standardized AT commands so that a large variety of current modems can be connected. Further configuration settings, especially the definition of the type of modem used, are explained in chapter 2 "Configuration".

The connection of a modem to the local telephone network is manufacturer-specific and the corresponding instructions should therefore be inferred from the documentation supplied with the modem used.

• Telephone connection:

The IP central unit is equipped with an analog telephone trigger input. Depending on the type of connection, this input can be used for triggering an Internet dial-in 'from outside'. This function is useful with time- or volume-based Internet charges (cf. 1.2 "Types of connection").

The IP central unit monitors the signal voltage at the a/b input for a ringing signal. If a ringing signal is detected, the central unit establishes a connection with the Internet via the configured link.

As the ringing signal is only 'overheard' by the unit without answering the call, no call charges are accrued.

There is no calling line identification (CLI) via the a/b terminals. Each call coming in on the connected line is therefore interpreted as a trigger signal. For this reason, the connected analog telephone line should have a phone number of its own. This can be achieved with an independent telephone line or a separate analog extension in a branch exchange.

The telephone line is connected to the IP central unit by means of the screw terminal pair "a/b".

5 Hardware description

The line itself is usually connected to the terminals of a PBX (cf. Fig. 1).

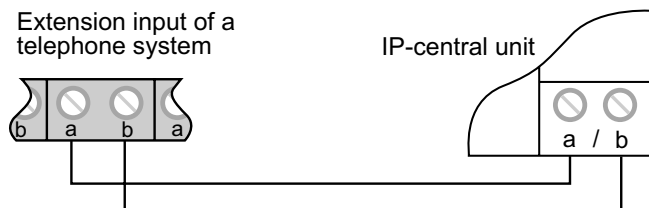

Fig. 1: Connection to the terminal strip of a PBX

For reasons of clarity, the polarity of the line should be observed. On principle, the polarity of an analog telephone line connected to the IP central unit is of no importance.

- Connection of the supply voltage and bus connection:
 The IP central unit needs an external supply voltage of 24 V DC for operation. This supply voltage can be derived, for instance, from the unchoked voltage output of a KNX power supply (21 – 32 V DC)
 The bus is connected with the bus connection terminal.

2. Network configuration

The main role of the IP central unit is to act as a Web server and to make the contents of its Web pages available to the user. For this purpose, the IP central unit is either integrated into a local area network (LAN) or connected with the Internet via suitable gateways or modems.

The user can then access the Web server of the IP central unit via the Web interface of the browser (Microsoft InternetExplorer 5.5 and higher) installed on his PC. The access to the site and the transfer of the Web pages is enabled by the Hyper Text Transfer Protocol HTTP used all over the world.

By default, this protocol is part of the Transport Control Protocol – Internet Protocol TCP/IP which ensures the safe, hard- and software-independent communication of data worldwide. It is this Internet Protocol which permits combining an undefined number of individual networks (e.g. private networks) into a global network (e.g. the Internet). It permits the exchange of data between any two network subscribers in any two private networks (cf. Fig. 2). The physical structure of the networks or the transmission system (Ethernet, DSL, ISDN, etc.) is of no importance. The networks themselves are physically (and most often also logically) interconnected by means of suitable network nodes (routers, modems, bridges).

- Straight LAN connection

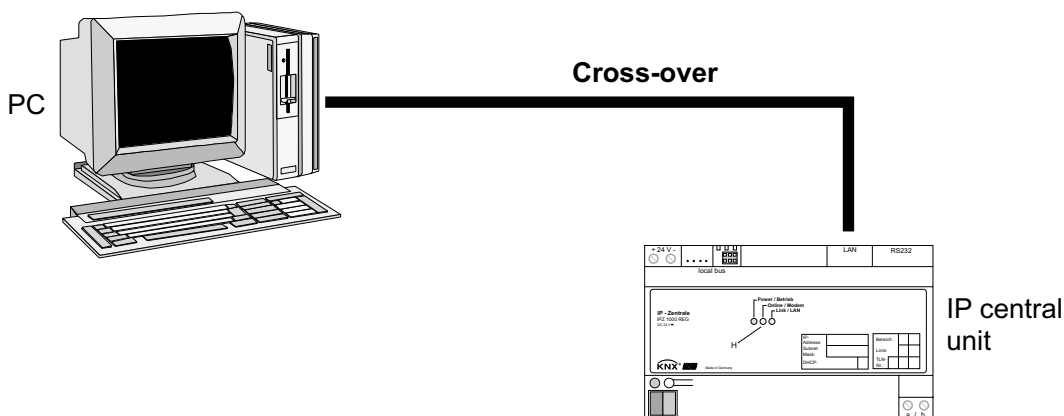

Direct connection of a PC with the IP central unit by means of a crossover cable (transmit and receive lines crossed over / special network cable required) In this type of connection, only the PC directly connected with the central unit has access to the device. This connection is recommended for commissioning and testing purposes.

5 Hardware description

- LAN connection with more than one PC via network distributor

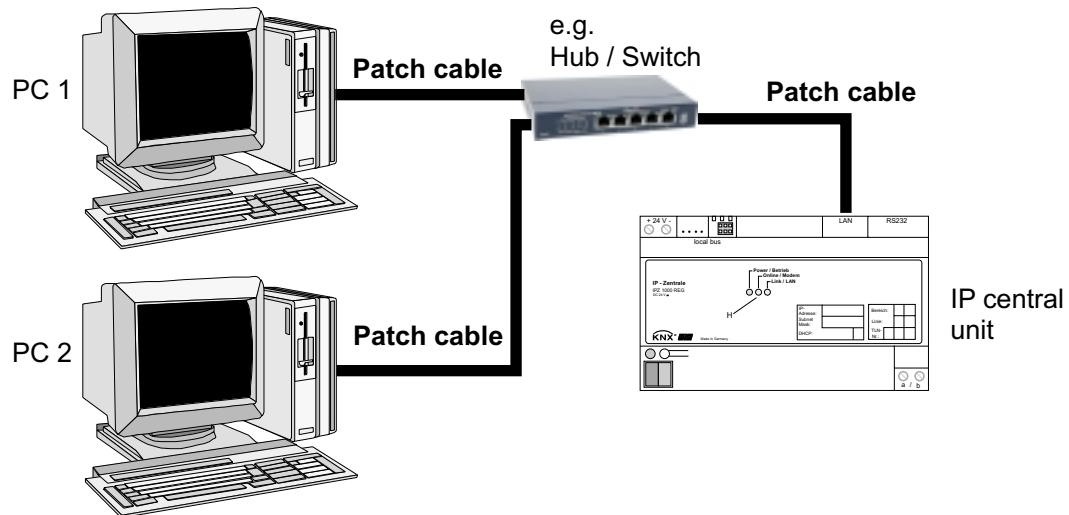

This type of connection permits access to the IP central unit by several PCs of the local area network. The physical connection of the network components is realized by means of one-to-one patch cables.

Information concerning the use of several PCs (clients):

The IP central unit can establish a maximum of 10 IP connections (sessions) at the same time, i.e. that a maximum of 10 clients can load data from the central unit (the server) at the same time. It should be noted, that Microsoft's Internet Explorer sometimes launches several logic IP sessions at the same time in order to accelerate the loading process.

In spite of this strategy, the static viewing of a loaded website (no data download) is not dependent on a certain number of sessions.

- LAN connection with permanent connection to the Internet

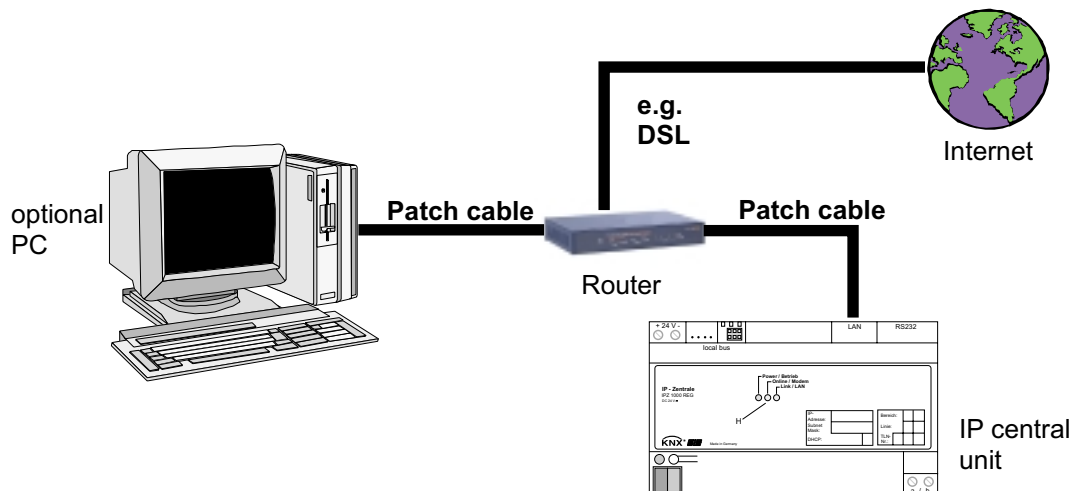

With the help of a router or a proxy server, a local Ethernet (LAN) makes a permanent Internet connection available. This type of connection makes sense, for instance, in case of a DSL flat-rate or a dedicated telephone line for the Internet.

The IP central unit can ensure by means of keep-alive telegrams that the link is not disconnected by the router or the service provider (ISP).

Even after a forced disconnect by the service provider (depending on subscriber rate often after 24 hours of permanent connection) a permanent connection with Internet can thus be upheld.

The access "from outside" is effected from an external PC with the browser as user interface and by entering the password ensuring user authorization. After successful log-in, the Web page of the IP central unit is displayed. The KNX system can be controlled and monitored by direct access.

To enable the access to the IP central unit from the Internet, the router or the proxy server must redirect external HTTP requests addressed to the IP central unit inside the local area network. For redirection, the NAT (Network Address Translation) function can be used in the router.

In this mode, the router translates HTTP requests from the Internet to the local IP address of the IP central unit. HTTP request are directed to port 80 of the central unit. Further basic notions and configuration settings are discussed in chapter 2 "Configuration".

5 Hardware description

- LAN connection with Internet dial-in connection after modem request

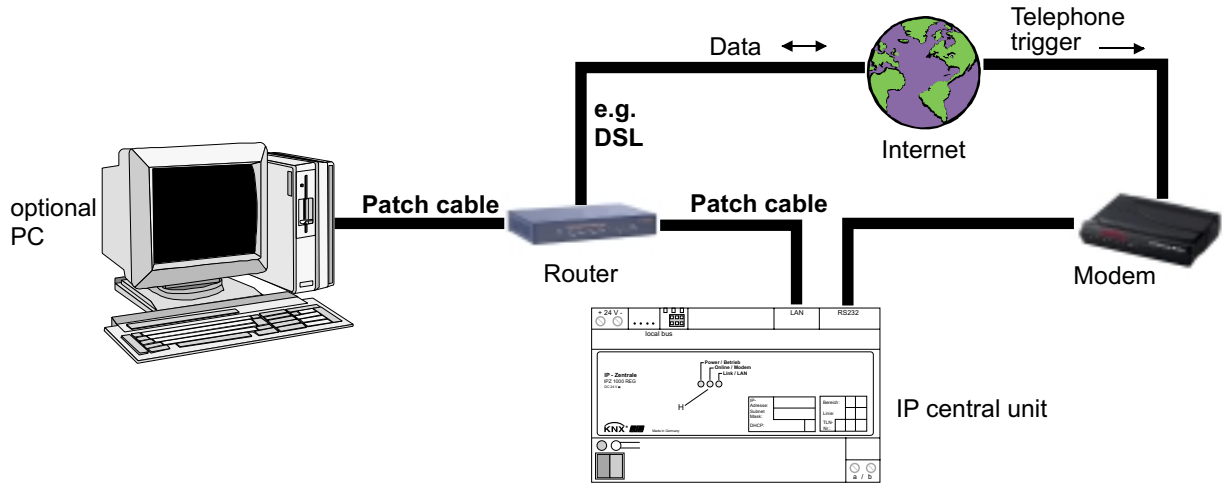

With the help of a router or a proxy server, a local Ethernet (LAN) establishes a connection with the Internet after a modem request. This type of connection makes sense, for instance, in case of a DSL connection with a time- or volume-based rate. The trigger call via a modem connection (simple call to the telephone number of the modem) causes the IP central unit to establish a link with the Internet via its LAN interface. As soon as the link is established, the IP central unit can be accessed. The call to the modem does not establish a telephone contact so that no call charges will accrue. The modem simply detects the ringing signal and informs the IP central unit accordingly. In this case it is recommended to use modems permitting identification of the calling line (CLIP function). The feature can be used as a trigger call authorization function. When the CLIP function is active, only trigger calls from telephone numbers known to the IP central unit will be accepted. In this case, the transmission of the caller's telephone number must be supported by the telephone line.

- LAN connection with Internet dial-in after telephone request / triggering

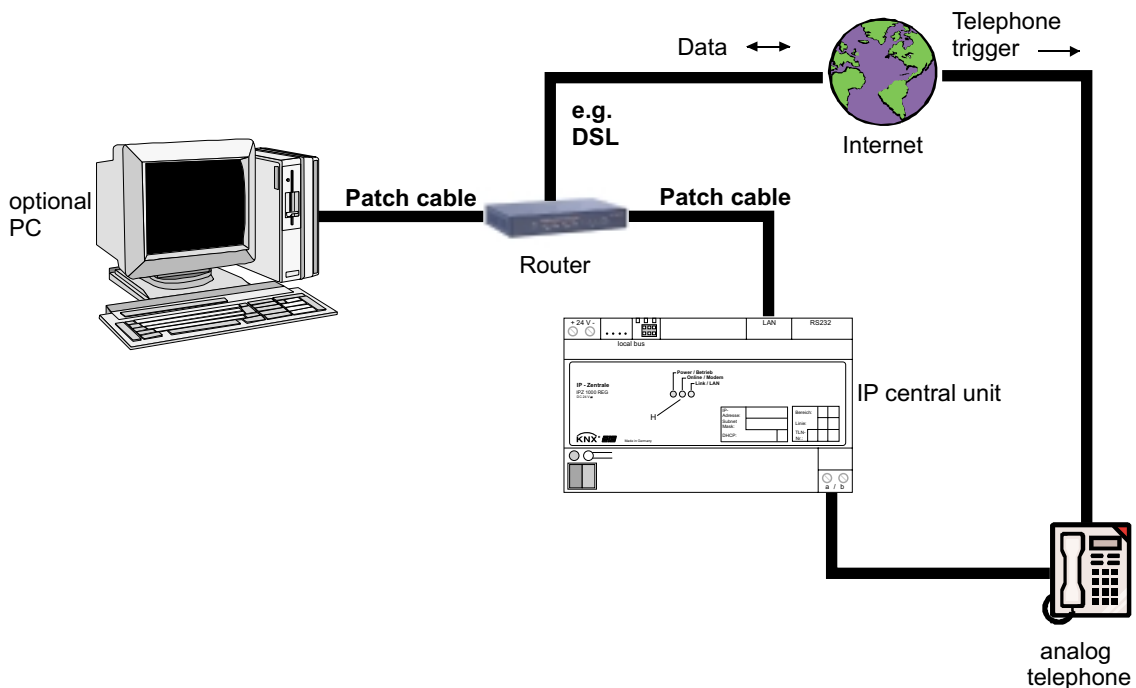

With the help of a router or a proxy server, a local Ethernet (LAN) establishes a connection with the Internet after a telephone request. This type of connection makes sense, for instance, in case of a DSL connection with time- or volume-based rate. The trigger call via the analog a-b input causes the IP central unit to establish a connection with the Internet via its LAN interface. As soon as the connection is established, the IP central unit logs in with the directory server. The call arriving at the a-b port does not establish a telephone contact so that no call charges will accrue. The IP central unit merely detects the ringing signal at the a-b terminals. There is no calling line identification (CLI) via the the a/b terminals. Each call coming in on the connected line is therefore interpreted as a trigger signal. For this reason, the connected analog telephone line should have a phone number of its own. This can be achieved with an independent telephone line or a separate analog extension in a branch exchange.

5 Hardware description

- Operation with or without LAN connection and Internet dial-in by a modem

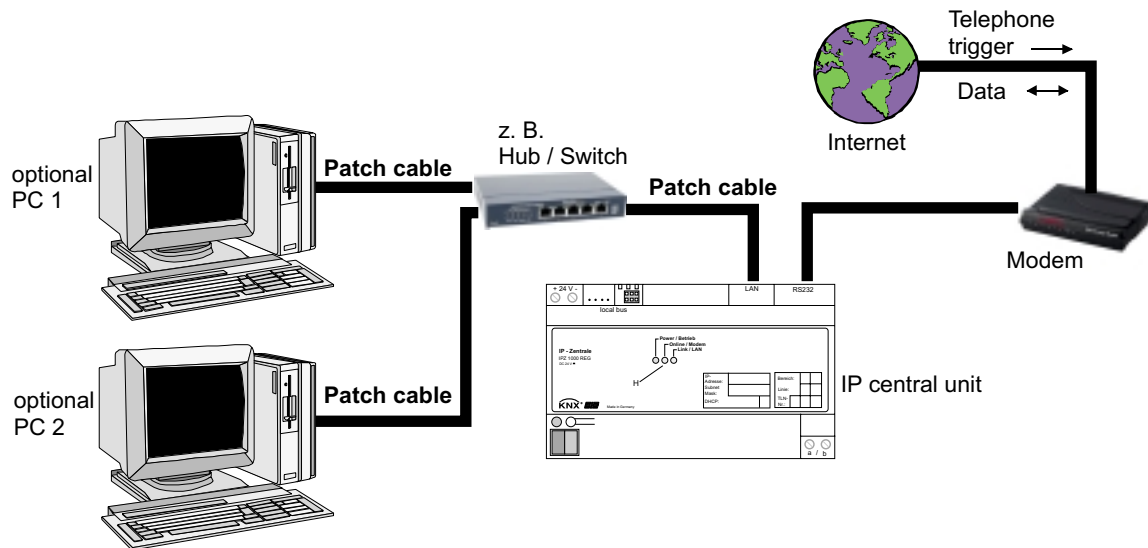

There is no Internet connection via the LAN. If needed, the LAN interface therefore only offers access via PC in the local area network.

The trigger call via a modem connection (simple call to the telephone number of the modem) causes the IP central unit to establish connection with the Internet via its LAN interface. For this purpose, the IP central unit dials in with the specified service provider (PPP: Point-to-Point Protocol) as soon as the trigger call is terminated. As soon as the link is established, the IP central unit can be accessed.

The trigger call to the modem does not establish a telephone contact so that no call charges will accrue. The modem merely detects the ringing signal and informs the IP central unit accordingly.

An Internet dial-in by the IP central via modem causes call charges and – depending on the online use rate – additionally also online charges to arise.

In this case, it is recommended to use modems permitting identification of the calling line (CLIP function). The feature can be used as a trigger authorization function. When the CLIP function is active, only trigger calls from telephone numbers known to the IP central unit will be accepted. In this case, the transmission of the caller's telephone number must be supported by the telephone line.

3. Configuration Settings

The IP central unit is configured by a plug-in integrated in the ETS. The configuration dialog appears after starting the plug-in and after clicking on the button "Configuration" in the righthand menu bar. As an alternative, the device configuration can be activated by selecting the menu item "Device configuration" in the context menu (right mouse click in left-hand tree view) or by clicking on the button in the upper menu bar. The configuration dialog consists of nine pages with parameter settings for the unit that are described in the following sub-chapters.

The screenshot shows the 'Device configuration' dialog box with the 'Modem/Internet' tab selected. The 'IP configuration' sub-tab is active. The following fields are visible:

- Serial number: 30000142
- Device description: IP central unit 1
- DHCP
- IP address: 0 . 0 . 0 . 0
- Subnet mask: 0 . 0 . 0 . 0
- Default gateway: 0 . 0 . 0 . 0
- DNS server: 0 . 0 . 0 . 0

At the bottom of the dialog, there are four buttons: 'Use standard parameters', 'OK', 'Cancel', and 'Apply'.

5 Software description

1. Projecting and ETS plug-in

If the IP central unit is to work as a visualization tool and as an operation or control unit for a KNX system, the device needs precise information about the existing KNX installation. A plug-in specially developed for the IP central unit 'translates' the projecting data into a separate object model which is loaded into the IP central unit. The object model contains all KNX data points and parameter data and acts as the logical interface between the network and the installation bus.

Each IP central unit in the ETS project has its own object model in the ETS database.

The user operates the object model created in the ETS by the systems administrator via the browser interface and has the possibility of changing or of viewing the state of the different data points. A change or an extension of the object model and thus of the data structure as such can only be made in the ETS.

The ETS plug-in of the IP central unit is an integral part of the product database (no external plug-in). The plug-in can be used in the ETS from version 1.3 and in the ETS 3 from version 3.0 onwards. With the ETS 3, the plug-in is installed by a normal import of the product database in the *.VD3 format.

With the ETS 2, the plug-in is installed in two steps, at first by running the installation program in the *.EXE format and by the subsequent import of the product database in the *.VD2 format.

It is basically recommended to install the latest ETS patches available.

Instructions for the use of ETS 2:

Compared to the ETS 3, the plug-in itself and thus the complete projecting and commissioning environment is absolutely identical.

With the ETS 2, only the data of the object model and the device configuration are not stored in the ETS database, but in a separate external file.

When the plug-in is started by opening the parameter menu in the ETS, a dialogue is displayed in which the start options of the plug-in are defined.

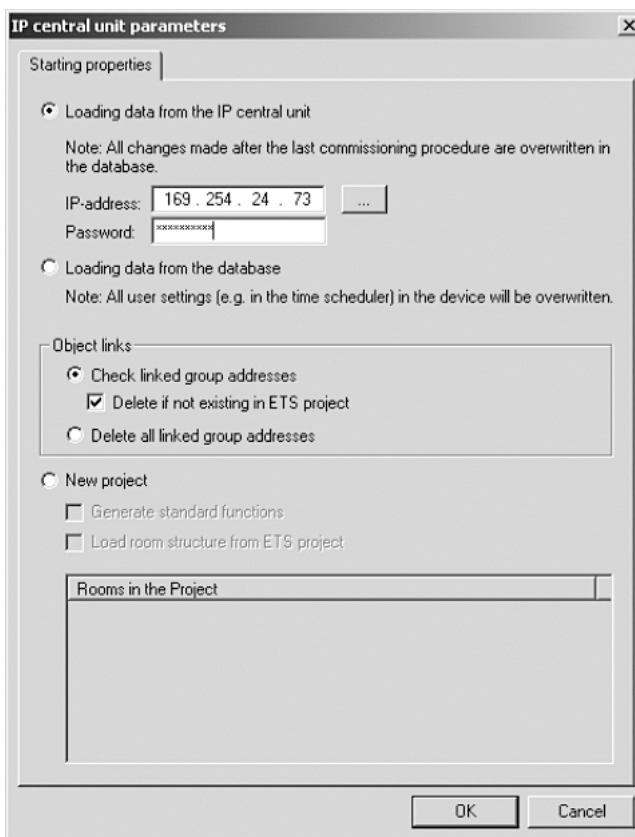

By selecting any of the following three options, the object model of the IP central unit is initialized after pressing "OK".

5 Software description

2. The ETS Plug-in

The plug-in is started by opening the parameter view in the ETS. After readout of an existing object model from the specified source or after creation of a new model, the projecting interface of the plug-in is opened.

The projecting interface is divided into four main parts (cf. Fig. 5). The size of each part or of the entire window can be changed at will by clicking and dragging with the mouse.

In the upper left part, the object model is represented in form of a tree structure with all building services, rooms, functional groups, KNX datapoints and linkage functions. The error report is also displayed in this window.

The sector below (B) shows the group addresses existing in the ETS project and read out from the database. A link between the group addresses and the entry fields for KNX datapoints can be established by drag & drop from this part of the window. Changing or deleting of existing group addresses in the plug-in is not possible.

The upper right part of the window (C) contains parameter sets and links of group addresses for the elements selected in the window on the left. The lower right part of the window (D) displays direct help texts describing the marked parameter element in the window above and shows the conflict descriptions of the error report.

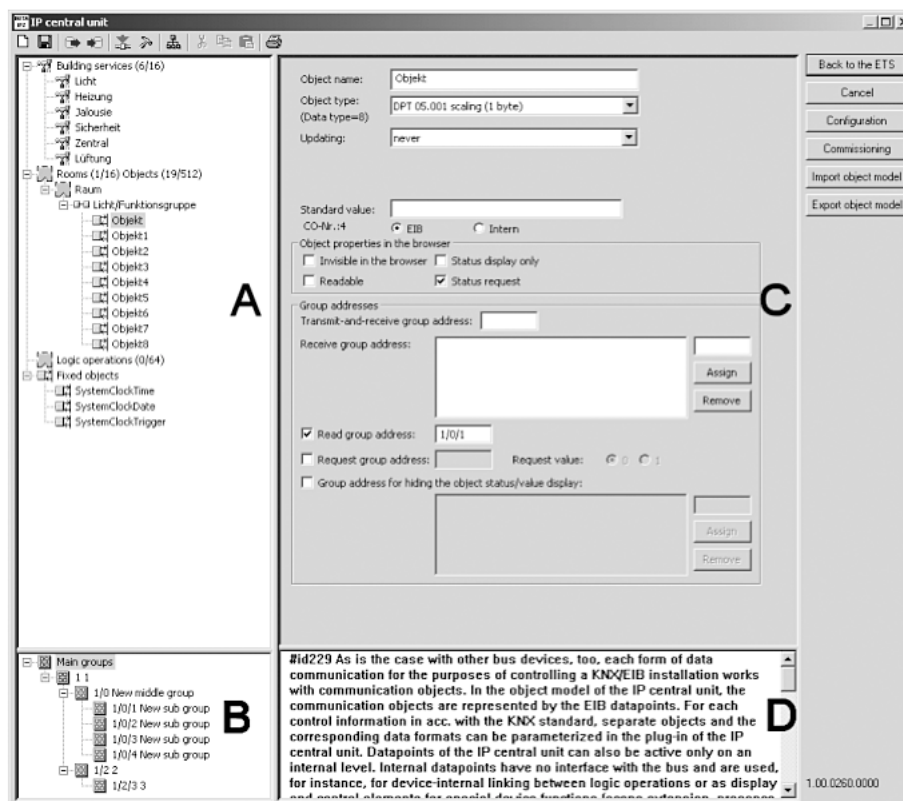

5 Software description

3. The user interface

The user interface of the IP central unit is operated like any other Internet page. It has graphical navigation, control and display elements that can be selected with the mouse pointer and edited. Text or values are entered by means of the PC keyboard.

Fig. 4 shows the basic view of the user interface in the Web browser after successful user log-in.

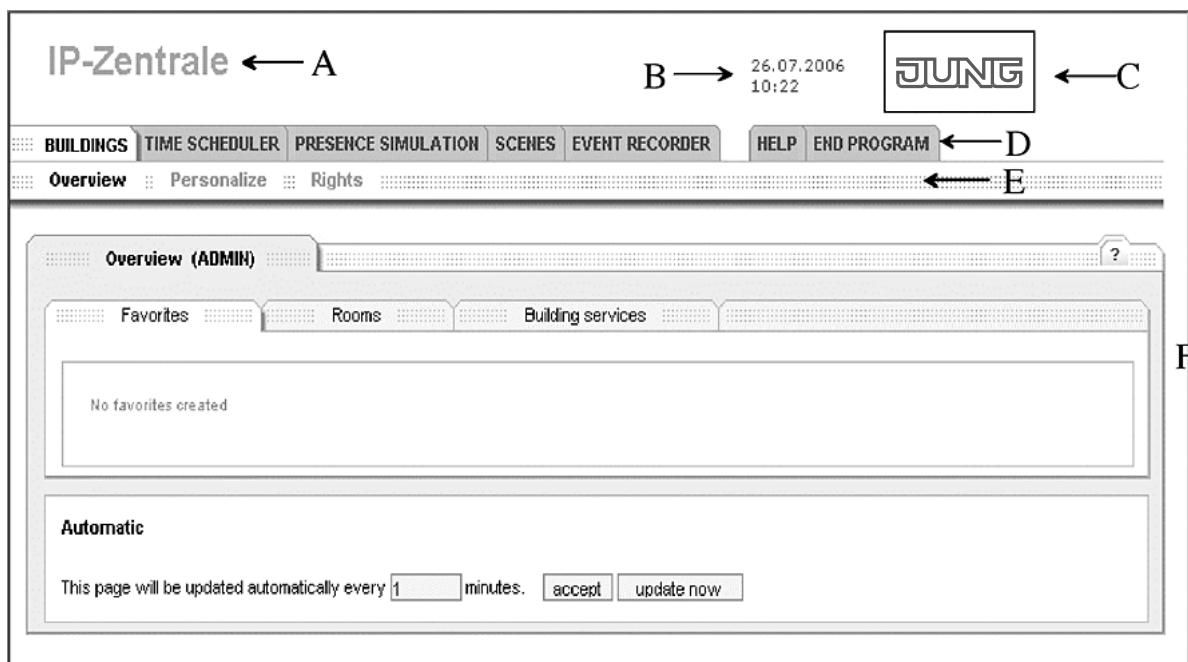

The Web browser window is basically divided in two sections. The upper part contains the information section and the main navigation elements. The lower part contains the workspace.

- Description of the IP central unit in information section (A):

A description of the IP central unit is displayed in the upper right corner of the Web browser. The description is entered in the ETS building or topology view under the properties of the projected IP central unit (double-click or context menu 'Properties') in the "Description" text field. During programming of the IP central unit, this description is stored in the memory of the device and displayed in all views of the Web browser – exactly as specified in the ITS. To avoid any uncontrolled access either by the plug-in or by the gateway browser, this designation should be chosen at the project start under mnemonic aspects.

- Actual system time of IP central unit (B):

The upper line indicates the actual system time at the time when the page is called up. The system time is used internally for the execution of time-controlled sequences. A mouse click on the line displays the settings of the system. As the browser view is static, the displayed time of day is stationary. The actual system time is displayed only after calling up a new page or during a data update.

- Manufacturer's logo (C)

- Main navigation (D):

The main navigation permits selecting the individual applications of the IP central unit. After log-in, the first tab "Building overview Favorites" is displayed.

The following applications are available:

- Buildings
- Time scheduler
- Presence simulation
- Scenes
- Event recorder
- Help

- Subnavigation (E):

Dependent on the selected application in the main navigation (D) and dependent on the respective work step, the subnavigation displays a selection of submenus. These submenus help with further navigation.

- Workspace (F):

The workspace presents the corresponding information about the selections made in the main and the subnavigation. In the workspace, settings can be viewed and changed.

For more detailed information, please download the complete product description from our web-page !

1

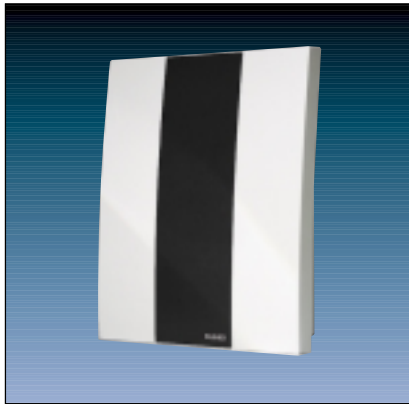

2

	Ref.-No.
KNX Alarm central unit	EAM 4000
ETS-product family:	Alarm system
Product type:	Alarm central unit

3

The alarm central unit is a modern alarm system using the KNX system. Detailed knowledge about planning, designing and commissioning of alarm systems are absolutely required.

The alarm central unit is a modern intruder alarm system using the KNX system for the transmission of information. It keeps an object under surveillance and detects and signals intrusion attempts. The system is no substitute for any mechanical safeguarding devices which prevent intrusion into your property.

You can use the alarm central unit as a comfortable extension for any existing KNX installations.

The alarm central unit has been designed in compliance with VdS (German Association of the Damage/Loss Insurers) guidelines.

The functionality of the device is dependent on the parameters of the software application. To install and configure the software it requires at least the ETS 2 1.2a version.

By using the KNX the additional wiring and cabling effort of a separate alarm system can be reduced to a minimum. This is achieved by using sensors, i.e. movement detector not just purely for lighting control or alarm systems.

4

Technical data

Input supplying

Voltage:	230 V AC, $\pm 10\%$, 50/60 HZ	
Power consumption:	max. 24 W	
Current secondary:	max. 50 mA; during changing process approx. 200 mA	
Fuses:	F1 = T 100 mA (5 V supply of central unit)	
	F2 = T 100 mA (12 V power supply)	
	F3 = T 100 mA (supply for telephone dialer)	
	F4 = T 3.15 A (main fuse 230 V)	
	F5 = T 3.15 A (protection of accumulator)	
Output voltage for alarm device:	SELV 12 V DC, $\pm 2\%$	
Max. capacity of outputs:	Telephone dialer:	100 mA
	12 V supply	100 mA
	Sirens/flash in total	1.6 A (electronic overload protection)
Capacity of relay:	SELV 12 V (AC/DC), 5 A (min. 30 mA)	
Storage battery:	12 V / 1.2 Ah	
Charge voltage:	approx. 13.4 V	
Charge current:	approx. 150 mA	
Supply KNX:	SELV 21 V – 32 V	
Power consumption:	max. 240 mW	

Connection

KNX:	KNX connection block
mains:	screw terminals up to 1.5 mm ²
Spare accumulator:	12 V/1,2 Ah, ref.-no. DAS 4512

4 Technical data

Protection:	IP 20
Operation temperature:	-5°C ... +45°C
Storing temperature:	-25°C ... +70°C
Dimension:	210 x 270 x 73 mm
Weight:	approx. 1500 g (including accumulator)
Event memory:	min. 80 events per security area 40 events for each fire and alarm
Length of wires:	to alarm devices: 100 m at 0.8 mm diameter to telephone dialer: 200 m at 0.6 mm diameter to wired detectors: 200 m at 0.8 mm diameter to sabotage line: 600 m at 0.8 mm diameter
Resistance of wired detectors:	max. 1 kOhm

5 System configuration:

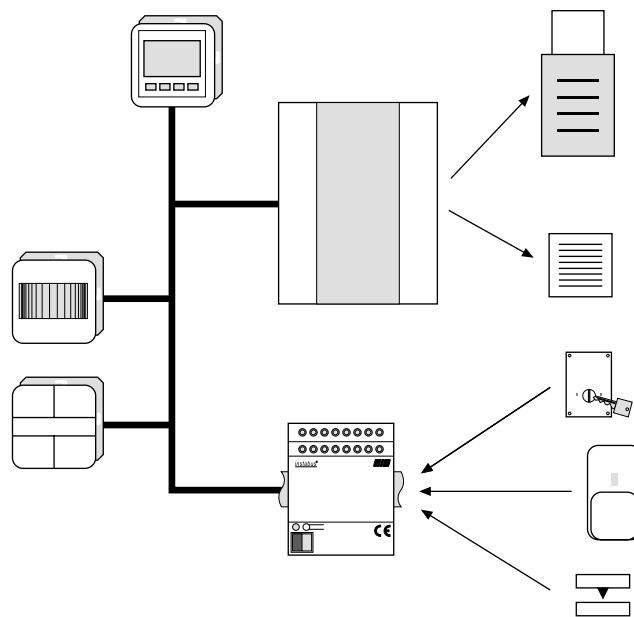

Note: For the planning and programming of the whole system it is absolutely necessary to have the knowledge about alarm systems and the specific terminology as well as a product training on the alarm central unit.

Functional features:

- Up to 160 sensors can be administrated and integrated in up to 4 separate safeguarding areas.
- All sensors are connected via the KNX to the alarm central unit. Hence, the identification and monitoring of all sensors is obtained.
- All events (as arming, alarm, failure) are saved with time and date in a protocol.
- Alarm devices (as siren, flash or telephone dialer) can be connected directly to the alarm central unit or can be controlled via KNX.
- The alarm central unit has an integrated floating storage battery which, in case of mains failure, guarantees a back-up time of approx. 12 hours.
- The displaying and operation is done by external KNX devices like Info Display, push-buttons, etc. In one armd area several operation units can be applied.
- An additional local sensor input can be used to protect the location where the alarm central unit is mounted.
- Furthermore, a relay contact can be used to connect additional alarm devices.

The alarm central unit is developed for different applications. It starts in residential buildings with the protection of the outside body (windows, doors) and the interior and ends in office buildings, whereby up to 4 different security areas can be defined and protected separately or linked together.

5

Alarm system configurations:

Due to many different parameterisation options, the KNX alarm central unit can be used in various objects – from the detached family house with outer shell and inner room safeguarding up to the office building where up to four arming areas (AA) can be safeguarded individually or in groups linked up with one another.

The following list shows the basic configurations which may also be combined with one another:

1 x inner room, 1 x outer shell (nested)*:

Detached family house, flat.

(AA1 = outer shell, AA2 = inner room;

AA 1 can be armed individually or together with AA2).

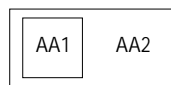

2 x [1 x inner room, 1 x outer shell (nested)*]:

Two-family house, house with granny flat,

2 separate safeguarding areas (workshop with flat).

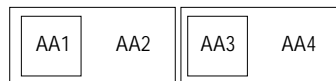

Up to 4 separate areas:

Shopping arcade, holiday houses, hotel/pension, trade fair/exhibition halls.



Up to 4 separate areas (cascaded)**:

Office/industrial building, sports hall.

(AA4 only to be armed if AA1 to AA3 have already been armed).

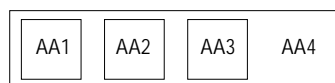

* nested: The subordinate area is armed together with the higher-order area.

** cascaded: The higher-order area can only be armed if the subordinate areas have already been armed.

Fire and attack detectors:

Regardless of the configuration of the system, the fire and attack areas are always active. If a fire or attack detector is activated, the system will immediately set off an alarm, regardless of what its state is.

As a special variant, the alarm central unit can also be solely used for “attack” and “fire”.

Security

Accessories



2

	Ref.-No.
Outdoor siren with flash light	DAS 4110
Rated voltage: 12 V DC	
Protection: IP 34	
Indoor siren	DAS 4120
Rated voltage: 10 – 28 V DC	
Protection: IP 32	
TC Plus KNX analog	2601
(more details please refer to pages 217/218)	



2

	Ref.-No.
Automatic alarm dialer, Digital	only on special request
The digital automatic dialer provides a silent transmission of an alarm or malfunction to a permanent available security service.	
Automatic alarm dialer, Analog	FUS 4620
The analog automatic dialer provides a silent transmission of an alarm or malfunction.	
4 alarm inputs	
4 outputs to be switched via phone	

1



DAS 4300 A



DAS 4210

2

	Ref.-No.
Surface mounted key switch, For activating and deactivating of alarm systems Front plate material: Pressure casted aluminium	DAS 4300 A
Flush-mounted key switch Front plate material: Lost-wax casted aluminium (profile cylinder lock is not included!)	DAS 4300 U
Movement detector Passive infrared detection principle Detected area: 90° (volumetric) 34 double zones in 3 levels Maximum detected area approx. 15 x 5 m	DAS 4210

1

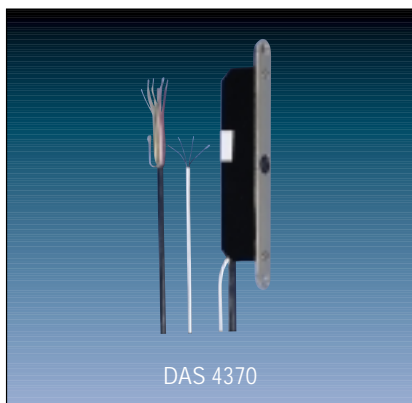

DAS 4370



DAS 4360

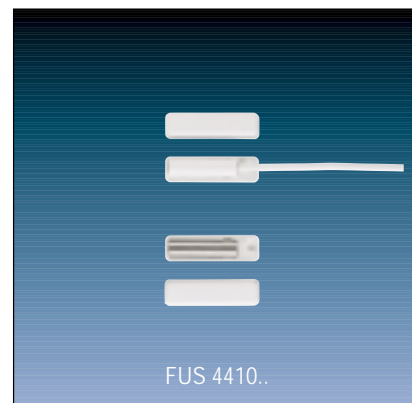

FUS 4410..

2

	Ref.-No.
Locking unit	DAS 4370
Frame joint switch contact	DAS 4360
Glass-break sensor, passive	FUS 4415 WW
Magnet contact	
white	FUS 4410 WW
brown	FUS 4410 BR

Synoptics

1

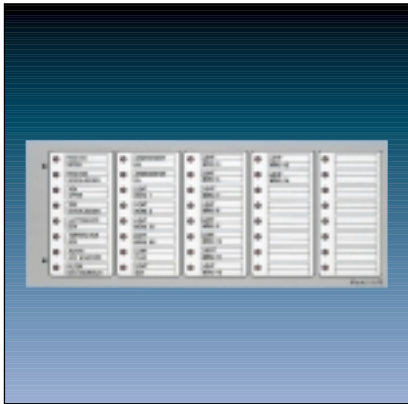

2

Signal panel L 40

Ref.-No.
2405

3

The KNX signal panel allows to monitor the actual operating states of an KNX system and consists of 40 LED. The data exchange between the KNX and the signal panel takes place via an electronic control system. This is provided in specially designed flush or surface mounted panel boxes with appropriate power packs. The signal panel is connected to the control system via a 20-pole parallel bus. If the panel is used in an external performance the control system is also an external module (Ref.-No. 2430 REG). The functions of the signal panel are programmed by using the special EIBTAB-software. To assign the functions to the LED, description fields are provided to each LED.

1

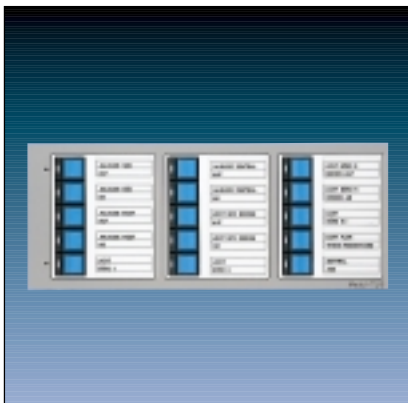

2

Operator panel TL 15

Ref.-No.
2410

3

The KNX operator panel allows to monitor or have direct influence on the actual operating states of an KNX system and consists of 15 push-buttons with 15 integrated LED. The data exchange between the KNX and the signal panel takes place via an electronic control system. This is provided in specially designed flush or surface mounted panel boxes with appropriate power packs. The operator panel is connected to the control system via a 20-pole parallel bus. If the panel is used in an external performance the control system is also an external module (Ref.-No. 2430 REG). The functions of the operator panel are programmed by using the special EIBTAB-software. To assign the functions to the 15 push-buttons and 15 LED, description fields are provided to each element.

4 Technical datas:

External supply	
Voltage:	5 V DC
Power consumption:	max. 1.5 W
Connection:	20-poles jumper connector
Operation temperature:	-5°C ... +45°C
Storage temperature:	-25°C ... +55°C

1

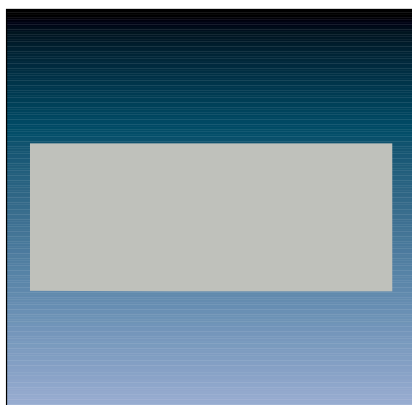

2

	Ref.-No.
Blank plate, neutral	2415
for flush or surface mounted panel boxes	

Synoptics

1



2

	Ref.-No.
Flush (U) mounted panel boxes	2422 U ... 2426 U

1



2

	Ref.-No.
Surface (A) mounted panel boxes	2422 A ... 2426 A

3

The panel boxes are equipped with an integrated power supply, electronic control system and, of course, a BCU. Dependent upon the size of the boxes it is possible to insert two up to six signal or operator panels in various combinations. The panels are connected to the panel box with a 20-poles parallel bus connector included in the delivery. The functions of the signal or operator panel are programmed by using the special EIBTAB-software. Only the physical address has to be given by the ETS.

4

Technical data

External supply

Voltage:	230 V AC
Power consumption:	max. 20 W
Connection:	clamp bar

Bus supply

Voltage:	24 V DC (+6 V / -4 V)
Power consumption:	max. 150 mW
Connection:	KNX connection block
Operation temperature:	-5°C ... +45°C
Storage temperature:	-25°C ... +55°C

1



2

	Ref.-No.
Electronic control module	2430 REG
Series embodiment (SE)-device (8 units)	

3

In combination with the power supply 2447 REG the control module is used for controlling up to six signal or operator panels. The module has an integrated BCU and interface to the KNX, therefore this device is the link between KNX and the synoptic modules. The functions of the signal or operator panel KNX are programmed using the special EIBTAB-software. Only the physical address (no application) has to be given with the ETS using the special dummy application (ETS-path: system components, line coupler).

4

Technical data

External supply

Voltage:	230 V AC
Connection:	clamp bar

Bus supply

Voltage:	24 V DC (+6 V / -4 V)
Power consumption:	max. 150 mW
Connection:	KNX connection block
Operation temperature:	-5°C ... +45°C
Storage temperature:	-25°C ... +55°C
Mounting:	onto DIN rail 35 x 7.5

Synoptics

1



2

	Ref.-No.
Power supply 5 V	
for Signal/operator panel	2447 REG
Series embodiment (SE)-device (8 units)	

3

The power supply generates an output voltage of 5 V DC and is used for up to six signal or operator panels. If these panels are installed outside of the panel box, the power supply is connected additionally with the control module 2430 REG via a 20-pole parallel bus connector.

4

Technical data

External supply

Voltage: 230 V AC
Connection: clamp bar

Input

Number: 6
Performance: 20-pole parallel bus connector
Rated voltage: 5.1 V DC (± 0.1 V)
Rated current: 2 A (all outputs together), short-circuit protected
Operation temperature: $-5^{\circ}\text{C} \dots +45^{\circ}\text{C}$
Storage temperature: $-25^{\circ}\text{C} \dots +55^{\circ}\text{C}$
Mounting: onto DIN rail 35 x 7.5

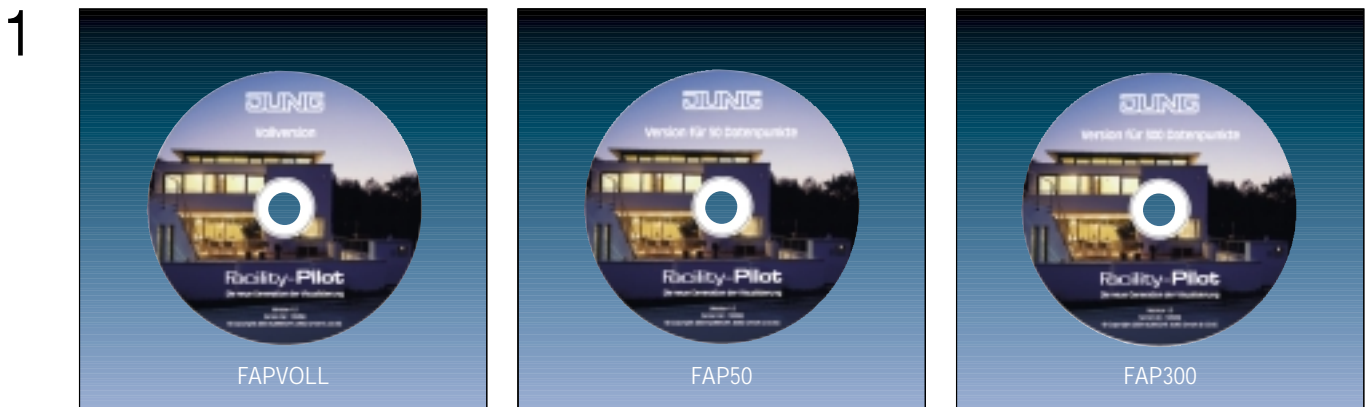

2

	Ref.-No.
Facility-Pilot FAP	
Software versions	
Planner version	FAP-PLANER-GB
50 data point version	FAP50-GB
300 data point version	FAP300-GB
Full version	FAPVOLL-GB
Software versions for network application (only with the FAP full version)	
For 1 – 4 PC	FAPCLIENT14-GB
For 5 – 9 PC	FAPCLIENT59-GB
For 10 – 24 PC	FAPCLIENT1024-GB
OPC editor	OPC-EDITOR

3 System requirements

Windows versions: 98 SE, ME, 2000, XP, Internet Explorer 6, DirectX (version 9b), Acrobat Reader.
 For the installation under Windows 2000 and XP administrator rights are required.
 Internet Explorer 6, DirectX (version 9b), Acrobat Reader are delivered with the FAP CDROM.

Recommended order of installation:

1. Internet Explorer
2. DirectX
3. Facility Pilot
4. Acrobat Reader

Note: The software is locked with a software key and must be activated within 20 days after the installation !

Hardware requirements:

- Pentium IV or equal
- RAM 256 MB
- Free space on hard disk 40 GB (dependent on the data processing / archives)
- Resolution 1024 x 768
- Colours min. 16 bit / pixel
- Interface serial or USB for the application of FALCON
- Internet connection (optional) when e-mail notification used

5 Visualization / Facility Management

Facility Pilot – the new open visualisation generation

The JUNG Facility-Pilot is a flexible, interactive software for extensive visualisation and control of the building system technology KNX. Its areas of application extend from many different industrial applications through to up-market residential buildings. The software consists of individual modules (Fig. A) such as the EIB editor, process model, visualisation editor and a comprehensive system control.

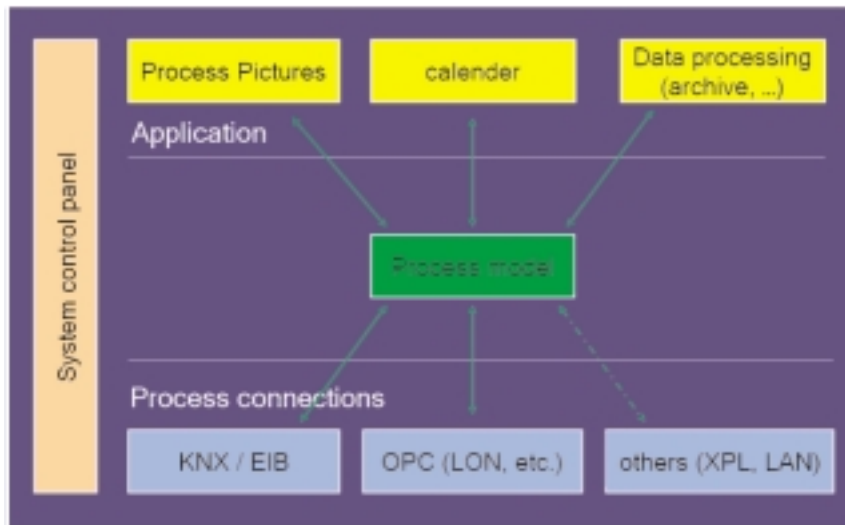

Fig. A

With the modular JUNG Facility-Pilot software system, a total solution for building management technology has been developed which opens up the topic of visualisation to a broad spectrum of users and moreover contains pioneering developmental steps as regards additional functionality such as access via the Internet. It is therefore not purely visualisation software but a comprehensive program which considerably simplifies operation with KNX and its connection with other bus systems.

This also fits in with the complete philosophy of the system which makes it possible to set up displays for process characteristics or archives for value characteristics and events without programming; even controller functions can be configured via drag & drop. And for specialists, there is also the possibility of visualisation programming if there are special requirements which are not covered by the system as standard. The complete programming environment for BASIC scripts is a prerequisite for this.

KNX installations in private residential buildings can likewise be enhanced with the system as in the commercial sector since specific modules help to convert almost every technical requirement both quickly and economically – from the fault indication system to the entire technical building management system, culminating in the analysis of consumption data.

The navigation of the different modules is very easy due to the clear structured system control panel (Fig. B). This system control panel provides a fast overview of the whole system with the individual modules, documents and project management. The Facility-Pilot brings flexibility, greater user convenience and easy handling to bus system management. The visualisation and control assist the user with interactive help and extensive documentation.

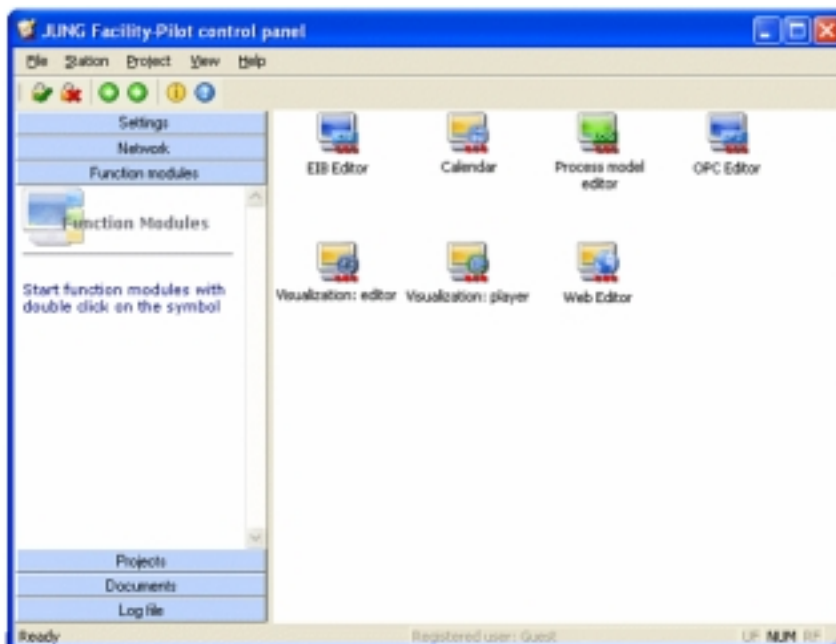

Fig. B

5 Visualization / Facility Management

When developing the system, attention was directed at economic efficiency since logic modules or year time switches can be committed in many installations as the Facility-Pilot takes over these functions. The simple operation pays off quickly for the user. Tools and assistants support the project engineers in their work while the end user has a high level of user friendliness and flexibility for his KNX installation. The technology remains discreetly hidden in the background.

Internet connection via integrated web-server will increase this convenience still further.

The visualisation is able to run on WINDOWS systems from WINDOWS 98SE to WINDOWS XP (with the exception of Windows NT). Your operating environment always retains the XP style.

EIB editor – the ETS interface

The main task of the EIB editor is to create the connection between the Facility-Pilot and the KNX. This editor can be used for a quick, convenient import of data from the ETS projects into the Facility-Pilot. For connection to KNX, the system uses the EIBA Falcon driver. No additional software is needed. The KNX group addresses can be allocated either automatically by drag & drop or manually. Start group functions make it easy for the user to stipulate differentiated start behaviour of the system (Fig. C).

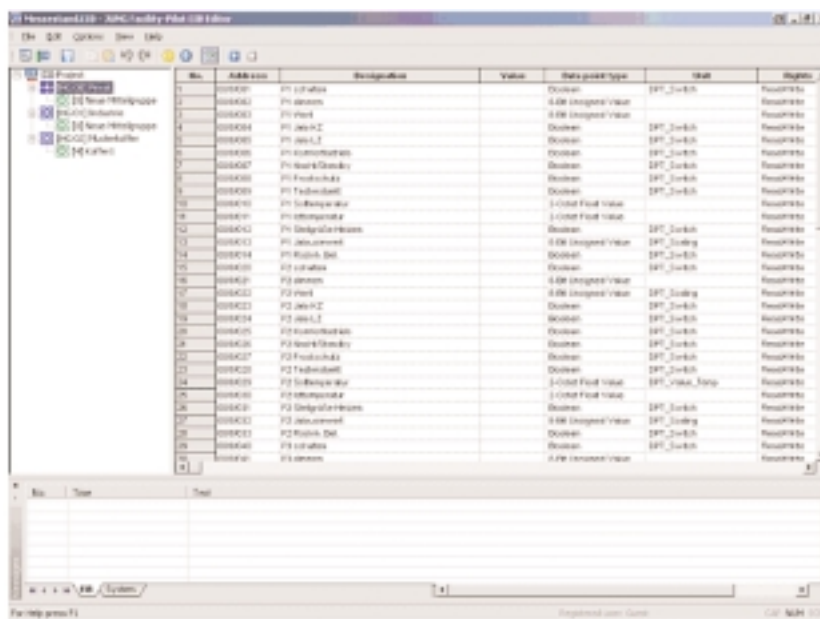

Fig. C

In addition, the EIB editor works as a diagnosis tool in the system. For example, it assumes evaluation of the KNX telegrams and shows them in plain text. This gives the user perfect control of the bus system. I.e. it is not necessary to switch over between ETS and Facility Pilot to test or record data points, everything can be done within the EIB editor module.

OPC editor – the open interface

An OPC client which analyses which OPC servers are installed in the system (there can be several) is available as an option in the Facility-Pilot package. The client reads out the data from the OPC servers and makes it available to the process model. It can execute this in parallel with the EIB Editor.

Additional data from other processes e.g. LON or M-Bus can thus be linked with a KNX installation and visualised in a simple way.

Planners and installers know that these requirements are found with increasing frequency in projects.

In practice, this can appear as follows: in parallel to the KNX process connection, an OPC server communicates with the LON devices located in the building and makes the data available via its software interface. The data is processed in the process model.

A link can now be implemented between the process variables.

The “forwarding function” (gateway function) is used for this purpose so that data is sent from LON to KNX and vice versa.

An additional gateway can thus be omitted since it already exists in the system.

A link to the Ethernet is also possible. The setpoint temperature or other parameters from control and instrumentation technology can for example be brought on the KNX.

Process model – comfort and safety with perfect workflows

The process model summarises the device data from the EIB editor or other physical connections and generates complete work-flows from individual functions. It is also possible to combine different sequences, e.g. blind control adjusted to the time of day and light conditions.

These functions (Fig. F) can also be adjusted to simulate the presence of people in the building when it is unoccupied.

The system thus also offers additional security. This aspect is reinforced if the KNX alarm system is integrated and controlled via the Facility-Pilot. The process model requires a logical view of the project, offering for example mathematical and time-based functions, or also scenarios and workflows for lighting control and monitoring functions. The user can easily draw up his own rules for the management of his facility.

5 Visualization / Facility Management

To this end, "virtual devices" are created on the screen, archives are defined, e-mail notifications and alarm warnings are preset. If over the weekend a previously defined temperature is exceeded for example in office rooms with Facility-Pilot monitoring, the system issues a corresponding e-mail notification. Individual process data can be recorded systematically and value progressions exported to Excel spreadsheets or displayed directly as graphs or tables (Fig. D and E). In addition the process variables can be linked with other programs via DDE. These can then be used to check the energy bills.

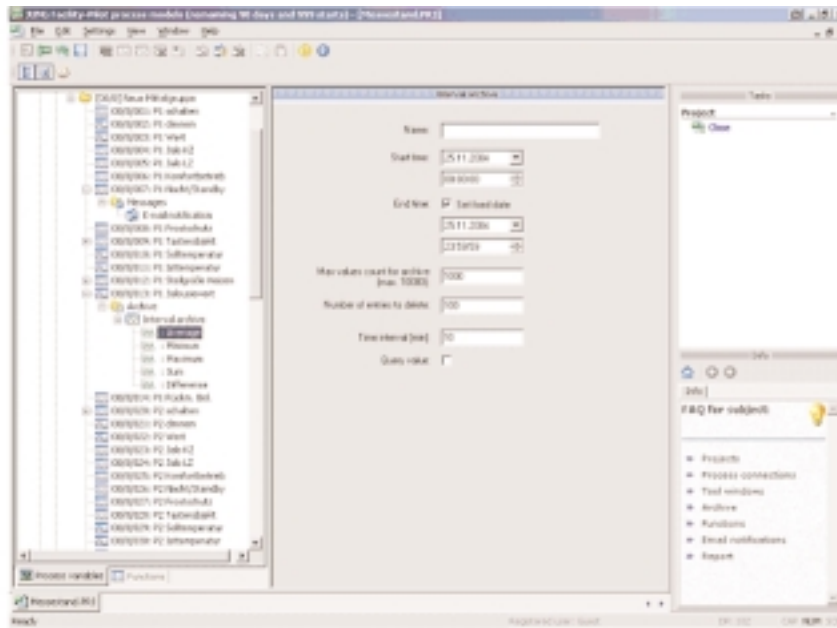

Fig. D Data processing

Values that are calculated and recorded by the process can be represented in the Visualisation Editor. Curve diagrams can also be displayed in the worksheet. The visualisation package contains the option of viewing and testing archives directly. Values are represented in table format and graphically in a diagram.

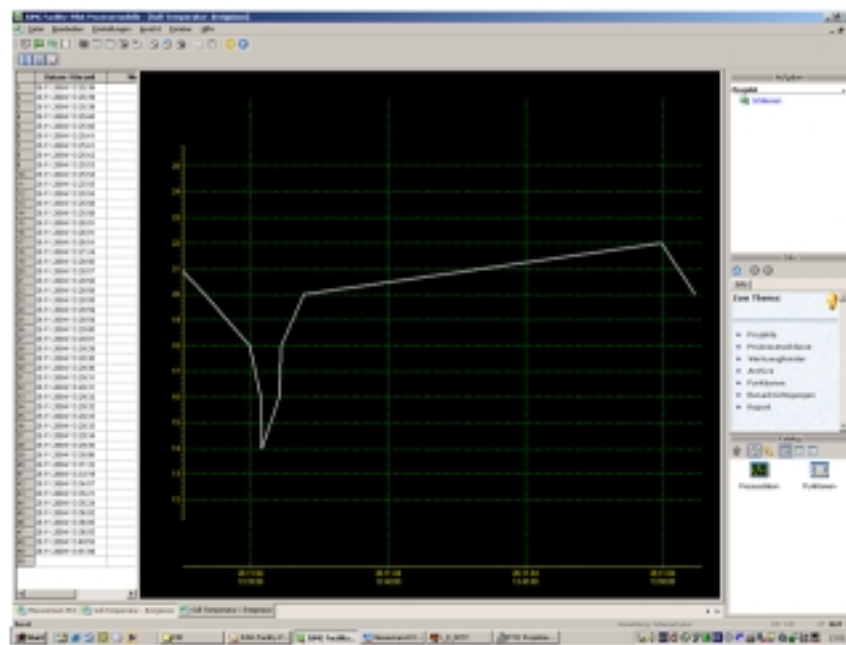

Fig. E Data recording

5 Visualization / Facility Management

The functions within the process model

The available logic functions which are created in the process model are amongst others “AND”, “OR” and “XOR”. A KNX installation can be significantly enhanced through these functions. In addition to the basic functions such as ‘AND’ and ‘OR’, there is a whole range of additional functions in the system which underline its capability. When a visualisation is logically connected, you can clearly see what effect it has (Fig. F). The following functions are the more advanced ones to realize even very complex applications:

- **Scene:** A scene is a collection of commands. When it is started, these commands are sent on the bus in no chronological order in contrast to the sequence function.
- **Sequence:** In addition to the basic functions, there is the “Sequence” function, which could be described as a smart scene. I.e. a command is only executed when a specific condition is enabled. Specific loads are switched on at the press of a button, as defined in the process model. A presence simulation can thus easily be implemented. A time stamp can likewise be inserted which can be assigned to each switch or lighting fitting. With this function, it is possible to indicate the last time that someone operated a device or entered a room.
- **Forwarding:** This gateway function is a very important function if you have two different process connections for example. If you wish to use or display a value from the heating system (OPC) in the KNX installation, you have a source value which is routed to a target value (gateway functionality). A bridge is thus created in a simple way between the process connections.
- **Status function:** The status variable takes the last reported value and simulates KNX status objects if specific KNX devices for instance do not have these status objects at their disposal.
- **Gate function** which can be implemented with the IF/THEN function: The If / Then function is used to calculate the values of process variables depending on other process variables and conditions. E.g. it can be used to configure a priority control: The value of a switch will only be sent to an actuator, when the control of the actuator by the switch has been allowed. The allowance may depend on another binary process variable.
- **Mathematic functions:** Here any basic calculation can be used within a formula. The syntax of the formula is similar to the Excel one.
- **Time delay:** For example, we switch the light on in the toilet and the fan is activated with a time delay. No further installation is required. The user has the option of setting times as required without ETS programming.
- **Automatic guard:** If you take an area of a refrigeration plant which has to be monitored, temperatures between 3° and 5° can be defined e.g. for the cold store and values of > -8° for the deep-freeze room. The visualisation takes over the task of monitoring (watchdog function) this operating state and issues an alarm when the temperature rises above or falls below the required temperatures. Specific monitoring periods can also be selected. In the event of an alarm, this is issued acoustically but it can also be routed as an e-mail (→ SMS on a mobile phone) or via fax. Alarms are verified on a list. All alarms are displayed there as “acknowledged” and “not acknowledged”.
- **Counter:** If you wish to know for example how often the burner of the heating system cycles, its starting and stopping pulses are taken as the basis. You then count how long the burner is active for. The hours and minutes of the operating time can be displayed with the help of the counter as well as the average switching time. The counter elements can be used as upwards or downwards counter.

Summarized, you can say that the system offers a number of basic functions and is equipped moreover with higher value functions such as the counter or If / Then function which could be put together from basic functions but have already been implemented without any programming work. Further modules, which do not need to be built together from basic functions, are conceivable and planned, not as a basic function but as function modules. Frequently used functions are integrated in the visualisation as virtual devices.

The process model is extended for this purpose.

In general, there are no limits for these functions or basic scripts. The only limit is the configuration of the PC where the Facility Pilot is installed.

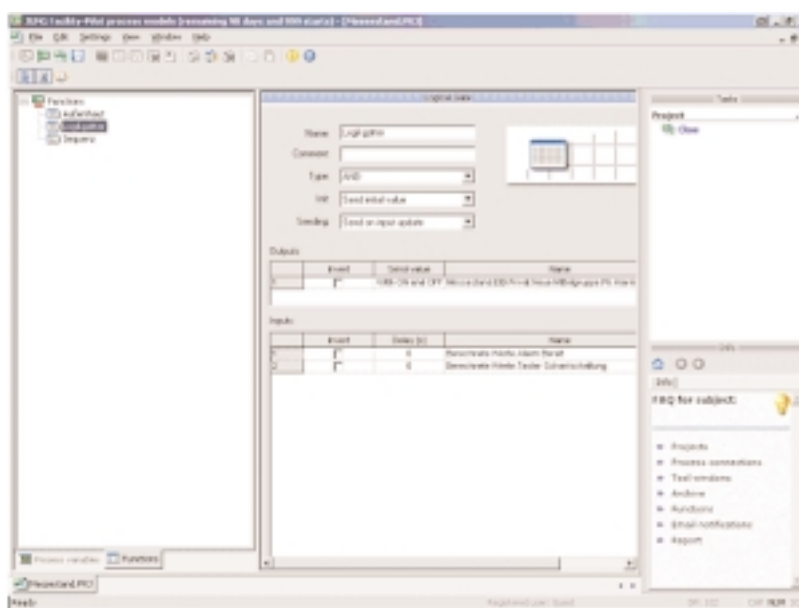

Fig. F

5 Visualization / Facility Management

Visualisation Editor

The visualisation editor presents the whole bus system as a model on the screen. The user has virtual access to devices and can make settings which apply to the bus system. The layout of the corresponding building can be shown for clear, convenient operation, and symbols for lighting, blinds or central heating can be allocated individually from an icon library. The visualisation is based on individual work sheets which can be stored in unlimited numbers in the system.

The background of the visualisation can be created with DXF, JPG, BMP, WMF or EMF formats. Thus you can offer the customer a unique visualisation which is tailor-made for his personal taste or is based on the CD/CI concept of a company.

Next to the main presentation area, the right-hand side of the screen shows a working and help section which the user can set up according to his individual needs (Fig. G).

It is very simple to work with the editor and is made even easier with functions such as undo, redo, zoom, rulers, guidelines and grid as well as several editing levels. The system is organised in three levels (planes) – the static, the dynamic and the link level, which can be shown and hidden again depending on the particular work phase.

The visualisation system is rounded off by an extensive interactive help function which the user can call up at any time.

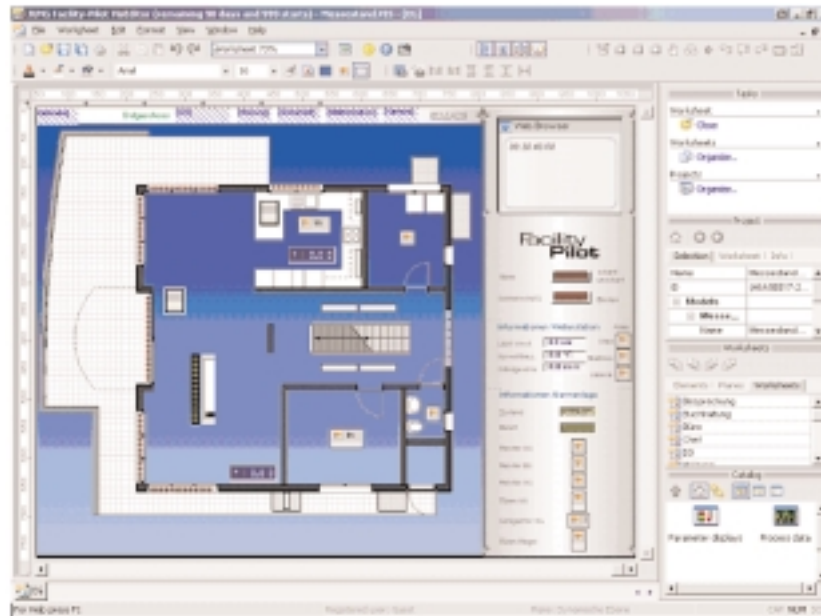

Fig. G

The visualization editor creates a report of the visualization project, the worksheets in the project, their properties and their connections to process variables. For each worksheet an image of the whole worksheet is displayed and list of the contained display elements along with their position etc.

The calendar program

The yearly calendar program is an own module for creating and configuring automatic time switch functions can be configured via drag & drop. An unlimited number of calendars can be created.

The process model to which the time program should refer is selected first of all. Then various daily programs are created for example which are given corresponding commands. In contrast to classic clocks, the system does not operate channel-specifically i.e. it is not necessary to create a unique program for each channel.

In addition, to the powerful and complex yearly calendar, a weekly timer can be implemented into the visualisation project, i. e. the customer can open the timer within the player mode and change the settings. Because it is a regular display element, similar to any lamp or push-button symbol, you can use as much weekly timer as necessary.

5 Visualization / Facility Management

Control via Internet by the web editor

The application to access the system via Internet or PDA with regular web browsers can be achieved by the web editor module. A user administration is created so that the areas to be protected by the Facility-Pilot are secured against unauthorised access. For security purposes, individual components of the system can only be made accessible to predefined user groups. The web editor allows to define and edit web projects without any HTML knowledge (Fig. H). A simple HTML visualisation can be configured with just a few clicks. A web server has been integrated into the web editor module which can dynamically generate standard HTML pages according to properties of devices and browsers. Sets of HTML pages are organised as “books” and can be assigned to users.

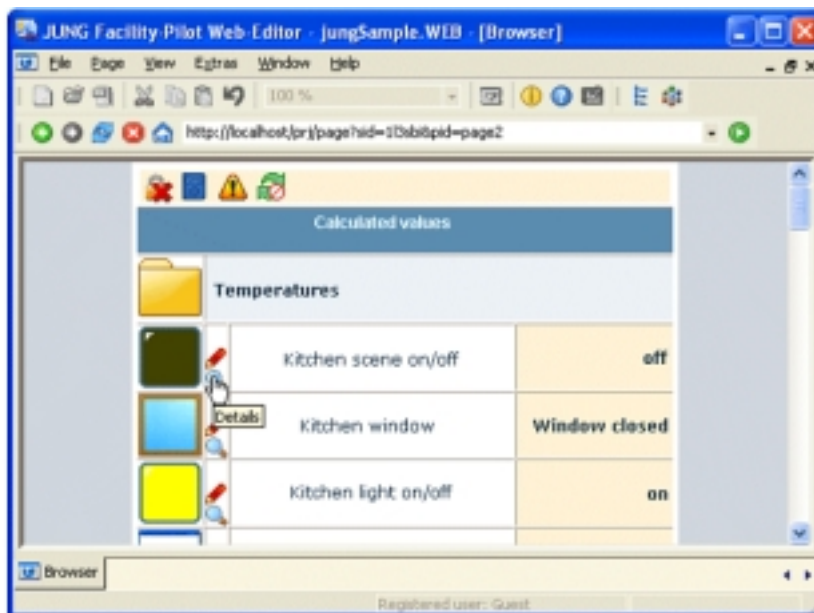

Fig. H

Network application

The network features of the Facility Pilot software are used to connect several PC's with Facility Pilot installations over a TCP/IP – network. Each PC with the Facility Pilot software installed is called a Facility Pilot station or just “station” for short. Visualisation players of several Facility Pilot stations can be connected with a process model within a remote Facility Pilot station.

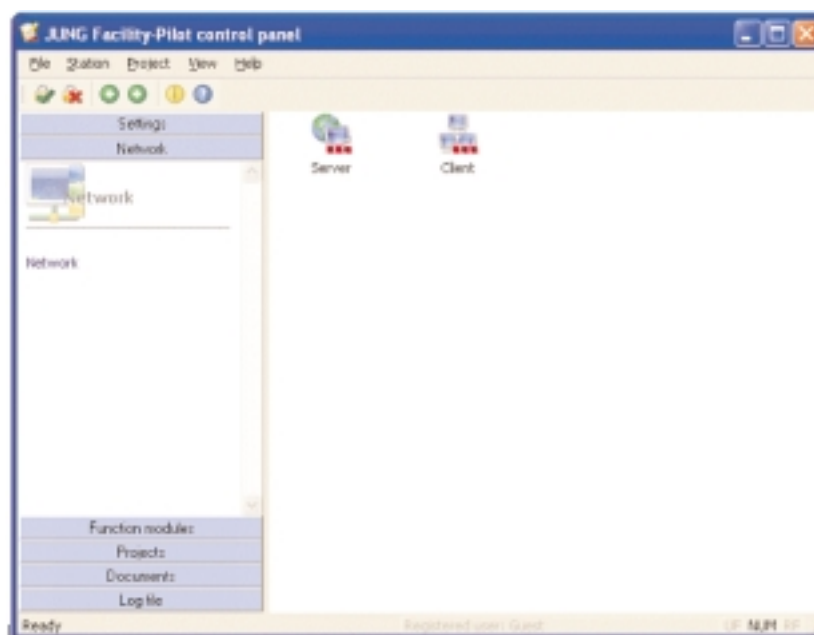

Fig. I

5 Visualization / Facility Management

The network architecture follows a client/server-model (Fig. I), with one station as the server and the other stations as clients. The server is connected to the technical process. Clients query process states from the server, to change process states they send commands to the server.

A typical application of this new network features is the connection of several touch panels with a server. The network protocol is based on TCP/IP and requires authentication with a user name and a password. Multiple client stations can be connected via TCP/IP to one server station. The maximum number of clients depends on the capabilities of the server, hardware and operating system. In some cases it may be preferable to use a WINDOWS server version. In most cases, network traffic caused by the Jung Facility-Pilot software will be quite low, since not much more than changes to the process states and keep-alive telegrams will be transmitted, In particular no graphics need to be transmitted, since the visualisation project is running at the client.

XPL editor for audio applications

There is an increasing desire to combine home and building automation with streaming of digital music. For instance lighting and music control can be integrated in scenes, which can be selected at the push of a button from anywhere in the building.

One of the best systems for audio streaming over IP networks is the Squeezebox-system from the company Slim Devices, Inc. (Fig. J). Audio streams are transmitted over Ethernet or wireless (IEEE 802.11) networks from a server with the open-source SlimServer software to Squeezebox music players, and in turn controlled by the Facility Pilot XPL editor.

Supported audio streams are for instance Internet Radio, MP3, WAV, WMA and Ogg Vorbis.

We strongly recommend not to install the SlimServer software at the PC running the Facility Pilot system, since the SlimServer could impair the proper operation of the automation system.

The XPL editor of the Facility Pilot system controls the SlimServer and in turn the Squeezebox music players via the XPL data protocol, which is standardised by the XPL project.

Among other possibilities, using the XPL editor, push buttons and dimming functions can be used to control volume, playlists etc., or messages can be displayed at the music player's display. For the indication of tracks or playlists KNX front end devices as FD RCD, colour touch panel, etc. can be used.

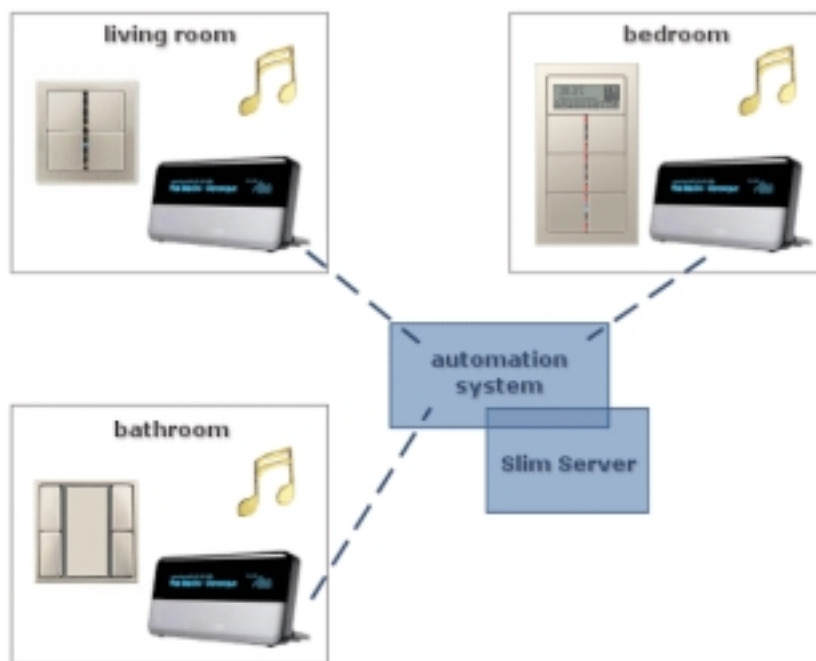

Fig. J

Visualization

Flat Panel Touch PC 15"



2

	Ref.-No.
KNX Flat Panel PC 15"	PCT 15 FAP V (German version)
	PCT 15 FAP V-GB (English version)

3 The combination of this flat touch screen and the Facility Pilot (FAP) makes it easy to control all the functions of the FAP, simply by touching the 15" TFT screen with the tip of your finger.
The housing is fitted with a high-quality aluminium frame which enables it to be installed flush with the wall.
The special flush-box is absolutely required !

4 Technical data

Screen size:	15"
Resolution:	1024 x 768 pixel
Language:	German or English
• Aluminium frame	
• Flush mounted with touch control	
• Incl. FAP – Full version (pre-installed)	
• Noiseless, without rotating parts	
Operating system:	Windows XP embedded
Processor:	800 MHz Intel Pentium M
RAM memory:	1 GB
Hard disk:	Compact Flash-memory card, 2 GB
External connections:	<ul style="list-style-type: none">• 4 x USB 2.0• 1 x Sound Line-out• 1 x 10/100 Mbit Fast Ethernet• 1 x VGA for connection of a external monitor• 1 x Mouse PS/2• 1 x keyboard PS/2
Power:	AC 230 V ~
Frame size:	420 x 340 mm (W x H)
Depth:	60 mm

4

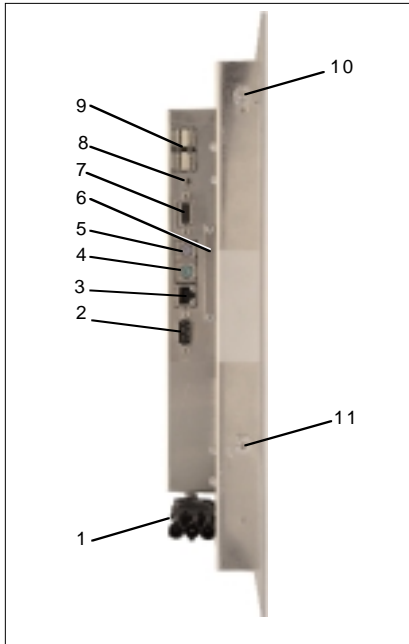

Flat-Panel PC

- 1 Connection for power supply AC 230 V ~
- 2 RS 232
- 3 10/100 Mbit Fast Ethernet
- 4 PS/2 Mouse
- 5 PS/2 keyboard
- 6 Cover for CompactFlash card 2 GB
- 7 VGA
- 8 Sound Line – out
- 9 4 x USB 2.0
- 10 2 x upper connection pin
- 11 2 x lower connection pin

5

Hardware description

Commissioning

The Flat Panel PC is pre-configured.

The writing access for drive "C" is locked.

For client-specific settings (Passwords, user, etc) the locking must be deactivated.

Activate the locking after finishing the settings.

Please refer to the manual of the Flat Panel PC to follow on the commissioning.

Facility Pilot

The Facility-Pilot is installed on drive "D" of the Flat Panel PC.

If the project is generated on a different drive than drive "D" of the system integrator PC, it will cause problems when the visualisation is imported to the Flat Panel PC. E.g. the folder with the imported images can not be found. A folder "images" will be automatically created, when a new project will be started. Images which will be used in a project have to be saved in this folder.

The visualisation automatically loads all images out of these folder. It will be assured, that all images of a project will be found.

No subfolder will be provided in the image folder.



2	Flush-box	Ref.-No.
		PCT 15 EBG
	Metal box for flush mounting the KNX Flat Panel PC Art.-Nr.: PCT 15 FAP V Dimensions 320 x 400 x 100 mm (W x H x D)	

4 Assembling

Mounting in hollow wall

Dimension for cut-out: Width: 400 mm / Height: 318 mm.

Connect the flush box with the clamps (2).

Clamps for wall thickness of approx. 10 – 30 mm.

Fixing clamps for solid walls are not required.

Push the required cables through the provided gaskets into the flush box.

Close all unused cable ducts with gaskets.

Mounting in solid walls

Connect the 4 fixing claws for solid walls (1) with the enclosed screws to the flush box.

Push the required cables through the provided gaskets into the flush box.

Close all unused cable ducts with gaskets.

Close all holes with duct tape.

Intruding cement or plaster can cause damage to the housing or mechanical parts.

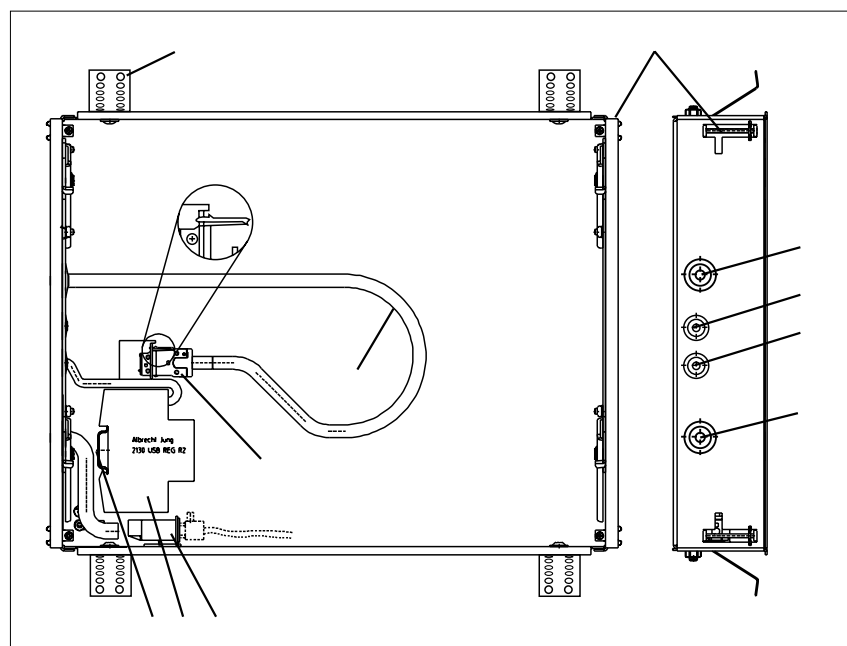

- 1 4 x fixing clamps for solid walls (not pre-assembled)
- 2 4 x clamps (for hollow wall mounting)
- 3 Cable duct for 10/100 Mbit fast Ethernet
- 4 Cable duct for USB connection
- 5 Cable duct for KNX Bus connection
- 6 Cable duct for power supply AC 230 V ~
- 7 Connection for power supply
- 8 USB data interface (optional)
- 9 Rail for REG devices
- 10 Cat. 6 RJ 45 Modular Jack (optional)
- 11 Bending radius (11) for LAN cable according to cable manufacturer

System Accessories

1

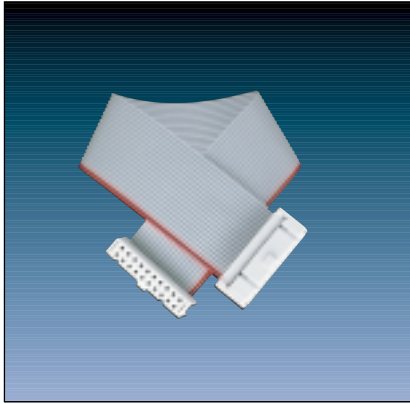

2

	Ref.-No.
Ribbon cable, 20-poles for connection of control units and panels	
length 300 mm	2450.300
length 500 mm	2450.500

1

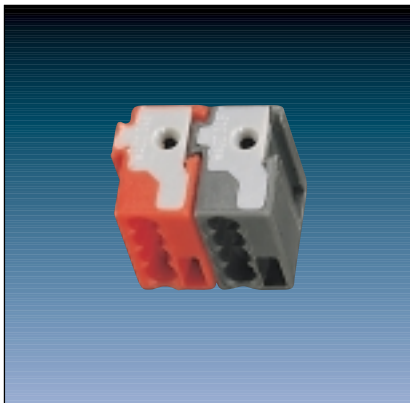

2

	Ref.-No.
KNX Bus connection block	
2 poles, 4 connection points	2050 RT SW
ETS-product family:	System accessories
Product type:	Connection block
Plug-in connections (screwless) 2 x 4 0.6 ... 0.8 mm single core	

1



2

	Ref.-No.
Radio-controlled	
wall-mounted transmitter	40 FW

3

Installation into standard wall box or with surface cap.

Range: 100 m (free field).

Battery-operated with two lithium button cells (CR2032) which are included.

Battery life: approx. 3 years.

The wall-mounted transmitter is operated in combination with standard push-button sensors (1-gang, 2-gang or 4-gang) of the KNX range.

After the push-button sensor is pressed, the transmitter sends a radio telegram which is understood and evaluated by all the receivers of the Radio Management system and the KNX-Radio gateways (ref.-no. 2700 AP, ..2094 F.).

Possible modes: on/off, dimming, light scene, central off (to be selected by microswitches).

The number of radio channels is dependent on the push-button sensor in use e.g. 1-gang push-button sensor = 1-channel radio-controlled wall-mounted transmitter. Each set of facing push-buttons belongs to one channel.

Accessories

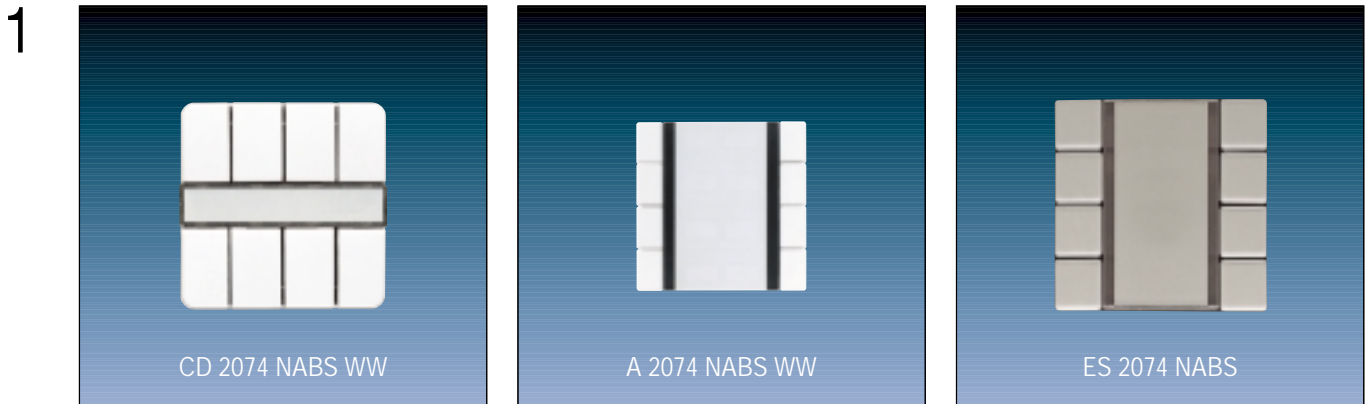

2

	Ref.-No.
Push-button sensor for radio-controlled wall-mounted transmitter 40 FW	
for ranges CD 500 + CD plus	
1-gang (1-channel transmission)	CD 2071 NABS..
2-gang (2-channel transmission)	CD 2072 NABS..
4-gang (4-channel transmission)	CD 2074 NABS..
for ranges LS 990 + LS plus	
1-gang (1-channel transmission)	LS 2071 NABS..
2-gang (2-channel transmission)	LS 2072 NABS..
4-gang (4-channel transmission)	LS 2074 NABS..
for ranges Stainless Steel + LS plus	
1-gang (1-channel transmission)	ES 2071 NABS
2-gang (2-channel transmission)	ES 2072 NABS
4-gang (4-channel transmission)	ES 2074 NABS
for ranges Aluminium + LS plus	
1-gang (1-channel transmission)	AL 2071 NABS
2-gang (2-channel transmission)	AL 2072 NABS
4-gang (4-channel transmission)	AL 2074 NABS
for ranges Anthracite + LS plus	
1-gang (1-channel transmission)	AL 2071 NABS AN
2-gang (2-channel transmission)	AL 2072 NABS AN
4-gang (4-channel transmission)	AL 2074 NABS AN
for ranges Gold + LS plus	
1-gang (1-channel transmission)	GO 2071 NABS
2-gang (2-channel transmission)	GO 2072 NABS
4-gang (4-channel transmission)	GO 2074 NABS
Chrome + LS plus	
1-gang (1-channel transmission)	GCR 2071 NABS
2-gang (2-channel transmission)	GCR 2072 NABS
4-gang (4-channel transmission)	GCR 2074 NABS

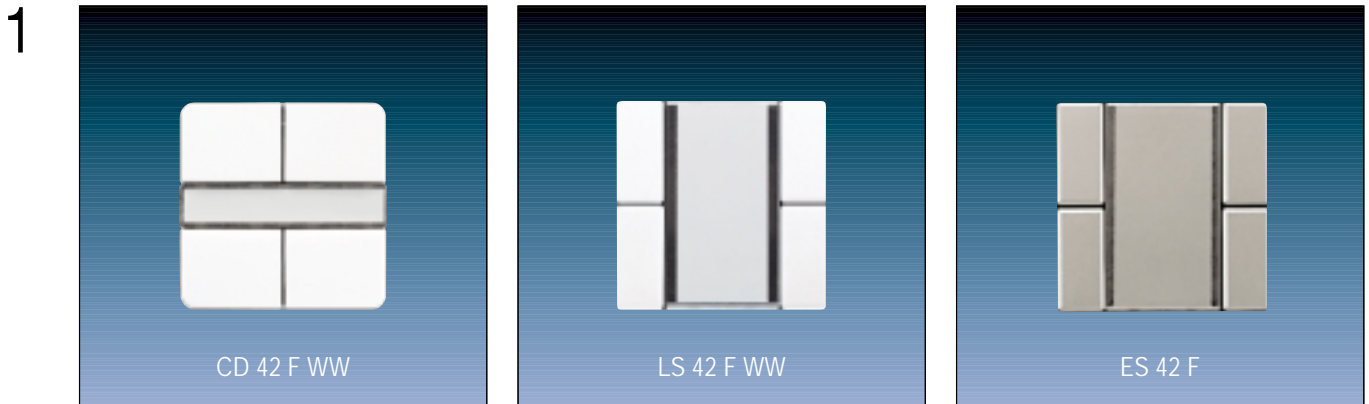

2

		Ref.-No.			
"Flat" radio-controlled wall-mounted transmitter					
for ranges AS / A 500 + A plus			for ranges CD 500 + CD plus		
1-channel	ivory	A 41 F	1-channel	ivory	CD 41 F
	white	A 41 F WW		white	CD 41 F WW
	aluminium	A 41 F AL	2-channel	ivory	CD 42 F
2-channel	ivory	A 42 F		white	CD 42 F WW
	white	A 42 F WW	4-channel	ivory	CD 44 F
	aluminium	A 42 F AL		white	CD 44 F WW
4-channel	ivory	A 44 F			
	white	A 44 F WW			
	aluminium	A 44 F AL			
for ranges LS 990 + LS plus			for ranges Stainless Steel + LS plus		
1-channel	ivory	LS 41 F	1-channel	stainless steel	ES 41 F
	white	LS 41 F WW	2-channel	stainless steel	ES 42 F
	light grey	LS 41 F LG	4-channel	stainless steel	ES 44 F
	black	LS 41 F SW			
2-channel	ivory	LS 42 F	for ranges Aluminium + LS plus		
	white	LS 42 F WW	1-channel	aluminium (lacquered)	AL 41 F
	light grey	LS 42 F LG	2-channel	aluminium (lacquered)	AL 42 F
	black	LS 42 F SW	4-channel	aluminium (lacquered)	AL 44 F
4-channel	ivory	LS 44 F			
	white	LS 44 F WW			
	light grey	LS 44 F LG			
	black	LS 44 F SW			

3 The "Flat" radio-controlled wall-mounted transmitter sends a radio telegram after a push-button sensor is pressed. The telegram is understood and evaluated by all the radio receivers of the Radio Management system. Possible modes: on/off, dimming, light scene, central off (to be selected by microswitches). Range: approx. 30 m (free field). Battery operation with two lithium button cells (CR 2016) which are included. Battery life: approx. 3 years. Installation is carried out with the appropriate frame directly onto a level surface (plaster, wood, glass, mirror or flush box) using adhesive or screws.

Accessories

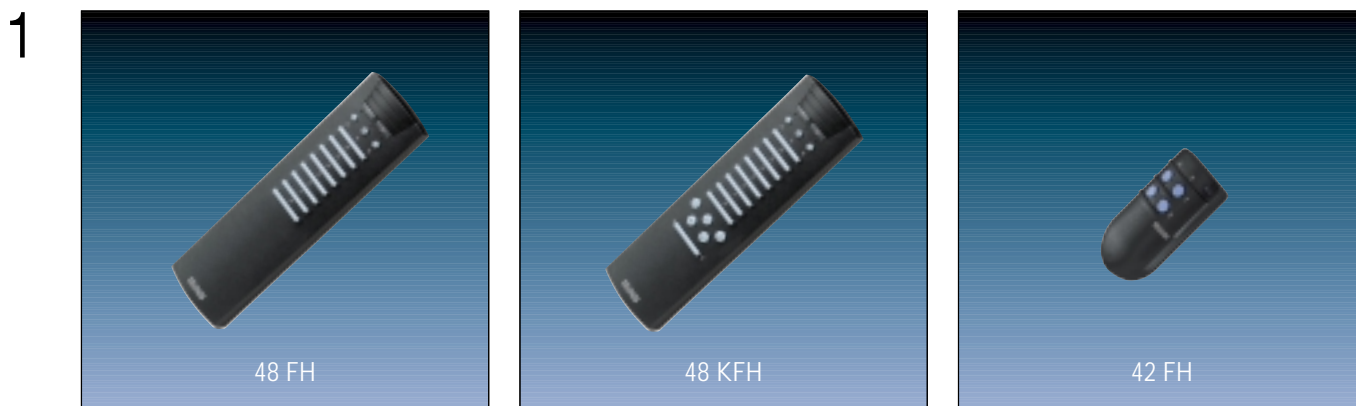

2

	Ref.-No.
Radio-controlled hand-held transmitter	
Standard version, anthracite	48 FH
Comfort version, anthracite	48 KFH
additional function: 5 light moods, master dimming	
Mini version, anthracite	42 FH

3

The hand-held transmitter sends a radio telegram after a push-button operation. This telegram is understood and evaluated by all the receivers of the Radio Management system. There are three groups available (A, B, C), each with 8 channel push-buttons (on/off – up/down – dimming) i.e. 24 radio receivers can be operated individually. Central control by ALL ON / ALL OFF buttons. Transmission range: max. 100 m (free field). The hand-held transmitter is operated with 4 x micro (AAA), alkaline (LR03) batteries (not included). Battery life: approx. 3 years.



2

	Ref.-No.
Wall-fixing for 48 FH / 48 KFH	WH 48
colour: anthracite	



2	Universal radio transmitter	Ref.-No. FUS 22 UP
---	-----------------------------	-----------------------

- 3 The radio-controlled universal transmitter serves to extend an existing installation by the wireless transmission of switching commands. The radio telegram from the radio-controlled universal transmitter is understood and evaluated by all the radio receivers of the Radio Management system. The radio-controlled universal transmitter can be operated as a switch, push-button or shutter transmitter. The control of the inputs (La, Lb) is carried out with mains voltage (AC 230 V ~).

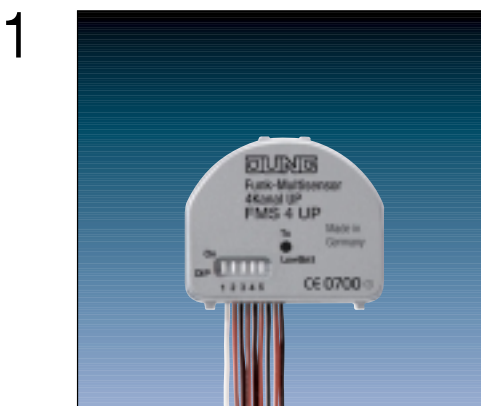

2	Radio-controlled multifunction transmitter	Ref.-No. FMS 4 UP
---	--	----------------------

- 3 The radio-controlled multifunction transmitter is a battery-operated four-channel radio transmitter for the extension of an existing radio control installation. At its four inputs the multifunction radio transmitter detects switching states of potential-free installation switches or push-buttons. It transmits radio telegrams which can be decoded by all radio control receivers. A 5-digit microswitch facilitates the selection of eight different modes of operation. A red LED indicates the transmission of radio telegrams (slow unsymmetrical blinking, 4 Hz) or an empty battery "LowBatt" (quick symmetrical blinking, 10 Hz).

Accessories

1



2

Label Tool software
(free of charge)

Ref.-No.

Download from www.jung.de

3

With the inscription tool all JUNG devices can be easily described. After input of a ref.-no. e.g. CD 2094 NABS WW the corresponding "field" is displayed on the screen. Beside text, symbols or little graphics can be typed in. The print out is on paper or foils. For the KNX push-buttons foils are recommended, as with paper the status/operation LED's are covered. The software is easy to handle, and can be downloaded from our webpage www.jung.de.

1



2

	Ref.-No.
Blank plate with snap-on fixing	
CD 500	
for individual cuttings or drillings	
ivory	594-0
white	CD 594-0 WW
blue	CD 594-0 BL
brown	CD 594-0 BR
grey	CD 594-0 GR
light grey	CD 594-0 LG
red	CD 594-0 RT
black	CD 594-0 SW

1



2

	Ref.-No.
Blank plate with snap-on fixing	
AS 500 + A 500	
for individual cuttings or drillings	
ivory	A 594-0
white	A 594-0 WW
aluminium	A 594-0 AL

Accessories

1

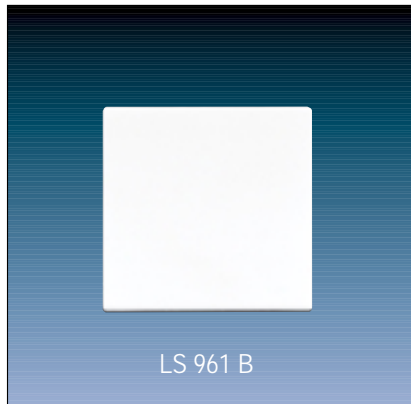

2

	Ref.-No.
Blank plate	
LS 990	
ivory	LS 961 B
white	LS 961 B WW
light grey	LS 961 B LG

1



2

	Ref.-No.
Blank plate	
Stainless Steel	
stainless steel	ES 2961 B
Aluminium	
aluminium	AL 2961 B
Anthracite	
anthracite	AL 2961 B AN
Gold	
gold coloured	GO 2961 B

1



2

		Ref.-No.
Cover frames A 500		
for horizontal and vertical combinations		
white	1-gang	A 581 WW
	2-gang	A 582 WW
	3-gang	A 583 WW
	4-gang	A 584 WW
	5-gang	A 585 WW
aluminium	1-gang	A 581 AL
	2-gang	A 582 AL
	3-gang	A 583 AL
	4-gang	A 584 AL
	5-gang	A 585 AL
Cover frames AS 500		
for horizontal and vertical combinations		
ivory	1-gang	AS 581
	2-gang	AS 582
	3-gang	AS 583
	4-gang	AS 584
	5-gang	AS 585
white	1-gang	AS 581 WW
	2-gang	AS 582 WW
	3-gang	AS 583 WW
	4-gang	AS 584 WW
	5-gang	AS 585 WW

Accessories

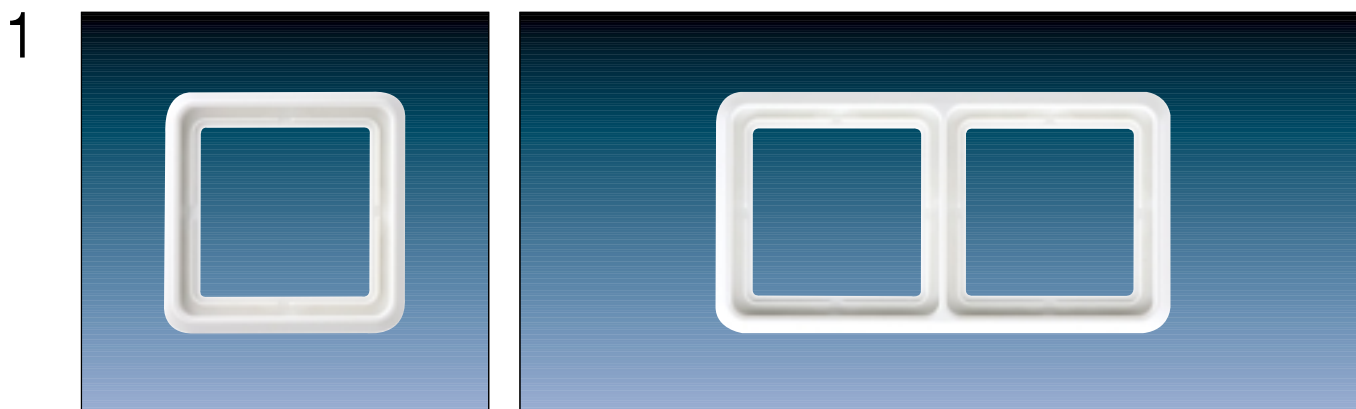

2

		Ref.-No.
Cover frames CD 500		
for horizontal and vertical combinations		
ivory	1-gang	CD 581 W
	2-gang	CD 582 W
	3-gang	CD 583 W
	4-gang	CD 584 W
	5-gang	CD 585 W
white	1-gang	CD 581 WW
	2-gang	CD 582 WW
	3-gang	CD 583 WW
	4-gang	CD 584 WW
	5-gang	CD 585 WW
blue	1-gang	CD 581 BL
	2-gang	CD 582 BL
	3-gang	CD 583 BL
	4-gang	CD 584 BL
	5-gang	CD 585 BL
brown	1-gang	CD 581 BR
	2-gang	CD 582 BR
	3-gang	CD 583 BR
	4-gang	CD 584 BR
	5-gang	CD 585 BR
grey	1-gang	CD 581 GR
	2-gang	CD 582 GR
	3-gang	CD 583 GR
	4-gang	CD 584 GR
	5-gang	CD 585 GR
light grey	1-gang	CD 581 LG
	2-gang	CD 582 LG
	3-gang	CD 583 LG
	4-gang	CD 584 LG
	5-gang	CD 585 LG
red	1-gang	CD 581 RT
	2-gang	CD 582 RT
	3-gang	CD 583 RT
	4-gang	CD 584 RT
	5-gang	CD 585 RT
black	1-gang	CD 581 SW
	2-gang	CD 582 SW
	3-gang	CD 583 SW
	4-gang	CD 584 SW
	5-gang	CD 585 SW

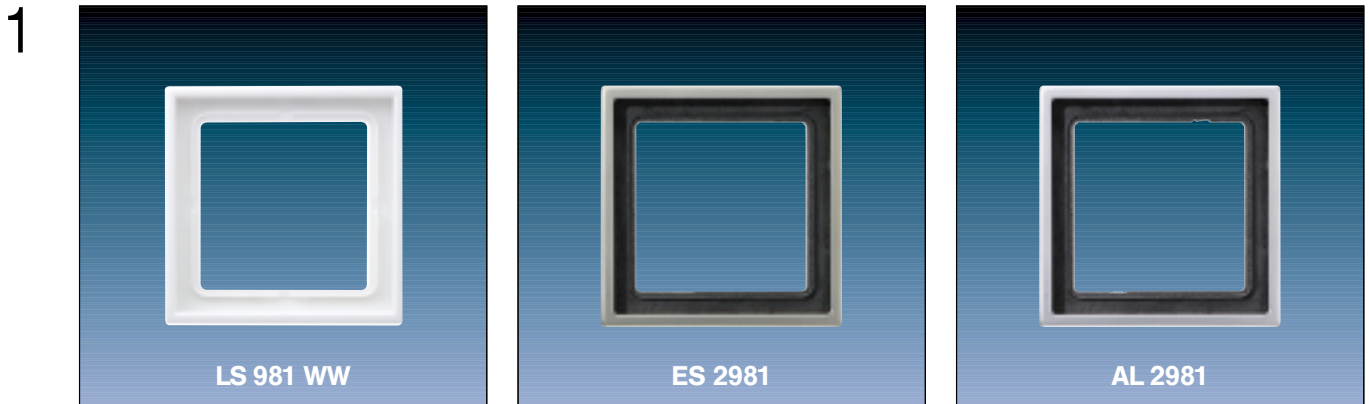

2

	Ref.-No.	
Cover frames		
for horizontal and vertical combinations		
LS 990		
ivory	1-gang	LS 981 W
	2-gang	LS 982 W
	3-gang	LS 983 W
	4-gang	LS 984 W
	5-gang	LS 985 W
white	1-gang	LS 981 WW
	2-gang	LS 982 WW
	3-gang	LS 983 WW
	4-gang	LS 984 WW
	5-gang	LS 985 WW
light grey	1-gang	LS 981 LG
	2-gang	LS 982 LG
	3-gang	LS 983 LG
	4-gang	LS 984 LG
	5-gang	LS 985 LG
Stainless Steel		
stainless steel	1-gang	ES 2981
	2-gang	ES 2982
	3-gang	ES 2983
	4-gang	ES 2984
	5-gang	ES 2985
Aluminium		
aluminium	1-gang	AL 2981
	2-gang	AL 2982
	3-gang	AL 2983
	4-gang	AL 2984
	5-gang	AL 2985

Accessories

1

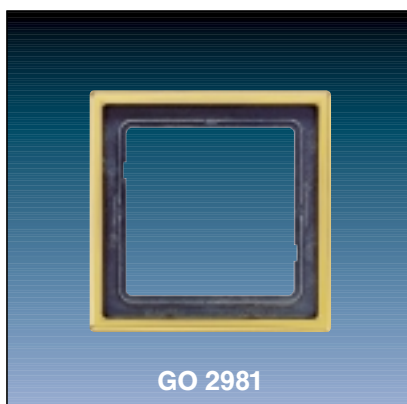

2

Ref.-No.

Cover frames

for horizontal and vertical combinations

Anthracite

anthracite	1-gang	AL 2981 AN
	2-gang	AL 2982 AN
	3-gang	AL 2983 AN
	4-gang	AL 2984 AN
	5-gang	AL 2985 AN

Gold

gold	1-gang	GO 2981
	2-gang	GO 2982
	3-gang	GO 2983
	4-gang	GO 2984
	5-gang	GO 2985

Chrome

chrome	1-gang	GCR 2981
	2-gang	GCR 2982
	3-gang	GCR 2983
	4-gang	GCR 2984
	5-gang	GCR 2985

1



2

Ref.-No.

Cover frames A plus

Frames for horizontal and vertical installation

Aluminium (lacquered)	1-gang	AP 581 AL
	2-gang	AP 582 AL
	3-gang	AP 583 AL
	4-gang	AP 584 AL
	5-gang	AP 585 AL

Shiny chrome-aluminium	1-gang	AP 581 GCR AL
	2-gang	AP 582 GCR AL
	3-gang	AP 583 GCR AL
	4-gang	AP 584 GCR AL
	5-gang	AP 585 GCR AL

Shiny chrome-white	1-gang	AP 581 GCR WW
	2-gang	AP 582 GCR WW
	3-gang	AP 583 GCR WW
	4-gang	AP 584 GCR WW
	5-gang	AP 585 GCR WW

Anthracite-aluminium	1-gang	AP 581 ANT AL
	2-gang	AP 582 ANT AL
	3-gang	AP 583 ANT AL
	4-gang	AP 584 ANT AL
	5-gang	AP 585 ANT AL

Blue-aluminium	1-gang	AP 581 BL AL
	2-gang	AP 582 BL AL
	3-gang	AP 583 BL AL
	4-gang	AP 584 BL AL
	5-gang	AP 585 BL AL

Accessories

1



2

Ref.-No.

Cover frames A plus

Frames for horizontal and vertical installation

aluminium	1-gang	AP 581 AL
	2-gang	AP 582 AL
	3-gang	AP 583 AL
	4-gang	AP 584 AL
	5-gang	AP 585 AL
anthracite-aluminium	1-gang	AP 581 ANT AL
	2-gang	AP 582 ANT AL
	3-gang	AP 583 ANT AL
	4-gang	AP 584 ANT AL
	5-gang	AP 585 ANT AL
blue-aluminium	1-gang	AP 581 BL AL
	2-gang	AP 582 BL AL
	3-gang	AP 583 BL AL
	4-gang	AP 584 BL AL
	5-gang	AP 585 BL AL
chrome-aluminium	1-gang	AP 581 GCR AL
	2-gang	AP 582 GCR AL
	3-gang	AP 583 GCR AL
	4-gang	AP 584 GCR AL
	5-gang	AP 585 GCR AL
	5-gang	AP 585 AL WW

1



2

		Ref.-No.
Cover frames A plus		
Frames for horizontal and vertical installation		
aluminium-white	1-gang	AP 581 AL WW
	2-gang	AP 582 AL WW
	3-gang	AP 583 AL WW
	4-gang	AP 584 AL WW
	5-gang	AP 585 AL WW
anthracite-white	1-gang	AP 581 ANT WW
	2-gang	AP 582 ANT WW
	3-gang	AP 583 ANT WW
	4-gang	AP 584 ANT WW
	5-gang	AP 585 ANT WW
blue-white	1-gang	AP 581 BL WW
	2-gang	AP 582 BL WW
	3-gang	AP 583 BL WW
	4-gang	AP 584 BL WW
	5-gang	AP 585 BL WW
chrome-white	1-gang	AP 581 GCR WW
	2-gang	AP 582 GCR WW
	3-gang	AP 583 GCR WW
	4-gang	AP 584 GCR WW
	5-gang	AP 585 GCR WW
white	1-gang	AP 581 BF WW
	2-gang	AP 582 BF WW
	3-gang	AP 583 BF WW
	4-gang	AP 584 BF WW
	5-gang	AP 585 BF WW

Accessories

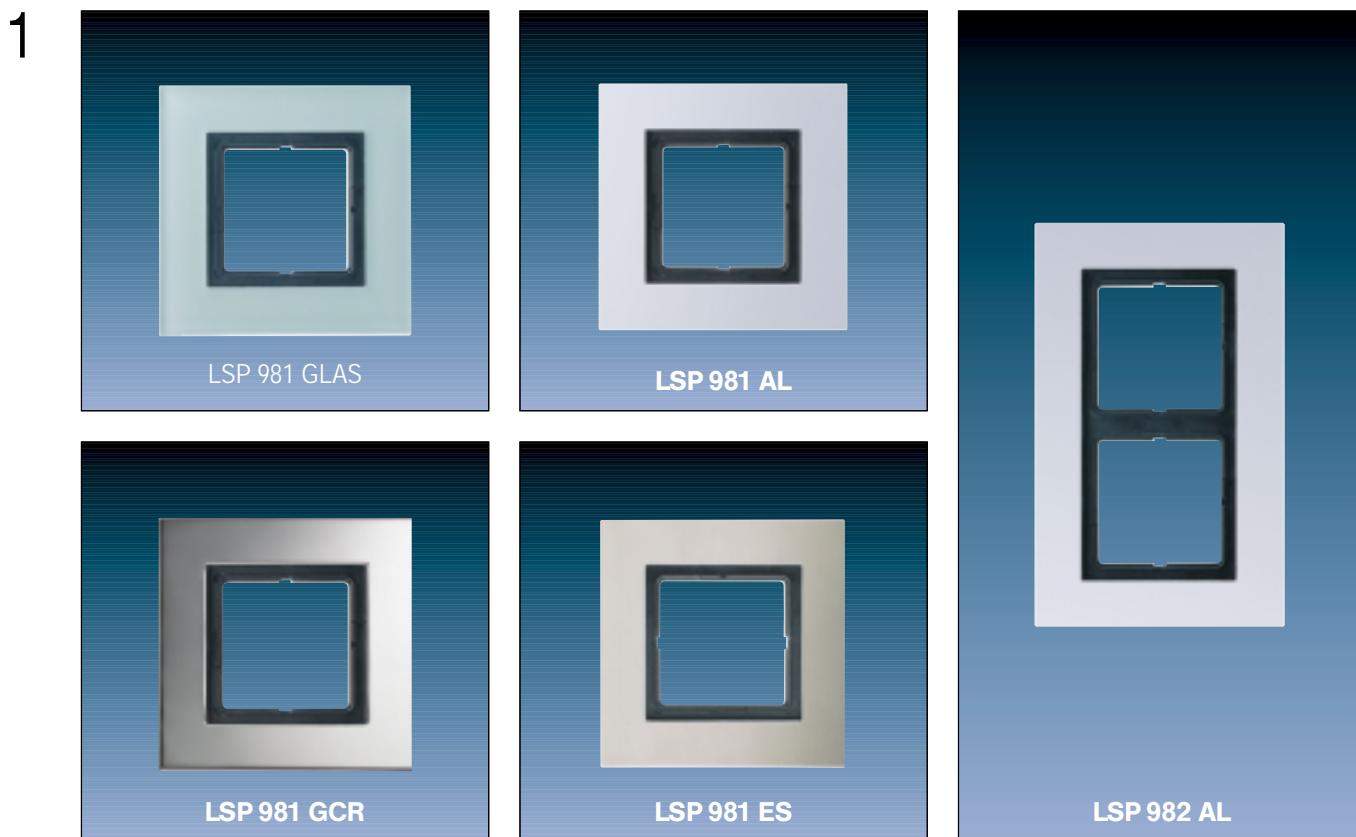

2

		Ref.-No.
Cover frames LS plus		
Frames for horizontal and vertical installation		
Glass		
Single thickness safety glass accord. to DIN 1249		
surface satin-coated, back surface lacquered in white		
	1-gang	LSP 981 GLAS
	2-gang	LSP 982 GLAS
	3-gang	LSP 983 GLAS
	4-gang	LSP 984 GLAS
	5-gang	LSP 985 GLAS
Aluminium	1-gang	LSP 981 AL
	2-gang	LSP 982 AL
	3-gang	LSP 983 AL
	4-gang	LSP 984 AL
	5-gang	LSP 985 AL
Stainless Steel	1-gang	LSP 981 ES
	2-gang	LSP 982 ES
	3-gang	LSP 983 ES
	4-gang	LSP 984 ES
	5-gang	LSP 985 ES
Shiny chrome	1-gang	LSP 981 GCR
	2-gang	LSP 982 GCR
	3-gang	LSP 983 GCR
	4-gang	LSP 984 GCR
	5-gang	LSP 985 GCR

Index

Ref.no.	page	Ref.no.	page	Ref.no.	page	Ref.no.	page
2002 REG	12	3078 TSM	32	AL 2178	100	ES 2074 NABS	46
2005 REG	14	3091 TSM	33	AL 2178 AN	100	ES 2091 NABS	53
2041	208	3091 TSML	33	AL 2178 ORTS	101	ES 2092 NABS	53
2050 RT SW	262	3092 TSM	33	AL 2178 ORTS AN	101	ES 2094 F	61
2070 U	22	3092 TSML	33	AL 2178 TS	101	ES 2094 LZ	58
2071 NABS	42	3093 TSM	33	AL 2178 TS AN	101	ES 2094 NABS	54
2071.01 LED	65	3094 TSM	33	AL 2961 B	270	ES 2178	100
2071.02 LED	65	3098 TSM	33	AL 2961 B AN	270	ES 2178 ORTS	101
2072 NABS	43	3180	82	AL 2981	273	ES 2178 TS	101
2072.01 LED	66	3180-1 A	85	AL 2981 AN	274	ES 2961 B	270
2072.02 LED	66	3210 UP	186	AL 2982	273	ES 2981	273
2074 NABS	43	3280	83	AL 2982 AN	274	ES 2982	273
2076-2 T	105	3280-1 A	86	AL 2983	273	ES 2983	273
2076-4 T	105	33 ...	70	AL 2983 AN	274	ES 2984	273
2091 NABS	50	3360	89	AL 2984	273	ES 2985	273
2092 LFX	200	3360-1	91	AL 2984 AN	274	ES 3180	82
2092 NABS	50	3601 REG	189	AL 2985	273	ES 3180-1 A	85
2092 REGX	198	3602 REG	192	AL 2985 AN	274	ES 3280	83
2094 F	61	3704 REGHE	195	AL 3180	82	ES 3280-1 A	86
2094 LZ	58	40 FW	263	AL 3180 AN	82	ES 41 F ...	265
2094 NABS	51	42 FH	266	AL 3180-1 A	85	ES 42 F ...	265
2097 REGHE	227	48 FH	266	AL 3180-1 A AN	85	ES 44 F ...	265
2114 REG	107	48 KFH	266	AL 3280	83	ESBG 2041	224
2118 REG	107	594-0	269	AL 3280 AN	83	FAP300-GB	251
2126 REG	109	800 KO	70	AL 3280-1 A	86	FAP50-GB	251
2130	25	800 NA	70	AL 3280-1 A AN	86	FAPCLIENT14-GB	251
2130 USB	27	800 NT	70	AL 41 F ...	265	FAPCLIENT1024-GB	251
2130 USB REG	26	800 P	70	AL 42 F ...	265	FAPCLIENT59-GB	251
2131 REG	24	805 MP	71	AL 44 F ...	265	FAP-PLANER GB	251
2131.16 UP	146	805 NT	71	ALBG 2041 ...	224	FAPVOLL-GB	251
2132.16 REG	150	805 P	71	AP 581 ...	275 – 277	FD 901 TSA	36
2132.6 UP	146	8071.01 LED W	68	AS 581 ...	271	FD 901 TSA LG	36
2136 REGHZ	206	8071.02 LED W	68	AS 582 ...	271	FD 901 TSA WW	36
2136.6 REG	152	8072.01 LED W	69	AS 583 ...	271	FD 901 TSANA	37
2142 REG	20	8072.02 LED W	69	AS 584 ...	271	FD 901 TSANA LG	37
2145 REGX	23	A 2071 NABS ...	48	AS 585 ...	271	FD 901 TSANA WW	37
2152 REG	136	A 2072 NABS ...	49	BG 2041	224	FD 901 TSAP	36
2154 DCF	145	A 2074 NABS ...	49	BGA 12 AH	18	FD 901 TSAP LG	36
2154 EEPROM	145	A 2091 NABS ...	56	CD 2041 ...	208	FD 901 TSAP WW	36
2154 PC	145	A 2092 NABS ...	56	CD 2071 NABS ...	42	FD 902 TSA	37
2154 REG	138	A 2094 LZ ...	59	CD 2072 NABS ...	43	FD 902 TSA LG	37
2156 REG	142	A 2094 NABS ...	56	CD 2074 NABS ...	43	FD 902 TSA WW	37
2160 REG	97	A 2178 AL ...	100	CD 2091 NABS ...	50	FD 902 TSANA	38
2176 SV	204	A 2178 ORTS ...	101	CD 2092 NABS ...	50	FD 902 TSANA LG	38
2178	100	A 2178 TS ...	101	CD 2094 F ...	61	FD 902 TSANA WW	38
2178 ORTS	101	A 2800 IR	221	CD 2094 LZ ...	58	FD 902 TSAP	38
2178 TS	100	A 3180 ...	82	CD 2094 NABS ...	51	FD 902 TSAP LG	38
2193 REG	201	A 3180-1 A ...	85	CD 2130 ...	25	FD 902 TSAP WW	38
2204 REGHR	182	A 3280 ...	83	CD 2178 ...	100	FD 904 TSA	39
2204.01 REGA	131	A 3280-1 A ...	86	CD 2178 ORTS ...	101	FD 904 TSA LG	39
2204.01 REGAM	135	A 41 F ...	265	CD 2178 TS ...	101	FD 904 TSA WW	39
2214 REGAM	124	A 42 F ...	265	CD 3180 ...	82	FD 904 TSANA	40
2214 REGA	116	A 44 F ...	265	CD 3180-1 A ...	85	FD 904 TSANA LG	40
2224 REGH	171	A 581 ...	271	CD 3280 ...	83	FD 904 TSANA WW	40
2224 REGW	119	A 582 ...	271	CD 3280-1 A ...	86	FD 904 TSAP	39
2231 UP	168	A 583 ...	271	CD 41 F ...	265	FD 904 TSAP LG	39
2304.16 REGCHM	160	A 584 ...	271	CD 42 F ...	265	FD 904 TSAP WW	39
2304.16 REGHM	155	A 585 ...	271	CD 44 F ...	265	FD 981 ...	41
2308.16 REGCHM	160	A 594-0 ...	269	CD 581 ...	272	FD 981 Z	40
2308.16 REGHE	162	ABG 2041 ...	224	CD 582 ...	272	FD 982 ...	41
2308.16 REGHM	155	AL 2041	208	CD 583 ...	272	FD 983 ...	41
2316.16 REGHE	162	AL 2041 AN	208	CD 584 ...	272	FDAL 2901 TSA	36
2405	246	AL 2071 NABS	45	CD 585 ...	272	FDAL 2901 TSA AN	36
2410	246	AL 2071 NABS AN	45	CD 594-0 ...	269	FDAL 2901 TSANA	37
2415	246	AL 2072 NABS	46	CDBG 2041 ...	224	FDAL 2901 TSANA AN	37
2422 A ... 2426 A	248	AL 2072 NABS AN	46	DAS 4110	244	FDAL 2901 TSAP	36
2422 U ... 2426 U	248	AL 2074 NABS	46	DAS 4120	244	FDAL 2901 TSAP AN	36
2430 REG	249	AL 2074 NABS AN	46	DAS 4210	245	FDAL 2902 TSA	37
2447 REG	250	AL 2091 NABS	53	DAS 4300 A	245	FDAL 2902 TSA AN	37
2450.300	262	AL 2091 NABS AN	53	DAS 4300 U	245	FDAL 2902 TSANA	38
2450.500	262	AL 2092 NABS	53	DAS 4360	245	FDAL 2902 TSANA AN	38
2504 REGHE	174	AL 2092 NABS AN	53	DAS 4370	245	FDAL 2902 TSAP	38
2601	217	AL 2094 F	61	DAS 4610	244	FDAL 2902 TSAP AN	38
2700 AP	219	AL 2094 F AN	61	EAM 4000	241	FDAL 2904 TSA	39
3071 TSM	30	AL 2094 LZ	58	EBG 24	216	FDAL 2904 TSA AN	39
3072 TSM	30	AL 2094 LZ AN	58	ES 2041	208	FDAL 2904 TSANA	40
3073 TSM	32	AL 2094 NABS	54	ES 2071 NABS	45	FDAL 2904 TSANA AN	40
3074 TSM	32	AL 2094 NABS AN	54	ES 2072 NABS	46	FDAL 2904 TSAP	39

Index

Ref.no.	page	Ref.no.	page	Ref.no.	page	Ref.no.	page
FDAL 2904 TSAP AN	39	LS 2041 ...	208	WSSV 10	125		
FDAL 2981	41	LS 2071 NABS ...	45				
FDAL 2981 AN	41	LS 2072 NABS ...	46				
FDAL 2982	41	LS 2074 NABS ...	46				
FDAL 2982 AN	41	LS 2091 NABS ...	53				
FDAL 2983	41	LS 2092 NABS ...	53				
FDAL 2983 AN	41	LS 2094 F ...	61				
FDES 2901 TSA	36	LS 2094 LZ ...	58				
FDES 2901 TSANA	37	LS 2094 NABS ...	54				
FDES 2901 TSAP	36	LS 2178 ...	100				
FDES 2902 TSA	37	LS 2178 ORTS ...	101				
FDES 2902 TSANA	38	LS 2178 TS ...	101				
FDES 2902 TSAP	38	LS 3180 ...	82				
FDES 2904 TSA	39	LS 3180-1 A ...	85				
FDES 2904 TSANA	40	LS 3280 ...	83				
FDES 2904 TSAP	39	LS 3280-1 A ...	86				
FDES 2981	41	LS 41 F ...	265				
FDES 2982	41	LS 42 F ...	265				
FDES 2983	41	LS 44 F ...	265				
FMS 4 UP	267	LS 981 ...	273				
FP 701 CT	212	LS 982 ...	273				
FP 781 AN	215	LS 983 ...	273				
FPAL 781	215	LS 984 ...	273				
FPES 781	215	LS 985 ...	273				
FPGLAS 781 EX	215	LS 961 B ...	270				
FUS 22 UP	267	LSBG 2041 ...	224				
FUS 4410 BR	245	LSP 981 ...	278				
FUS 4410 WW	245	MT 701	210				
FUS 4415 WW	245	OPC-EDITOR	251				
FUS 4620	244	PCT 15 FAPV	259				
GCR 2041	208	PCT 15 FAPV-GB	259				
GCR 2071 NABS	45	PCT 15 EBG	261				
GCR 2072 NABS	46	R 24 AL	216				
GCR 2074 NABS	46	R 24 ES	216				
GCR 2091 NABS	53	R 24 SW	216				
GCR 2092 NABS	53	R 24 WW	216				
GCR 2094 F	61	RCD 2021 ...	72				
GCR 2094 LZ	58	RCD 2022 ...	72				
GCR 2094 NABS	54	RCD 2023 ...	72				
GCR 2178	100	RCD 2024 ...	72				
GCR 2178 TS	101	RCD 2044 ...	72				
GCR 2178 ORTS	101	RCD 3094 M ...	80				
GCR 2981	274	RCD 3096 M ...	80				
GCR 2982	274	RCDAL 2021	72				
GCR 2983	274	RCDAL 2021 AN	72				
GCR 2984	274	RCDAL 2022	72				
GCR 2985	274	RCDAL 2022 AN	72				
GCR 3180	82	RCDAL 2023	72				
GCR 3180-1 A	85	RCDAL 2023 AN	72				
GCR 3280	83	RCDAL 2024	72				
GCR 3280-1 A	86	RCDAL 2024 AN	72				
GCRBG 2041	224	RCDAL 2044	72				
GO 2041	208	RCDAL 2044 AN	72				
GO 2071 NABS	45	RCDAL 3094 M	80				
GO 2072 NABS	46	RCDAL 3094 M AN	80				
GO 2074 NABS	46	RCDAL 3096 M	80				
GO 2091 NABS	53	RCDAL 3096 MA N	80				
GO 2092 NABS	53	RCDES 2021	72				
GO 2094 F	61	RCDES 2022	72				
GO 2094 LZ	58	RCDES 2023	72				
GO 2094 NABS	54	RCDES 2024	72				
GO 2178	100	RCDES 2044	72				
GO 2178 TS	101	RCDES 3094 M	80				
GO 2178 ORTS	101	RCDES 3096 M	80				
GO 2961 B	270	RCDGO 2021	72				
GO 2981	274	RCDGO 2022	72				
GO 2982	274	RCDGO 2023	72				
GO 2983	274	RCDGO 2024	72				
GO 2984	274	RCDGO 2044	72				
GO 2985	274	USV 640 MA	16				
GO 3180	82	WH 48	266				
GO 3180-1 A	85	WS 10 D	129				
GO 3280	83	WS 10 H	129				
GO 3280-1 A	86	WS 10 KS	126				
GOBG 2041	224	WS 10 KSDCF	126				
IPZ 1000 REG	231	WS 10 R	128				
KSB 4	19	WS 10 T	130				
KSE 2	19	WS 10 W	127				

JUNG

B-CB-KNX07 4  011377 030589

ALBRECHT JUNG GMBH & CO. KG
Volmestraße 1
D-58579 Schalksmühle
Germany

Phone: +49.2355.806553
Fax +49.2355.806306
E-mail: mail.vka@jung.de
Internet: www.jung.de

Member of

